

To our customers,

Old Company Name in Catalogs and Other Documents

On April 1st, 2010, NEC Electronics Corporation merged with Renesas Technology Corporation, and Renesas Electronics Corporation took over all the business of both companies. Therefore, although the old company name remains in this document, it is a valid Renesas Electronics document. We appreciate your understanding.

Renesas Electronics website: <http://www.renesas.com>

April 1st, 2010
Renesas Electronics Corporation

Issued by: Renesas Electronics Corporation (<http://www.renesas.com>)

Send any inquiries to <http://www.renesas.com/inquiry>.

Notice

1. All information included in this document is current as of the date this document is issued. Such information, however, is subject to change without any prior notice. Before purchasing or using any Renesas Electronics products listed herein, please confirm the latest product information with a Renesas Electronics sales office. Also, please pay regular and careful attention to additional and different information to be disclosed by Renesas Electronics such as that disclosed through our website.
2. Renesas Electronics does not assume any liability for infringement of patents, copyrights, or other intellectual property rights of third parties by or arising from the use of Renesas Electronics products or technical information described in this document. No license, express, implied or otherwise, is granted hereby under any patents, copyrights or other intellectual property rights of Renesas Electronics or others.
3. You should not alter, modify, copy, or otherwise misappropriate any Renesas Electronics product, whether in whole or in part.
4. Descriptions of circuits, software and other related information in this document are provided only to illustrate the operation of semiconductor products and application examples. You are fully responsible for the incorporation of these circuits, software, and information in the design of your equipment. Renesas Electronics assumes no responsibility for any losses incurred by you or third parties arising from the use of these circuits, software, or information.
5. When exporting the products or technology described in this document, you should comply with the applicable export control laws and regulations and follow the procedures required by such laws and regulations. You should not use Renesas Electronics products or the technology described in this document for any purpose relating to military applications or use by the military, including but not limited to the development of weapons of mass destruction. Renesas Electronics products and technology may not be used for or incorporated into any products or systems whose manufacture, use, or sale is prohibited under any applicable domestic or foreign laws or regulations.
6. Renesas Electronics has used reasonable care in preparing the information included in this document, but Renesas Electronics does not warrant that such information is error free. Renesas Electronics assumes no liability whatsoever for any damages incurred by you resulting from errors in or omissions from the information included herein.
7. Renesas Electronics products are classified according to the following three quality grades: “Standard”, “High Quality”, and “Specific”. The recommended applications for each Renesas Electronics product depends on the product’s quality grade, as indicated below. You must check the quality grade of each Renesas Electronics product before using it in a particular application. You may not use any Renesas Electronics product for any application categorized as “Specific” without the prior written consent of Renesas Electronics. Further, you may not use any Renesas Electronics product for any application for which it is not intended without the prior written consent of Renesas Electronics. Renesas Electronics shall not be in any way liable for any damages or losses incurred by you or third parties arising from the use of any Renesas Electronics product for an application categorized as “Specific” or for which the product is not intended where you have failed to obtain the prior written consent of Renesas Electronics. The quality grade of each Renesas Electronics product is “Standard” unless otherwise expressly specified in a Renesas Electronics data sheets or data books, etc.
 - “Standard”: Computers; office equipment; communications equipment; test and measurement equipment; audio and visual equipment; home electronic appliances; machine tools; personal electronic equipment; and industrial robots.
 - “High Quality”: Transportation equipment (automobiles, trains, ships, etc.); traffic control systems; anti-disaster systems; anti-crime systems; safety equipment; and medical equipment not specifically designed for life support.
 - “Specific”: Aircraft; aerospace equipment; submersible repeaters; nuclear reactor control systems; medical equipment or systems for life support (e.g. artificial life support devices or systems), surgical implantations, or healthcare intervention (e.g. excision, etc.), and any other applications or purposes that pose a direct threat to human life.
8. You should use the Renesas Electronics products described in this document within the range specified by Renesas Electronics, especially with respect to the maximum rating, operating supply voltage range, movement power voltage range, heat radiation characteristics, installation and other product characteristics. Renesas Electronics shall have no liability for malfunctions or damages arising out of the use of Renesas Electronics products beyond such specified ranges.
9. Although Renesas Electronics endeavors to improve the quality and reliability of its products, semiconductor products have specific characteristics such as the occurrence of failure at a certain rate and malfunctions under certain use conditions. Further, Renesas Electronics products are not subject to radiation resistance design. Please be sure to implement safety measures to guard them against the possibility of physical injury, and injury or damage caused by fire in the event of the failure of a Renesas Electronics product, such as safety design for hardware and software including but not limited to redundancy, fire control and malfunction prevention, appropriate treatment for aging degradation or any other appropriate measures. Because the evaluation of microcomputer software alone is very difficult, please evaluate the safety of the final products or system manufactured by you.
10. Please contact a Renesas Electronics sales office for details as to environmental matters such as the environmental compatibility of each Renesas Electronics product. Please use Renesas Electronics products in compliance with all applicable laws and regulations that regulate the inclusion or use of controlled substances, including without limitation, the EU RoHS Directive. Renesas Electronics assumes no liability for damages or losses occurring as a result of your noncompliance with applicable laws and regulations.
11. This document may not be reproduced or duplicated, in any form, in whole or in part, without prior written consent of Renesas Electronics.
12. Please contact a Renesas Electronics sales office if you have any questions regarding the information contained in this document or Renesas Electronics products, or if you have any other inquiries.

(Note 1) “Renesas Electronics” as used in this document means Renesas Electronics Corporation and also includes its majority-owned subsidiaries.

(Note 2) “Renesas Electronics product(s)” means any product developed or manufactured by or for Renesas Electronics.

16M-BIT MASK-PROGRAMMABLE ROM

2M-WORD BY 8-BIT (BYTE MODE) / 1M-WORD BY 16-BIT (WORD MODE)

Description

The μ PD23C16300 is a 16,777,216 bits mask-programmable ROM. The word organization is selectable (BYTE mode : 2,097,152 words by 8 bits, WORD mode : 1,048,576 words by 16 bits).

The active levels of OE (Output Enable Input) can be selected with mask-option.

<R> The μ PD23C16300 is packed in 48-pin PLASTIC TSOP(I) and 48-pin PLASTIC FBGA.

Features

- Pin compatible with NOR Flash Memory
- Word organization
 - 2,097,152 words by 8 bits (BYTE mode)
 - 1,048,576 words by 16 bits (WORD mode)
- Operating supply voltage : $V_{CC} = 2.7\text{ V}$ to 3.6 V

Operating supply voltage V_{CC}	Access time ns (MAX.)	Power supply current (Active mode) mA (MAX.)	Standby current (CMOS level input) μ A (MAX.)
3.0 V \pm 0.3 V	90	30	30
3.3 V \pm 0.3 V	85		

Ordering Information

Part Number	Package
μ PD23C16300GZ-xxx-MJH	48-pin PLASTIC TSOP(I) (12 x 20) (Normal bent)
μ PD23C16300GZ-xxx-MJH-A	48-pin PLASTIC TSOP(I) (12 x 20) (Normal bent)
<R> μ PD23C16300F1-xxx-BC1-A	48-pin PLASTIC FBGA (8 x 6)

Remarks 1. xxx : ROM code suffix No.

2. Products with -A at the end of the part number are lead-free products.

The information in this document is subject to change without notice. Before using this document, please confirm that this is the latest version.
Not all products and/or types are available in every country. Please check with an NEC Electronics sales representative for availability and additional information.

Pin Configurations

/xxx indicates active low signal.

48-pin PLASTIC TSOP(I) (12 x 20) (Normal bent)

[μPD23C16300GZ-xxx-MJH]

[μPD23C16300GZ-xxx-MJH-A]

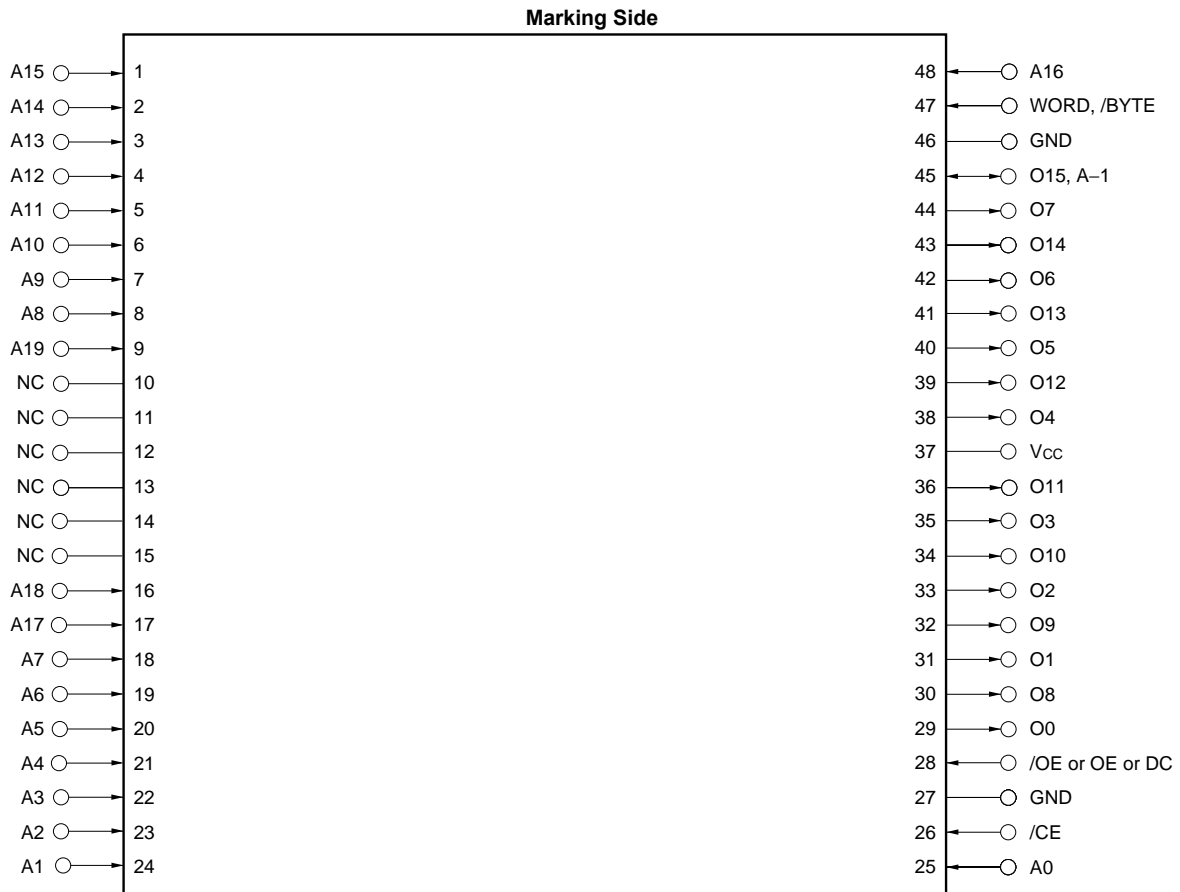

- A0 to A19 : Address inputs
- O0 to O7, O8 to O14 : Data outputs
- O15, A-1 : Data output 15 (WORD mode),
LSB Address input (BYTE mode)
- WORD, /BYTE : Mode select
- /CE : Chip Enable
- /OE or OE : Output Enable
- Vcc : Supply voltage
- GND : Ground
- NC ^{Note} : No Connection
- DC : Don't Care

Note Some signals can be applied because this pin is not connected to the inside of the chip.

Remark Refer to **Package Drawings** for the 1-pin index mark.

<R>

48-pin PLASTIC FBGA (8 x 6)

[μPD23C16300F1-xxx-BC1-A]

Top View

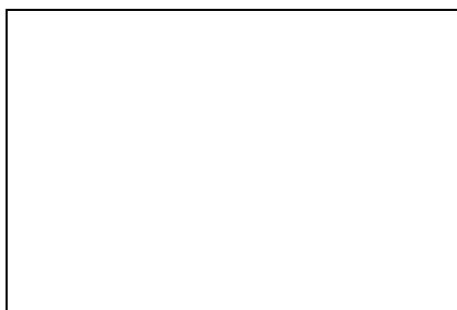

A B C D E F G H

Bottom View

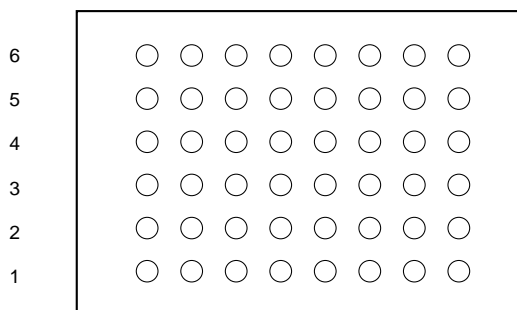

H G F E D C B A

	A	B	C	D	E	F	G	H
6	A13	A12	A14	A15	A16	WORD, /BYTE	O15, A-1	GND
5	A9	A8	A10	A11	O7	O14	O13	O6
4	NC	NC	NC	A19	O5	O12	V _{cc}	O4
3	NC	NC	A18	NC	O2	O10	O11	O3
2	A7	A17	A6	A5	O0	O8	O9	O1
1	A3	A4	A2	A1	A0	/CE	/OE or OE	GND

	H	G	F	E	D	C	B	A
6	GND	O15, A-1	WORD, /BYTE	A16	A15	A14	A12	A13
5	O6	O13	O14	O7	A11	A10	A8	A9
4	O4	V _{cc}	O12	O5	A19	NC	NC	NC
3	O3	O11	O10	O2	NC	A18	NC	NC
2	O1	O9	O8	O0	A5	A6	A17	A7
1	GND	/OE or OE	/CE	A0	A1	A2	A4	A3

- A0 to A19 : Address inputs
- O0 to O7, O8 to O14 : Data outputs
- O15, A-1 : Data output 15 (WORD mode),
LSB Address input (BYTE mode)
- WORD, /BYTE : Mode select
- /CE : Chip Enable
- /OE or OE : Output Enable
- V_{cc} : Supply voltage
- GND : Ground
- NC ^{Note} : No Connection
- DC : Don't Care

Note Some signals can be applied because this pin is not connected to the inside of the chip.

Remark Refer to **Package Drawings** for the index mark.

Input / Output Pin Functions

Pin name	Input / Output	Function
WORD, /BYTE	Input	The pin for switching WORD mode and BYTE mode. High level : WORD mode (1M-word by 16-bit) Low level : BYTE mode (2M-word by 8-bit)
A0 to A19 (Address inputs)	Input	Address input pins. A0 to A19 are used differently in the WORD mode and the BYTE mode. WORD mode (1M-word by 16-bit) A0 to A19 are used as 20 bits address signals. BYTE mode (2M-word by 8-bit) A0 to A19 are used as the upper 20 bits of total 21 bits of address signal. (The least significant bit (A-1) is combined to O15.)
O0 to O7, O8 to O14 (Data outputs)	Output	Data output pins. O0 to O7, O8 to O14 are used differently in the WORD mode and the BYTE mode. WORD mode (1M-word by 16-bit) The lower 15 bits of 16 bits data outputs to O0 to O14. (The most significant bit (O15) combined to A-1.) BYTE mode (2M-word by 8-bit) 8 bits data outputs to O0 to O7 and also O8 to O14 are high impedance.
O15, A-1 (Data output 15, LSB Address input)	Output, Input	O15, A-1 are used differently in the WORD mode and the BYTE mode. WORD mode (1M-word by 16-bit) The most significant output data bus (O15). BYTE mode (2M-word by 8-bit) The least significant address bus (A-1).
/CE (Chip Enable)	Input	Chip activating signal. When the OE is active, output states are following. High level : High-Z Low level : Data out
/OE or OE or DC (Output Enable, Don't care)	Input	Output enable signal. The active level of OE is mask option. The active level of OE can be selected from high active, low active and Don't care at order.
Vcc	-	Supply voltage
GND	-	Ground
NC	-	Not internally connected. (The signal can be connected.)

Block Diagram

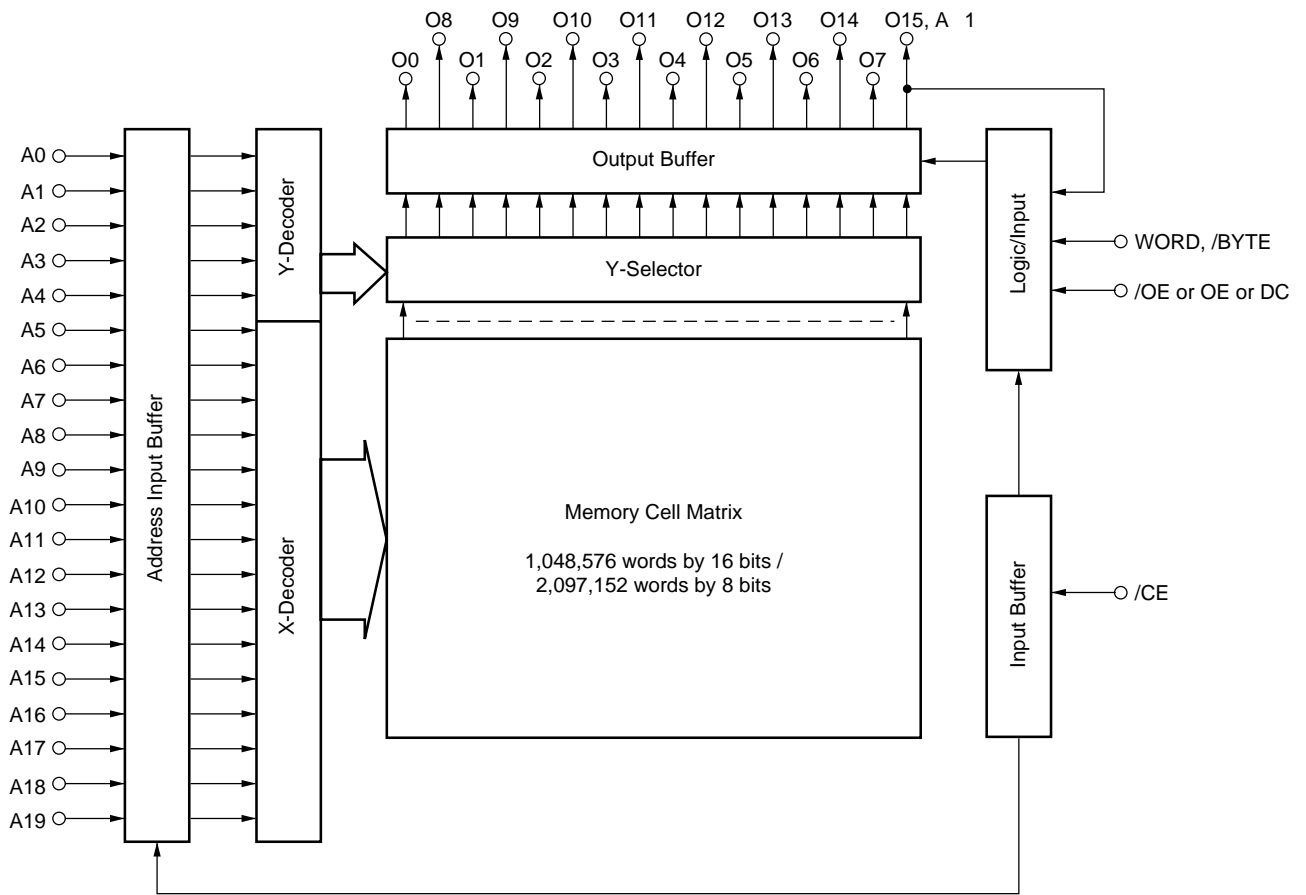

Mask Option

The active levels of output enable pin (/OE or OE or DC) are mask programmable and optional, and can be selected from among " 0 " " 1 " " x " shown in the table below.

Option	/OE or OE or DC	OE active level
0	/OE	L
1	OE	H
x	DC	Don't care

Operation modes for each option are shown in the tables below.

Operation mode (Option : 0)

/CE	/OE	Mode	Output state
L	L	Active	Data out
	H		High-Z
H	H or L	Standby	High-Z

Operation mode (Option : 1)

/CE	OE	Mode	Output state
L	L	Active	High-Z
	H		Data out
H	H or L	Standby	High-Z

Operation mode (Option : x)

/CE	DC	Mode	Output state
L	H or L	Active	Data out
H	H or L	Standby	High-Z

Remark L : Low level input

H : High level input

Electrical Specifications

Absolute Maximum Ratings

Parameter	Symbol	Condition	Rating	Unit
Supply voltage	V_{CC}		-0.3 to +4.6	V
Input voltage	V_I		-0.3 to $V_{CC}+0.3$	V
Output voltage	V_O		-0.3 to $V_{CC}+0.3$	V
Operating ambient temperature	T_A		-10 to +70	°C
Storage temperature	T_{stg}		-65 to +150	°C

Caution Exposing the device to stress above those listed in Absolute Maximum Ratings could cause permanent damage. The device is not meant to be operated under conditions outside the limits described in the operational section of this specification. Exposure to Absolute Maximum Rating conditions for extended periods may affect device reliability.

Capacitance ($T_A = 25\text{ °C}$)

Parameter	Symbol	Test condition	MIN.	TYP.	MAX.	Unit
Input capacitance	C_I	$f = 1\text{ MHz}$			10	pF
Output capacitance	C_O				12	pF

DC Characteristics ($T_A = -10\text{ to }+70\text{ °C}$, $V_{CC} = 2.7\text{ to }3.6\text{ V}$)

Parameter	Symbol	Test conditions	MIN.	TYP.	MAX.	Unit
High level input voltage	V_{IH}		2.0		$V_{CC} + 0.3$	V
Low level input voltage	V_{IL}	$V_{CC} = 3.0\text{ V} \pm 0.3\text{ V}$	-0.3		+0.5	V
		$V_{CC} = 3.3\text{ V} \pm 0.3\text{ V}$	-0.3		+0.8	V
High level output voltage	V_{OH}	$I_{OH} = -100\text{ }\mu\text{A}$	2.4			V
Low level output voltage	V_{OL}	$I_{OL} = 2.1\text{ mA}$			0.4	V
Input leakage current	I_{LI}	$V_I = 0\text{ V to }V_{CC}$	-10		+10	μA
Output leakage current	I_{LO}	$V_O = 0\text{ V to }V_{CC}$, Chip deselected	-10		+10	μA
Power supply current	I_{CC1}	$/CE = V_{IL}$ (Active mode), $I_O = 0\text{ mA}$			30	mA
Standby current	I_{CC3}	$/CE = V_{CC} - 0.2\text{ V}$ (Standby mode)			30	μA

AC Characteristics (TA = -10 to +70 °C, Vcc = 2.7 to 3.6 V)

Parameter	Symbol	Test condition	V _{CC} = 3.0 V ± 0.3 V			V _{CC} = 3.3 V ± 0.3 V			Unit
			MIN.	TYP.	MAX.	MIN.	TYP.	MAX.	
Address access time	t _{ACC}				90			85	ns
Address skew time	t _{SKEW}	Note			10			10	ns
Chip enable access time	t _{CE}				90			85	ns
Output enable access time	t _{OE}				25			25	ns
Output hold time	t _{OH}		0			0			ns
Output disable time	t _{DF}		0		25	0		25	ns
WORD, /BYTE access time	t _{WB}				90			85	ns

Note t_{SKEW} indicates the following three types of time depending on the condition.

- 1) When switching /CE from high level to low level, t_{SKEW} is the time from the /CE low level input point until the next address is determined.
- 2) When switching /CE from low level to high level, t_{SKEW} is the time from the address change start point to the /CE high level input point.
- 3) When /CE is fixed to low level, t_{SKEW} is the time from the address change start point until the next address is determined.

Since specs are defined for t_{SKEW} only when /CE is active, t_{SKEW} is not subject to limitations when /CE is switched from high level to low level following address determination, or when the address is changed after /CE is switched from low level to high level.

Remark t_{DF} is the time from inactivation of Chip Enable input (/CE) or Output Enable input (/OE or OE) to high impedance state output.

AC Test Conditions

Input waveform (Rise / Fall time ≤ 5 ns)

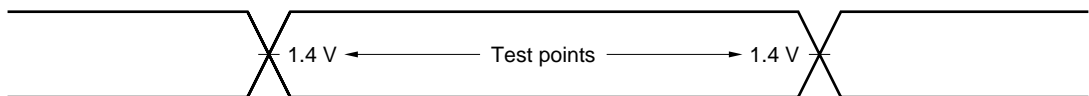

Output waveform

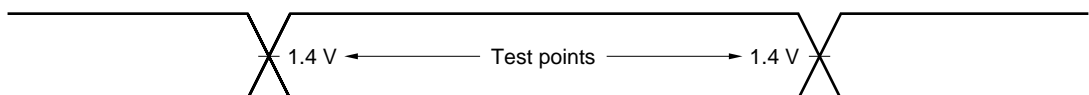

Output load

1TTL + 100 pF

Cautions on power application

To ensure normal operation, always apply power using /CE following the procedure shown below.

- 1) Input a high level to /CE during and after power application.
- 2) Hold the high level input to /CE for 200 ns or longer (wait time).
- 3) Start normal operation after the wait time has elapsed.

Power Application Timing Chart 1 (When /CE is made high at power application)

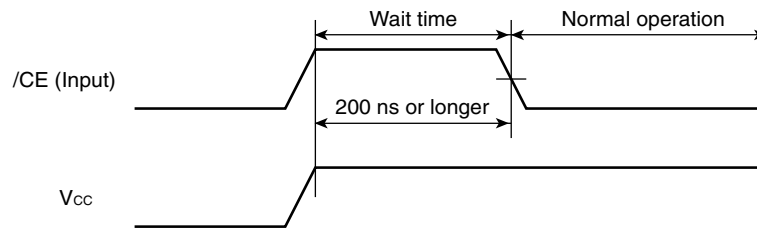

Power Application Timing Chart 2 (When /CE is made high after power application)

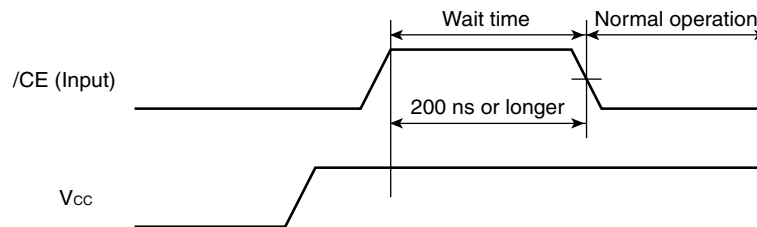

Caution Other signals can be either high or low during the wait time.

Read Cycle Timing Chart

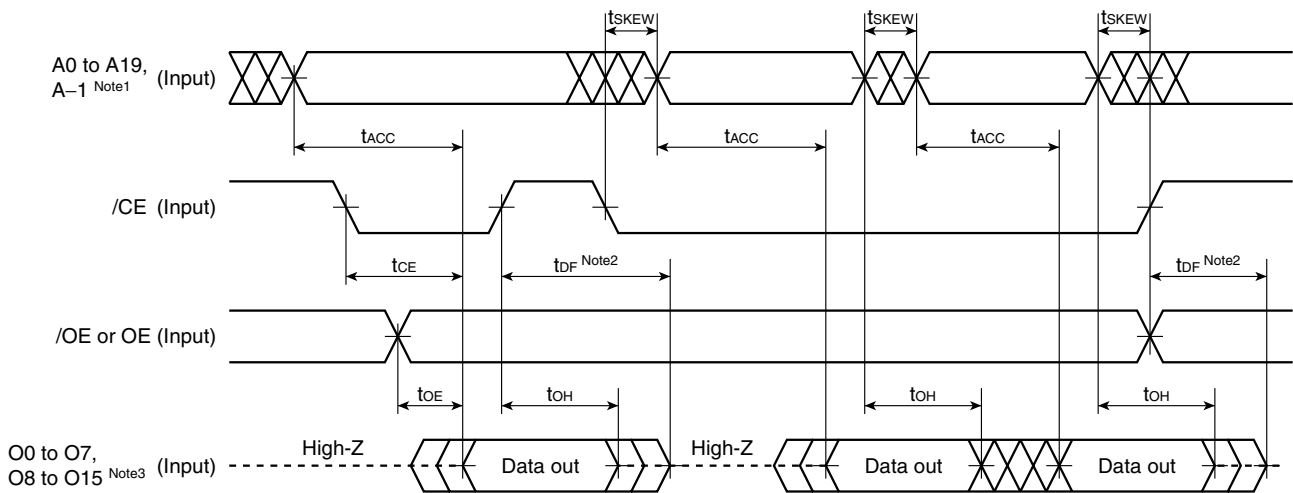

- Notes**
1. During WORD mode, A-1 is O15.
 2. t_{DF} is the time from inactivation of Chip Enable input (/CE) or Output Enable input (/OE or OE) to high impedance state output.
 3. During BYTE mode, O8 to O14 are high impedance and O15 is A-1.

WORD, /BYTE Switch Timing Chart

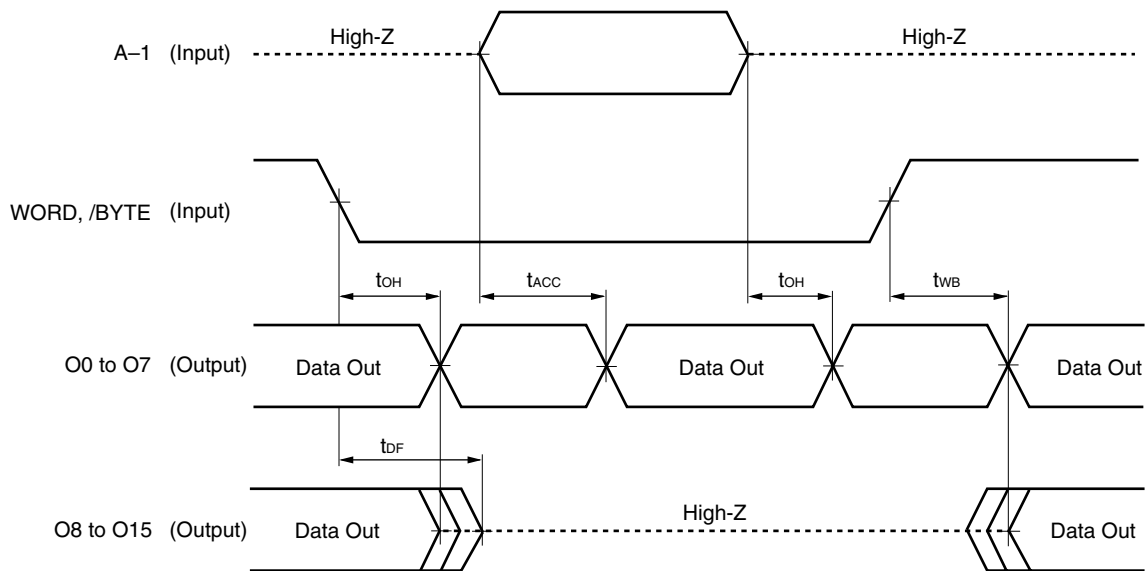

Remark Chip Enable (/CE) and Output Enable (/OE or OE) : Active.

Package Drawings

48-PIN PLASTIC TSOP (I) (12x20)

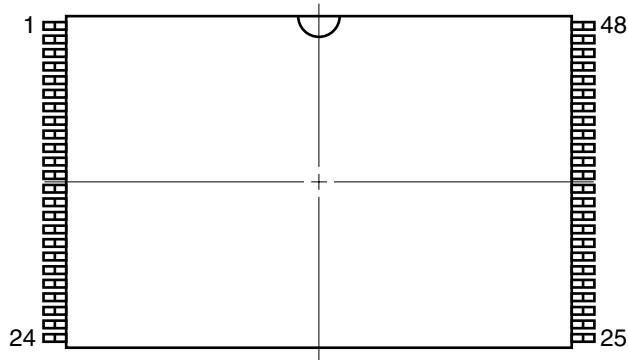

detail of lead end

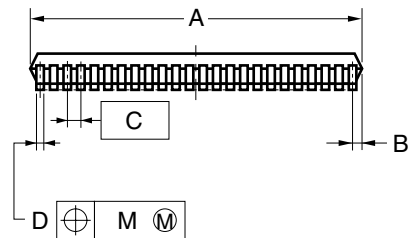
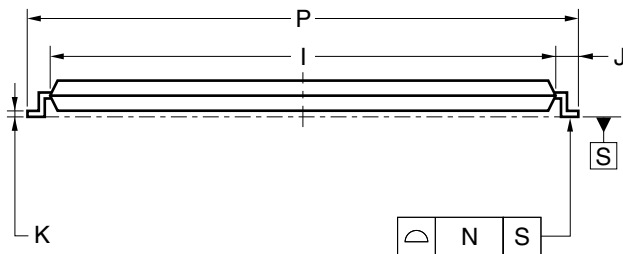
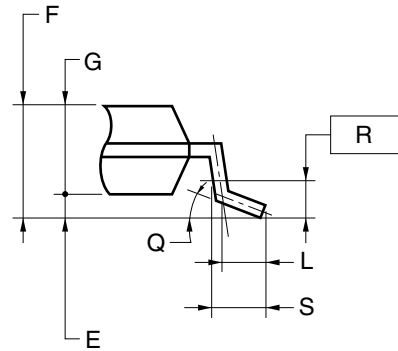

NOTES

- 1) Each lead centerline is located within 0.10 mm of its true position (T.P.) at maximum material condition.
- 2) "A" excludes mold flash. (Includes mold flash : 12.4 mm MAX.)

ITEM	MILLIMETERS
A	12.0±0.1
B	0.45 MAX.
C	0.5 (T.P.)
D	0.22±0.05
E	0.1±0.05
F	1.2 MAX.
G	1.0±0.05
I	18.4±0.1
J	0.8±0.2
K	0.145±0.05
L	0.5
M	0.10
N	0.10
P	20.0±0.2
Q	3° ^{+5°} _{-3°}
R	0.25
S	0.60±0.15

S48GZ-50-MJH-1

<R> 48-PIN PLASTIC FBGA (8x6)

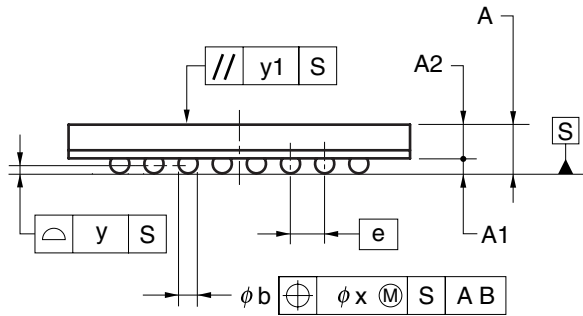
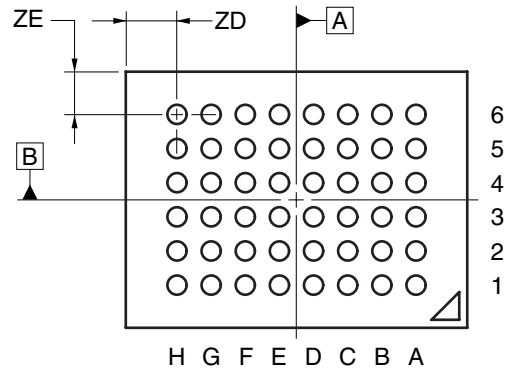
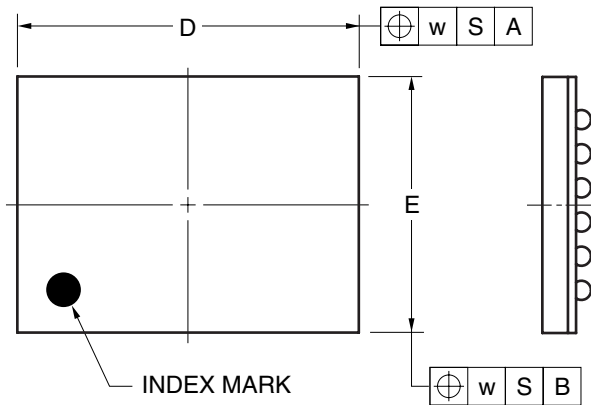

(UNIT:mm)

ITEM	DIMENSIONS
D	8.00±0.10
E	6.00±0.10
w	0.20
A	1.14±0.10
A1	0.35±0.05
A2	0.79
e	0.80
b	0.45±0.05
x	0.08
y	0.10
y1	0.20
ZD	1.20
ZE	1.00

P48F1-80-BC1

© NEC Electronics Corporation 2007

Recommended Soldering Conditions

Please consult with our sales offices for soldering conditions of the μ PD23C16300.

Types of Surface Mount Device

μ PD23C16300GZ-MJH : 48-pin PLASTIC TSOP(I) (12 x 20) (Normal bent)

μ PD23C16300GZ-MJH-A : 48-pin PLASTIC TSOP(I) (12 x 20) (Normal bent)

<R> μ PD23C16300F1-BC1-A : 48-pin PLASTIC FBGA (8 x 6)

Revision History

Edition/ Date	Page		Type of revision	Location	Description (Previous edition → This edition)
	This edition	Previous edition			
4th edition/ Sept. 2007	p.1	p.1	Modification	Ordering Information	48-pin TAPE FBGA (8 x 6) (F9-BC3) → 48-pin PLASTIC FBGA (8 x 6) (F1-BC1)
	p.3	p.3	Modification	Pin Configuration	
	p.12	p.12	Modification	Package Drawing	
	p.13	p.13	Modification	Types of Surface Mount Device	

NOTES FOR CMOS DEVICES

① VOLTAGE APPLICATION WAVEFORM AT INPUT PIN

Waveform distortion due to input noise or a reflected wave may cause malfunction. If the input of the CMOS device stays in the area between V_{IL} (MAX) and V_{IH} (MIN) due to noise, etc., the device may malfunction. Take care to prevent chattering noise from entering the device when the input level is fixed, and also in the transition period when the input level passes through the area between V_{IL} (MAX) and V_{IH} (MIN).

② HANDLING OF UNUSED INPUT PINS

Unconnected CMOS device inputs can be cause of malfunction. If an input pin is unconnected, it is possible that an internal input level may be generated due to noise, etc., causing malfunction. CMOS devices behave differently than Bipolar or NMOS devices. Input levels of CMOS devices must be fixed high or low by using pull-up or pull-down circuitry. Each unused pin should be connected to V_{DD} or GND via a resistor if there is a possibility that it will be an output pin. All handling related to unused pins must be judged separately for each device and according to related specifications governing the device.

③ PRECAUTION AGAINST ESD

A strong electric field, when exposed to a MOS device, can cause destruction of the gate oxide and ultimately degrade the device operation. Steps must be taken to stop generation of static electricity as much as possible, and quickly dissipate it when it has occurred. Environmental control must be adequate. When it is dry, a humidifier should be used. It is recommended to avoid using insulators that easily build up static electricity. Semiconductor devices must be stored and transported in an anti-static container, static shielding bag or conductive material. All test and measurement tools including work benches and floors should be grounded. The operator should be grounded using a wrist strap. Semiconductor devices must not be touched with bare hands. Similar precautions need to be taken for PW boards with mounted semiconductor devices.

④ STATUS BEFORE INITIALIZATION

Power-on does not necessarily define the initial status of a MOS device. Immediately after the power source is turned ON, devices with reset functions have not yet been initialized. Hence, power-on does not guarantee output pin levels, I/O settings or contents of registers. A device is not initialized until the reset signal is received. A reset operation must be executed immediately after power-on for devices with reset functions.

⑤ POWER ON/OFF SEQUENCE

In the case of a device that uses different power supplies for the internal operation and external interface, as a rule, switch on the external power supply after switching on the internal power supply. When switching the power supply off, as a rule, switch off the external power supply and then the internal power supply. Use of the reverse power on/off sequences may result in the application of an overvoltage to the internal elements of the device, causing malfunction and degradation of internal elements due to the passage of an abnormal current.

The correct power on/off sequence must be judged separately for each device and according to related specifications governing the device.

⑥ INPUT OF SIGNAL DURING POWER OFF STATE

Do not input signals or an I/O pull-up power supply while the device is not powered. The current injection that results from input of such a signal or I/O pull-up power supply may cause malfunction and the abnormal current that passes in the device at this time may cause degradation of internal elements. Input of signals during the power off state must be judged separately for each device and according to related specifications governing the device.

These commodities, technology or software, must be exported in accordance with the export administration regulations of the exporting country. Diversion contrary to the law of that country is prohibited.

- **The information in this document is current as of September, 2007. The information is subject to change without notice. For actual design-in, refer to the latest publications of NEC Electronics data sheets or data books, etc., for the most up-to-date specifications of NEC Electronics products. Not all products and/or types are available in every country. Please check with an NEC Electronics sales representative for availability and additional information.**

- No part of this document may be copied or reproduced in any form or by any means without the prior written consent of NEC Electronics. NEC Electronics assumes no responsibility for any errors that may appear in this document.
- NEC Electronics does not assume any liability for infringement of patents, copyrights or other intellectual property rights of third parties by or arising from the use of NEC Electronics products listed in this document or any other liability arising from the use of such products. No license, express, implied or otherwise, is granted under any patents, copyrights or other intellectual property rights of NEC Electronics or others.
- Descriptions of circuits, software and other related information in this document are provided for illustrative purposes in semiconductor product operation and application examples. The incorporation of these circuits, software and information in the design of a customer's equipment shall be done under the full responsibility of the customer. NEC Electronics assumes no responsibility for any losses incurred by customers or third parties arising from the use of these circuits, software and information.
- While NEC Electronics endeavors to enhance the quality, reliability and safety of NEC Electronics products, customers agree and acknowledge that the possibility of defects thereof cannot be eliminated entirely. To minimize risks of damage to property or injury (including death) to persons arising from defects in NEC Electronics products, customers must incorporate sufficient safety measures in their design, such as redundancy, fire-containment and anti-failure features.
- NEC Electronics products are classified into the following three quality grades: "Standard", "Special" and "Specific".

The "Specific" quality grade applies only to NEC Electronics products developed based on a customer-designated "quality assurance program" for a specific application. The recommended applications of an NEC Electronics product depend on its quality grade, as indicated below. Customers must check the quality grade of each NEC Electronics product before using it in a particular application.

"Standard": Computers, office equipment, communications equipment, test and measurement equipment, audio and visual equipment, home electronic appliances, machine tools, personal electronic equipment and industrial robots.

"Special": Transportation equipment (automobiles, trains, ships, etc.), traffic control systems, anti-disaster systems, anti-crime systems, safety equipment and medical equipment (not specifically designed for life support).

"Specific": Aircraft, aerospace equipment, submersible repeaters, nuclear reactor control systems, life support systems and medical equipment for life support, etc.

The quality grade of NEC Electronics products is "Standard" unless otherwise expressly specified in NEC Electronics data sheets or data books, etc. If customers wish to use NEC Electronics products in applications not intended by NEC Electronics, they must contact an NEC Electronics sales representative in advance to determine NEC Electronics' willingness to support a given application.

(Note)

- (1) "NEC Electronics" as used in this statement means NEC Electronics Corporation and also includes its majority-owned subsidiaries.
- (2) "NEC Electronics products" means any product developed or manufactured by or for NEC Electronics (as defined above).