

HIGH FREQUENCY, WITHOUT BUILT-IN CAPACITORS SMD WASHABLE CERAMIC RESONATORS AWSZT

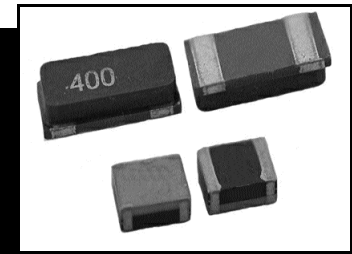

7434, 4741, 3731, 2520

FEATURES:

- Low resonant impedance.
- Excellent environmental resistance.
- Reflow capable.
- High stability washable type.
- Industrial grade.

APPLICATIONS:

- Remote controls.
- Electric appliances.
- Mobile phones, DVD, CD-Rom.
- Microprocessor clocks.
- Automotive controllers.
- Industrial controllers.

STANDARD SPECIFICATIONS

Abracon P/N	Freq. range (MHz)	Resonant Impedance Ω max.	Frequency tolerance	Frequency stability @-20°C to +80°C	Aging in 10 years	Operating temperature	Package Style*
AWSZT [] MGS MGD MGA	2.0~7.99	100 Ω for $2.0 < F < 3.0$ MHz 50 Ω for $3.0 \leq F < 3.5$ MHz 30 Ω for $3.5 \leq F \leq 7.99$ MHz	$\pm 0.5\%$	$\pm 0.3\%$	$\pm 0.3\%$	-20°C to +80°C -40°C to +85°C -40°C to +125°C	7434
AWSZT [] MTS MTD MTA	8.0~13.0	25 Ω	$\pm 0.5\%$	$\pm 0.3\%$	$\pm 0.3\%$	-20°C to +80°C -40°C to +85°C -40°C to +125°C	4741
AWSZT [] MVS MVD MVA	8.0~13.0	25 Ω	$\pm 0.5\%$	$\pm 0.3\%$	$\pm 0.3\%$	-20°C to +80°C -40°C to +85°C -40°C to +125°C	3731
AWSZT [] MXS MXD MXA	13.01~50.0	40 Ω	$\pm 0.5\%$	$\pm 0.3\%$	$\pm 0.3\%$	-20°C to +80°C -40°C to +85°C -40°C to +125°C	4741
AWSZT [] MCS MCD MCA	13.01~50.0	40 Ω	$\pm 0.5\%$	$\pm 0.3\%$	$\pm 0.3\%$	-20°C to +80°C -40°C to +85°C -40°C to +125°C	3731
AWSZT [] MSS MSD MSA	20.0~50.0	40 Ω For ≤ 32 MHz 50 Ω For ≤ 40 MHz 60 Ω For ≤ 50 MHz	$\pm 0.5\%$	$\pm 0.3\%$	$\pm 0.3\%$	-20°C to +80°C -40°C to +85°C -40°C to +125°C	2520

*Please see package options and dimensions on page 35A
Please check for availability on M[]D and M[]A Series
Frequency stability: M[]D: $\pm 0.5\%$ typ. -40°C to +85°C
M[]A: $\pm 0.7\%$ typ. -40°C to +125°C

Storage temperature: -40°C to +125°C

We perform IC characterization to match your application.

Please call us for details.

Packaging: Option Tape and Reel (1,000 pcs.) see appendix H.

Marking, see appendix G. Application notes, see appendix A.

Environmental and mechanical specification, see appendix C. Group 6.

Recommended handling, see appendix F.

ORDERING OPTIONS

AWSZTMXX - Packaging

G, T, V, X, C or S - T (Tape and reel)
S, D or A

Test Circuit:

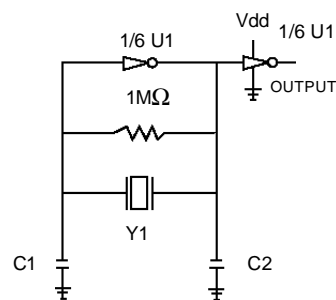

U1: CD4069UB
74HCU04 (>8MHz)
Y1: RESONATOR
C1 C2: 30pF $\pm 20\%$
:15pF $\pm 20\%$ (20M ~ 25.99M)
10pF $\pm 20\%$ (25M ~ 50M)

**ABRACON IS
ISO 9001 / QS 9000
CERTIFIED**

NOTE: Left blank if standard • All specifications and markings subject to change without notice

29 Journey • Aliso Viejo, CA 92656 • USA
(949) 448-7070 • FAX: (949) 448-8484

E-MAIL: abinfo@abracon.com • INTERNET ADDRESS: www.abracon.com

ABRACON
CORPORATION

36
Rev. B
01/2003

HIGH FREQUENCY, WITH OR WITHOUT BUILT-IN CAPACITORS
SURFACE MOUNT CERAMIC RESONATORS
ASZT, ASCR, AWSZT, AWSCR

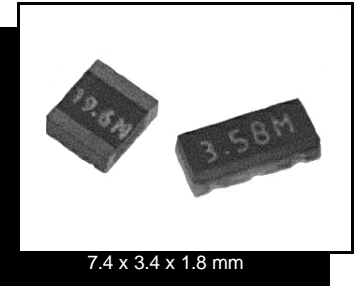

ASZT or AWSZT

ASCR or AWSCR

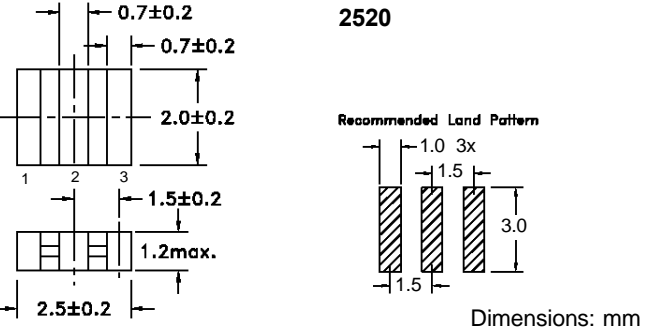
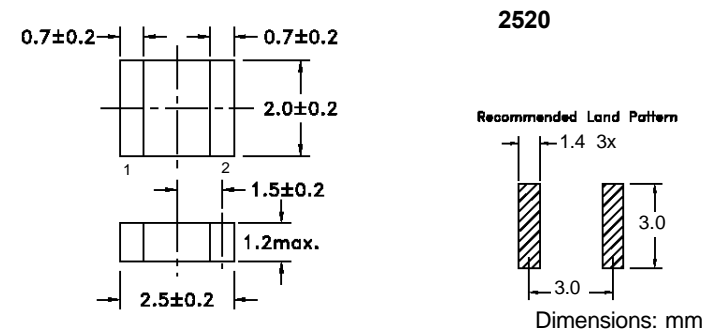
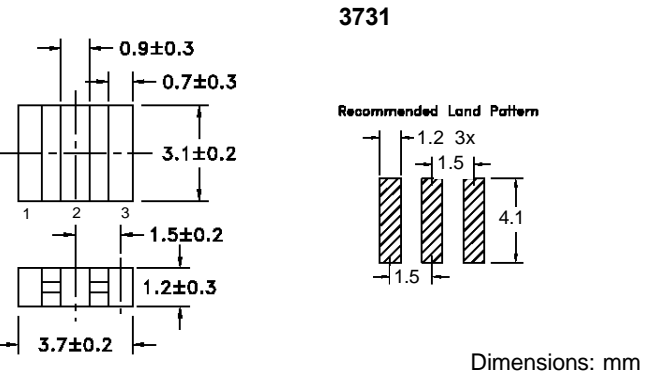
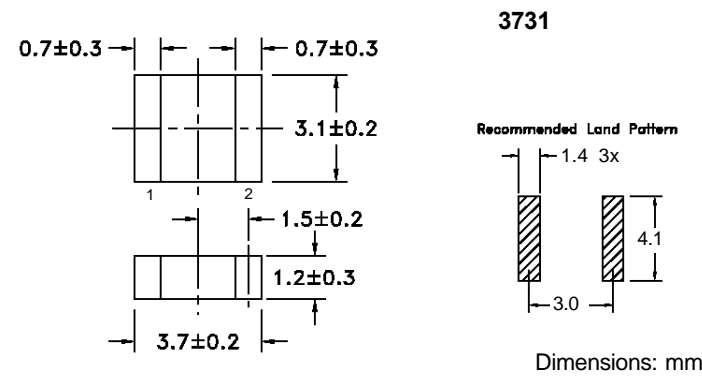
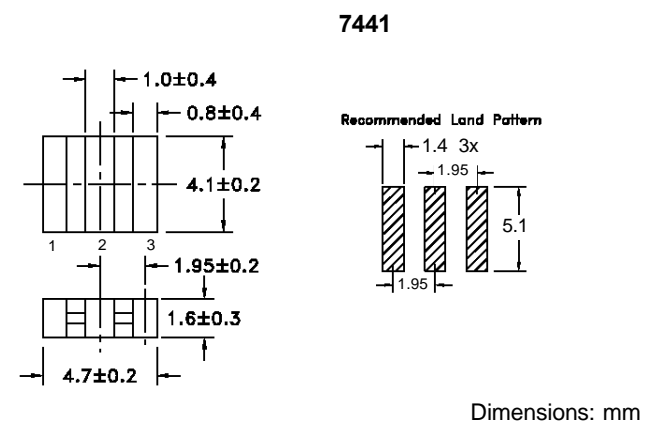
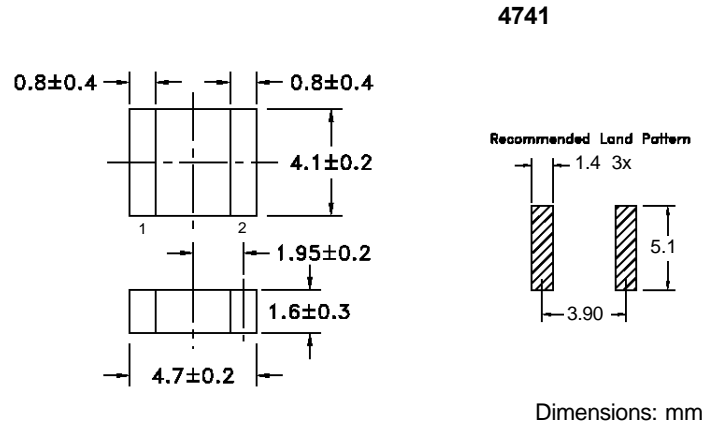
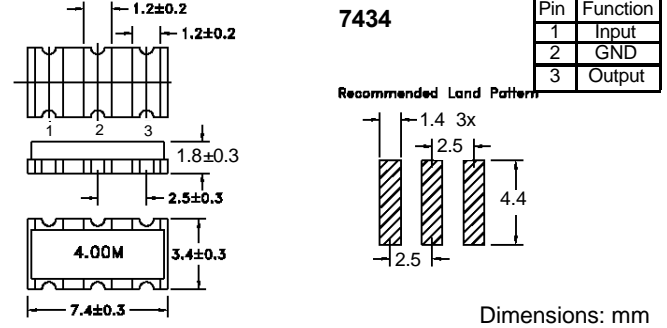
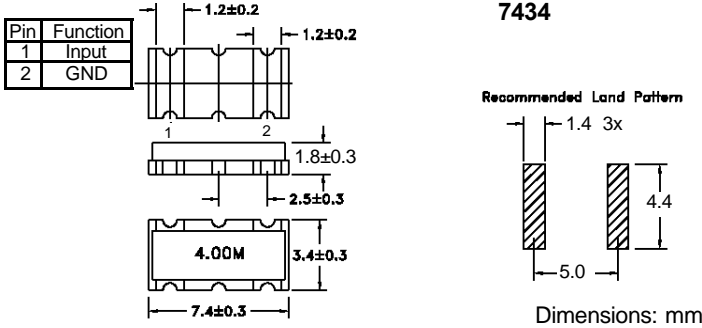

ABRACON IS
ISO 9001 / QS 9000
CERTIFIED

NOTE: Left blank if standard • All specifications and markings subject to change without notice

29 Journey • Aliso Viejo, CA 92656 • USA
(949) 448-7070 • FAX: (949) 448-8484

E-MAIL: abinfo@abracon.com • INTERNET ADDRESS: www.abracon.com



Washability Specification

**This product can be washed using the following solvents
under the suggested conditions:**

Solvents:
HCFC, Isopropyl Alcohol, Trichloroethane, Tap water, Demineralized Water, Pine Alpha ST-100S
Ultrasonic Wash:
Less than 1 min. (Frequency:28KHz,Ouput:20W/L) Immersion Wash or others: Less than 5 min.
Solvents temperature should be at 60°C or under 60°C
Drying:
By air blow at 80°C max.