

General Description

MIC2005/2015 is a current limiting, high-side power switch, designed for general purpose power distribution and control in digital televisions (DTV), printers, set top boxes (STB), PCs, PDAs, and other peripheral devices.

MIC2005/2015 primary functions are current limiting and power switching. It is thermally protected and will shutdown should its internal temperature reach unsafe levels, protecting both the device and the load, under high current or fault conditions.

Features include fault reporting, with fault blanking to eliminate noise-induced false alarms, output slew rate limiting, under voltage detection, automatic-on output, and enable pin with choice of either active low or active high enable. The FET is self-contained, with the current limit value being factory set to one of several convenient levels.

MIC2015 offers a unique new patented feature: Kickstart™, which allows momentary high current surges to pass unrestricted without sacrificing overall system safety.

MIC2005/2015 is an excellent choice for USB and IEEE 1394 (FireWire) applications or for any system where current limiting and power control are desired.

The MIC2005/2015 is offered in space saving 5-pin SOT-23, 6-pin SOT-23, and 2mm x 2mm MLF packages.

Data sheets and support documentation can be found on Micrel's web site at www.micrel.com.

Features

- 70mΩ typical on-resistance
- Enable active high or active low
- 2.5V - 5.5V operating range
- Pre-set current limit values of 0.5 A, 0.8 A, and 1.2 A
- Automatic-on output after fault
- Thermal Protection
- Under voltage lock-out (UVLO)
- Low quiescent current
- UL Certified

Applications

- Digital televisions (DTV)
- Set top boxes
- PDAs
- Printers
- USB / IEEE 1394 Power Distribution
- Desktop and Laptop PCs
- Game consoles
- Docking stations
- Chargers
- UL Certification Required

Typical Application

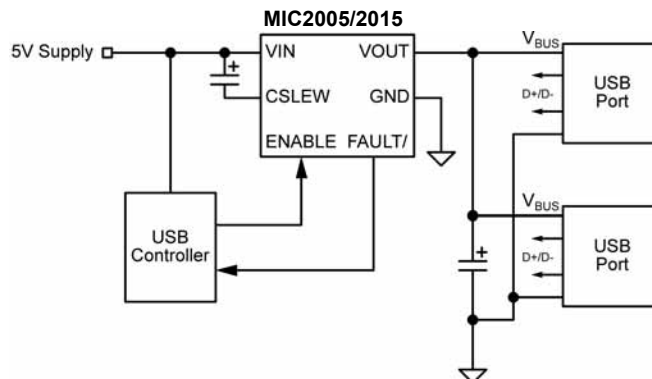

Figure 1. Typical Application Circuit



Kickstart™ is a trademark of Micrel, Inc
MLF and MicroLeadFrame are trademarks of Amkor Technology, Inc.

Protected by U.S. Patent No. 7,170,732
UL Certification No. E179633

Micrel Inc. • 2180 Fortune Drive • San Jose, CA 95131 • USA • tel +1 (408) 944-0800 • fax + 1 (408) 474-1000 • <http://www.micrel.com>

MIC2005/2015 Pin Functions

Part Number		I Limit ⁴	Pin Function					
Normal Limiting	Kickstart		I Adj.	Enable	C _{SLEW}	FAULT/	DLM ³	Load Discharge
2003	2013	Fixed	--	--	--	--	--	--
2004	2014		--	▲	--	--	--	▲
2005 ¹	2015		--	▲	▲	▲	--	--
2005 ²	X		--	▲		▲	--	--
2006	2016		--	▲	▲	--	▲	--
2007	2017		Adj.	▲	▲	▲	--	--
2008	2018	▲		▲	▲	--	--	--
2009	2019	▲		▲	--	▲	--	--

- Notes:**
1. C_{SLEW} available on 5-Pin SOT-23-5
 2. C_{SLEW} not available on 5-Pin SOT-23-5
 3. Dynamic Load Management
 4. Adj = Adjustable current limit Fixed = Factory programmed current limit

Ordering Information

Part Number	Marking ²	Current Limit	Kickstart	Package	
MIC2005-0.5YM5	<u>F</u> 05F	0.5 A	No	SOT-23-5	
MIC2005-0.8YM5	<u>F</u> 08F	0.8 A			
MIC2005-1.2YM5	<u>F</u> 12F	1.2 A			
MIC2005-0.5YM6	<u>FF</u> 05	0.5 A		No	SOT-23-6
MIC2005-0.8YM6	<u>FF</u> 08	0.8 A			
MIC2005-1.2YM6	<u>FF</u> 12	1.2 A			
MIC2005-0.5YML	<u>E</u> 05	0.5 A			2 mmX2 mm MLF
MIC2005-0.8YML	<u>E</u> 08	0.8 A			
MIC2005-1.2YML	<u>E</u> 12	1.2 A			
MIC2015-0.5YM6	<u>FN</u> 05	0.5 A	Yes	SOT-23-6	
MIC2015-0.8YM6	<u>FN</u> 08	0.8 A			
MIC2015-1.2YM6	<u>FN</u> 12	1.2 A			
MIC2015-0.5YML	<u>N</u> 05	0.5 A		2 mmX2 mm MLF	
MIC2015-0.8YML	<u>N</u> 09	0.8 A			
MIC2015-1.2YML	<u>N</u> 12	1.2 A			

- Notes:**
1. All MIC2005/2015 parts are lead free.
 2. Under-bar symbol () may not be to scale

Pin Configuration

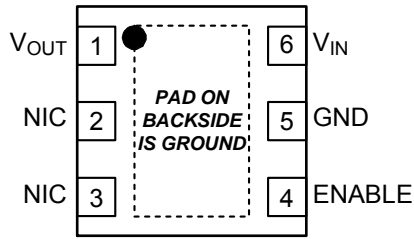

6-Lead 2 mm X 2 mm MLF (ML)
Top View

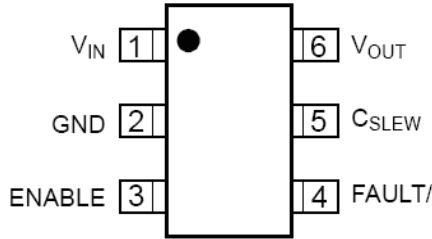

SOT 23-6 (M6)
Top View

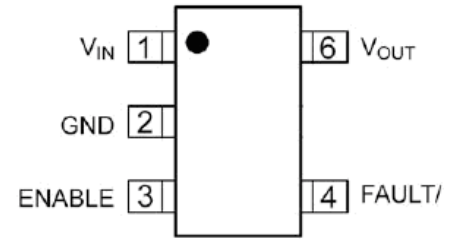

SOT 23-5 (M5)
Top View

Pin Description

Pin Number			Pin Name	Type	Description
SOT-23		MLF			
5-Pin	6-Pin				
1	1	6	VIN	Input	Supply input. This pin provides power to both the output switch and the MIC2005/2015's internal control circuitry.
2	2	5	GND	--	Ground.
3	3	4	ENABLE	Input	Switch Enable (Input): Active-high (-1) or active-low (-2)
4	4	3	FAULT/	Output	Fault status. A logic LOW on this pin indicates the MIC2005/2015 is in current limiting, or has been shut down by the thermal protection circuit. This is an 'Open Drain' output allowing logical OR'ing of multiple MIC2005/2015s.
	5	2	CLSEW	Input	Slew rate control. Adding a small value capacitor between this pin and VIN slows turn-ON of the power FET.
6	6	1	VOUT	Output	Switch output. The load being driven by MIC2005/2015 is connected to this pin.

Absolute Maximum Ratings⁽¹⁾

V_{IN}, V_{OUT}.....-0.3 to 6V
 All other pins.....-0.3 to 5.5V
 Power Dissipation..... Internally Limited
 Continuous Output Current..... 2.25A
 Maximum Junction Temperature..... 150°C
 Storage Temperature -65°C to 150°C

Operating Ratings⁽²⁾

Supply Voltage..... 2.5V to 5.5V
 Continuous Output Current Range 0 to 2.1A
 Ambient Temperature Range -40°C to 85°C
 Package Thermal Resistance (θ_{JA})
 SOT-23-5/6 230°C/W
 MLF 2x2 mm..... 90°C/W
 MLF 2x2 mm θ_{JC}⁽⁵⁾ 45°C/W

Electrical Characteristics

V_{IN} = 5V, T_{AMBIENT} = 25°C unless specified otherwise. **Bold** indicates -40°C to +85°C limits.

Symbol	Parameter	Conditions	Min	Typ	Max	Units
V _{IN}	Switch Input Voltage		2.5		5.5	V
I _{IN}	Internal Supply Current	Switch = OFF, ENABLE = 0V		1	5	μA
I _{IN}	Internal Supply Current	Switch = ON, I _{OUT} = 0 ENABLE = 1.5V		80	300	μA
I _{LEAK}	Output Leakage Current	V _{IN} = 5V, V _{OUT} = 0 V, ENABLE = 0		12	100	μA
R _{DS(ON)}	Power Switch Resistance	V _{IN} = 5V, I _{OUT} = 100 mA		70	100	mΩ
					125	mΩ
I _{LIMIT}	Current Limit: -0.5	V _{OUT} = 0.8V _{IN} to V _{OUT} = 1V	0.5	0.7	0.9	A
I _{LIMIT}	Current Limit: -0.8	V _{OUT} = 0.8V _{IN} to V _{OUT} = 1V	0.8	1.1	1.5	A
I _{LIMIT}	Current Limit: -1.2	V _{OUT} = 0.8V _{IN} , to V _{OUT} = 1V	1.2	1.6	2.1	A
I _{LIMIT_2nd}	Secondary current limit (Kickstart)	MIC2015, V _{IN} = 2.7V	2.2	4	6	A
UVLO _{THRESHOLD} _D	Under Voltage Lock Out Threshold	V _{IN} Rising	2.0	2.25	25	V
		V _{IN} Falling	1.9	2.15	2.4	V
V _{EN}	ENABLE Input Voltage	V _{IL(max.)}			0.5	V
		V _{IH(min)}	1.5			V
I _{EN}	ENABLE Input Current	V _{EN} = 0V to 5.0V		1	5	μA
V _{FAULT}	Fault status Output Voltage	I _{OL} = 10mA		0.25	0.4	V
OT _{THRESHOLD}	Over-temperature Threshold	T _J increasing		145		°C
		T _J decreasing		135		

AC Characteristics

Symbol	Parameter	Condition	Min	Typ	Max	Units
t_{RISE}	Output Turn-ON rise time	$R_L = 10\Omega$, $C_{LOAD} = 1\mu F$, $V_{OUT} = 10\%$ to 90%	500	1000	1500	μs
t_{D_FAULT}	Delay before asserting or releasing FAULT/	Time from current limiting to FAULT/ state change. MIC2005	20	32	49	ms
		Time from I_{OUT} continuously exceeding primary current limit condition to FAULT/ state change. MIC2015	77	128	192	ms
t_{D_LIMIT}	Delay before current limiting	MIC2015	77	128	192	ms
t_{RESET}	Delay before resetting Kickstart current limit delay, t_{LIMIT}	Out of current limit following a current limit. MIC2015	77	128	192	ms
t_{ON_DLY}	Output Turn-ON Delay	$R_L = 43\Omega$, $C_L = 120\mu F$, $V_{EN} = 50\%$ to $V_{OUT} = 90\%$		1000	1500	μs
t_{OFF_DLY}	Output Turn-OFF Delay	$R_L = 43\Omega$, $C_L = 120\mu F$, $V_{EN} = 50\%$ to $V_{OUT} = 90\%$			700	μs

ESD

Symbol	Parameter	Condition	Min	Typ	Max	Units
V_{ESD_HB}	Electro Static Discharge Voltage: Human Body Model	V_{OUT} and GND	± 4			kV
		All other pins	± 2			kV
ESD_MCHN	Electro Static Discharge Voltage; Machine Model	All pins Machine Model	± 200			V

Notes:

1. Exceeding the absolute maximum rating may damage the device.
2. The device is not guaranteed to function outside its operating rating.
3. Devices are ESD sensitive. Handling precautions recommended. Human body model, 1.5k in series with 100pF.
4. Specification for packaged product only.
5. Requires proper thermal mounting to achieve this performance.

Timing Diagrams

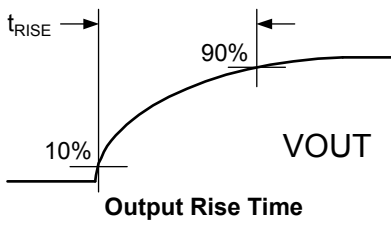
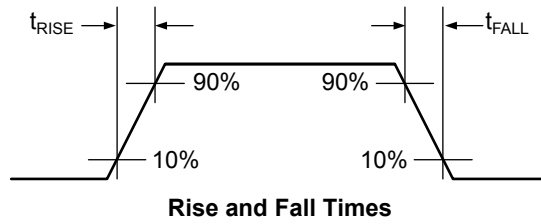
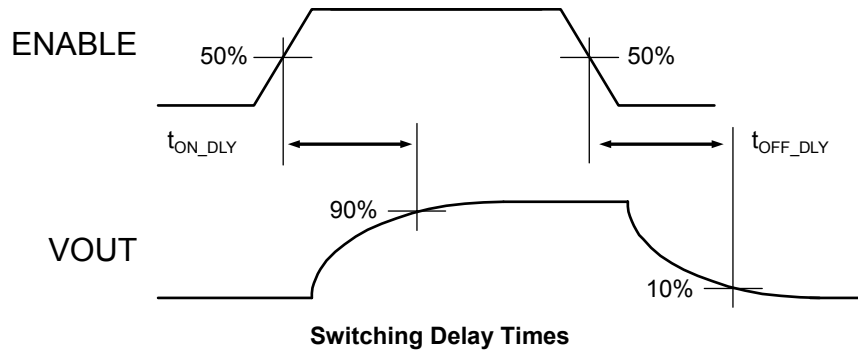

Typical Characteristics

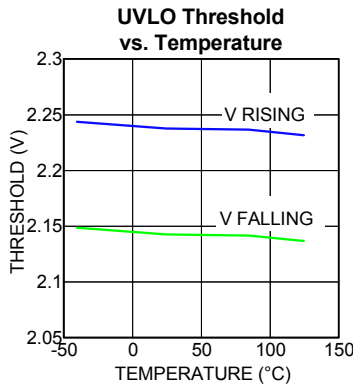
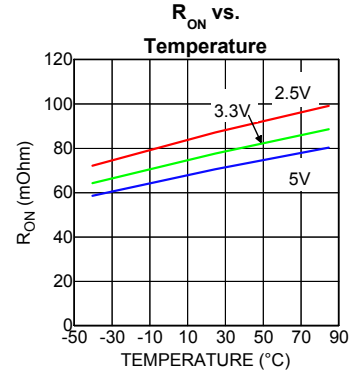
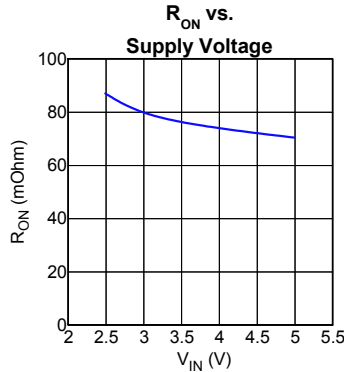
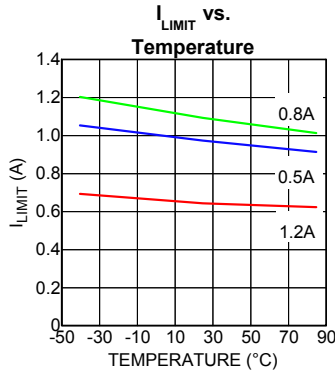
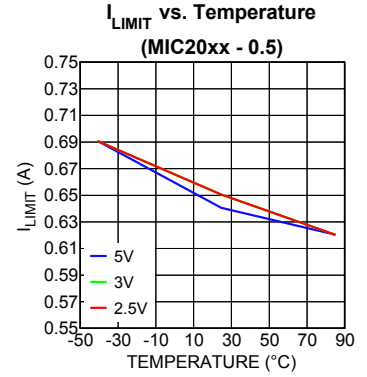
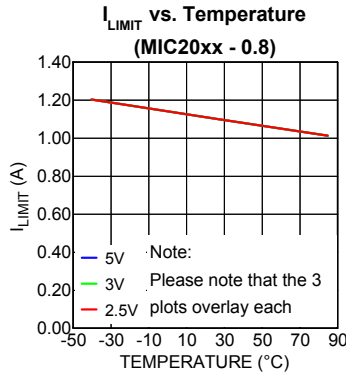
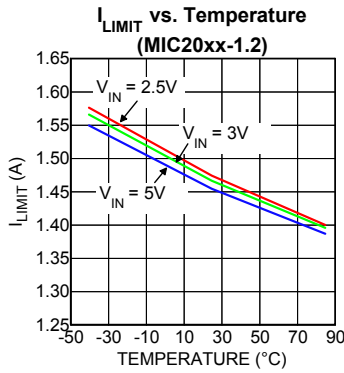
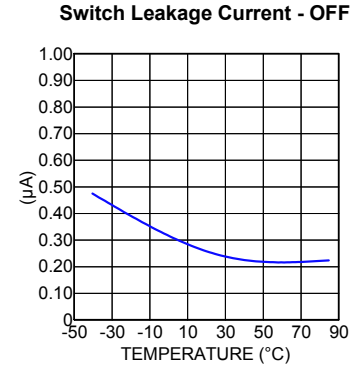
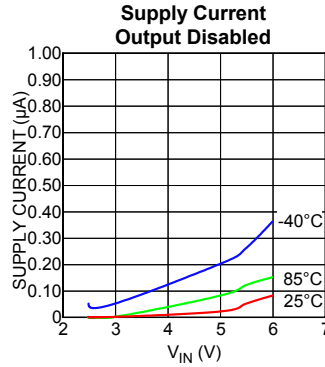
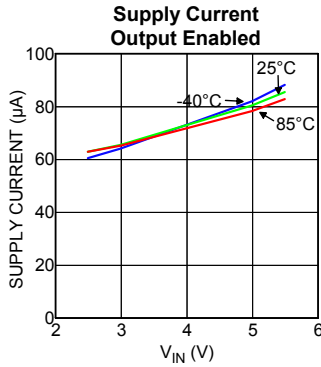

Functional Characteristics

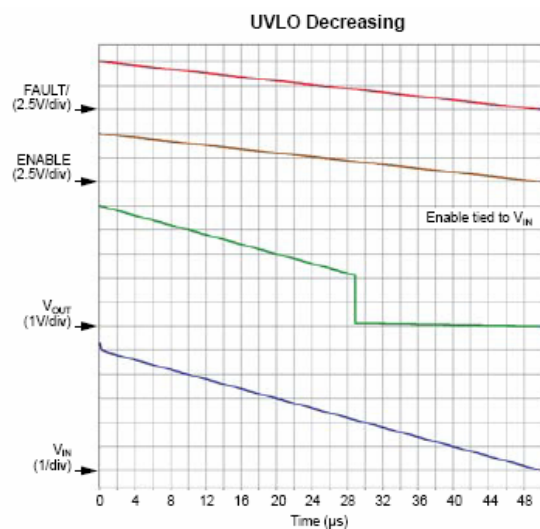
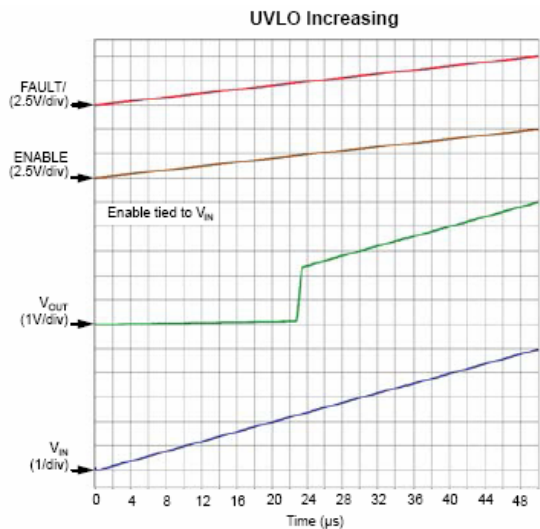
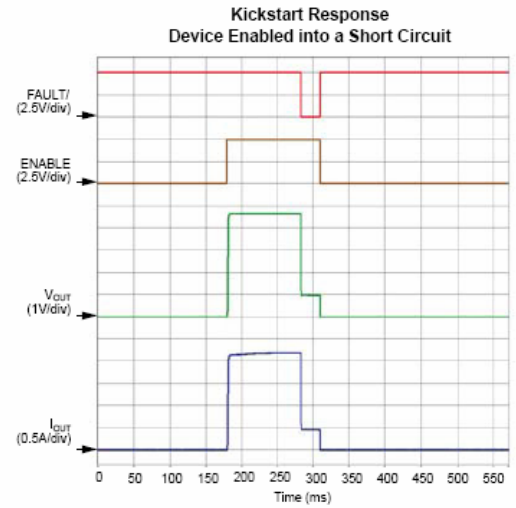
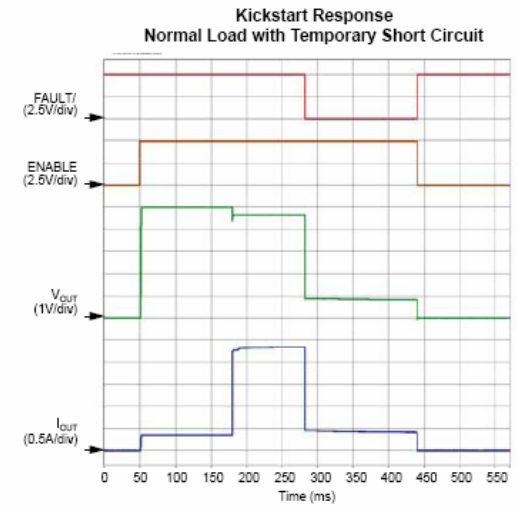
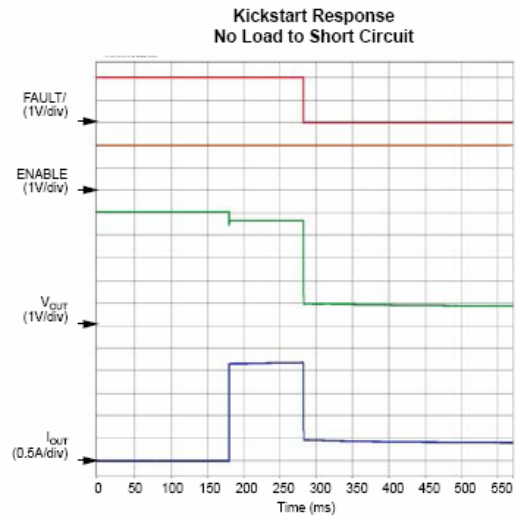
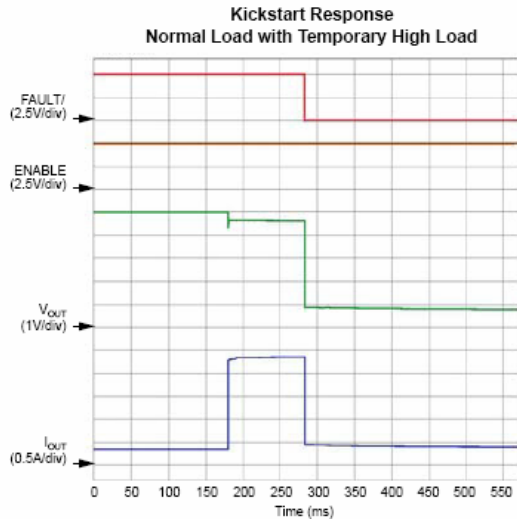

Inrush Current Response
MIC20xx-0.5

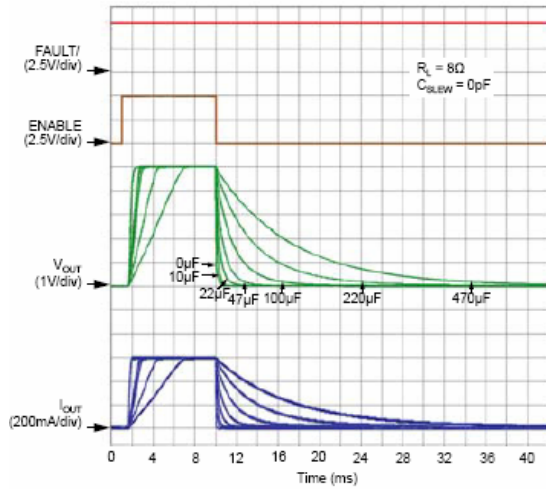

Turn-On/Turn-Off

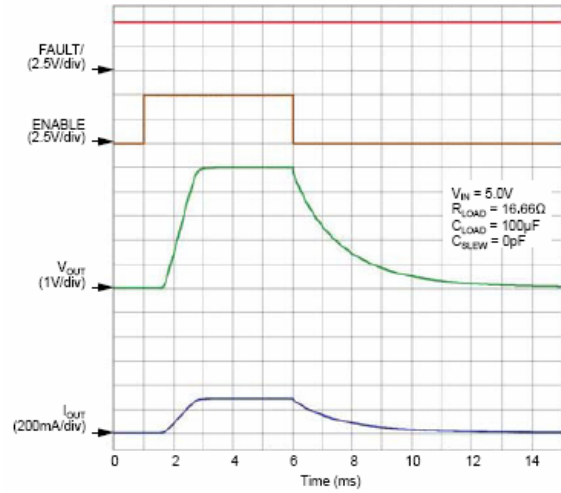

Current Limit Response Thermal Shutdown

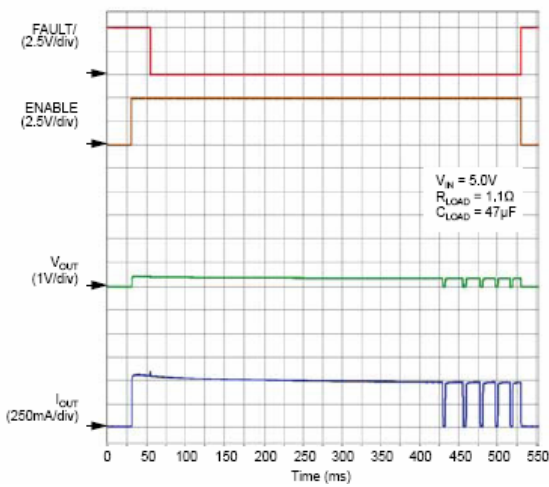

Functional Diagram

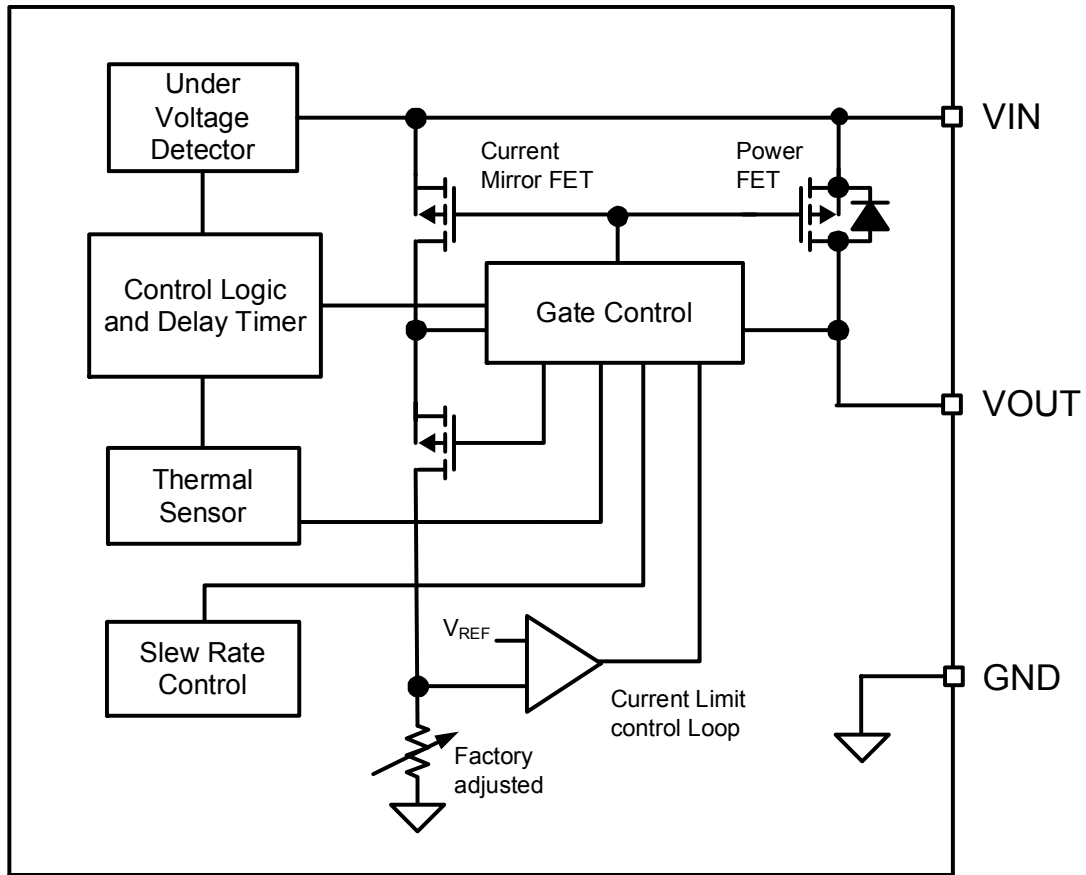

Figure 2 MIC2005/2015 Block Diagram

Functional Description

V_{IN} and V_{OUT}

V_{IN} is both the power supply connection for the internal circuitry driving the switch and the input (Source connection) of the power MOSFET switch. V_{OUT} is the Drain connection of the power MOSFET and supplies power to the load. In a typical circuit, current flows from V_{IN} to V_{OUT} toward the load. Since the switch is bi-directional when enabled, if V_{OUT} is greater than V_{IN}, current will flow from V_{OUT} to V_{IN}.

When the switch is disabled, current will not flow to the load, except for a small unavoidable leakage current of a few microamps. However, should V_{OUT} exceed V_{IN} by more than a diode drop (~0.6V), while the switch is disabled, current will flow from output to input via the power MOSFET's body diode. This effect can be used to advantage when large bypass capacitors are placed on MIC2005/2015's output. When power to the switch is removed, the output capacitor will be automatically discharged.

If discharging C_{LOAD} is required by your application, consider using MIC2005/2015 or MIC2007/2017 in place of MIC2005/2015. These MIC2000 family members are equipped with a discharge FET to insure complete discharge of C_{LOAD}.

Current Sensing and Limiting

MIC2005/2015 protects the system power supply and load from damage by continuously monitoring current through the on-chip power MOSFET. Load current is monitored by means of a current mirror in parallel with the power MOSFET switch. Current limiting is invoked when the load exceeds an internally set over-current threshold. When current limiting is activated the output current is constrained to the limit value, and remains at this level until either the load/fault is removed, the load's current requirement drops below the limiting value, or the MIC2005/2015 goes into thermal shutdown.

Kickstart (MIC2015 only)

The MIC2015 is designed to allow momentary current surges (Kickstart) before the onset of current limiting, which permits dynamic loads, such as small disk drives or portable printers to draw the energy needed to overcome inertial loads without sacrificing system safety. In this respect, the MIC2015 differs markedly from MIC2005 and its peers, which immediately limit load current, potentially starving the motor and causing the appliance to stall or stutter.

During this delay period, typically 128 ms, a secondary current limit is in effect. If the load demands a current in excess the secondary limit, MIC2015 acts immediately to restrict output current to the secondary limit for the

duration of the Kickstart period. After this time the MIC2015 reverts to its normal current limit. An example of Kickstart operation is shown below.

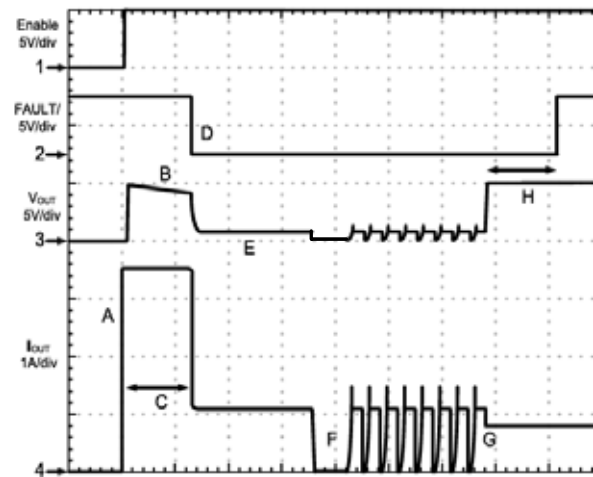

Figure 3. Kickstart Operation

Picture Key:

- A) MIC2015 is enabled into an excessive load (slew rate limiting not visible at this time scale) The initial current surge is limited by either the overall circuit resistance and power supply compliance, or the secondary current limit, whichever is less.
- B) R_{ON} of the power FET increases due to internal heating (effect exaggerated for emphasis).
- C) Kickstart period.
- D) Current limiting initiated. FAULT/ goes LOW.
- E) V_{OUT} is non-zero (load is heavy, but not a dead short where V_{OUT} = 0. Limiting response will be the same for dead shorts).
- F) Thermal shutdown followed by thermal cycling.
- G) Excessive load released, normal load remains. MIC2015 drops out of current limiting.
- H) FAULT/ delay period followed by FAULT/ going HIGH.

Under Voltage Lock Out

Under voltage lock-out insures no anomalous operation occurs before the device's minimum input voltage of 2.5V had been achieved. Prior to reaching this voltage, the output switch (power MOSFET) is OFF and no circuit functions, such as FAULT/ or ENABLE, are considered to be valid or operative.

ENABLE

ENABLE is a HIGH or LOW true control signal, which activates the main MOSFET switch. ENABLE has two voltage ranges depending on whether the switch is an active high or active low device.. ENABLE can be wire-OR'd with other MIC2005/2015s or similar devices without damage to the device. ENABLE may be driven higher than VIN, but no higher than 5.5V.

FAULT/

FAULT/ is an N-channel 'open drain' output, which is asserted (LOW true) when MIC2005/2015's either begins current limiting or enters thermal shutdown.

In MIC2005/2015, FAULT/ asserts after a brief delay period, usually 32 ms. This delay ensures that FAULT/ is asserted only upon valid, enduring, over-current conditions and that transitory event error reports are filtered out.

After a fault clears, FAULT/ remains asserted for the delay period; 32ms for the MIC2005/2015.

Because FAULT/ is an 'open drain' it must be pulled HIGH with an external resistor output and it may be wire-OR'd with other similar outputs, sharing a single pull-up resistor. FAULT/ may be tied to a pull-up voltage source which is higher than VIN, but no greater than 5.5V.

Slew Rate Control (Not present with SOT23-5 (M5))

Large capacitive loads can create significant current surges when charged through a high-side switch such as the MIC2005/2015. For this reason, MIC2005/2015 provides built-in slew rate control to limit the initial inrush currents upon enabling the power MOSFET switch. Slew rate control is active upon powering up, and upon re-enabling the load. At shutdown, the discharge slew rate is controlled by the external load and output capacitor.

Thermal Shutdown

Thermal shutdown is employed to protect MIC2005/2015 from damage should the die temperature exceed safe operating levels. Thermal shutdown shuts off the output MOSFET if the die temperature reaches 145°C.

MIC2005/2015 will automatically resume operation when the die temperature cools down to 135°C. If resumed operation results in reheating of the die, another shutdown cycle will occur and the MIC2005/2015 will continue cycling between ON and OFF states until the offending load has been removed. Depending on PCB layout, package type, ambient temperature, etc., hundreds of milliseconds may elapse from the incidence of a fault to the output MOSFET being shut off. This delay is due to thermal time constants within the system itself. In no event will the device be damaged due to thermal overload because die temperature is monitored continuously by on-chip circuitry.

Application Information

I_{LIMIT} vs. I_{OUT} measured

MIC2005/2015's current limiting circuitry is designed to act as a constant current source to the load. As the load tries to pull more than the allotted current, V_{OUT} drops and the input to output voltage differential increases. When $V_{IN} - V_{OUT}$ exceeds 1V, I_{OUT} drops below I_{LIMIT} to reduce the drain of fault current on the system's power supply and to limit internal heating of MIC2005/2015.

When measuring I_{OUT} it is important to bear this voltage dependence in mind, otherwise the measurement data may appear to indicate a problem when none really exists. This voltage dependence is illustrated in Figures 4 and 5.

In Figure 4 output current is measured as V_{OUT} is pulled below V_{IN} , with the test terminating when V_{OUT} is 1V below V_{IN} . Observe that once I_{LIMIT} is reached I_{OUT} remains constant throughout the remainder of the test. In Figure 5 this test is repeated but with $V_{IN} - V_{OUT}$ exceeding 1V.

When $V_{IN} - V_{OUT} > 1V$, MIC2005/2015's current limiting circuitry responds by decreasing I_{OUT} , as can be seen in Figure 5. In this demonstration, V_{OUT} is being controlled and I_{OUT} is the measured quantity. In real life applications V_{OUT} is determined in accordance with Ohm's law by the load and the limiting current.

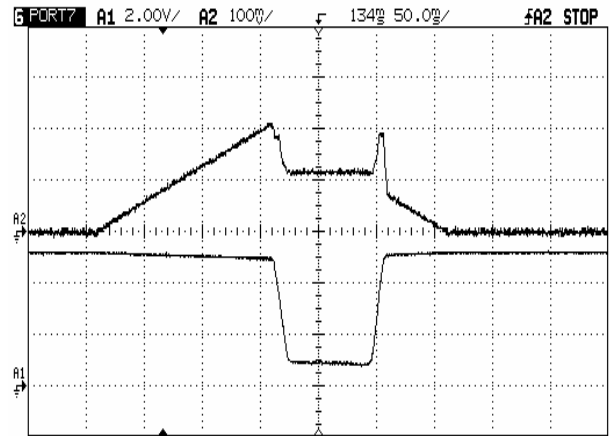

2009B SOT 502 #1 - Current ramp (5V)
 Radj=249ohms, Rfault=499ohms
 A1: Vout (2V/div)
 A2: Iout (500mA/div)

Figure 5. I_{OUT} in Current Limiting for $V_{OUT} > 1V$

This folding back of I_{LIMIT} can be generalized by plotting I_{LIMIT} as a function of V_{OUT} , as shown below. The slope of V_{OUT} between $I_{OUT} = 0$ and $I_{OUT} = I_{LIMIT}$ (where $I_{LIMIT} = 1$) is determined by R_{ON} of MIC2005/2015 and I_{LIMIT} .

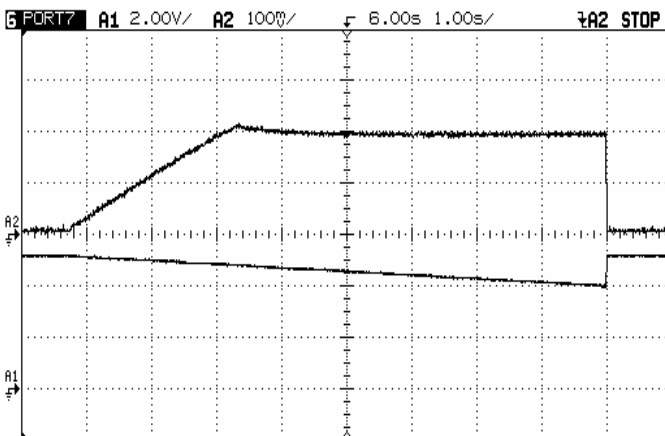

2009B SOT 502 #1 - Vout ramp 5V to 4V (5V)
 Radj=249ohms, Rfault=499ohms
 A1: Vout (2V/div)
 A2: Iout (500mA/div)

Figure 4. I_{OUT} in Current Limiting for $V_{OUT} \leq 1V$

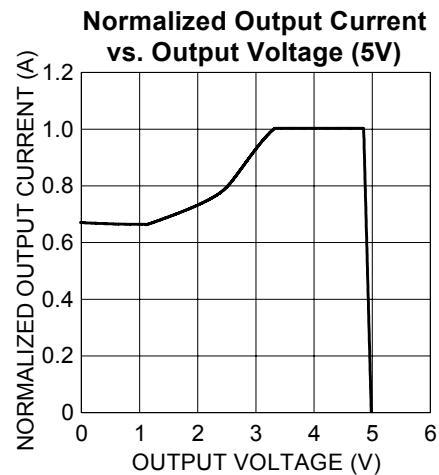

Figure 6.

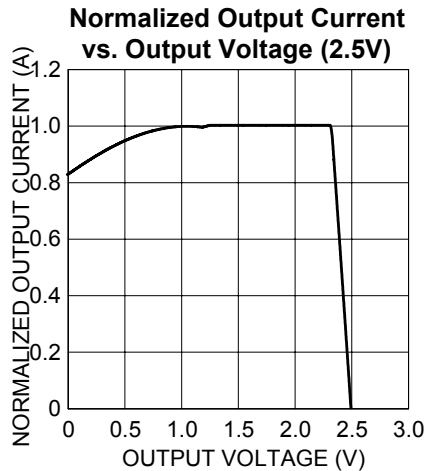

Figure 7.

C_{SLEW} (Not present with SOT23-5 (M5))

The C_{SLEW} input is provided to increase control of the output voltage ramp at turn-on. This input allows designers the option of decreasing the output's slew rate (slowing the voltage rise) by adding an external capacitance between the pin, C_{SLEW}, and VIN. This capacitance slows the rate at which the pass FET gate voltage increases and thus, slows both the response to an Enable command as well as V_{OUT}'s ascent to its final value.

Figure 8 illustrates effect of C_{SLEW} on turn-ON delay and output rise time.

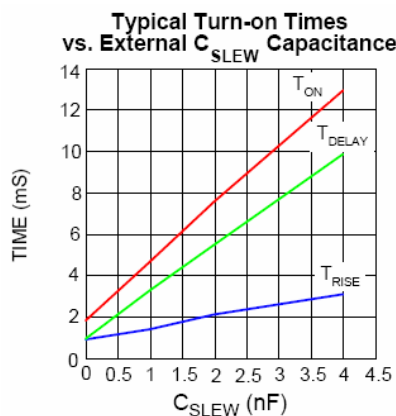

Figure 8

C_{SLEW}'s effect on I_{LIMIT}

An unavoidable consequence of adding C_{SLEW} capacitance is a reduction in the MIC2005/2015's ability to quickly limit current transients or surges. A sufficiently large capacitance can prevent both the primary and secondary current limits from acting in time to prevent damage to the MIC2005/2015 or the system from a

short circuit fault. For this reason, the upper limit on the value of C_{SLEW} is 4nF.

Kickstart (MIC2015)

Kickstart allows brief current surges to pass to the load before the onset of normal current limiting, which permits dynamic loads to draw bursts of energy without sacrificing system safety.

Functionally, Kickstart is a forced override of the normal current limiting function provided by MIC2015. The Kickstart period is governed by an internal timer which allows current to pass unimpeded to the load for 128ms and then normal (primary) current limiting goes into action.

During Kickstart a secondary current limiting circuit is monitoring output current to prevent damage to the MIC2015, as a hard short combined with a robust power supply can result in currents of many tens of amperes. This secondary current limit is nominally set at 4 Amps and reacts immediately and independently of the Kickstart period. Once the Kickstart timer has finished its count the primary current limiting circuit takes over and holds I_{OUT} to its programmed limit for as long as the excessive load persists.

Once MIC2015 drops out of current limiting the Kickstart timer initiates a lock-out period of 128ms such that no further bursts of current above the primary current limit, will be allowed until the lock-out period has expired.

Kickstart may be over-ridden by the thermal protection circuit and if sufficient internal heating occurs, Kickstart will be terminated and I_{OUT} → 0. Upon cooling, if the load is still present I_{OUT} → I_{LIMIT}, not I_{KICKSTART}.

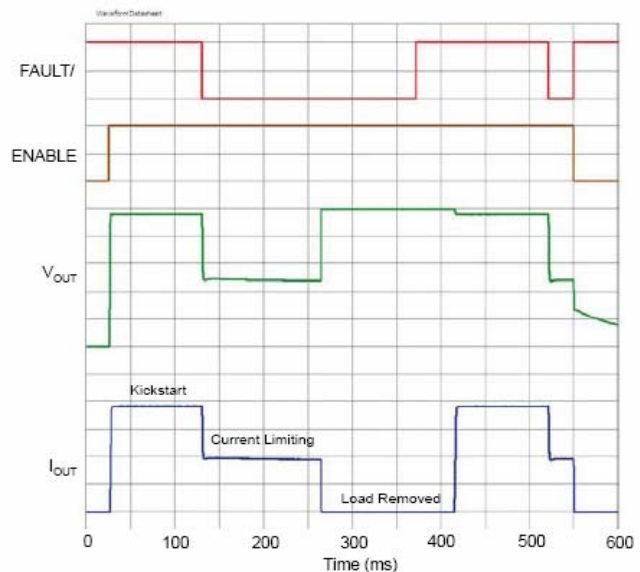

Figure 9. Kickstart

Supply Filtering

A 0.1µF to 1µF bypass capacitor positioned close to the V_{IN} and GND pins of MIC2005/2015 is both good design practice and required for proper operation of MIC2005/2015. This will control supply transients and ringing. Without a bypass capacitor, large current surges or an output short may cause sufficient ringing on V_{IN} (from supply lead inductance) to cause erratic operation of MIC2005/2015's control circuitry. Good quality, low ESR capacitors, such as Panasonic's TE or ECJ series, are suggested.

When bypassing with capacitors of 10µF and up, it is good practice to place a smaller value capacitor in parallel with the larger to handle the high frequency components of any line transients. Values in the range of 0.01µF to 0.1µF are recommended. Again, good quality, low ESR capacitors should be chosen.

Power Dissipation

Power dissipation depends on several factors such as the load, PCB layout, ambient temperature, and supply voltage. Calculation of power dissipation can be accomplished by the following equation:

$$P_D = R_{DS(ON)} \times (I_{OUT})^2$$

To relate this to junction temperature, the following equation can be used:

$$T_J = P_D \times R_{\theta(J-A)} + T_A$$

Where: T_J = junction temperature,

T_A = ambient temperature

R_{θ(J-A)} is the thermal resistance of the package

In normal operation MIC2005/2015's Ron is low enough that no significant I²R heating occurs. Device heating is most often caused by a short circuit, or very heavy load, when a significant portion of the input supply voltage appears across MIC2005/2015's power MOSFET. Under these conditions the heat generated will exceed the package and PCB's ability to cool the device and thermal limiting will be invoked.

In Figure 10 die temperature is plotted against I_{OUT} assuming a constant case temperature of 85°C. The

plots also assume a worst case R_{ON} of 140 mΩ at a die temperature of 135°C. Under these conditions it is clear that an SOT-23 packaged device will be on the verge of thermal shutdown, typically 140°C die temperature, when operating at a load current of 1.25A. For this reason we recommend using MLF packaged MIC2005/2015s for any design intending to supply continuous currents of 1A or more.

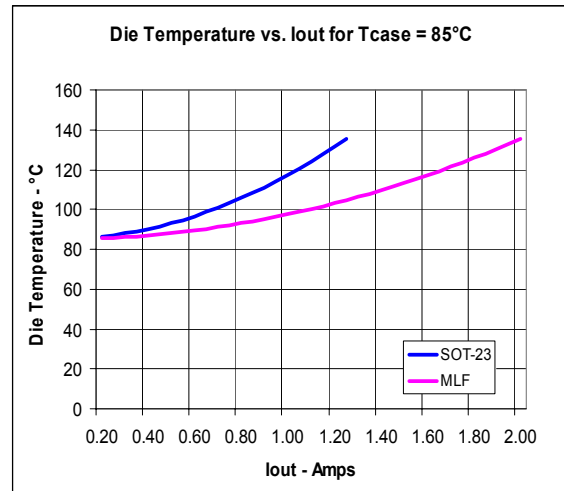

Figure 10. Die Temperature vs. I_{OUT}

Figure 10 assumes no backside contact is made to the thermal pad provided on the MLF package. For optimal performance at higher current levels, or in higher temperature environments, thermal contact with the PCB and the exposed power paddle on the back side of the MLF package should be made. This significantly reduces the package's thermal resistance thereby extending the MIC2005/2015's operating range. It should be noted that this backside paddle is electrically active and is connected to the MIC2005/2015's GND pin.

Package Information

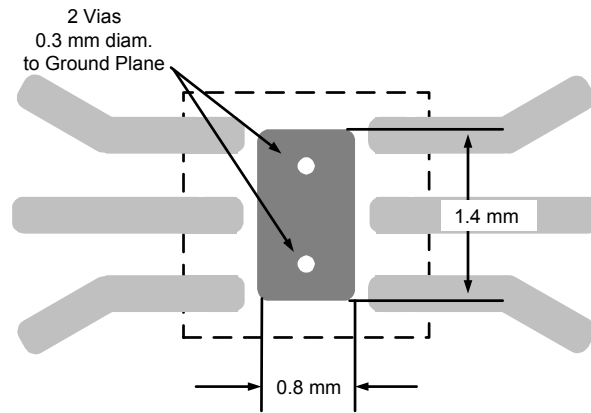
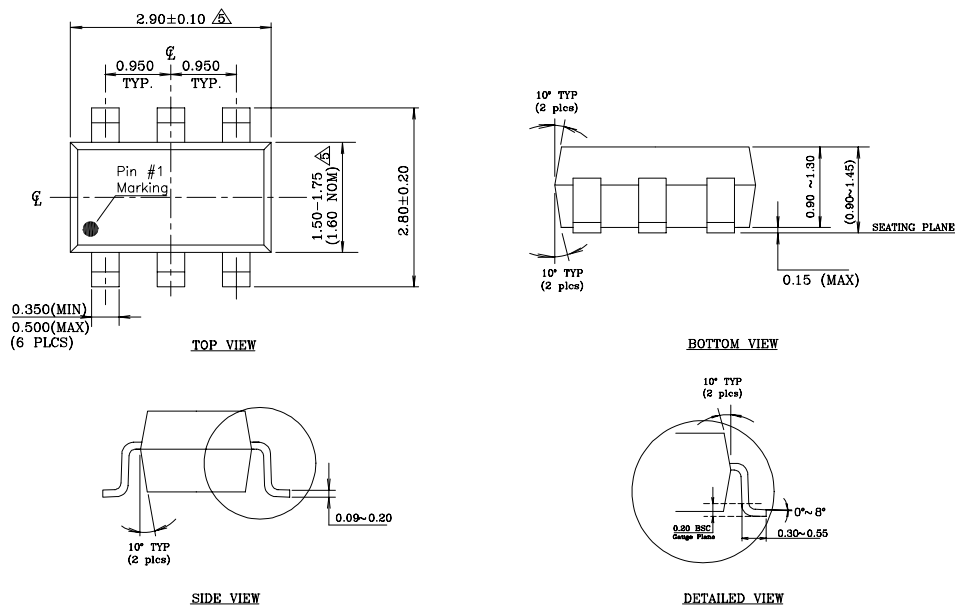

Figure 11. Pad for thermal mounting to PCB



NOTE:

1. Dimensions and tolerances are as per ANSI Y14.5M, 1982.
 2. Package surface to be mirror finish.
 3. Die is facing up for mold. Die is facing down for trim/form. ie. reverse trim/form.
 4. The footlength measuring is based on the gauge plane method.
- ⚠ Dimension are exclusive of mold flash & gate burr.

6-Pin SOT-23 (M6)

Package Information (Cont.)

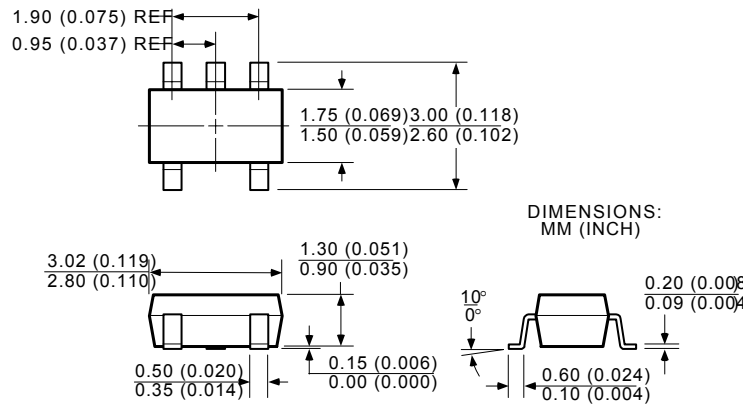

5-Pin SOT-23 (M5)

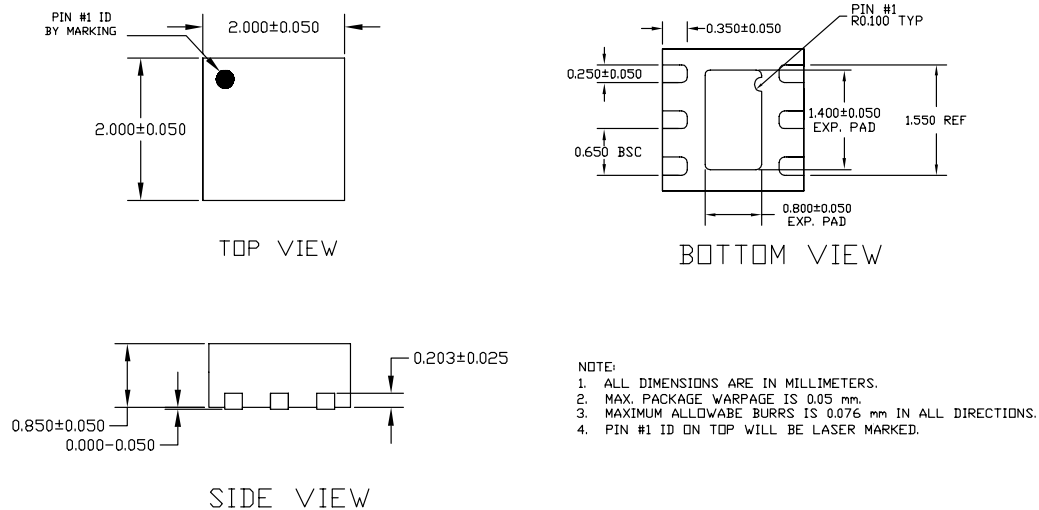

6 Pin 2mm x 2mm MLF (ML)

MICREL, INC. 2180 FORTUNE DRIVE SAN JOSE, CA 95131 USA
TEL +1 (408) 944-0800 FAX +1 (408) 474-1000 WEB <http://www.micrel.com>

The information furnished by Micrel in this data sheet is believed to be accurate and reliable. However, no responsibility is assumed by Micrel for its use. Micrel reserves the right to change circuitry and specifications at any time without notification to the customer.

Micrel Products are not designed or authorized for use as components in life support appliances, devices or systems where malfunction of a product can reasonably be expected to result in personal injury. Life support devices or systems are devices or systems that (a) are intended for surgical implant into the body or (b) support or sustain life, and whose failure to perform can be reasonably expected to result in a significant injury to the user. A Purchaser's use or sale of Micrel Products for use in life support appliances, devices or systems is a Purchaser's own risk and Purchaser agrees to fully indemnify Micrel for any damages resulting from such use or sale.

© 2004 Micrel, Incorporated.