

FEATURES

Excellent Hold Mode Distortion into 250 Ω

- 88 dB @ 30 MSPS (2.3 MHz V_{IN})
- 83 dB @ 30 MSPS (12.1 MHz V_{IN})
- 74 dB @ 30 MSPS (19.7 MHz V_{IN})

16 ns Acquisition Time to 0.01%

<1 ps Aperture Jitter

250 MHz Tracking Bandwidth

83 dB Feedthrough Rejection @ 20 MHz

3.3 nV/ $\sqrt{\text{Hz}}$ Spectral Noise Density

MIL-STD-Compliant Versions Available

APPLICATIONS

- A/D Conversion
- Direct IF Sampling
- Imaging/FLIR/Systems
- Peak Detectors
- Radar/EW/ECM
- Spectrum Analysis
- CCD ATE

FUNCTIONAL BLOCK DIAGRAM

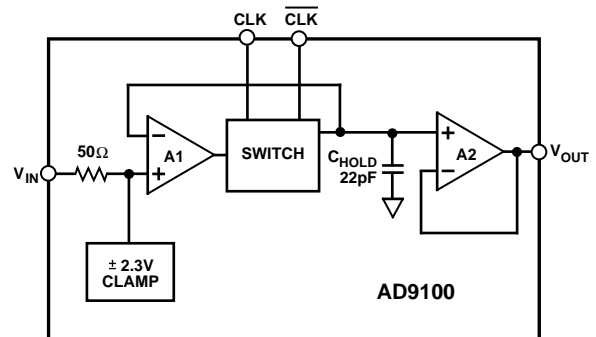

The AD9100 is "user friendly" and easy to apply: (1) it requires +5 V/-5.2 V power supplies; (2) the hold capacitor and switch power supply decoupling capacitors are built into the DIP package; (3) the encode clock is differential ECL to minimize clock jitter; (4) the input resistance is typically 800 $\text{k}\Omega$; (5) the analog input is internally clamped to prevent damage from voltage transients.

The AD9100 is available in a 20-lead side-braced "skinny DIP" package and a 28-lead LCC package. Commercial, industrial, and military temperature grade parts are available. Consult the factory for information about the availability of 883-qualified devices.

GENERAL DESCRIPTION

The AD9100 is a monolithic track-and-hold amplifier which sets a new standard for high speed and high dynamic range applications. It is fabricated in a mature high speed complementary bipolar process. In addition to innovative design topologies, a custom package is utilized to minimize parasitics and optimize dynamic performance.

Acquisition time (hold to track) is 13 ns to 0.1% accuracy, and 16 ns to 0.01%. The AD9100 boasts superlative hold-mode frequency domain performance; when sampling at 30 MSPS hold mode distortion is less than 83 dBfs for analog frequencies up to 12 MHz; and -74 dBfs at 20 MHz. The AD9100 can also drive capacitive loads up to 100 pF with little degradation in acquisition time; it is therefore well suited to drive 8- and 10-bit flash converters at clock speeds to 50 MSPS. With a spectral noise density of 3.3 nV/ $\sqrt{\text{Hz}}$ and feedthrough rejection of 83 dB at 20 MHz, the AD9100 is well suited to enhance the dynamic range of many 8- to 16-bit systems.

*Patent pending.

PRODUCT HIGHLIGHTS

1. Hold Mode Distortion is guaranteed.
2. Monolithic construction.
3. Analog input is internally clamped to protect against overvoltage transients and ensure fast recovery.
4. Output is short circuit protected.
5. Drives capacitive loads to 100 pF.
6. Differential ECL clock inputs.

REV. A

Information furnished by Analog Devices is believed to be accurate and reliable. However, no responsibility is assumed by Analog Devices for its use, nor for any infringements of patents or other rights of third parties which may result from its use. No license is granted by implication or otherwise under any patent or patent rights of Analog Devices.

AD9100–SPECIFICATIONS

ABSOLUTE MAXIMUM RATINGS¹

Supply Voltages ($\pm V_S$)	± 6 V
Continuous Output Current	70 mA
Analog Input Voltage ²	± 5 V
Operating Temperature Range (Case)	
AD9100JD	0°C to +70°C

AD9100AD/AE	-25°C to +85°C
AD9100SD/SE	-55°C to +125°C
Junction Temperature	+175°C
Storage Temperature	-65°C to +150°C
Lead Soldering Temperature (10 sec)	+300°C

ELECTRICAL CHARACTERISTICS (unless otherwise noted, $+V_S = +5$ V; $-V_S = -5.2$ V; $R_{LOAD} = 100 \Omega$; $R_{IN} = 50 \Omega$)

Parameter	Conditions	Temp	Test Level	AD9100AE/SE/JD/AD/SD ³			Units
				Min	Typ	Max	
DC ACCURACY							
Gain	$\Delta V_{IN} = 2$ V	Full	VI	0.989	0.994		V/V
Offset	$V_{IN} = 0$ V	Full	VI	-5	± 1	+5	mV
Output Resistance		25°C	V		0.4		Ω
Output Drive Capability		Full	VI	± 40	± 60		mA
PSRR	$\Delta V_S = 0.5$ V p-p	Full	VI	48	55		dB
Pedestal Sensitivity to Supply	$\Delta V_S = 0.5$ V p-p	Full	VI		0.9	3	mV/V
ANALOG INPUT/OUTPUT							
Output Voltage Range		Full	VI	+2	± 2.2	-2	V
Input Bias Current		25°C	VI	-8	± 3	+8	μ A
		Full	VI	-16		+16	μ A
Input Overdrive Current ⁴	$V_{IN} = \pm 4$ V; $R_{IN} = 50 \Omega$	25°C	V		± 22		mA
Input Capacitance		25°C	V		1/2		pF
Input Resistance		25°C, T_{MAX}	VI	350	800		k Ω
		T_{MIN}	VI	200			k Ω
CLOCK/CLOCK INPUTS							
Input Bias Current	$CL/\overline{CL} = -1.0$ V	Full	VI		4	5	mA
Input Low Voltage (V_{IL})		Full	VI	-1.8		-1.5	V
Input High Voltage (V_{IH})		Full	VI	-1.0		-0.8	V
TRACK MODE DYNAMICS							
Bandwidth (-3 dB)	$V_{OUT} \leq 0.4$ V p-p	Full	IV	150	250		MHz
Slew Rate	4 V Step	25°C	IV	550	850		V/ μ s
	4 V Step	Full	IV	500			V/ μ s
Overdrive Recovery Time ⁴ (to 0.1%)	$V_{IN} = \pm 4$ V to 0 V	25°C	V		21		ns
2nd Harm. Dist. (20 MHz, 2 V p-p)		Full	V		-65		dBc
3rd Harm. Dist. (20 MHz, 2 V p-p)		Full	V		-75		dBc
Integrated Output Noise (1-200 MHz)		25°C	V		45		μ V
RMS Spectral Noise @ 10 MHz		25°C	V		3.3		nV/ $\sqrt{\text{Hz}}$
HOLD MODE DYNAMICS							
Worst Harmonic (2.3 MHz, 30 MSPS)	$V_{OUT} = 2$ V p-p	25°C	V		-83		dBfs
Worst Harmonic (12.1 MHz, 30 MSPS)	$V_{OUT} = 2$ V p-p	25°C	IV		-80	-72	dBfs
Worst Harmonic (12.1 MHz, 30 MSPS)	$V_{OUT} = 2$ V p-p	T_{MAX}	IV			-70	dBfs
Worst Harmonic (12.1 MHz, 30 MSPS)	$V_{OUT} = 2$ V p-p	T_{MIN}	IV		-77	-68	dBfs
Worst Harmonic (19.7 MHz, 30 MSPS)	$V_{OUT} = 2$ V p-p	25°C	V		-74		dBfs
Hold Noise ⁵		25°C	V		$300 \times t_H$		V/s rms
Droop Rate ⁶	$V_{IN} = 0$ V	25°C	VI	1	6		\pm mV/ μ s
		T_{MIN}	VI	7	40		\pm mV/ μ s
		T_{MAX}	VI	5	30		\pm mV/ μ s
Feedthrough Rejection (20 MHz)	$V_{IN} = 2$ V p-p	Full	V		83		dB
TRACK-TO-HOLD SWITCHING							
Aperture Delay		25°C	V		+800		ps
Aperture Jitter		25°C	V		<1		ps
Pedestal Offset	$V_{IN} = 0$ V	25°C	VI	-5	± 1	+5	mV
		Full	VI	-10		+10	mV
Transient Amplitude	$V_{IN} = 0$ V	Full	V		± 6		mV
Settling Time to 1 mV		Full	IV		7	10	ns
Glitch Product	$V_{IN} = 0$ V	25°C	V		15		pV-s

Parameter	Conditions	Temp	Test Level	AD9100AE/SE/JD/AD/SD ³			Units
				Min	Typ	Max	
HOLD-TO-TRACK SWITCHING							
Acquisition Time to 0.1%	2 V Step	25°C	V		13		ns
Acquisition Time to 0.01%	2 V Step	Full	IV		16	23	ns
Acquisition Time to 0.01%	4 V Step	25°C	V		20		ns
POWER SUPPLY							
Power Dissipation		Full	VI		1.05	1.25	W
+V _S Current		Full	VI		96	118	mA
-V _S Current		Full	VI		116	132	mA

NOTES

- Absolute maximum ratings are limiting values to be applied individually, and beyond which the serviceability of the circuit may be impaired. Functional operability is not necessarily implied. Exposure to absolute maximum rating conditions for an extended period of time may affect device reliability.
 - Analog input voltage should not exceed $\pm V_S$.
 - AD9100JD: 0°C to +70°C. AD9100AD: -40°C to +85°C. AD9100SD: -55°C to +125°C. DIP $\theta_{JA} = 38^\circ\text{C/W}$; this is valid with the device mounted flush to a grounded 2 oz copper clad board with 16 sq inches of surface area and no air flow. LCC $\theta_{JA} = 48^\circ\text{C/W}$.
 - The input to the AD9100 is internally clamped at ± 2.3 V. The internal input series resistance is nominally 50 Ω .
 - Hold mode noise is proportional to the length of time a signal is held. For example, if the hold time (t_{H1}) is 20 ns, the accumulated noise is typically 6 μV ($300 \text{ V/s} \times 20 \text{ ns}$). This value must be combined with the track mode noise to obtain total noise.
 - Min and max droop rates are based on the military temperature range (-55°C to +125°C). Refer to the "Droop Rate vs Temperature" chart for min/max limits over the commercial and industrial ranges.
- Specifications subject to change without notice.

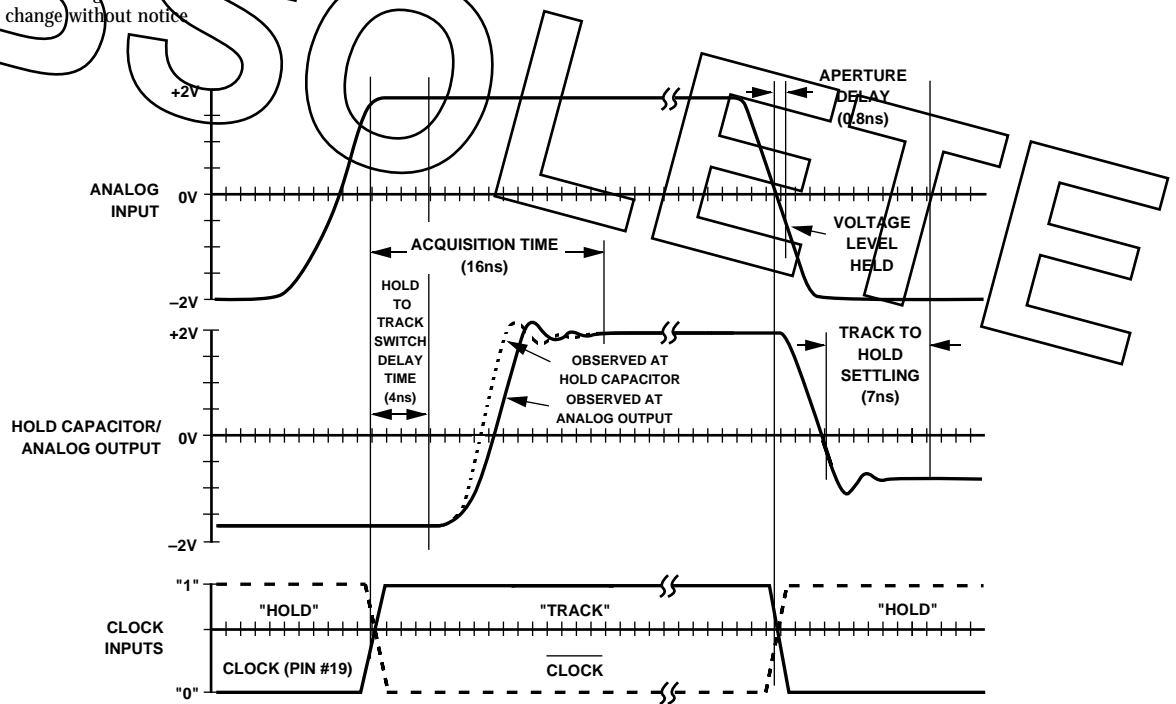

AD9100 Timing Diagram (1 ns/div)

EXPLANATION OF TEST LEVELS

Test Level

- I - 100% production tested.
- II - 100% production tested at +25°C, and sample tested at specified temperatures.
- III - Periodically sample tested.
- IV - Parameter is guaranteed by design and characterization testing.
- V - Parameter is a typical value only.
- VI - All devices are 100% production tested at +25°C. 100% production tested at temperature extremes for extended temperature devices; sample tested at temperature extremes for commercial/industrial devices.

ORDERING GUIDE

Model ¹	Temperature Range	Package Description	Package Option
AD9100JD	0°C to +70°C	Ceramic DIP	D-28
AD9100AD	-40°C to +85°C	Ceramic DIP	D-28
AD9100AE	-40°C to +85°C	Ceramic LCC	E-28A
AD9100SD	-55°C to +125°C	Ceramic DIP	D-28
AD9100SE	-55°C to +125°C	Ceramic LCC	E-28A

NOTE

¹Consult factory about availability of parts screened to MIL-STD-883.

Acquisition Time is the amount of time it takes the AD9100 to reacquire the analog input when switching from hold to track mode. The interval starts at the 50% clock transition point and ends when the input signal is reacquired to within a specified error band at the hold capacitor.

Analog Delay is the time required for an analog input signal to propagate from the device input to output.

Aperture Delay tells when the input signal is actually sampled. It is the time difference between the analog propagation delay of the front-end buffer and the control switch delay time. (The time from the hold command transition to when the switch is opened.) For the AD9100, this is a positive value which means that the switch delay is longer than the analog delay.

Aperture Jitter is the random variation in the aperture delay. This is measured in ps-rms and results in phase noise on the held signal.

Droop Rate is the change in output voltage as a function of time (dV/dt). It is measured at the AD9100 output with the device in hold mode and the input held at a specified dc value. The measurement starts immediately after the T/H switches from track to hold. Feedthrough Rejection is the ratio of the input signal to the output signal when in hold mode. This is a measure of how well the switch isolates the input signal from feeding through to the output.

Hold to Track Switch Delay is the time delay from the track command to the point when the output starts to change and acquire a new signal.

Pedestal Offset is the offset voltage step measured immediately after the AD9100 is switched from track to hold with the input held at zero volts. It manifests itself as an added offset during the hold time.

Track to Hold Settling Time is the time necessary for the track to hold switching transient to settle to within 1 mV of its final value.

Track to Hold Switching Transient is the maximum peak switch induced transient voltage which appears at the AD9100 output when it is switched from track to hold.

THEORY OF OPERATION

The AD9100 utilizes a new track and hold architecture. Previous commercially available high speed track and holds used an open loop input buffer, followed by a diode bridge, hold capacitor, and output buffer (closed or open loop) with a FET device connected to the hold capacitor. This architecture required mixed device technology and, usually, hybrid construction. The sampling rate of these hybrids has been limited to 20 MSPS for 12-bit accuracy. Distortion generated in the front-end amplifier/ bridge limited the dynamic range performance to the "mid-70 dBfs" for analog input signals of less than 10 MHz. Broadband and switch-generated noise limited the SNR of previous track and holds to about 70 dB.

The AD9100 is a monolithic device using a high frequency complementary bipolar process to achieve new levels of high speed precision. Its patent pending architecture breaks from the traditional architecture described above. (See the block diagram

on the first page.) The switching type bridge has been integrated into the first stage closed loop input amplifier. This innovation provides error (distortion) correction for both the switch and amplifier, while still achieving slew rates representative of an open-loop design. In addition, acquisition slew current for the hold capacitor is higher than standard diode bridge and switch configurations, removing a main contributor to the limits of maximum sampling rate and input frequency.

Switching circuits in the device use current steering (versus voltage switching) to provide improved isolation between the switch and analog sections. This results in low aperture time sensitivity to the analog input signal, and reduced power supply and analog switching noise. Track to hold peak switching transient is typically only 6 mV and settles to less than 1 mV in 7 ns. In addition, pedestal sensitivity to analog input voltage is very low (0.6 mV/V) and being first order linear does not significantly affect distortion.

The closed-loop output buffer includes zero voltage bias current cancellation, which results in high-temperature droop rates equivalent to those found in FET type inputs. The buffer also provides first order quasistatic bias correction resulting in an extremely high input resistance and very low droop sensitivity vs. input voltage level (typically less than 1.5 mV/V- μ s.) This closed-loop architecture inherently provides high speed loop correction and results in low distortion under heavy loads.

The extremely fast time constant linearity (7 ns to 0.01% for a 2 V step) ensures that the output buffer does not limit the AD9100 sampling rate or analog input frequency. (The acquisition and settling time are primarily limited only by the input amplifier and switch.) The output is transparent to the overall AD9100 hold mode distortion levels for loads as low as 250 Ω .

Full-scale track and acquisition slew rates achieved by the AD9100 are 800 and 1000 V/ μ s, respectively. When combined with excellent phase margin (typically 5% overshoot), wide bandwidth, and dc gain accuracy, acquisition time to 0.01% is only 16 ns. Though not production tested, settling to 14-bit accuracy (-86 dB distortion @ 2.3 MHz) can be inferred to be 20 ns.

Acquisition Time

Acquisition time is the amount of time it takes the AD9100 to reacquire the analog input when switching from hold to track mode. The interval starts at the 50% clock transition point and ends when the input signal is reacquired to within a specified error band at the hold capacitor.

The hold to track switch delay (t_{DHT}) cannot be subtracted from this acquisition time because it is a charging time delay that occurs when moving from hold to track; this is typically 4 to 6 ns and is the longest delay. Therefore, the track time required for the AD9100 is the acquisition time minus the aperture delay time. Note that the acquisition time is defined as the settled voltage at the hold capacitor and does not include the delay and settling time of the output buffer. The example below illustrates why the output buffer amplifier does not contribute to the overall AD9100 acquisition time.

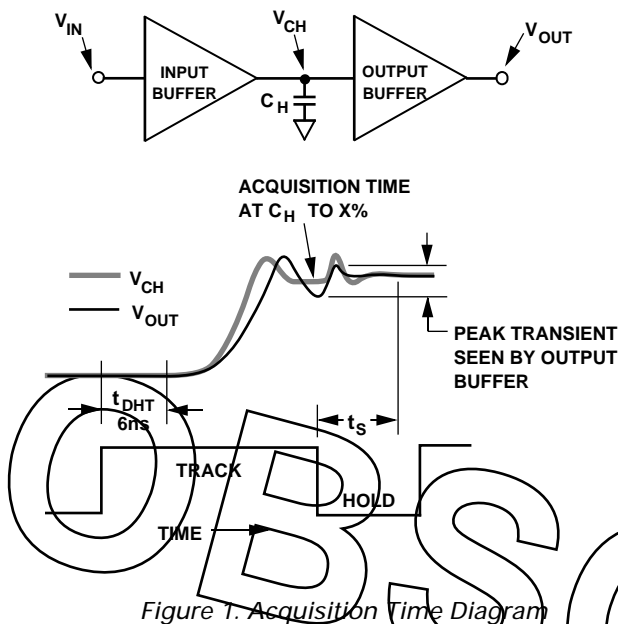

Figure 1. Acquisition Time Diagram

The exaggerated illustration in Figure 1 shows that V_{CH} has settled to within $x\%$ of its final value, but V_{OUT} (due to slew rate limitations, finite BW, power supply ringing, etc.) has not settled during the track time. However, since the output buffer always “tracks” the front end circuitry, it “catches up” during the hold time and directly superimposes itself (less about 600 ps of analog delay) to V_{CH} . Since the small-signal settling time of the output buffer is about 1.8 ns to ± 1 mV and is significantly less than the specified hold time, acquisition time should be referenced to the hold capacitor.

Note that most of the hold settling time and output acquisition time are due to the input buffer and the switch network. For track time, the output buffer contributes only about 5 ns of the total; in hold mode, it contributes only 1.8 ns (as stated above).

A stricter definition of acquisition time would total the acquisition and hold times to a defined accuracy. To obtain 12 bit + distortion levels and 30 MSPS operation, the recommended track and hold times are 20 ns and 13.5 ns, respectively. To drive an 8-bit flash converter with a 2 V p-p full-scale input, hold time to 1 LSB accuracy will be limited primarily by the encoder, rather than by the AD9100. This makes it possible to reduce track time to approximately 13 ns, with hold time chosen to optimize the encoder’s performance.

Hold vs. Track Mode Distortion

In many traditional high speed, open loop track-and-holds, track mode distortion is often much better than hold mode distortion. Track mode distortion does not include nonlinearities due to the switch network, and does not correlate to the relevant hold mode distortion. But since hold mode distortion has traditionally been omitted from manufacturer’s specification tables, users have had to discover for themselves the effective overall hold mode distortion of the combined T/H and encoder.

The architecture of the AD9100 minimizes hold mode distortion over its specified frequency range. As an example, in track mode the worst harmonic generated for a 20 MHz input tone is typically -65 dBfs. In hold mode, under the same conditions and sampling at 30 MSPS, the worst harmonic generated is

-74 dBfs. The reason is the output buffer in hold mode has only dc distortion relevancy. With its inherent linearity (7 ns settling to 0.01%), the output buffer has essentially settled to its dc distortion level even for track plus hold times as short as 30 ns. For a traditional open-loop output buffer, the ac (track mode) and dc (hold mode) distortion levels are often the same.

Droop Rate

Droop rate does not necessarily affect a track and hold’s distortion characteristics. If the droop rate is constant versus the input voltage for a given hold time, it manifests itself as a dc offset to the encoder. For the AD9100, the droop rate is typically ± 1 mV/ μ s. If a signal is held for 1 μ s, a subsequent encoder would see a 1 mV offset voltage. If there is no droop sensitivity to the held voltage value, the 1 mV offset would be constant and “ride” on the input signal and introduce no hold-mode nonlinearities.

In instances in which droop rate varies proportionately to the magnitude of the held voltage signal level, a gain error only is introduced to the A/D encoder. The AD9100 has a droop sensitivity to the input level of 1.5 mV/ V - μ s. For a 2 V p-p input signal, this translates to a 0.15%/ μ s gain error and does not cause additional distortion errors.

For the AD9100, droop sensitivity to input level is insignificant. However, hold times longer than about 2 μ s can cause distortion due to the $R \times C_H$ time constant at the hold capacitor. In addition, hold mode noise will increase linearly vs. hold time and thus degrade SNR performance.

Layout Considerations

For best performance results, good high speed design techniques must be applied. The component (top) side ground plane should be as large as possible; two-ounce copper cladding is preferable. All runs should be as short as possible, and decoupling capacitors must be used.

Figure 2 is the schematic of a recommended AD9100 evaluation board. (Contact factory concerning availability of assembled boards.) All 0.01 μ F decoupling capacitors should be low inductance surface mount devices (P/N 05085C103MT050 from AVX) and connected on the component side within 30 mils of the designated pins; with the other sides soldered directly to the top ground plane.

The 10 μ F low frequency power supply tantalum decoupling capacitors should be located within 1.5 inches of the AD9100. The common 0.01 μ F supply capacitors can be wired together. The common power supply bus (connected to the 10 μ F capacitor and power supply source) can be routed to the underside of the board to the daisy chain wired 0.01 μ F supply capacitors.

For remote input and/or output drive applications, controlled impedances are required to minimize line reflections which will reduce signal fidelity. When capacitive and/or high impedance levels are present, the load and/or source should be physically located within approximately one inch of the AD9100. Note that a series resistance, R_S , is required if the load is greater than 6 pF. (The Recommended R_S vs. CL chart in the “Typical Performance Section” shows values of R_S for various capacitive loads which result in no more than a 20% increase in settling time for loads up to 80 pF.) As much of the ground plane as possible should be removed from around the V_{IN} and V_{OUT} pins to minimize coupling onto the analog signal path.

While a single ground plane is recommended, the analog signal and differential ECL clock ground currents follow a narrow path directly under their common voltage signal line. To reduce reflections, especially when terminations are used for transmission line efficiency, the clock, V_{IN} , and V_{OUT} signals and respective ground paths should not cross each other; if they do, unwanted coupling can result.

High current ground transients via the high frequency decoupling capacitors can also cause unwanted coupling to the V_{IN} and V_{OUT} current loops. Therefore, these analog terminations should be kept as far as possible from the power supply decoupling capacitors to minimize feedthrough.

Using Sockets

Pin sockets (P/N 6-330808-3 from AMP) should be used if the device can not be soldered directly to the PCB. High profile or wire wrap type sockets will dramatically reduce the dynamic performance of the device in addition to increasing the case-to-ambient thermal resistance.

Driving the Encode Clock

The AD9100 requires a differential ECL clock command. Due to the high gain bandwidth of the AD9100 internal switch, the input clock should have a slow rate of at least 100 V/ μ s.

To obtain maximum signal to noise performance, especially at high analog input frequencies, a low jitter clock source is required. The AD9100 clock can be driven by an AD96685, an ultrahigh speed ECL comparator with very low jitter.

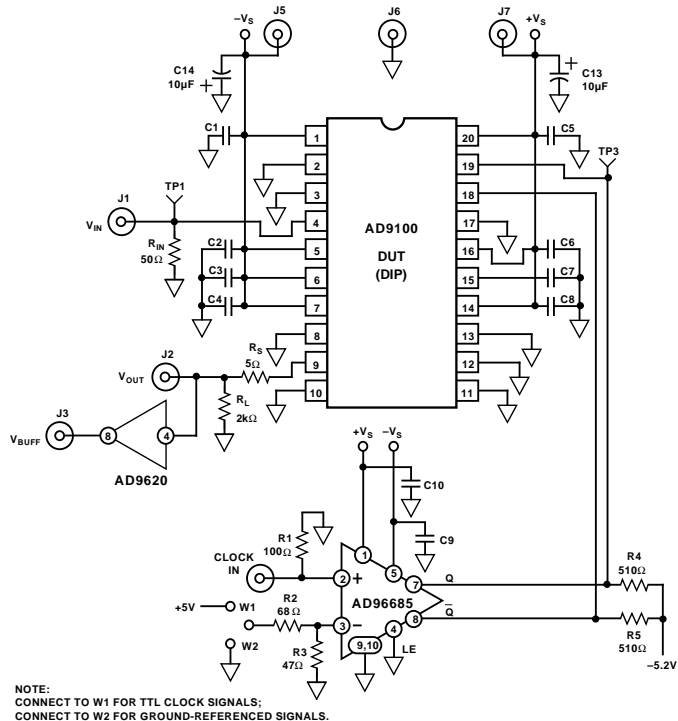
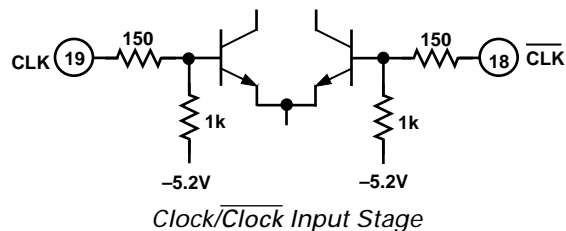

Figure 2. AD9100/PCB Evaluation Board Diagram

Driving the Analog Input

Special care must be taken to ensure that the analog input signal is not compromised before it reaches the AD9100. To obtain maximum signal to noise performance, a very low phase noise analog source is required. In addition, input filtering and/or a low harmonic signal source is necessary to maximize the spurious free dynamic range. Any required filtering should be done close to the AD9100 and away from any digital lines.

Overdriving the Analog Input

The AD9100 has input clamps that prevent hard saturation of the output buffer, thereby providing fast overvoltage recovery when the analog input transitions to the linear region (± 2 V). The clamps are set internally at ± 2.3 V and cannot be altered by the user. The output settles to 0.1% of its value 21 ns after the overvoltage condition is alleviated. When the analog input is outside the linear region, the analog output will be at either +2.2 V or -2.2 V.

Matching the AD9100 to A/D Encoders

The AD9100's analog output level may have to be offset or amplified to match the full-scale range of a given A/D converter. This can generally be accomplished by inserting an amplifier after the AD9100. For example, the AD671 is a 12-bit 500 ns monolithic ADC encoder that requires a 0 to +5 V full-scale analog input. An AD84X series amplifier could be used to condition the AD9100 output to match the full-scale range of the AD671.

Ultralow Distortion/Low Resistive Load Applications

When driving low resistive loads or when the widest possible spurious free dynamic range is required, system performance can be improved by isolating the load from the AD9100. (See Figure 3.) The AD9620 low distortion closed-loop buffer amplifier has an input resistance of 800 k Ω and generates harmonics that are less than those generated by the AD9100. Other buffers should not be considered if their harmonics are not lower than those of the AD9100.

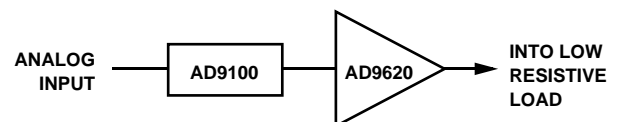

Figure 3. Using AD9620 as Isolation Amplifier

Direct IF Conversion

The AD9100 can be used to sample super-Nyquist signals, making wide dynamic range direct IF to digital conversion practical. By reducing the analog input level to the track and hold, distortion due to the AD9100 can be minimized. As the input level is reduced, the gain in the output amplifier (see Figure 4) must be increased to match the full scale level of the subsequent analog to digital converter.

AD9100

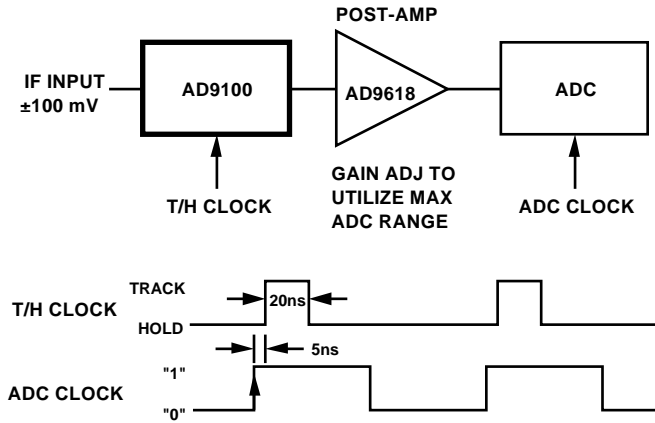

Figure 4. IF Sampling with Track-and-Hold

This technique is not confined to processing Nyquist signals. Figure 5 illustrates the spurious free dynamic range of the AD9100 as a function of analog input signal level and frequency. Without the output amplifier (2 V p-p input), 70 dB+ dynamic range is observed only to about 24 MHz. By reducing the analog input to 200 mV p-p, >70 dB SFDR can be maintained to 70 MHz IFs.

The optimum T/H input level for a particular IF can be determined by examining the T/H spurious and noise performance. The highest input signal level which will provide the required SFDR gives the lowest noise performance. When sampling super Nyquist signals, the IF will be aliased to baseband and can be observed by using FFT analysis.

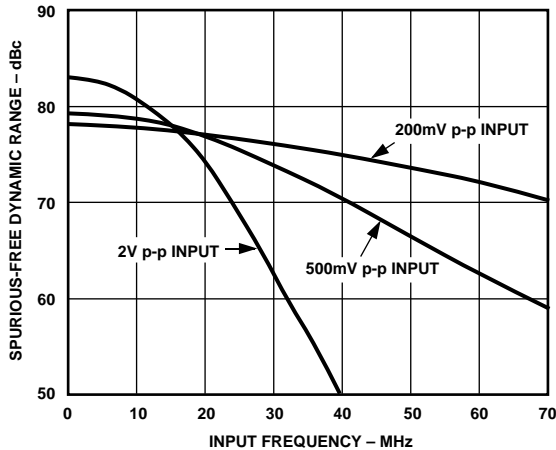

Figure 5. AD9100 SFDR vs. Input Frequency at 10 MSPS

In the FFT spectrum below (see Figure 6), the 71.4 MHz IF is observed at 1.4 MHz. Note that the highest frequency observed (FS/2) is determined by the sample rate of the T/H.

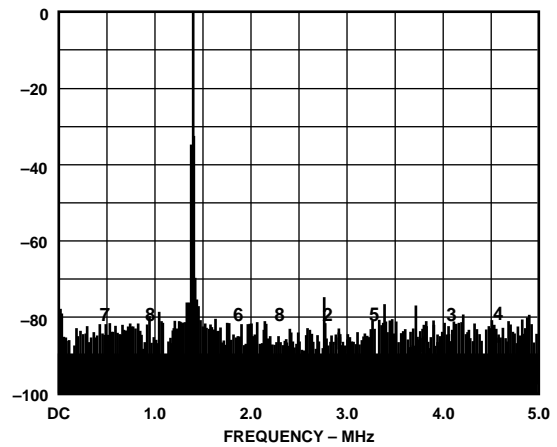

Figure 6. 71.4 MHz Signal Sampled at 10 MSPS with 200 mV p-p Input

Low Noise Applications

When processing low level single event signals in which noise performance is the primary concern, amplification ahead of the AD9100 can increase overall system signal to noise ratio. Front-end amplification often results in an increase in hold mode distortion levels because of the track mode limitations of the amplifier which is used. Depending on the signal levels and bandwidth, the AD9618 low noise high gain amplifier is a possible candidate for this application. See Figure 7.

As a general rule, if the goal is maximize SNR (minimize noise), pre-AD9100 amplification is recommended. When the system goal is to maximize the spurious free dynamic range (minimize distortion), post-AD9100 amplification is recommended.

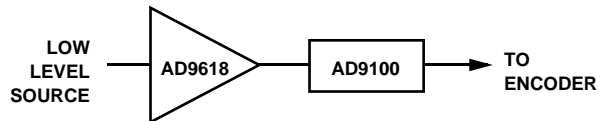
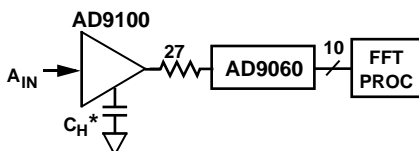
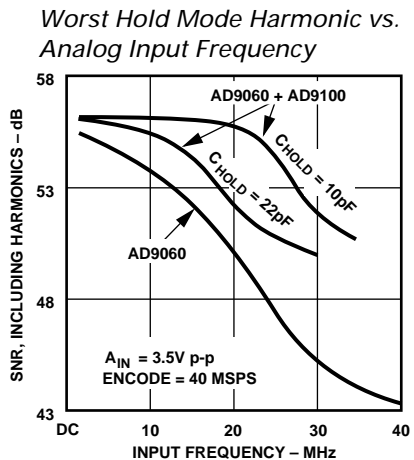
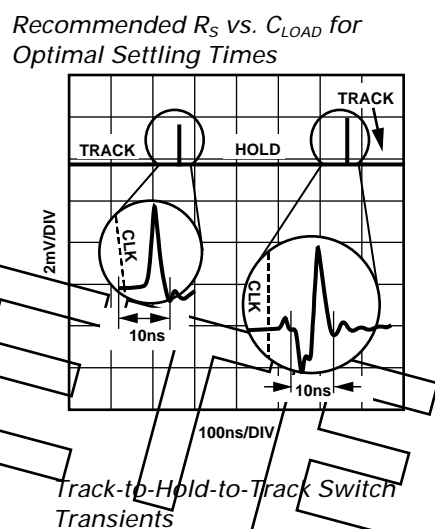
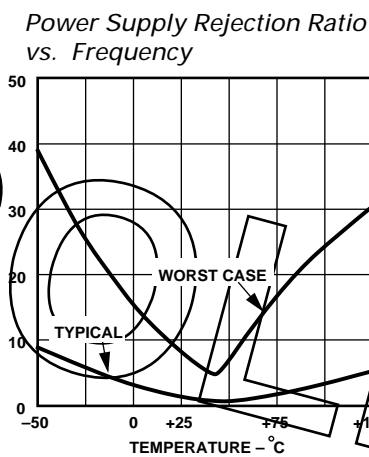
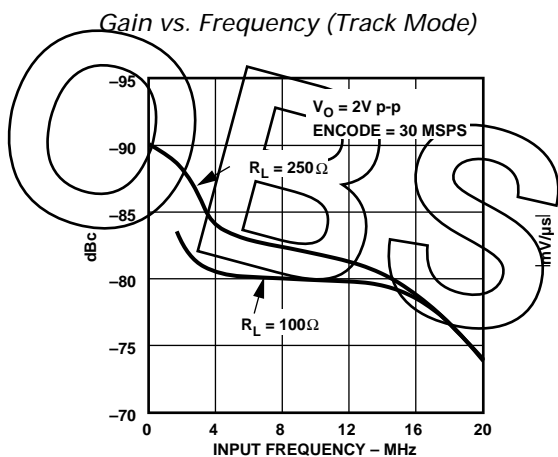
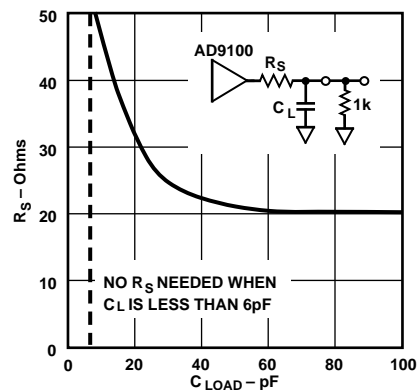
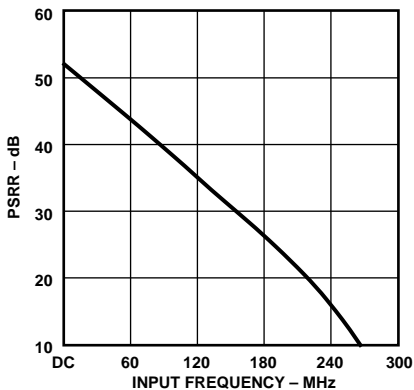
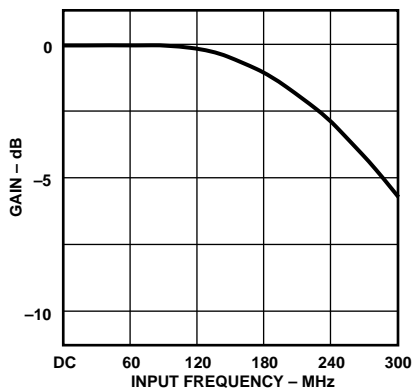
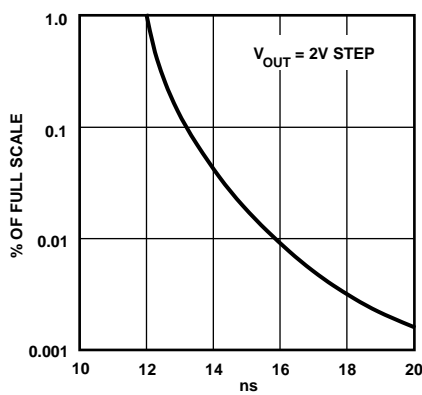
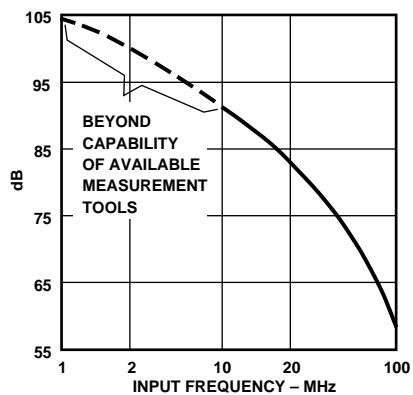
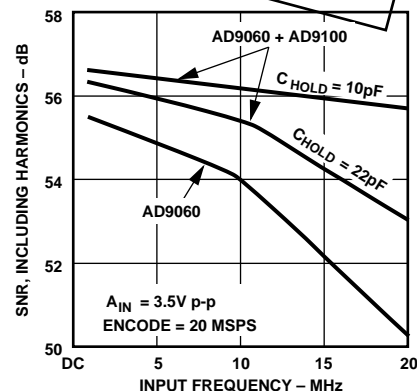

Figure 7. Using AD9618 as Pre-Amp for AD9100



THE AD9060 IS A 10-BIT, 75MSPS MONOLITHIC ADC FROM ANALOG DEVICES.
 * THE AD9100XD (DIP) HAS AN INTERNAL 22pF HOLD CAPACITOR. CONTACT FACTORY REGARDING AVAILABILITY OF AD9100 IN A 28-PIN LEADED CHIP CARRIER PACKAGE WITH EXTERNAL HOLD CAPACITOR.



AD9100

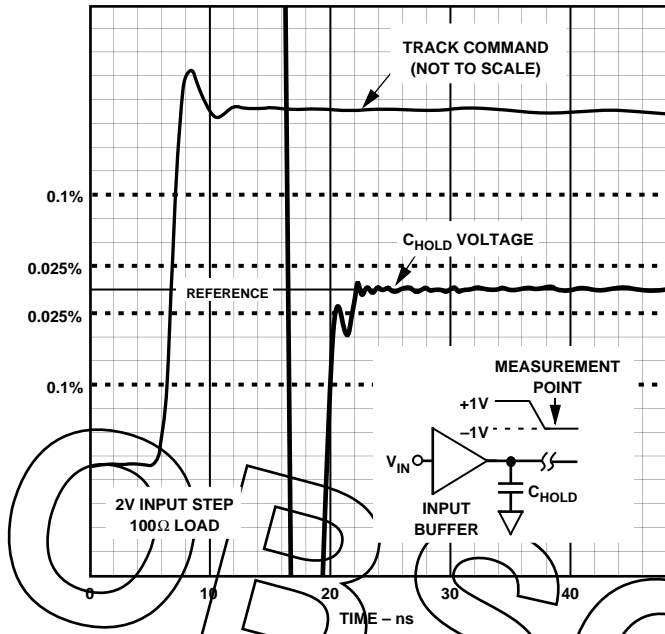

AD9100 Acquisition Time

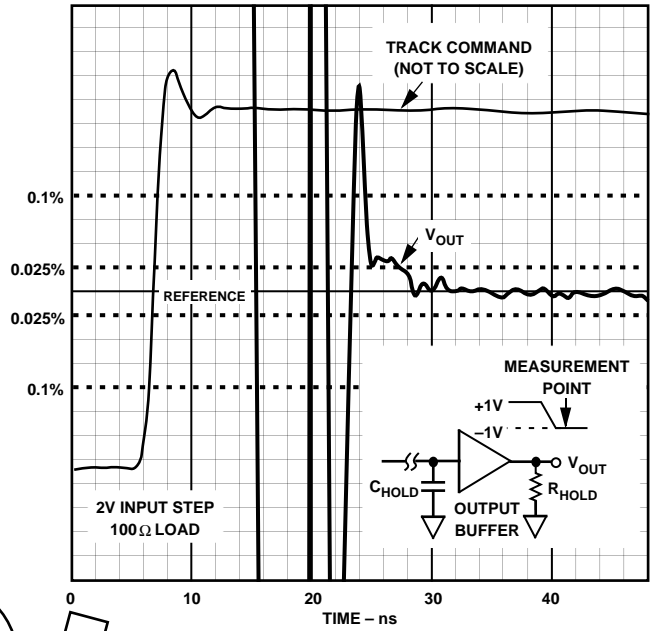

AD9100 Output Acquisition Time

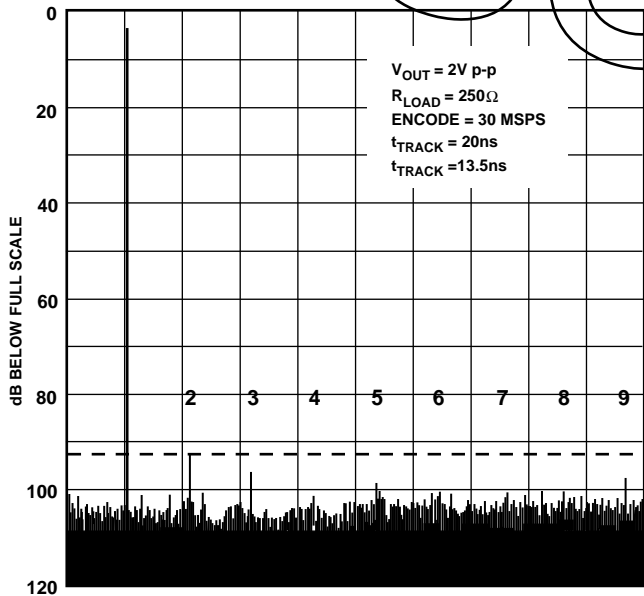

Frequency (500 kHz/Division) Analog Input = 540 kHz

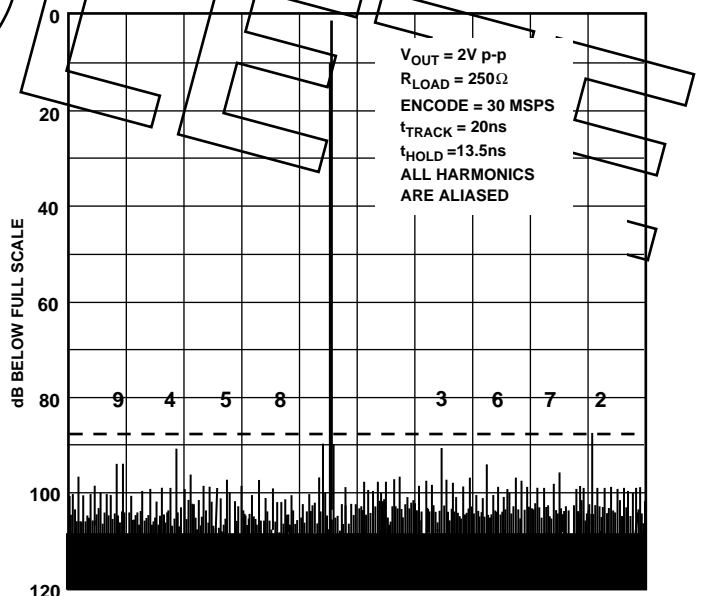

Frequency (500 kHz/Division) Analog Input = 2.3 MHz

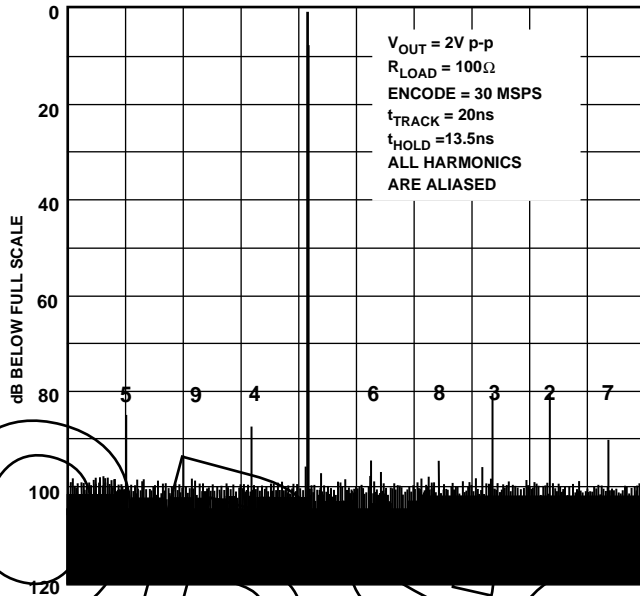

Frequency (500 kHz/Division) Analog Input = 12.1 MHz

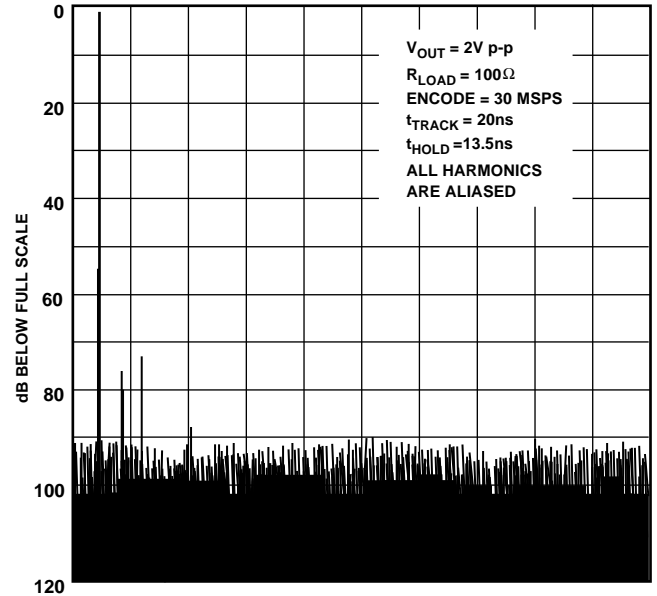

Frequency (500 kHz/Division) Analog Input = 19.8 MHz

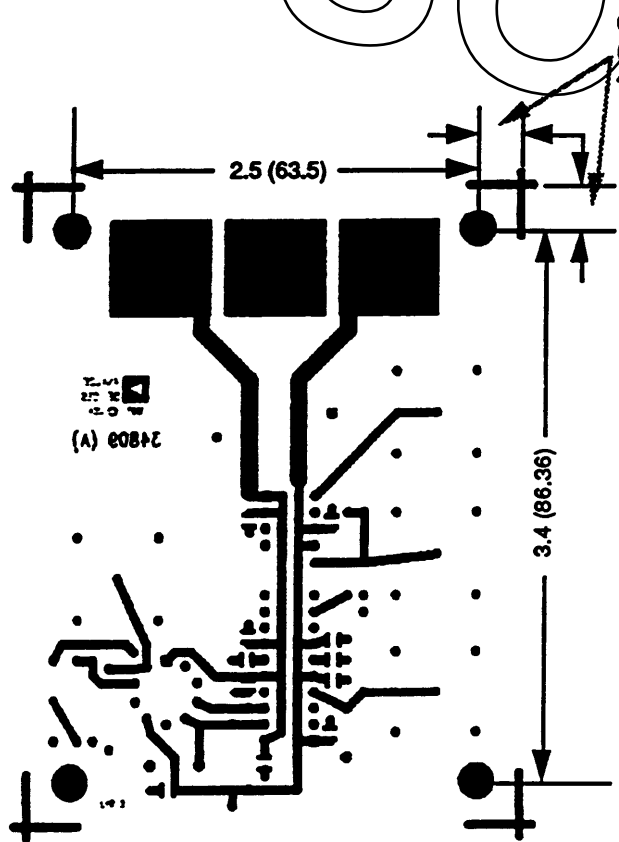

Bottom of AD9100/PCB Evaluation Board Viewed from Above

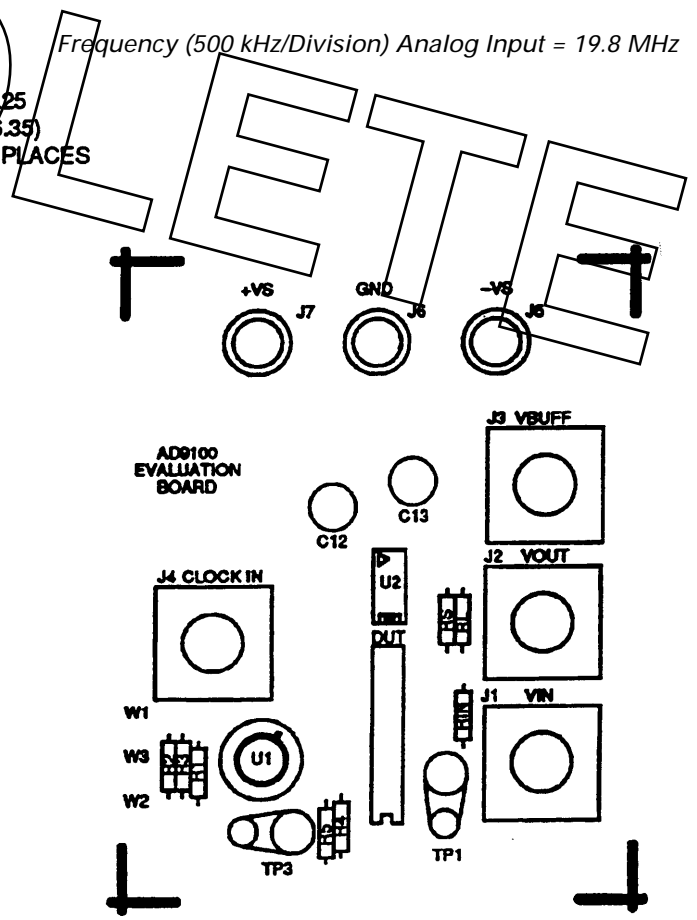

Top of AD9100/PCB Evaluation Board Viewed from Above

EVALUATION BOARD ORDERING INFORMATION

Part Number	Description
AD9100/PWB	Printed Wiring Board (Only) of Evaluation Circuit
AD9100/PCB	Evaluation Board for AD9100T/H, Assembled and Tested [Order AD9100T/H (DIP) Separately]

OUTLINE DIMENSIONS
 Dimensions shown in inches and (mm).

20-Pin Side-Brazed Ceramic DIP

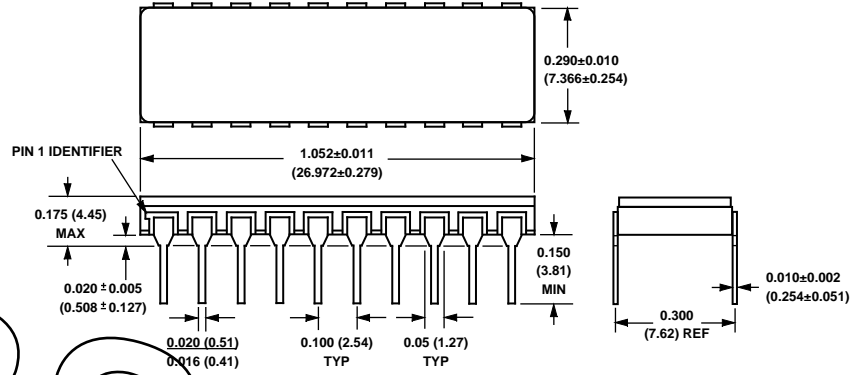

28-Pin LCC Package

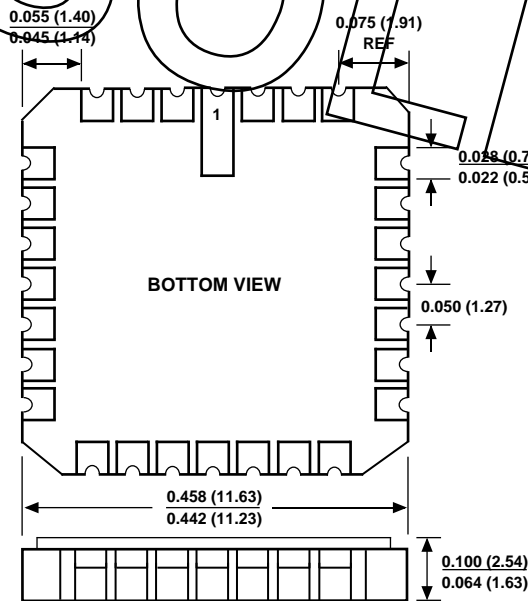

OBSOLETE