

### Ceramic Resonators, Chip Type (3 Array Type)

- Type: **EFO**S
- Type: **EFO**B
- Type: **EFO**SS
- Type: **EFO**SM
- Type: **EFO**BM
- Type: **EFO**JM



#### ■ Features

- Encased in a ceramic package
- High reliability against soldering heat and mechanical stress
- Moisture-proof sealing
- 1.2 mm maximum (SS/SM/BM/JM),
- Designed for reflow soldering
- Flat-bottom plate for better mountings
- Simplifies oscillation circuits by reducing the number of circuit parts
- RoHS compliant

#### ■ Recommended Applications

- Clock generator for microprocessors
- Carrier circuit between telecommunication equipment (Telephone to telephone, personal computer to printer)

#### ■ Handling Precautions (See Page 175 to 176)

#### ■ Packaging Specifications

See Page 169 to 177

#### ■ Explanation of Part Numbers

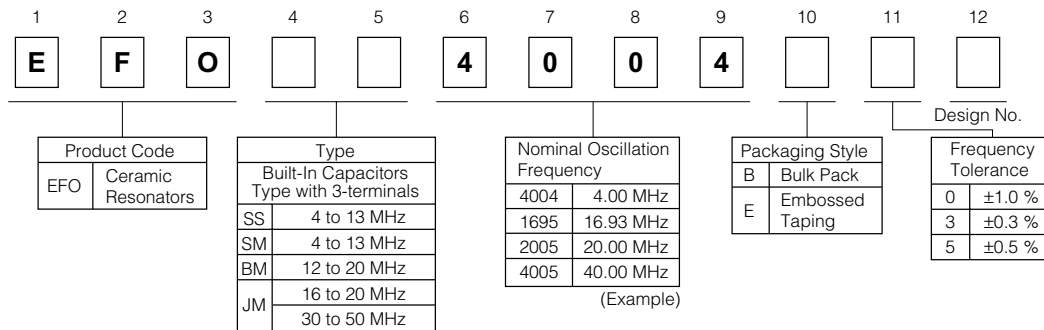
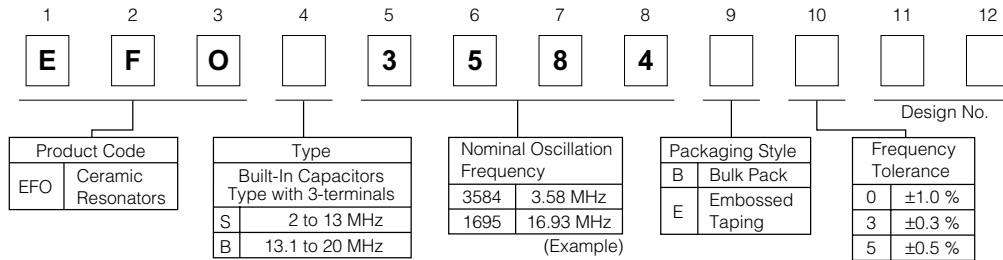

Part Number	Frequency range (MHz)	Frequency Temperature Characteristics (-20 to +80 °C)	Built-in Capacitors (Reference)
EFO	2.00 to 8.39	±0.2 %	33 pF
	8.40 to 13.0	±1.0 %	
EFOB	13.1 to 20.0	±0.5 %	33 pF
	4.00 to 8.39	±0.2 %	
EFOSS	8.40 to 13.0	±0.3 %	21 pF
	4.00 to 8.39	±0.2 %	
EFOSM	8.40 to 13.0	±1.0 %	33 pF
	12.0 to 20.0	±0.3 %	
EFOBM	16.0 to 20.0	±0.5 %	18 pF
	30.0 to 50.0	±0.2 %	
EFOJM			10 pF

Design and specifications are each subject to change without notice. Ask factory for the current technical specifications before purchase and/or use. Should a safety concern arise regarding this product, please be sure to contact us immediately.

01 Feb. 2009

■ Dimensions in mm (not to scale)  
 Recommended Land Dimensions  
 [Type EFOS].....2.0 to 13.0 MHz

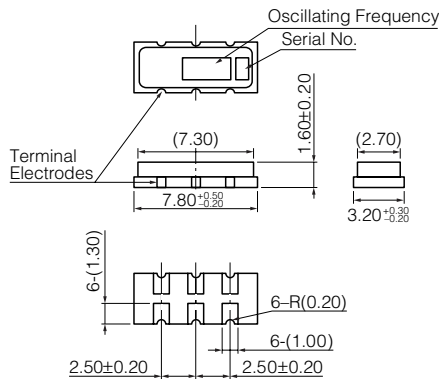

[Type EFOS, EFOSM]

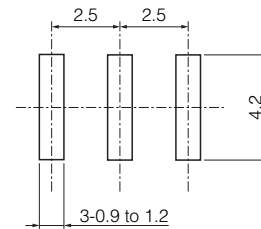

[Type EFOSM].....4.0 to 13.0 MHz

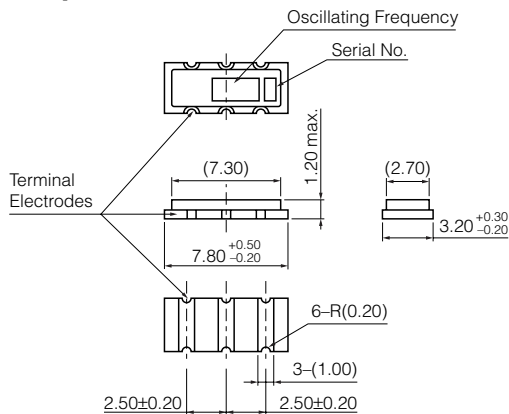

[Type EFOSS].....4.0 to 13.0 MHz

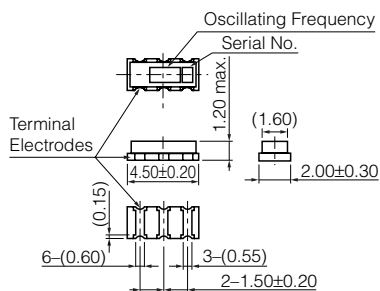

[Type EFOSS]

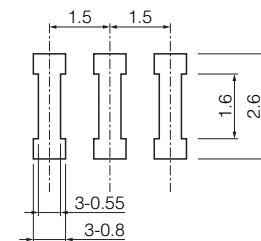

[Type EFOB].....13.1 to 20.0 MHz

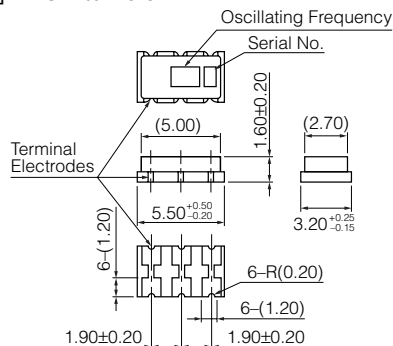

[Type EFOB]

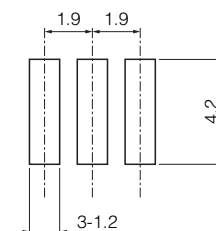

Design and specifications are each subject to change without notice. Ask factory for the current technical specifications before purchase and/or use. Should a safety concern arise regarding this product, please be sure to contact us immediately.

01 Feb. 2009

■ Dimensions in mm (not to scale)  
 Recommended Land Dimensions  
 [Type EFOBM].....12.0 to 20.0 MHz

[Type EFOBM]

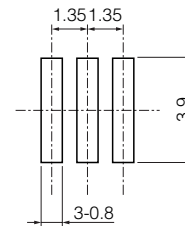
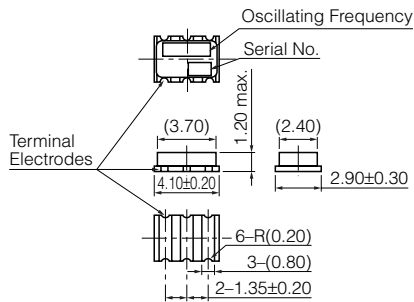

[Type EFOJM].....16.0 to 20.0, 30.0 to 50.0 MHz

[Type EFOJM]

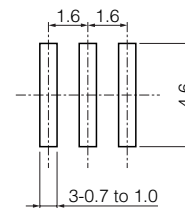
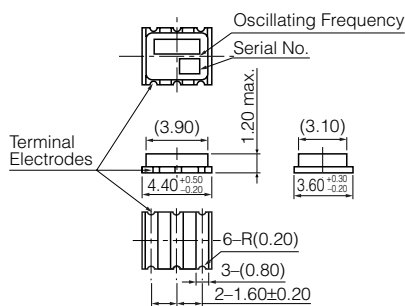

### ■ Test Circuits Diagram

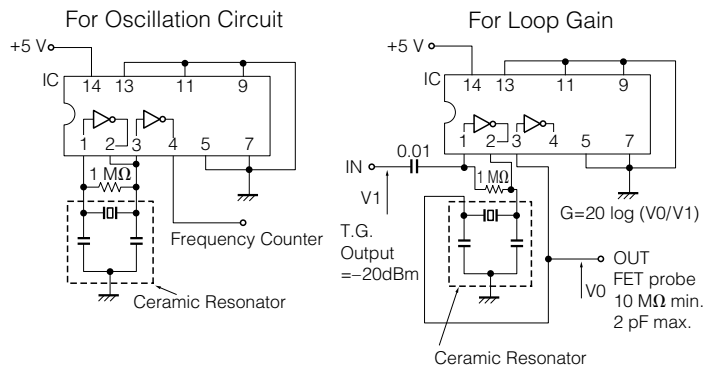

Frequency	IC
2.00 to 8.39 MHz	μPD4069UBC, TC4069UBP or similar
8.40 to 50.0 MHz	μPD74HCU, TC74 HCU04AP or similar

### Typical Characteristics ..... Temperature Characteristics

Type EFOS

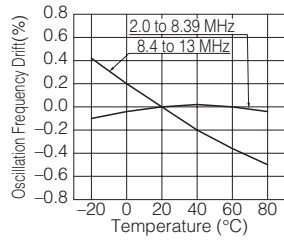

Type EFOB

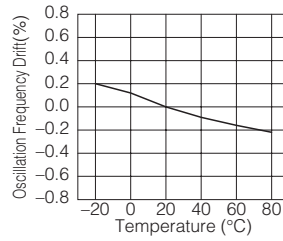

Type EFOSS

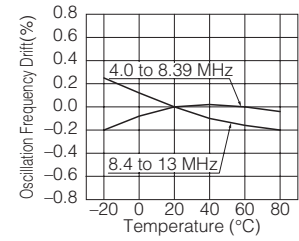

Type EFOSM

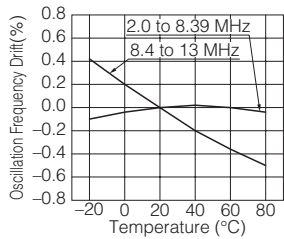

Type EFOBM

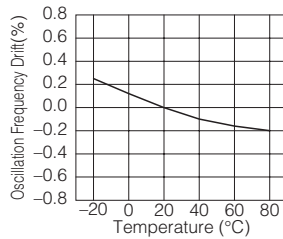

Type EFOJM

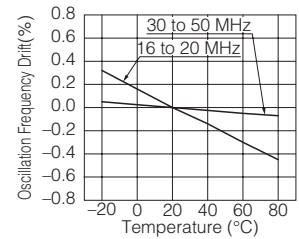

### Packaging Specifications

#### Standard Packing Quantity

Type	Embossed Taping	Bulk
EFOS, EFOSM	2500 pcs./reel	500 pcs./bag
EFOSS	2000 pcs./reel	
EFOB, EFOBM, EFOJM	1000 pcs./reel	

#### Dimensions for Reel in mm (not to scale)

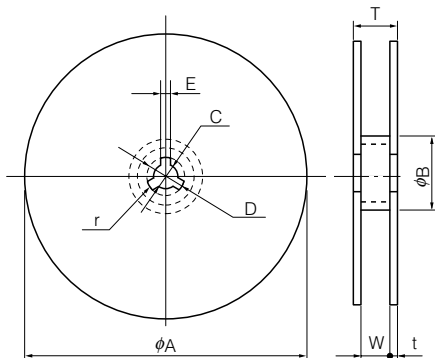

[Type EFOS, EFOSM]

Dim. (mm)	φA	φB	C	D	E
	330±5	80 min.	13.0±0.5	21.0±0.8	2.0±0.5

Dim. (mm)	W	T	t	r
	16.4 <sup>+2.0</sup> <sub>0</sub>	22.4 max.	3 max.	1.0

[Type EFOSS, EFOB, EFOBM, EFOJM]

Dim. (mm)	φA	φB	C	D	E
	180±5	60 min.	13.0±0.5	21.0±0.8	2.0±0.5

Dim. (mm)	W	T	t	r
	12.4 <sup>+2.0</sup> <sub>0</sub>	18.4 max.	3 max.	1.0

Design and specifications are each subject to change without notice. Ask factory for the current technical specifications before purchase and/or use. Should a safety concern arise regarding this product, please be sure to contact us immediately.

01 Feb. 2009

### [Type EFOS, EFOSM]

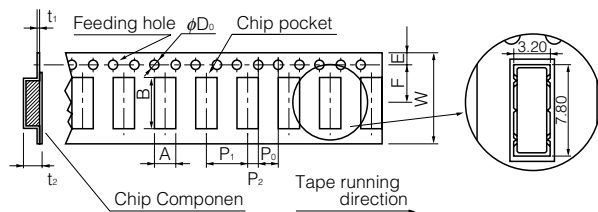

Dim. (mm)	A	B	W	F	E	P <sub>1</sub>
	3.7±0.2	8.3±0.2	16.0±0.3	7.5±0.1	1.75±0.10	8.0±0.1
Dim. (mm)	P <sub>2</sub>	P <sub>0</sub>	φD <sub>0</sub>	t <sub>1</sub>	t <sub>2</sub>	
	2.0±0.1	4.0±0.1	1.5 <sup>+0.1</sup> <sub>0</sub>	0.3	3.5 max.	

### [Type EFOSS]

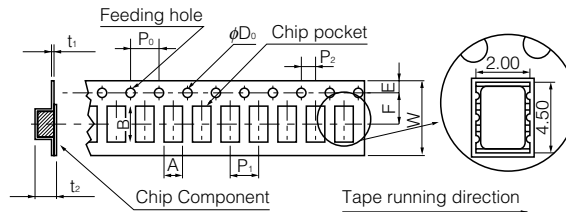

Dim. (mm)	A	B	W	F	E	P <sub>1</sub>
	2.6±0.2	5.1±0.2	12.0±0.3	5.5±0.1	1.75±0.10	4.0±0.1
Dim. (mm)	P <sub>2</sub>	P <sub>0</sub>	φD <sub>0</sub>	t <sub>1</sub>	t <sub>2</sub>	
	2.0±0.1	4.0±0.1	1.5 <sup>+0.1</sup> <sub>0</sub>	0.6 max.	3.0 max.	

### [Type EFOB, EFOBM, EFOJM]

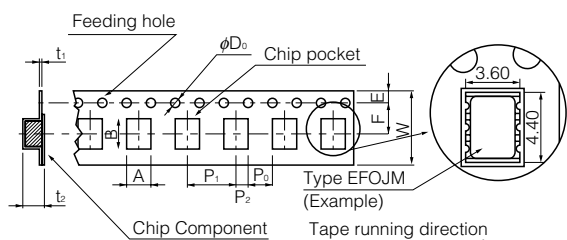

Dim. (mm)	A	B	W	F	E	P <sub>1</sub>
	①	②	12.0±0.3	5.5±0.1	1.75±0.10	8.0±0.1
Dim. (mm)	P <sub>2</sub>	P <sub>0</sub>	φD <sub>0</sub>	t <sub>1</sub>	t <sub>2</sub>	
	2.0±0.1	4.0±0.1	1.5 <sup>+0.1</sup> <sub>0</sub>	0.6 max.	3.0 max.	

Dim. (mm)	A	B
	①	②
Type EFOB	3.7±0.2	6.0±0.2
Type EFOBM	3.4±0.2	4.6±0.2
Type EFOJM	4.1±0.2	4.9±0.2