



82540EP Gigabit Ethernet Controller

Networking Silicon

Datasheet

Product Features

- PCI Bus
 - PCI Revision 2.3 support for 32-bit wide interface at 33 MHz and 66 MHz
 - Algorithms that optimally use advanced PCI, MWI, MRM, and MRL commands
 - CardBus Information Services (CIS) Pointer
 - CLK_RUN# Signal
- MAC Specific
 - Low-latency transmit and receive queues
 - IEEE 802.3x-compliant flow-control support with software-controllable thresholds
 - Caches up to 64 packet descriptors in a single burst
 - Programmable host memory receive buffers (256 B to 16 KB) and cache line size (16 B to 256 B)
 - Wide, optimized internal data path architecture
 - 64 KB configurable Transmit and Receive FIFO buffers
- PHY Specific
 - Integrated for 10/100/1000 Mb/s operation
 - IEEE 802.3ab Auto-Negotiation support
 - IEEE 802.3ab PHY compliance and compatibility. State-of-the-art DSP architecture implements digital adaptive equalization, echo cancellation, and cross-talk cancellation
 - Automatic detection of cable lengths and MDI vs. MDI-X cable at all speeds
- Host Off-Loading
 - Transmit and receive IP, TCP, and UDP checksum off-loading capabilities
 - Transmit TCP segmentation
 - Advanced packed filtering
 - Jumbo frame support up to 16 KB
 - IEEE 802.1q VLAN support with VLAN tag insertion, stripping and packet filtering for up to 4096 VLAN tags
 - Descriptor ring management hardware for transmit and receive
 - Interrupt coalescing (multiple packets per interrupt)
- Manageability
 - Manageability features: Onboard SMB port, ASF 1.0, ACPI, Wake on LAN, and PXE
 - Compliance with PCI Power Management 1.1 and ACPI 2.0 register set compliant
 - SNMP and RMON statistic counters
 - SDG 3.0, WfM 2.0, and PC2001 compliance
- Additional Device
 - Four activity and link indication outputs that directly drive LEDs
 - JTAG (IEEE 1149.1) Test Access Port built in silicon
 - Internal PLL for clock generation can use a 25 MHz crystal
 - Programmable LED functionality
 - Industrial temperature support (-40 to +85 °C)

317887-001
Revision 1.9



INFORMATION IN THIS DOCUMENT IS PROVIDED IN CONNECTION WITH INTEL PRODUCTS. NO LICENSE, EXPRESS OR IMPLIED, BY ESTOPPEL OR OTHERWISE, TO ANY INTELLECTUAL PROPERTY RIGHTS IS GRANTED BY THIS DOCUMENT. EXCEPT AS PROVIDED IN INTEL'S TERMS AND CONDITIONS OF SALE FOR SUCH PRODUCTS, INTEL ASSUMES NO LIABILITY WHATSOEVER, AND INTEL DISCLAIMS ANY EXPRESS OR IMPLIED WARRANTY, RELATING TO SALE AND/OR USE OF INTEL PRODUCTS INCLUDING LIABILITY OR WARRANTIES RELATING TO FITNESS FOR A PARTICULAR PURPOSE, MERCHANTABILITY, OR INFRINGEMENT OF ANY PATENT, COPYRIGHT OR OTHER INTELLECTUAL PROPERTY RIGHT.

Intel products are not intended for use in medical, life saving, or life sustaining applications.

Intel may make changes to specifications and product descriptions at any time, without notice.

Designers must not rely on the absence or characteristics of any features or instructions marked "reserved" or "undefined." Intel reserves these for future definition and shall have no responsibility whatsoever for conflicts or incompatibilities arising from future changes to them.

The Intel products referenced in this document may contain design defects or errors known as errata which may cause the product to deviate from published specifications. Current characterized errata are available on request.

Contact your local Intel sales office or your distributor to obtain the latest specifications and before placing your product order.

Copies of documents which have an ordering number and are referenced in this document, or other Intel literature, may be obtained from:

Intel Corporation
P.O. Box 5937
Denver, CO 80217-9808

or call in North America 1-800-548-4725, Europe 44-0-1793-431-155, France 44-0-1793-421-777, Germany 44-0-1793-421-333, other Countries 708-296-9333

Intel® is a trademark or registered trademark of Intel Corporation or its subsidiaries in the United States and other countries.

*Other names and brands may be claimed as the property of others.

Copyright © Intel Corporation, 2002-2007



Revision History

Date	Revision	Notes
Apr 2002	0.25	Initial Release
Nov 2002	1.0	Changed document status to Intel Confidential.
Jan 2003	1.1	Section 1.0. Replaced Block Diagram Section 2.6. Added Table footnote Section 4.1, 4.2, 4.3. Replaced tables Section 5.1. Added Visual Pin Reference Section 4.4 Removed Power Supply Characteristics; added note to I/O Characteristics Section 5.0 Replaced Pinout Diagram
Apr 2003	1.2	Removed confidential status. Section 1.0. Added product ordering code.
Oct 2003	1.3	Updated Table 8 to reflect correct values for internal pull-up impedance.
Nov 2004	1.4	Added product features to cover. Updated signal names to match design guide and reference schematics.
Nov 2004	1.5	Added information about migrating from a 2-layer 0.36 mm wide-trace substrate to a 2-layer 0.32 mm wide-trace substrate. Refer to the section on Package and Pinout Information. Added statement that no changes to existing soldering processes are needed for the 2-layer 0.32 mm wide-trace substrate change in the section describing "Package Information". Corrected pinout discrepancies between Tables 35 and 36.
July 2006	1.6	Added LAN-disable description to the FLSH_SO signal description in Section 3.
Sept 2006	1.7	Added industrial temperature values to "Product Features" and Table 2. Added a note to Figure 12 clarifying the device pin 1 location.
Feb 2007	1.8	Updated Section 5.3 "Thermal Specifications".
Sept 2007	1.9	Updated ball G13 description to 1.5V. Updated Figure 12 (changed G13 description to 1.5V).



Note: This page intentionally left blank.



Contents

1.0	Introduction.....	1
1.1	Document Scope	1
1.2	Reference Documents	2
1.3	Block Diagram	3
2.0	Product Code	5
3.0	Signal Descriptions	7
3.1	Signal Type Definitions	7
3.2	PCI Bus Interface.....	7
3.2.1	PCI Address, Data and Control Signals.....	7
3.2.2	Arbitration Signals.....	9
3.2.3	Interrupt Signal	9
3.2.4	System Signals	9
3.2.5	Error Reporting Signals	9
3.2.6	Power Management Signals.....	10
3.2.7	Impedance Compensation Signals	10
3.2.8	SMB Signals	10
3.3	EEPROM and Serial FLASH Interface Signals.....	10
3.4	Miscellaneous Signals	11
3.4.1	LED Signals	11
3.4.2	Other Signals	11
3.5	PHY Signals.....	12
3.5.1	Crystal Signals.....	12
3.5.2	Analog Signals.....	12
3.6	Test Interface Signals	13
3.7	Power Supply Connections.....	13
3.7.1	Digital Supplies	13
3.7.2	Analog Supplies	13
3.7.3	Ground and No Connects	14
3.7.4	Control Signals	14
4.0	Voltage, Temperature, and Timing Specifications	15
4.1	Absolute Maximum Ratings	15
4.2	Recommended Operating Conditions.....	15
4.3	DC Specifications	16
4.4	AC Characteristics	19
4.5	Timing Specifications.....	20
4.5.1	PCI Bus Interface.....	20
4.5.2	Link Interface Timing	24
4.5.3	EEPROM Interface	25



5.0	Package and Pinout Information	27
5.1	Device Identification	27
5.2	Package Information.....	28
5.3	Thermal Specifications	29
5.4	Pinout Information	30
5.5	Visual Pin Reference	39



1.0 Introduction

The Intel® 82540EP Gigabit Ethernet Controller is a single, compact component with an integrated Gigabit Ethernet Media Access Control (MAC) and physical layer (PHY) functions. For desktop, workstation and mobile PC Network designs with critical space constraints, the Intel® 82540EP allows for a Gigabit Ethernet implementation in a very small area that is footprint compatible with current generation 10/100 Mbps Fast Ethernet designs

The Intel® 82540EP integrates Intel's fourth generation gigabit MAC design with fully integrated, physical layer circuitry to provide a standard IEEE 802.3 Ethernet interface for 1000BASE-T, 100BASE-TX, and 10BASE-T applications (802.3, 802.3u, and 802.3ab). The controller is capable of transmitting and receiving data at rates of 1000 Mbps, 100 Mbps, or 10 Mbps. In addition to managing MAC and PHY layer functions, the controller provides a 32-bit wide direct Peripheral Component Interconnect (PCI) 2.2 compliant interface capable of operating at 33 or 66 MHz.

The 82540EP also incorporates the CLK_RUN# protocol and hardware supported downshift capability to two or three-pair 100 Mb/s operation. These features optimize mobile applications.

The Intel® 82540EP's on-board System Management Bus (SMB) port enables network manageability implementations required by information technology personnel for remote control and alerting via the LAN. With SMB, management packets can be routed to or from a management processor. The SMB port enables industry standards, such as Intelligent Platform Management Interface (IPMI) and Alert Standard Forum (ASF), to be implemented using the 82540EP. In addition, on chip ASF 1.0 circuitry provides alerting and remote control capabilities with standardized interfaces.

The 82540EP Gigabit Ethernet Controller architecture is designed to deliver high performance and PCI bus efficiency. Wide internal data paths eliminate performance bottlenecks by efficiently handling large address and data words. The 82540EP controller includes advanced interrupt handling features to limit PCI bus traffic and a PCI interface that maximizes the use of bursts for efficient bus usage. The 82540EP caches up to 64 packet descriptors in a single burst for efficient PCI bandwidth use. A large 64 KByte on-chip packet buffer maintains superior performance as available PCI bandwidth changes. In addition, using hardware acceleration, the controller offloads tasks from the host controller, such as TCP/UDP/IP checksum calculations and TCP segmentation.

The 82540EP is packaged in a 15 mm² 196-ball grid array and is pin compatible with both the 82551QM 10/100 Mbps Fast Ethernet Multifunction PCI/CardBus Controller and the 82540EM Gigabit Ethernet Controller (which does not have added power saving features like CLK_RUN#).

1.1 Document Scope

This document contains datasheet specifications for the 82540EP Gigabit Ethernet Controller, including signal descriptions, DC and AC parameters, packaging data, and pinout information.



1.2 Reference Documents

This application assumes that the designer is acquainted with high-speed design and board layout techniques. The following documents provide additional information:

- 82544EI/82544GC Gigabit Ethernet Controller Software Developer's Manual, Revision 0.25, Intel Corporation.
- PCI Local Bus Specification, Revision 2.3, PCI Special Interest Group.
- PCI Bus Power Management Interface Specification, Rev. 1.1, PCI Special Interest Group.
- IEEE Standard 802.3, 1996 Edition, Institute of Electrical and Electronics Engineers (IEEE).
- IEEE Standard 802.3u, 1995 Edition, Institute of Electrical and Electronics Engineers (IEEE).
- IEEE Standard 802.3x, 1997 Edition, Institute of Electrical and Electronics Engineers (IEEE).
- IEEE Standard 802.3z, 1998 Edition, Institute of Electrical and Electronics Engineers (IEEE).
- IEEE Standard 802.3ab, 1999 Edition, Institute of Electrical and Electronics Engineers (IEEE).
- Intel Ethernet Controllers Timing Device Selection Guide, AP-419, Intel Corporation.
- PCI Mobile Design Guide, Rev. 1.1, PCI Special Interest Group
- 82540EP/82541(PI/GI/EI) & 82562EZ(EX) Dual Footprint Design Guide, AP-444. Intel Corporation.

1.3 Block Diagram

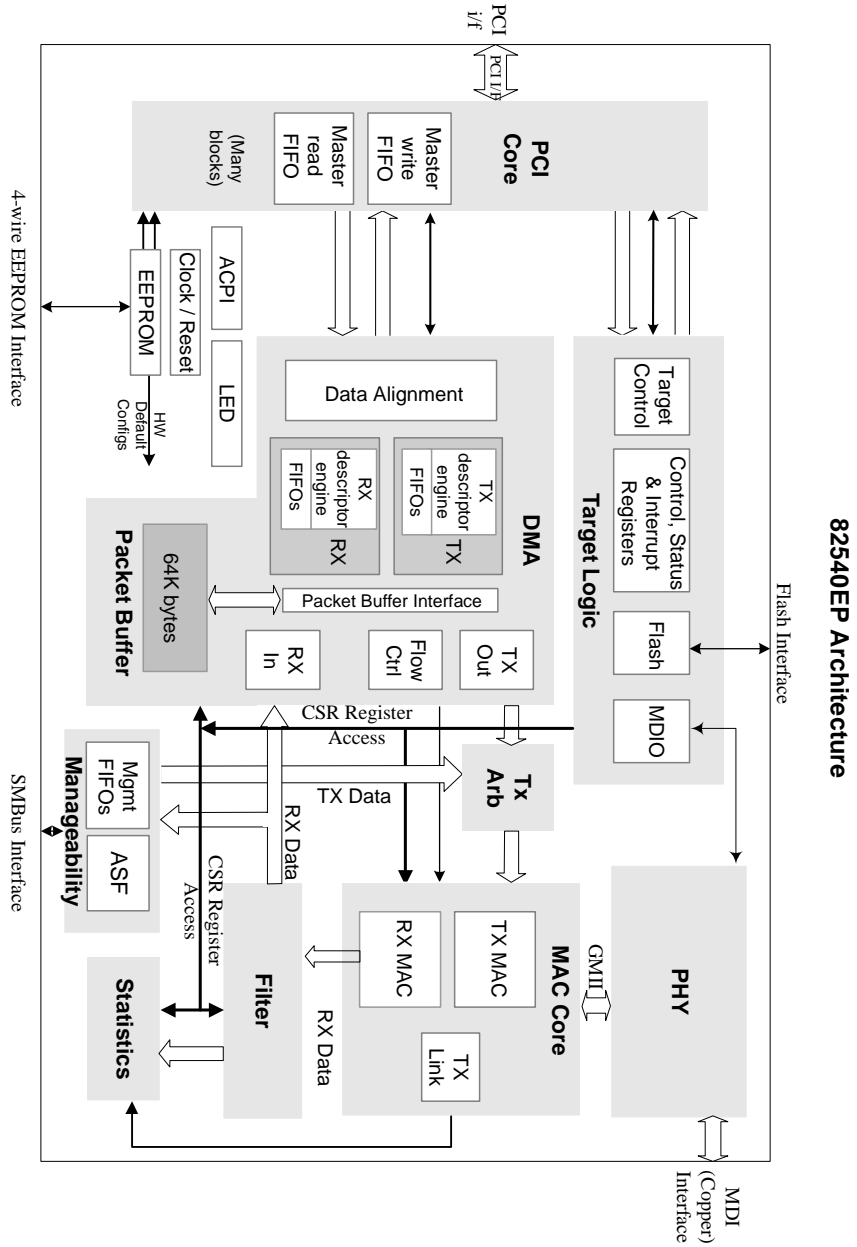

Figure 1. Gigabit Ethernet Controller Block Diagram



Note: This page is intentionally left blank.



2.0 Product Code

The product ordering code for the 82540EP is: RC82540EP.



Note: This page intentionally left blank.



3.0 Signal Descriptions

Note: The targeted signal names are subject to change without notice. Verify with your local Intel sales office that you have the latest information before finalizing a design.

3.1 Signal Type Definitions

The signals of the 82540EP controller are electrically defined as follows:

Name	Definition
I	Input. Standard input only digital signal.
O	Output. Standard output only digital signal.
TS	Tri-state. Bi-directional three-state digital input/output signal.
STS	Sustained Tri-state. Sustained digital three-state signal driven by one agent at a time. An agent driving the STS pin low must actively drive it high for at least one clock before letting it float. The next agent of the signal cannot drive the pin earlier than one clock after it has been released by the previous agent.
OD	Open Drain. Wired-OR with other agents. The signaling agent asserts the OD signal, but the signal is returned to the inactive state by a weak pull-up resistor. The pull-up resistor may require two or three clock periods to fully restore the signal to the de-asserted state.
A	Analog. PHY analog data signal.
P	Power. Power connection, voltage reference, or other reference connection.

3.2 PCI Bus Interface

When the Reset signal (RST#) is asserted, the 82540EP will not drive any PCI output or bi-directional pins except the Power Management Event signal (PME#).

3.2.1 PCI Address, Data and Control Signals

Symbol	Type	Name and Function
AD[31:0]	TS	Address and Data. Address and data signals are multiplexed on the same PCI pins. A bus transaction includes an address phase followed by one or more data phases. The address phase is the clock cycle when the Frame signal (FRAME#) is asserted low. During the address phase AD[31:0] contain a physical address (32 bits). For I/O, this is a byte address, and for configuration and memory, a DWORD address. The 82540EP device uses little endian byte ordering. During data phases, AD[7:0] contain the least significant byte (LSB) and AD[31:24] contain the most significant byte (MSB).



Symbol	Type	Name and Function
C/BE#[3:0]	TS	<p>Bus Command and Byte Enables. Bus command and byte enable signals are multiplexed on the same PCI pins. During the address phase of a transaction, C/BE#[3:0] define the bus command. In the data phase, C/BE#[3:0] are used as byte enables. The byte enables are valid for the entire data phase and determine which byte lanes contain meaningful data.</p> <p>C/BE#[0] applies to byte 0 (LSB) and C/BE#[3] applies to byte 3 (MSB).</p>
PAR	TS	<p>Parity. The Parity signal is issued to implement even parity across AD[31:0] and C/BE#[3:0]. PAR is stable and valid one clock after the address phase. During data phases, PAR is stable and valid one clock after either IRDY# is asserted on a write transaction or TRDY# is asserted after a read transaction. Once PAR is valid, it remains valid until one clock after the completion of the current data phase.</p> <p>When the 82540EP controller is a bus master, it drives PAR for address and write data phases, and as a slave device, drives PAR for read data phases.</p>
FRAME#	STS	<p>Cycle Frame. The Frame signal is driven by the 82540EP device to indicate the beginning and length of an access and indicate the beginning of a bus transaction. While FRAME# is asserted, data transfers continue. FRAME# is de-asserted when the transaction is in the final data phase.</p>
IRDY#	STS	<p>Initiator Ready. Initiator Ready indicates the ability of the 82540EP controller (as bus master device) to complete the current data phase of the transaction. IRDY# is used in conjunction with the Target Ready signal (TRDY#). The data phase is completed on any clock when both IRDY# and TRDY# are asserted.</p> <p>During the write cycle, IRDY# indicates that valid data is present on AD[31:0]. For a read cycle, it indicates the master is ready to accept data. Wait cycles are inserted until both IRDY# and TRDY# are asserted together. The 82540EP controller drives IRDY# when acting as a master and samples it when acting as a slave.</p>
TRDY#	STS	<p>Target Ready. The Target Ready signal indicates the ability of the 82540EP controller (as a selected device) to complete the current data phase of the transaction. TRDY# is used in conjunction with the Initiator Ready signal (IRDY#). A data phase is completed on any clock when both TRDY# and IRDY# are sampled asserted.</p> <p>During a read cycle, TRDY# indicates that valid data is present on AD[31:0]. For a write cycle, it indicates the target is ready to accept data. Wait cycles are inserted until both IRDY# and TRDY# are asserted together. The 82540EP device drives TRDY# when acting as a slave and samples it when acting as a master.</p>
STOP#	STS	<p>Stop. The Stop signal indicates the current target is requesting the master to stop the current transaction. As a slave, the 82540EP controller drives STOP# to request the bus master to stop the transaction. As a master, the 82540EP controller receives STOP# from the slave to stop the current transaction.</p>
IDSEL#	I	<p>Initialization Device Select. The Initialization Device Select signal is used by the 82540EP as a chip select signal during configuration read and write transactions.</p>
DEVSEL#	STS	<p>Device Select. When the Device Select signal is actively driven by the 82540EP, it signals notifies the bus master that it has decoded its address as the target of the current access. As an input, DEVSEL# indicates whether any device on the bus has been selected.</p>
VIO	P	<p>VIO. The VIO signal is a voltage reference for the PCI interface (3.3 V or 5 V PCI signaling environment). It is used as the clamping voltage.</p> <p>Note: An external resistor is required between the voltage reference and the VIO pin. The target resistor value is 100 K Ω.</p>



3.2.2 Arbitration Signals

Symbol	Type	Name and Function
REQ#	TS	Request Bus. The Request Bus signal is used to request control of the bus from the arbiter. This signal is point-to-point.
GNT#	I	Grant Bus. The Grant Bus signal notifies the 82540EP that bus access has been granted. This is a point-to-point signal.
LOCK#	I	Lock Bus. The Lock Bus signal is asserted by an initiator to require sole access to a target memory device during two or more separate transfers. The 82540EP device does not implement bus locking.

3.2.3 Interrupt Signal

Symbol	Type	Name and Function
INTA#	TS	Interrupt A. Interrupt A is used to request an interrupt by port 1 of the 82540EP. It is an active low, level-triggered interrupt signal.

3.2.4 System Signals

Symbol	Type	Name and Function
CLK	I	PCI Clock. The PCI Clock signal provides timing for all transactions on the PCI bus and is an input to the 82540EP device. All other PCI signals, except the Interrupt A (INTA#) and PCI Reset signal (RST#), are sampled on the rising edge of CLK. All other timing parameters are defined with respect to this edge.
M66EN	I	66 MHz Enable. M66EN indicates whether the system bus is enabled for 66 MHz.
RST#	I	PCI Reset. When the PCI Reset signal is asserted, all PCI output signals, except the Power Management Event signal (PME#), are floated and all input signals are ignored. The PME# context is preserved, depending on power management settings. Most of the internal state of the 82540EP is reset on the de-assertion (rising edge) of RST#.
CLK_RUN#	I/O OD	Clock Run. This signal is used by the system to pause the PCI clock signal. It is used by the 82540EP controller to request the PCI clock. When the CLK_RUN# feature is disabled, leave this pin unconnected.

3.2.5 Error Reporting Signals

Symbol	Type	Name and Function
SERR#	OD	System Error. The System Error signal is used by the 82540EP controller to report address parity errors. SERR# is open drain and is actively driven for a single PCI clock when reporting the error.
PERR#	STS	Parity Error. The Parity Error signal is used by the 82540EP controller to report data parity errors during all PCI transactions except by a Special Cycle. PERR# is sustained tri-state and must be driven active by the 82540EP controller two data clocks after a data parity error is detected. The minimum duration of PERR# is one clock for each data phase a data parity error is present.



3.2.6 Power Management Signals

Symbol	Type	Name and Function
LAN_PWR_GOOD	I	Power Good (Power-on Reset). The Power Good signal is used to indicate that stable power is available for the 82540EP. When the signal is low, the 82540EP holds itself in reset state and floats all PCI signals.
PME#	OD	Power Management Event. The 82540EP device drives this signal low when it receives a wake-up event and either the PME Enable bit in the Power Management Control/Status Register or the Advanced Power Management Enable (APME) bit of the Wake-up Control Register (WUC) is 1b.
AUX_PWR	I	Auxiliary Power. If the Auxiliary Power signal is high, then auxiliary power is available and the 82540EP device should support the D3cold power state.

3.2.7 Impedance Compensation Signals

Symbol	Type	Name and Function
ZN_COMP	I/O	N Device Impedance Compensation. This signal should be connected to an external precision resistor (to VDD) that is indicative of the PCI trace load. This cell is used to dynamically determine the drive strength required on the N-channel transistors in the PCI I/O cells.
ZP_COMP	I/O	P Device Impedance Compensation. This signal should be connected to an external precision resistor (to VSS) that is indicative of the PCI trace load. This cell is used to dynamically determine the drive strength required on the P-channel transistors in the PCI I/O cells.

3.2.8 SMB Signals

Symbol	Type	Name and Function
SMBCLK	I/O	SMB Clock. The SMB Clock signal is an open drain signal for serial SMB interface.
SMBDATA	I/O	SMB Data. The SMB Data signal is an open drain signal for serial SMB interface.
SMB_ALERT#	O	SMB Alert. The SMB Alert signal is open drain for serial SMB interface.

3.3 EEPROM and Serial FLASH Interface Signals

Symbol	Type	Name and Function
EEDI	O	EEPROM Data Input. The EEPROM Data Input pin is used for output to the memory device.
EEDO	I	EEPROM Data Output. The EEPROM Data Output pin is used for input from the memory device. The EE_DO includes an internal pull-up resistor.
EECS	O	EEPROM Chip Select. The EEPROM Chip Select signal is used to enable the device.
EESK	O	EEPROM Serial Clock. The EEPROM Shift Clock provides the clock rate for the EEPROM interface, which is approximately 1 MHz.



Symbol	Type	Name and Function
FL_CE#	O	FLASH Chip Enable Output. Used to enable FLASH device.
FL_SCK	O	FLASH Serial Clock Output. The clock rate of the serial FLASH interface is approximately 1 MHz.
FL_SI	O	FLASH Serial Data Input. This pin is an output to the memory device.
FLSH_SO	I	FLASH Serial Data Output. This pin is an input from the FLASH memory. Note: The 82540EP LAN-disable mechanism is implemented using this pin. It is generally used when no Flash device is present (Flash disabled). If this pin is 1b (Vcc) then the 82540EP is enabled. If the pin is 0b (Vss) then the 82540EP is disabled. This signal should be sampled within 1µs of the rising edge of LAN_PWR_GOOD and PCI_RST_N. Note that this pin also has an internal pull-up that is sufficient enough to enable the 82540EP if no Flash device is present.

Note: If the LAN-disable feature is used when a Flash device is present, then care must be taken by system designers not to drive the FLSH_SO pin while the Flash device is driving it.

3.4 Miscellaneous Signals

3.4.1 LED Signals

Symbol	Type	Name and Function
LINK_UP#	O	LED0 / LINK Up. Programmable LED indication. Defaults to indicate link connectivity.
ACTIVITY#	O	LED1 / Activity. Programmable LED indication. Defaults to flash to indicate transmit or receive activity.
LINK100#	O	LED2 / LINK 100. Programmable LED indication. Defaults to indicate link at 100 Mbps.
LINK1000#	O	LED3 / LINK 1000. Programmable LED indication. Defaults to indicate link at 1000 Mbps.

3.4.2 Other Signals

Symbol	Type	Name and Function
SDP[7:6] SDP[1:0]	TS	Software Defined Pins. The Software Defined Pins are reserved and programmable with respect to input and output capability. These default to input signals upon power-up but may be configured differently by the EEPROM. The upper four bits may be mapped to the General Purpose Interrupt bits if they are configured as input signals. Note: SDP5 is not included in the group of Software Defined Pins.



3.5 PHY Signals

3.5.1 Crystal Signals

Symbol	Type	Name and Function
XTAL1	I	Crystal One. The Crystal One pin is a 25 MHz +/- 30 ppm input signal. It can be connected to either an oscillator or crystal. If a crystal is used, Crystal Two (XTAL2) must also be connected.
XTAL2	O	Crystal Two. Crystal Two is the output of an internal oscillator circuit used to drive a crystal into oscillation. If an external oscillator is used in the design, XTAL2 must be disconnected.

3.5.2 Analog Signals

Symbol	Type	Name and Function
REF	P	Reference. This Reference signal should be connected to VSS through an external 2.49 K Ω resistor.
MDI[0]+/-	A	Media Dependent Interface [0]. 100BASE-T: In MDI configuration, MDI[0]+/- corresponds to BI_DA+/-, and in MDI-X configuration, MDI[0]+/- corresponds to BI_DB+/-. 100BASE-TX: In MDI configuration, MDI[0]+/- is used for the transmit pair, and in MDI-X configuration, MDI[0]+/- is used for the receive pair. 10BASE-T: In MDI configuration, MDI[0]+/- is used for the transmit pair, and in MDI-X configuration, MDI[0]+/- is used for the receive pair.
MDI[1]+/-	A	Media Dependent Interface [1]. 100BASE-T: In MDI configuration, MDI[1]+/- corresponds to BI_DB+/-, and in MDI-X configuration, MDI[1]+/- corresponds to BI_DA+/-. 100BASE-TX: In MDI configuration, MDI[1]+/- is used for the receive pair, and in MDI-X configuration, MDI[1]+/- is used for the transmit pair. 10BASE-T: In MDI configuration, MDI[1]+/- is used for the receive pair, and in MDI-X configuration, MDI[1]+/- is used for the transmit pair.
MDI[2]+/-	A	Media Dependent Interface [2]. 100BASE-T: In MDI configuration, MDI[2]+/- corresponds to BI_DC+/-, and in MDI-X configuration, MDI[2]+/- corresponds to BI_DD+/-. 100BASE-TX: Unused. 10BASE-T: Unused.
MDI[3]+/-	A	Media Dependent Interface [3]. 100BASE-T: In MDI configuration, MDI[3]+/- corresponds to BI_DD+/-, and in MDI-X configuration, MDI[3]+/- corresponds to BI_DC+/-. 100BASE-TX: Unused. 10BASE-T: Unused.



3.6 Test Interface Signals

Symbol	Type	Name and Function
JTAG_TCK	I	JTAG Clock.
JTAG_TDI	I	JTAG TDI.
JTAG_TDO	O	JTAG TDO.
JTAG_TMS	I	JTAG TMS.
JTAG_TRST#	I	JTAG Reset. This is an active low reset signal for JTAG. This signal should be terminated using a pull-down resistor to ground. It must not be left unconnected.
TEST	I	Factory Test Pin.
CLK_VIEW	O	Clock View. Output for GTX_CLK and RX_CLK during IEEE PHY conformance testing. The clock is selected by register programming.
ALTCLK_125	I	Alternate CLK125 Input. Factory use only. For normal component operation, connect to VSS.
CLK_BYP#	I	Clock Bypass Enable. Factory use only. For normal component operation, no connect.
HSDACP	I	PHY High Speed Test Interface. Factory use only. For normal component operation, no connect.
HSDACN	I	PHY High Speed Test Interface. Factory use only. For normal component operation, no connect.
PHY_TSTPT	I	PHY Test Point. Factory use only. For normal component operation, no connect.

3.7 Power Supply Connections

3.7.1 Digital Supplies

Symbol	Type	Name and Function
VDDO	P	3.3 V I/O Power Supply.
DVDD	P	1.5 V Digital Core Power Supply.

3.7.2 Analog Supplies

Symbol	Type	Name and Function
AVDDH	P	3.3 V Analog Power Supply.
AVDDL	P	2.5 V Analog Power Supply.



3.7.3 Ground and No Connects

Symbol	Type	Name and Function
GND	P	Ground.
NC	P	No Connect. Do not connect any circuitry to these pins. Pull-up or pull-down resistors should not be connected to these pins.

3.7.4 Control Signals

Symbol	Type	Name and Function
CTRL15	A	1.5V Control. LDO voltage regulator output to drive external pass transistor. If 1.5 V is already present in the system, leave output unconnected. To achieve optimal D ₃ power consumption (<50 mw), leave the output unconnected and use a high-efficiency external switching regulator.
CTRL25	A	2.5V Control. LDO voltage regulator output to drive external pass transistor. If 2.5 V is already present in the system, leave output unconnected. To achieve optimal D ₃ power consumption (<50 mw), leave the output unconnected and use a high-efficiency external switching regulator.

4.0 Voltage, Temperature, and Timing Specifications

Note: The specification values listed in this section are subject to change without notice. Verify with your local Intel sales office that you have the latest information before finalizing a design.

4.1 Absolute Maximum Ratings

Table 1. Absolute Maximum Ratings^a

Symbol	Parameter	Min	Max	Unit
V_{DD}	DC supply voltage	-0.3	7	V
V_{IN}	Input voltage	-1	$V_{DD} + 0.3$	V
I_{IN}	DC input pin current	-10	10	mA
T_{STG}	Storage temperature	-40	125	°C

a. Maximum ratings are referenced to ground (VSS). Permanent device damage is likely to occur if the ratings in this table are exceeded. These values should not be used as the limits for normal device operations.

4.2 Recommended Operating Conditions

Table 2. Recommended Operating Conditions^a (Sheet 1 of 2)

Symbol	Parameter	Condition	Min	Typ	Max	Unit
T_{OP}	Operating Temperature		-40		85	°C
V_{IO}	VIO Voltage Range		3		5.25	V
V_{DD}	Periphery Voltage Range	3.3 V \pm 10%	3	3.3	3.6	V

Table 2. Recommended Operating Conditions^a (Sheet 2 of 2)

Symbol	Parameter	Condition	Min	Typ	Max	Unit
V _{AH}	Analog High VDD Range	3.3 V ± 10%	3	3.3	3.6	V
V _D	Core Digital Voltage Range	1.5 V ± 5%	1.425	1.5	1.575	V
V _{AL}	Analog Low VDD Range	2.5 V ± 5%	2.375	2.5	2.625	V

a. Sustained operation of the device at conditions exceeding these values, even if they are within the absolute maximum rating limits, might result in permanent damage.

4.3 DC Specifications

Table 3. DC Characteristics

Symbol	Parameter	Min	Typ	Max	Units
V _{DD} (3.3)	DC supply voltage on VD00 or AVDDH	3.00	3.3	3.60	V
V _{DD} (2.5)	DC supply voltage on AVDDL	2.38	2.5	2.62	V
V _{DD} (1.5)	DC supply voltage on DVDD	1.43	1.5	1.57	V

Table 4. Power Specifications - D0a

	D0a							
	unplugged/no link		@10 Mbps		@100Mbps		@1000Mbps	
	Typ I _{cc} (mA)	Max I _{cc} (mA)	Typ I _{cc} (mA)	Max I _{cc} (mA)	Typ I _{cc} (mA)	Max I _{cc} (mA)	Typ I _{cc} (mA)	Max I _{cc} (mA)
3.3 V	40	40	55	65	65	80	125	125
2.5 V	20	20	30	35	55	60	145	150
1.5 V	100	120	95	100	115	125	400	425
Total Device Power	325 mW		400 mW		525 mW		1.38 W	1.5 W



Table 5. Power Specifications - D3cold

	D3cold - wake-up enabled						D3cold - wake disabled - max power savings mode disabled		D3cold - wake disabled - max power savings mode enabled ^a	
	unplugged/no link		@10 Mbps		@100Mbps		Typ lcc (mA)	Maxlcc (mA)	Typ lcc (mA)	Maxlcc (mA)
	Typlcc (mA)	Maxlcc (mA)	Typlcc (mA)	Maxlcc (mA)	Typ lcc (mA)	Maxlcc (mA)				
3.3 V	40	40	55	55	50	50	40	40	6	8
2.5 V	20	20	30	30	55	55	20	20	0.1	0.1
1.5 V	40	40	30	35	55	60	10	10	1	1
Total Device Power	240 mW		300 mW		385 mW		195 mW		20 mW	

a. Special Note: To obtain the benefit of max power savings mode, do not use the internal voltage regulator control circuit and external pass transistors. Use external switching regulators for highest efficiency.

Table 6. Power Specifications D(r) Uninitialized

	D(r) Uninitialized (LAN_PWR_GOOD=0)	
	Typ lcc (mA)	Max lcc (mA)
3.3 V	40	45
2.5 V	40	45
1.5 V	190	200
Total Device Power	520 mW	

Table 7. Power Specifications - Complete Subsystem

	Complete Subsystem (Reference Design) Including Magnetics, LED, Regulator Circuits									
	D3cold - wake disabled - max power savings mode disabled		D3cold wake-enabled @10Mbps		D3cold wake-enabled @100Mbps		D0 @1000Mbps active		D3cold - wake disabled - max power savings mode enabled	
	Typlcc (mA)	Maxlcc (mA)	Typlcc (mA)	Maxlcc (mA)	Typlcc (mA)	Maxlcc (mA)	Typ lcc (mA)	Max lcc (mA)	Typlcc (mA)	Maxlcc (mA)
3.3 V	40	40	60	60	60	60	130	130	6	8



Table 7. Power Specifications - Complete Subsystem

2.5 V	20	20	40	40	80	80	240	245	0.1	0.1
1.5 V	10	10	30	35	55	60	400	425	1	1
Subsystem 3.3 V current		70 mA		135 mA		200 mA		800 mA		10 mA

Table 8. I/O Characteristics

Symbol	Parameter	Condition	Min	Typ	Max	Unit
V_{IL}	Voltage input LOW		-0.5		0.8	V
V_{IH}	Voltage input HIGH		2		$V_{DD} + 0.3$	V
V_{OL}	Voltage output LOW				0.4	V
V_{OH}	Voltage output HIGH		2.4			V
V_{SH}	Schmitt Trigger Hysteresis		0.1			V
I_{OL}^a	Output current LOW 3mA drivers (TTL3) 6mA drivers (TTL6) 12mA drivers (TTL12)	V_{OL}	3			mA
		V_{OL}	6			mA
		V_{OL}	12			mA
I_{OH}^a	Output current HIGH 3mA drivers (TTL3) 6mA drivers (TTL6) 12mA drivers (TTL12)	V_{OH}	-3			mA
		V_{OH}	-6			mA
		V_{OH}	-12			mA
I_{IN}	Input Current TTL inputs Inputs with pull-down resistors TTL inputs with pull-up resistors	$V_{IN} = V_{DD}$ or V_{SS}	-10	± 1	10	μA
		$V_{IN} = V_{DD}$	150		480	μA
		$V_{IN} = V_{SS}$	-150		-480	μA
I_{OZ}	3-state output leakage current	$V_{OH} = V_{DD}$ or V_{SS}	-10	± 1	10	μA
C_{IN}	Input capacitance	Any input and bi-directional buffer		2.5		pF
C_{OUT}	Output capacitance	Any output buffer		2		pF
C_{PUD}	Pull-up/down Resistor value		15	20	30	k Ω

- a. TTL3 signals include: EE_DI, EE_SK, EE_CS, and JTAG_TDO.
TTL6 signals include: CLKRUN#, FL_CE#, FL_SCK, FL_SI, and CLK_VIEW.
TTL12 signals include: LED0 / LINK #, LED1 / ACT #, LED2 / LINK100 #, LED3 / LINK1000 #, SDP0, SDP1, SDP6, and SDP7.

4.4 AC Characteristics

Table 9. AC Characteristics: 3.3 V Interfacing

Symbol	Parameter	Min	Typ	Max	Unit
CLK	Clock frequency in PCI mode			66	MHz

Table 10. 25 MHz Clock Input Requirements

Symbol	Parameter ^a	Min	Typ	Max	Unit
fi_TX_CLK	TX_CLK_IN frequency	25 - 50 ppm	25	25 + 50 ppm	MHz

a. This parameter applies to an oscillator connected to the Crystal One (XTAL1) input. Alternatively, a crystal may be connected to XTAL1 and XTAL2 as the frequency source for the internal oscillator.

Table 11. Link Interface Clock Requirements

Symbol	Parameter	Min	Typ	Max	Unit
fGTX ^a	GTX_CLK frequency		125		MHz

a. GTX_CLK is used externally for test purposes only.

Table 12. EEPROM Interface Clock Requirements

Symbol	Parameter	Min	Typ	Max	Unit
fSK				1	MHz

Table 13. AC Test Loads for General Output Pins

Symbol	Signal Name	Value	Units
CL	TDO	10	pF
CL	PME#, SDP[7:0]	16	pF
CL	EEDI, EESK	18	pF
CL	RX_ACTIVITY, TX_ACTIVITY, LINK_UP	20	pF

Figure 1. AC Test Loads for General Output Pins

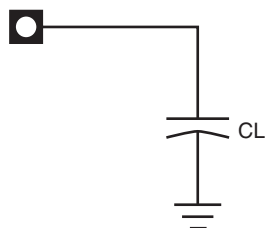

4.5 Timing Specifications

Note: Timing specifications are subject to change. Verify with your local Intel sales office that you have the latest information before finalizing a design.

4.5.1 PCI Bus Interface

4.5.1.1 PCI Bus Interface Clock

Table 14. PCI Bus Interface Clock Parameters

Symbol	Parameter ^a	PCI 66 MHz		PCI 33 MHz		Units
		Min	Max	Min	Max	
TCYC	CLK cycle time	15	30	30		ns
TH	CLK high time	6		11		ns
TL	CLK low time	6		11		ns
	CLK slew rate	1.5	4	1	4	V/ns
	RST# slew rate ^b	50		50		mV/ns

a. Rise and fall times are specified in terms of the edge rate measured in V/ns. This slew rate must be met across the minimum peak-to-peak portion of the clock waveform as shown.

b. The minimum RST# slew rate applies only to the rising (de-assertion) edge of the reset signal and ensures that system noise cannot render a monotonic signal to appear bouncing in the switching range.

Figure 2. PCI Clock Timing

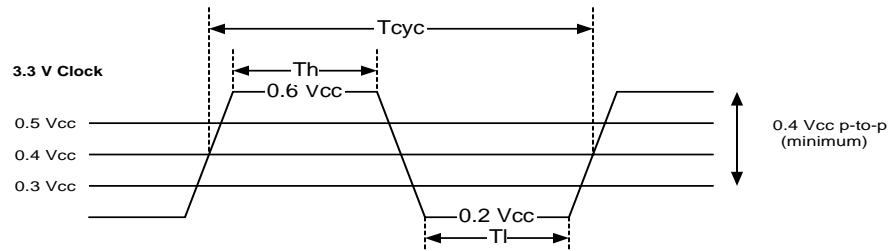

4.5.1.2 PCI Bus Interface Timing

Table 15. PCI Bus Interface Timing Parameters

Symbol	Parameter	PCI 66MHz		PCI 33 MHz		Units
		Min	Max	Min	Max	
TVAL	CLK to signal valid delay: bussed signals	2	6	2	11	ns
TVAL(ptp)	CLK to signal valid delay: point-to-point signals	2	6	2	12	ns
TON	Float to active delay	2		2		ns
TOFF	Active to float delay		14		28	ns
TSU	Input setup time to CLK: bussed signals	3		7		ns
TSU(ptp)	Input setup time to CLK: point-to-point signals	5		10, 12		ns
TH	Input hold time from CLK	0		0		ns
TRRSU	REQ64# to RST# setup time	10*TCYC		10*TCYC		ns
TRRH	RST# to REQ64# hold time	0		0		ns

NOTES:

1. Output timing measurements are as shown.
2. REQ# and GNT# signals are point-to-point and have different output valid delay and input setup times than bussed signals. GNT# has a setup of 10 ns; REQ# has a setup of 12 ns. All other signals are bussed.
3. Input timing measurements are as shown.



Figure 3. PCI Bus Interface Output Timing Measurement

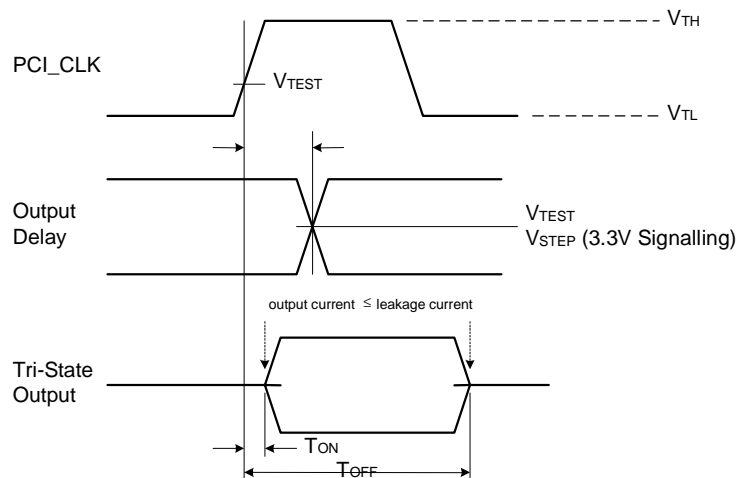

Figure 4. PCI Bus Interface Input Timing Measurement Conditions

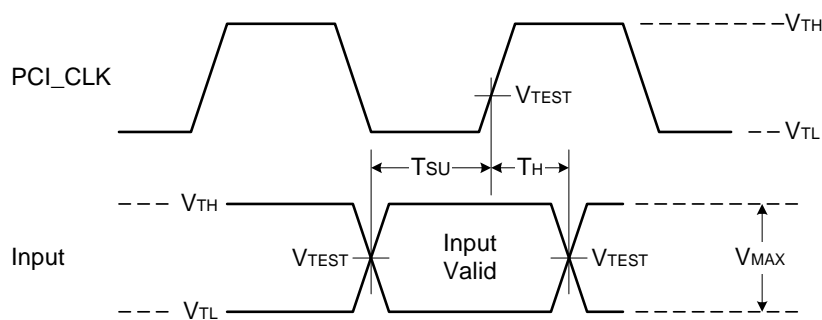

Table 16. PCI Bus Interface Timing Measurement Conditions

Symbol	Parameter	PCI 66 MHz 3.3 v	Unit
VTH	Input measurement test voltage (high)	0.6*VCC	V
VTL	Input measurement test voltage (low)	0.2*VCC	V
VTEST	Output measurement test voltage	0.4*VCC	V
	Input signal slew rate	1.5	V/ns

Figure 5. TVAL (max) Rising Edge Test Load

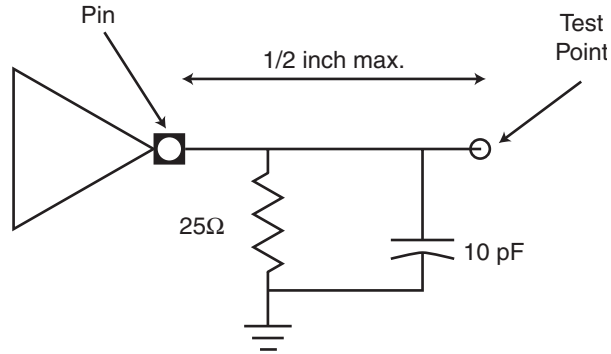

Figure 6. TVAL (max) Falling Edge Test Load

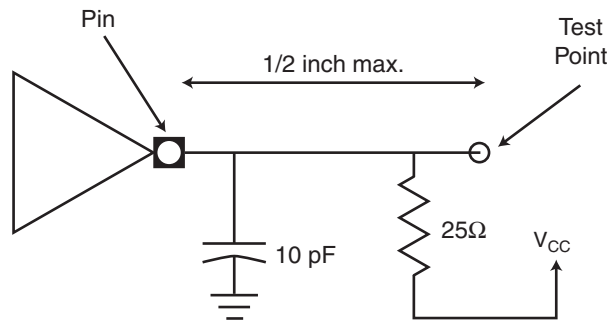

Figure 7. TVAL (min) Test Load

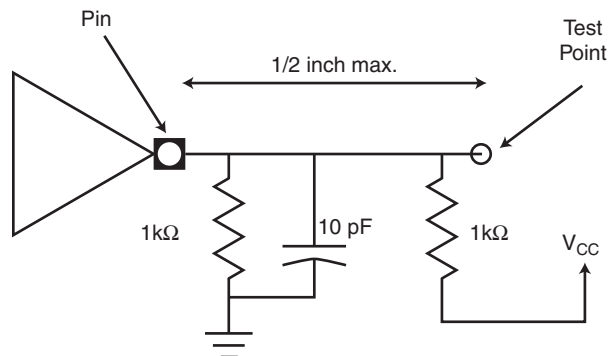
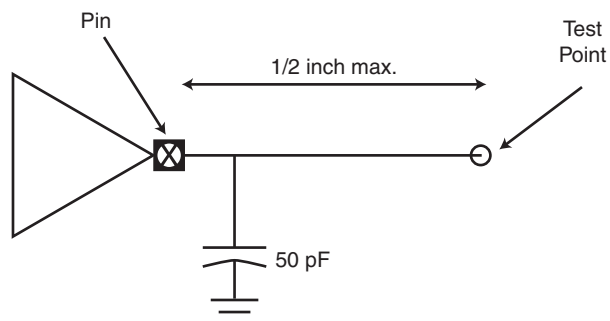

Figure 8. TVAL Test Load (PCI 5 V Signaling Environment)



NOTE: Note: 50 pF load used for maximum times. Minimum times are specified with 0 pF load.

4.5.2 Link Interface Timing

Table 17. Rise and Fall Times

Symbol	Parameter	Condition	Min	Max	Unit
TR	Clock rise time	0.8 V to 2.0 V	0.7		ns
TF	Clock fall time	2.0 V to 0.8 V	0.7		ns
TR	Data rise time	0.8 to 2.0 V	0.7		ns
TF	Data fall time	2.0 V to 0.8 V	0.7		ns

Figure 9. Link Interface Rise/Fall Timing

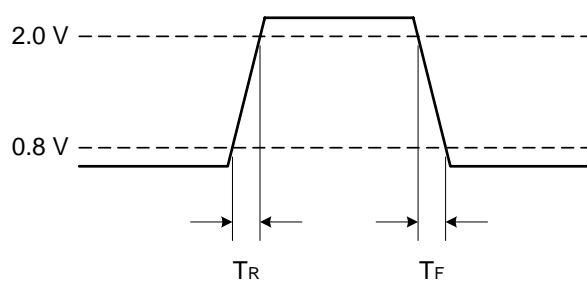



4.5.3 EEPROM Interface

Table 18. Link Interface Clock Requirements

Symbol	Parameter	Min	Typ	Max	Unit
TPW	EESK pulse width		TPERIOD*128		ns

a. The EEPROM clock is derived from a 125 MHz internal clock.

Table 19. Link Interface Clock Requirements

Symbol	Parameter ^a	Min	Typ	Max	Unit
TDOS	EEDO setup time	TCYC*2			ns
TDOH	EEDO hold time	0			ns

a. The EEDO setup and hold time is a function of the PCI bus CLK cycle time but is referenced to EESK.



Note: This page intentionally left blank.

5.0 Package and Pinout Information

This section describes the 82540EP device, manufactured in a 196-lead ball grid array measuring 15mm x 15mm. External product identification is shown in Figure 10. The nominal ball pitch is 1mm. The pin number-to-signal mapping is indicated beginning with Table 19.

5.1 Device Identification

Figure 10. 82540EP Device Identification Markings

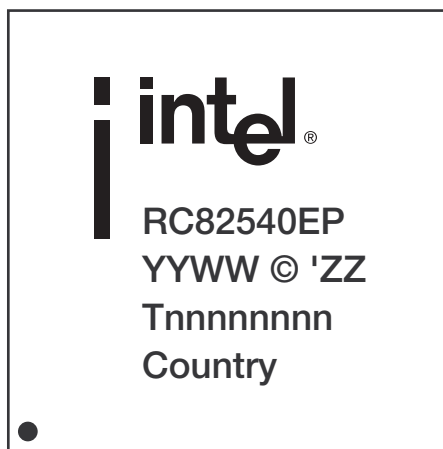

82540EP	Product Name
YYWW	Date Code
Tnnnnnnnn	Lot Trace Code
(c)'ZZ	Copyright Information
Country	Country of Origin Assembly

NOTE: “●” indicates the location of pin 1. It is not an actual mark on the device



5.3 Thermal Specifications

The 82540EP device is specified for operation when the ambient temperature (TA) is within the range of -40° C to 85° C.

TC (case temperature) is calculated using the equation:

$$TC = TA + P (\theta JA - q JC)$$

TJ (junction temperature) is calculated using the equation:

$$TJ = TA + P \theta JA$$

P (power consumption) is calculated by using the typical ICC, as indicated in Table 4 of Section 4.0, and nominal VCC. The thermal resistances are shown in Table 18.

Table 18. Thermal Characteristics

Symbol	Parameter	Value at specified airflow (m/s)				Units
		0	1	2	3	
θJA	Thermal resistance, junction-to-ambient	28.1	25.0	23.7	22.8	°C/ Watt
θJC	Thermal resistance, junction-to-case	6.1	6.1	6.1	6.1	°C/ Watt

Thermal resistances are determined empirically with test devices mounted on standard thermal test boards. Real system designs may have different characteristics due to board thickness, arrangement of ground planes, and proximity of other components. The case temperature measurements should be used to assure that the 82540EP device is operating under recommended conditions.



5.4 Pinout Information

Table 19. PCI Address, Data, and Control Signals

Signal	Pin	Signal	Pin	Signal	Pin
AD[0]	N7	AD[16]	K1	C/BE#[0]	M4
AD[1]	M7	AD[17]	E3	C/BE#[1]	L3
AD[2]	P6	AD[18]	D1	C/BE#[2]	F3
AD[3]	P5	AD[19]	D2	C/BE#[3]	C4
AD[4]	N5	AD[20]	D3	PAR	J1
AD[5]	M5	AD[21]	C1	FRAME#	F2
AD[6]	P4	AD[22]	B1	IRDY#	F1
AD[7]	N4	AD[23]	B2	TRDY#	G3
AD[8]	P3	AD[24]	B4	STOP#	H1
AD[9]	N3	AD[25]	A5	DEVSEL#	H3
AD[10]	N2	AD[26]	B5	VIO	G2
AD[11]	M1	AD[27]	B6	IDSEL	A4
AD[12]	M2	AD[28]	C6		
AD[13]	M3	AD[29]	C7		
AD[14]	L1	AD[30]	A8		
AD[15]	L2	AD[31]	B8		

Table 20. PCI Arbitration Signals

Signal	Pin
REQ#	C3
GNT#	J3

Table 21. Interrupt Signals

Signal	Pin
INTA#	H2

Table 22. System Signals

Signal	Pin	Signal	Pin	Signal	Pin
CLK	G1	M66EN	C2	RST#	B9

Table 23. Error Reporting Signals

Signal	Pin	Signal	Pin
SERR#	A2	PERR#	J2

**Table 24. Power Management Signals**

Signal	Pin	Signal	Pin
LAN_PWR_GOOD	A9	AUX_PWR	J12
PME#	A6	CLK_RUN#	C8

Table 25. Impedance Compensation Signals

Signal	Pin	Signal	Pin
ZN_COMP	H4	ZP_COMP	G4

Table 26. SMB Signals

Signal	Pin	Signal	Pin	Signal	Pin
SMBCLK	A10	SMBDATA	C9	SMB_ALERT#	B10

Table 27. EEPROM and Serial FLASH Interface Signals

Signal	Pin	Signal	Pin	Signal	Pin
EESK	M10	EEDI	P10	FL_SCK	N9
EEDO	N10	FL_CE#	M9	FLSH_SO	P9
EECS	P7	FL_SI	M11		

Table 28. LED Signals

Signal	Pin	Signal	Pin
LINK_UP#	A12	LINK100#	B11
ACTIVITY#	C11	LINK1000#	B12

Table 29. Other Signals

Signal	Pin	Signal	Pin	Signal	Pin
SDP[0]	N14	SDP[6]	N13	CTRL15	P11
SDP[1]	P13	SDP[7]	M12	CTRL25	B13

Table 30. IEEE Test Signals

Signal	Pin
CLK_VIEW	M8



Table 31. PHY Signals

Signal	Pin	Signal	Pin	Signal	Pin
XTAL1	K14	MDI[0]+	C13	MDI[2]+	F13
XTAL2	J14	MDI[1]-	E14	MDI[3]-	H14
REF	B14	MDI[1]+	E13	MDI[3]+	H13
MDI[0]-	C14	MDI[2]-	F14		

Table 32. Test Interface Signals

Signal	Pin	Signal	Pin	Signal	Pin
JTAG_TCK	L14	JTAG_TDO	M14	JTAG_RST#	L13
JTAG_TDI	M13	JTAG_TMS	L12	TEST	A13

Table 33. Digital Power Signals

Signal	Pin	Signal	Pin	Signal	Pin
DVDD (1.5V)	E11	DVDD (1.5V)	J8	DVDD (1.5V)	L9
DVDD (1.5V)	E12	DVDD (1.5V)	J9	DVDD (1.5V)	L10
DVDD (1.5V)	G5	DVDD (1.5V)	J10	VDDO (3.3V)	A3
DVDD (1.5V)	G6	DVDD (1.5V)	J11	VDDO (3.3V)	A7
DVDD (1.5V)	G13	DVDD (1.5V)	K5	VDDO (3.3V)	A11
DVDD (1.5V)	H5	DVDD (1.5V)	K6	VDDO (3.3V)	E1
DVDD (1.5V)	H6	DVDD (1.5V)	K7	VDDO (3.3V)	K3
DVDD (1.5V)	H7	DVDD (1.5V)	K8	VDDO (3.3V)	K4
DVDD (1.5V)	H8	DVDD (1.5V)	K9	VDDO (3.3V)	K13
DVDD (1.5V)	H11	DVDD (1.5V)	K10	VDDO (3.3V)	N6
DVDD (1.5V)	J5	DVDD (1.5V)	K11	VDDO (3.3V)	N8
DVDD (1.5V)	J6	DVDD (1.5V)	L4	VDDO (3.3V)	P2
DVDD (1.5V)	J7	DVDD (1.5V)	L5	VDDO (3.3V)	P12

Table 34. Analog Power Signals

Signal	Pin	Signal	Pin	Signal	Pin
AVDDL (2.5 V)	D9	AVDDL (2.5 V)	G12	AVDDL (2.5 V)	L8
AVDDL (2.5 V)	D11				

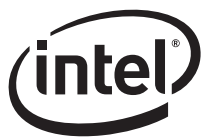

Table 35. Grounds and No Connect Signals

Signal	Pin	Signal	Pin	Signal	Pin	Signal	Pin
VSS	B3	VSS	E7	VSS	G9	NC	A1
VSS	B7	VSS	E8	VSS	G10	NC	A14
VSS	C10	VSS	E9	VSS	G11	NC	C5
VSS	C12	VSS	E10	VSS	G14	NC	D10
VSS	D4	VSS	F4	VSS	H9	NC	D12
VSS	D5	VSS	F5	VSS	H10	NC	D14
VSS	D6	VSS	F6	VSS	K2	NC	F12
VSS	D7	VSS	F7	VSS	K12	NC	H12
VSS	D8	VSS	F8	VSS	L6	NC	J4
VSS	D13	VSS	F9	VSS	L11	NC	J13
VSS	E2	VSS	F10	VSS	M6	NC	L7
VSS	E4	VSS	F11	VSS	N1	NC	N11
VSS	E5	VSS	G7	VSS	N12	NC	P1
VSS	E6	VSS	G8	VSS	P8	NC	P14

Table 36. Signal Names in Pin Order (Sheet 1 of 6)

Signal Name	Pin
NC	A1
SERR#	A2
3.3V	A3
IDSEL	A4
AD[25]	A5
PME#	A6
3.3V	A7
AD[30]	A8
LAN_PWR_GOOD	A9
SMBCLK	A10
3.3V	A11
LINK_UP#	A12
TEST	A13
NC	A14
AD[22]	B1
AD[23]	B2
VSS	B3
AD[24]	B4



Table 36. Signal Names in Pin Order (Sheet 2 of 6) (Continued)

Signal Name	Pin
AD[26]	B5
AD[27]	B6
VSS	B7
AD[31]	B8
RST#	B9
SMB_ALERT#	B10
LINK100#	B11
LINK1000#	B12
CTRL25	B13
PHY REF	B14
AD[21]	C1
M66EN	C2
REQ#	C3
C/BE#[3]	C4
NC	C5
AD[28]	C6
AD[29]	C7
CLK_RUN#	C8
SMBDATA	C9
VSS	C10
ACTIVITY#	C11
VSS	C12
MDI[0]+	C13
MDI[0]-	C14
AD[18]	D1
AD[19]	D2
AD[20]	D3
ALT_CLK125 (connect to VSS)	D4
VSS	D5
VSS	D6
VSS	D7
VSS	D8
2.5 V	D9
NC	D10
2.5 V	D11
NC	D12
VSS	D13
NC	D14



Table 36. Signal Names in Pin Order (Sheet 3 of 6) (Continued)

Signal Name	Pin
3.3V	E1
VSS	E2
AD[17]	E3
VSS	E4
VSS	E5
VSS	E6
VSS	E7
VSS	E8
VSS	E9
VSS	E10
1.5V	E11
1.5V	E12
MDI[1]+	E13
MDI[1]-	E14
IRDY#	F1
FRAME#	F2
C/BE#[2]	F3
VSS	F4
VSS	F5
VSS	F6
VSS	F7
VSS	F8
VSS	F9
VSS	F10
VSS	F11
PHY_TSTPT (do not connect)	F12
MDI[2]+	F13
MDI[2]-	F14
CLK	G1
VIO	G2
TRDY#	G3
ZP_COMP	G4
1.5V	G5
1.5V	G6
VSS	G7
VSS	G8
VSS	G9
VSS	G10



Table 36. Signal Names in Pin Order (Sheet 4 of 6) (Continued)

Signal Name	Pin
VSS	G11
2.5 V	G12
1.5V	G13
VSS	G14
STOP#	H1
INTA#	H2
DEVSEL#	H3
ZN_COMP	H4
1.5V	H5
1.5V	H6
1.5V	H7
1.5V	H8
VSS	H9
VSS	H10
1.5V	H11
HSDACN (do not connect)	H12
MDI3]+	H13
MDI[3]-	H14
PAR	J1
PERR#	J2
GNT#	J3
NC	J4
1.5V	J5
1.5V	J6
1.5V	J7
1.5V	J8
1.5V	J9
1.5V	J10
1.5V	J11
AUX_PWR	J12
HSDACP (do not connect)	J13
XTAL2	J14
AD[16]	K1
VSS	K2
3.3V	K3
3.3V	K4
1.5V	K5
1.5V	K6



Table 36. Signal Names in Pin Order (Sheet 5 of 6) (Continued)

Signal Name	Pin
1.5V	K7
1.5V	K8
1.5V	K9
1.5V	K10
1.5V	K11
AVSS	K12
3.3V	K13
XTAL1	K14
AD[14]	L1
AD[15]	L2
C/BE#[1]	L3
1.5V	L4
1.5V	L5
VSS	L6
CLK_BYP# (do not connect)	L7
2.5 V	L8
1.5V	L9
1.5V	L10
VSS	L11
JTAG_TMS	L12
JTAG_RST#	L13
JTAG_TCK	L14
AD[11]	M1
AD[12]	M2
AD[13]	M3
C/BE#[0]	M4
AD[5]	M5
VSS	M6
AD[1]	M7
CLK_VIEW	M8
FL_CE#	M9
EESK	M10
FL_SI	M11
SDP[7]	M12
JTAG_TDI	M13
JTAG_TDO	M14
VSS	N1
AD[10]	N2



Table 36. Signal Names in Pin Order (Sheet 6 of 6) (Continued)

Signal Name	Pin
AD[9]	N3
AD[7]	N4
AD[4]	N5
3.3V	N6
AD[0]	N7
3.3V	N8
FL_SCK	N9
EEDO	N10
NC	N11
VSS	N12
SDP[6]	N13
SDP[0]	N14
NC	P1
3.3V	P2
AD[8]	P3
AD[6]	P4
AD[3]	P5
AD[2]	P6
EECS	P7
GND	P8
FLSH_SO	P9
EEDI	P10
CTRL15	P11
3.3V	P12
SDP[1]	P13
NC	P14

5.5 Visual Pin Reference

	A	B	C	D	E	F	G	H	J	K	L	M	N	P
1	NC	AD[22]	AD[21]	AD[18]	3.3V	IRDY#	CLK	STOP#	PAR	AD[16]	AD[14]	AD[11]	VSS	NC
2	SERR#	AD[23]	M66EN	AD[19]	VSS	FRAME#	VIO	INTA#	PERR#	VSS	AD[15]	AD[12]	AD[10]	3.3V
3	3.3V	VSS	REQ#	AD[20]	AD[17]	C/BE#[2]	TRDY#	DVSEL#	GNT#	3.3V	C/B3#[1]	AD[13]	AD[9]	AD[8]
4	IDSEL	AD[24]	C/BE#[3]	ALT_CLK125	VSS	VSS	ZP_COMP	ZN_COMP	NC	3.3V	1.5V	C/BE#[0]	AD[7]	AD[6]
5	AD[25]	AD[26]	NC	VSS	VSS	VSS	1.5V	1.5V	1.5V	1.5V	1.5V	AD[5]	AD[4]	AD[3]
6	PME#	AD[27]	AD[28]	VSS	VSS	VSS	1.5V	1.5V	1.5V	1.5V	VSS	VSS	3.3V	AD[2]
7	3.3V	VSS	AD[29]	VSS	VSS	VSS	VSS	1.5V	1.5V	1.5V	CLK_BYP#	AD[1]	AD[0]	EECS
8	AD[30]	AD[31]	CLK_RUN#	VSS	VSS	VSS	VSS	1.5V	1.5V	1.5V	2.5V	CLK_VIEW	3.3V	VSS
9	LAN_PWR_GOOD	RST#	SMBDATA	2.5V	VSS	VSS	VSS	VSS	1.5V	1.5V	1.5V	FLSH_CE#	FLSH_SCK	FLSH_SO
10	SMBCLK	SMB_ALERT#	VSS	NC	VSS	VSS	VSS	VSS	1.5V	1.5V	1.5V	EESK	EEDO	EEDI
11	3.3V	LINK100#	ACTIVITY#	2.5V	1.5V	VSS	VSS	1.5V	1.5V	1.5V	VSS	FLSH_SI	NC	CTRL15
12	LINK_UP#	LINK1000#	VSS	NC	1.5V	PHY_TSTPT	2.5V	HSDACN	AUX_PWR	VSS	JTAG_TMS	SDP[7]	VSS	3.3V
13	TEST	CTRL25	MDI[0]+	VSS	MDI[1]+	MDI[2]+	1.5V	MDI[3]+	HSDACP	3.3V	JTAG_TRST#	JTAG_TDI	SDP[6]	SDP[1]
14	NC	PHY REF	MDI[0]-	NC	MDI[1]+	MDI[2]+	VSS	MDI[3]+	XTAL2	XTAL1	JTAG_TCK	JTAG_TDO	SDP[0]	NC

Figure 12. Ball Grid Array / Pin Reference for 196-TFBGA (Bottom/Pin View)

Note: Figure 12 is rotated 90 degrees counter-clockwise from the pin 1 position (corner) in Figure 11.



Note: This page is intentionally left blank.