

LVDS Dual 2x2 Crosspoint/Repeater Switch
Features

- Dual 2x2 Crosspoint/Repeater Switch
- Meets or Exceeds the Requirements of ANSI TIA/EIA-644-1995
- Designed for Signaling Rates up to 650 Mbit/s (325Mhz)
- Operates from a single 3.3V Supply: -40°C to 85°C
- Low-Voltage Differential Signaling with Output Voltages of $\pm 350\text{mV}$ into:
 - 100 Ω load (PI90LV044)
 - 50 Ω load Bus LVDS Signaling (PI90LVB044)
- Accepts $\pm 350\text{mV}$ differential inputs
- Wide common mode input range: 0.2V to 2.7V
- Output drivers are high impedance when disabled or when $V_{CC} \leq 1.5\text{V}$
- Inputs are open, short, and terminated fail safe
- Propagation Delay Time: 3.5ns
- ESD protection is 10kV on bus pins
- Bus Pins are High Impedance when disabled or with V_{CC} less than 1.5V
- TTL Inputs are 5V Tolerant
- Power Dissipation at 400 Mbit/s of 250mW
- Packaging (Pb-free & Green available):
 - 28-pin QSOP (Q)
 - 28-pin TSSOP (L)

Description

The PI90LV044 and PI90LVB044 are monolithic dual 2x2 asynchronous crosspoint/repeater switches. The crosspoint function is based on a multiplexer tree architecture. Each 2x2 switch can be considered as a pair of 2:1 multiplexers that share the same inputs. The signal path through each switch is fully differential with minimal propagation delay. The signal path is unregistered, so no clock is required for the data inputs. The signal line drivers and receivers use Low Voltage Differential Signaling (LVDS) to achieve signaling rates as high as 650Mbps.

The LVDS standard provides a minimum differential output voltage magnitude of 247 mV into a 100 Ω load and receipt of 100 mV signals with up to 1V of ground potential difference between a transmitter and receiver. The PI90LVB044 doubles the output drive current to achieve LVDS levels with a 50 ohm load.

The intended application of these devices is for loop-through and redundant channel switching for both point-to-point baseband (PI90LV044) and multipoint (PI90LVB044) data transmissions over controlled impedance media.

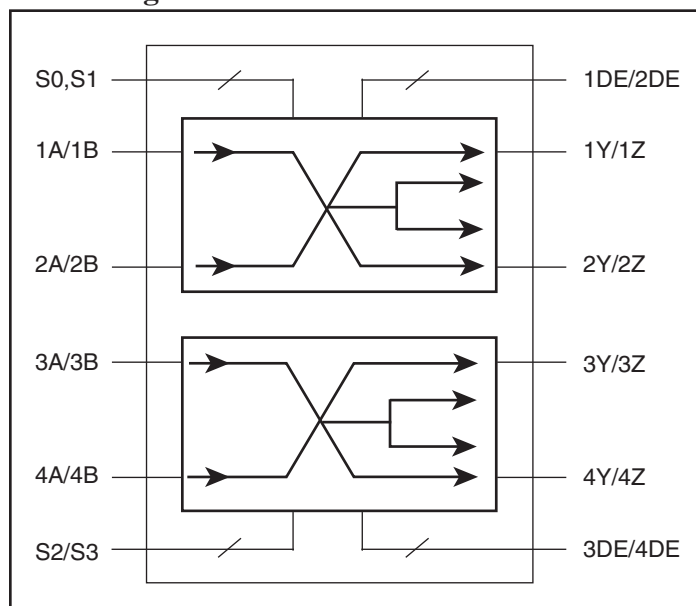
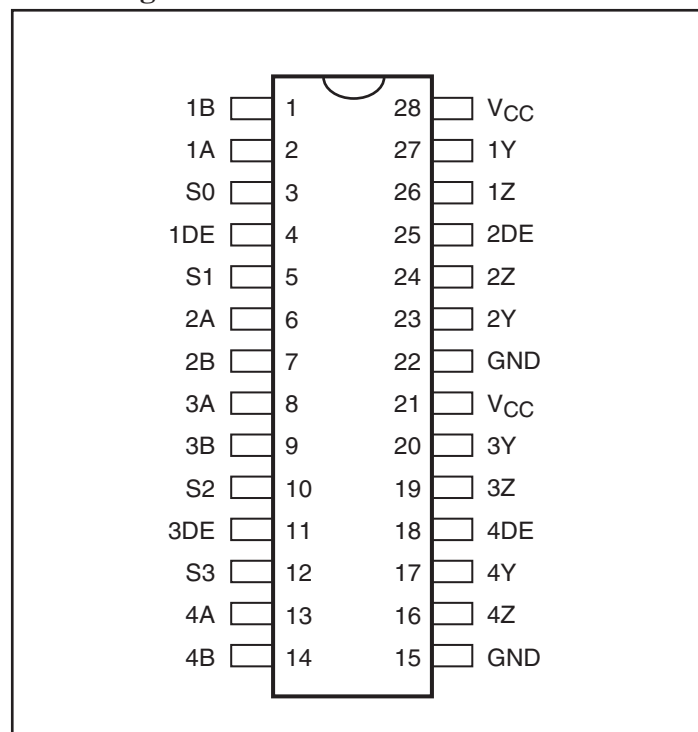
Block Diagram

Pin Configuration

MUX Truth Table

Input		Output		Function
S3, S1	S2, S0	1Y/1Z - 3Y/3Z	2Y/2Z - 4Y/4Z	
0	0	1A/1B - 3A/3B	1A/1B - 3A/3B	Splitter
0	1	2A/2B - 4A/4B	2A/2B - 4A/4B	Splitter
1	0	1A/1B - 3A/3B	1A/1B - 3A/3B	Router
1	1	2A/2B - 4A/4B	2A/2B - 4A/4B	Router

Note:

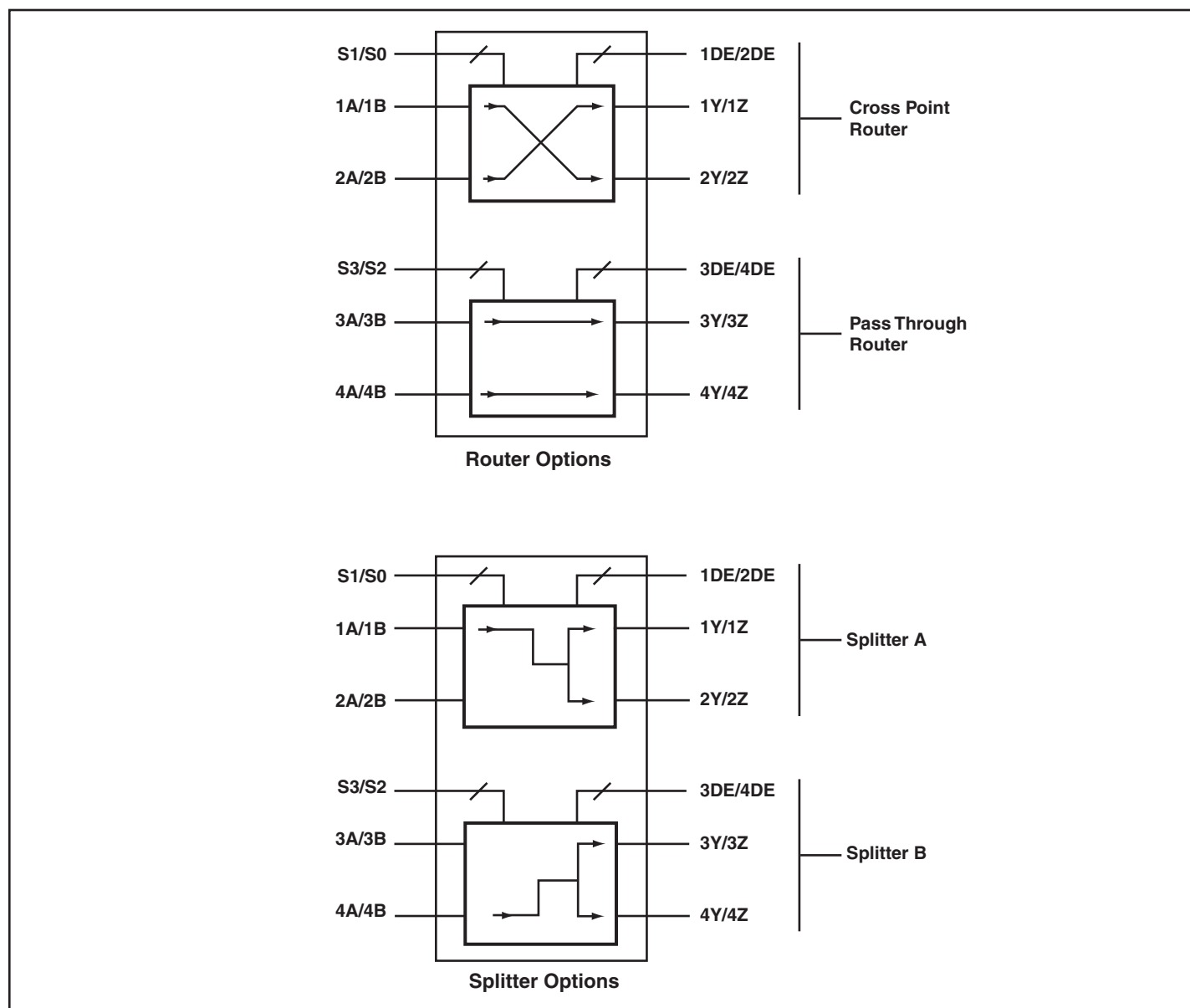
- Setting nDE to 0 will set Output nY/nZ to High Impedance.

Figure 1. Possible Signal Routing

Absolute Maximum Ratings Over Operating Free-Air Temperature⁽¹⁾

Supply Voltage Range, V_{CC} ⁽¹⁾	-0.5V to 4V
Voltage Range (DE, S0, S1).....	-0.5 to 6V
Input Voltage Range, V_I (A or B).....	-0.5V to $V_{CC} + 0.5V$
Electrostatic Discharge: A, B, Y, Z, and GND ⁽²⁾	Class 3, A: 16kV, B:600V
All Pins.....	Class 3, A: 7kV, B:500V
Storage Temperature Range	-65°C to 150°C
Lead Temperature 1, 6 mm (1/16 inch) from case for 10 seconds.....	260°C

Notes:

1. Stresses beyond those listed under "Absolute Maximum Ratings" may cause permanent damage to the device. These are stress ratings only, and functional operation of the device at these or any other conditions beyond those indicated under "Recommended Operating Conditions" is not implied. Exposure to Absolute-Maximum-Rated conditions for extended periods may affect device reliability.
2. All voltage values, except differential I/O bus voltages, are with respect to ground terminal.
3. Tested in accordance with MIL-STD-883C Method 3015.7

Recommended Operating Conditions

		Min.	Nom.	Max.	Units
Supply Voltage, V_{CC}		3.0	3.3	3.6	V
High-Level input voltage, V_{IH}	S1 - S3, 1DE - 4DE	2			
Low-Level input voltage, V_{IL}				0.8	
Magnitude of Differential Input Voltage $ V_{ID} $		0.1		0.6	
Common Mode input voltage, V_{IC} (see figure 2)		$\frac{ V_{ID} }{2}$		$2.4 - \frac{ V_{ID} }{2}$	
				$V_{CC} - 0.8$	
Operating free-air Temperature, T_A		-40		85	°C

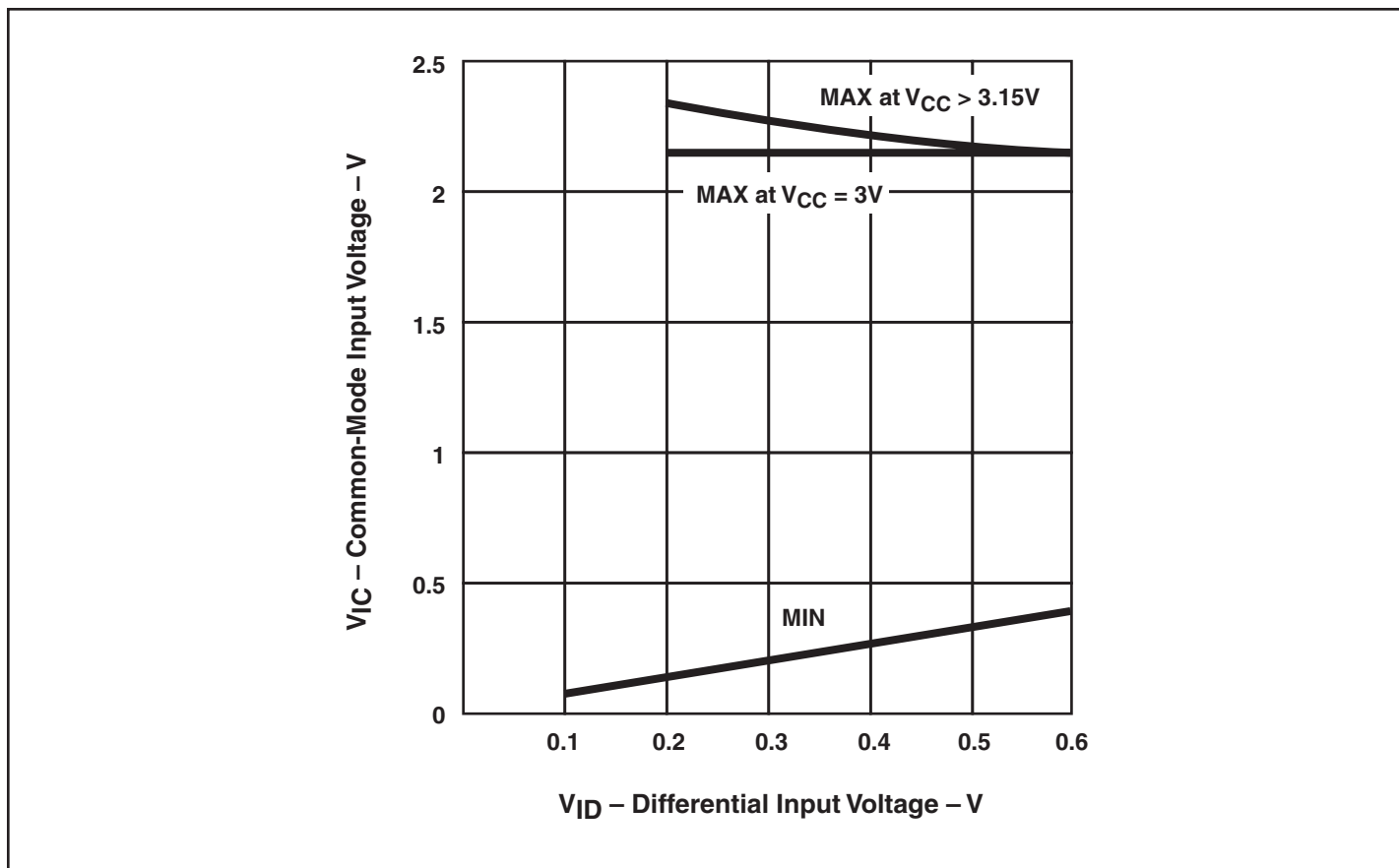

Figure 2. Common-Mode Input Voltage vs. Differential Voltage

Receiver Electrical Characteristics Over Recommended Operating Conditions (unless otherwise noted)

Symbol	Parameter	Test Conditions	Min.	Typ. ⁽¹⁾	Max.	Units
V_{ITH+}	Positive going differential input voltage threshold	$V_{CM} = 1.2V$			100	mV
V_{ITH-}	Negative going differential input voltage threshold		-100			
I_I	Input current (A or B inputs)	$V_I = 0V$	-2		-20	μA
		$V_I = 2.4V$	-1.2			
$I_{I(OFF)}$	Power-off input current (A or B inputs)	$V_{CC} = 0V$			20	

Receiver/Driver Electrical Characteristics Over Recommended Operating Conditions (unless otherwise noted)

Symbol	Parameter		Test Condition	Min.	Typ. ⁽¹⁾	Max.	Units
V _{OD}	Differential Output voltage magnitude		R _L = 100Ω (LV) R _L = 50Ω (LVB)	247	440	590	mV
ΔV _{OD}	Change in differential Output voltage magnitude between logic states			-50		50	
V _{OC(SS)}	Steady-state common-mode output voltage			1.062		1.375	V
ΔV _{OC(SS)}	Change in steady-state common-mode output voltage between logic states			-50	3	50	mV
V _{OC(PP)}	Peak-to-peak common-mode output voltage					150	
I _{CC}	Supply Current		No load		16	24	mA
			R _L = 100Ω (LV)		26	40	
			R _L = 50Ω (LVB)		42	54	
			All Channels Disabled		6	12	
I _{IH}	High level input current	DE	V _{IH} = 5			40	nA
		S1, S2, S3, S4				-3	μA
I _{IL}	Low level input current	DE	V _{IL} = 0.8V			-20	nA
		S1, S2, S3, S4				10	μA
I _{OS}	Short circuit output current		V _{OY} or V _{OZ} = 0V, V _{OD} = 0V			-10	mA
I _{OZ}	High impedance output current		V _{OD} = 600mV		1.5	±25	nA
			V _O - 0V or V _{CC}		1.5	±25	
I _{O(OFF)}	Power off output current		V _{CC} = 0V, V _O = 3.6V		1.5	±40	
C _{IN}	Input Capacitance		S0 - S3, 1DE - 4DE		3		pF
					8		

Note:

- All typical values are at 25°C and with a 3.3 supply

Differential Receiver to Driver Switching Characteristics Over Recommended Operating Conditions
(unless otherwise noted)

Symbol	Parameter	Test Condition	Min.	Typ. ⁽¹⁾	Max.	Units	
t _{PLH}	Differential propagation delay, low-to-high	C _L = 10pF		4.0	6.0	ns	
t _{PHL}	Differential propagation delay, high-to-low			4.0	6.0		
t _{sk(p)}	Pulse skew (t _{PHL} = t _{PLH})			0.25	0.3		
t _r	Transition, low-to-high		LV044		1.0		1.5
			LVB044		0.8		1.3
t _f	Transition, high-to-low		LV044		1.0		1.5
			LVB044		0.8		1.3
t _{PHZ}	Propagation delay time, high-level-to-high-impedance output				4.0		10
t _{PLZ}	Propagation delay time, low-level-to-high-impedance output				4.3		10
t _{PZH}	Propagation delay time, high-impedance to high-level output				3.0		10
t _{PZL}	Propagation delay time, high-impedance to low-level output			2.0	10		
t _{PHL_R1_Dx}	Channel-to-channel skew, receiver to driver ⁽²⁾			-	95	ps	
t _{PLH_R1_Dx}				-	95		
t _{PHL_R2_Dx}				-	95		
t _{PLH_R2_Dx}				-	95		

Notes:

1. All typical values are at 25°C and with a 3.3 supply
2. These parametric values are measured over supply voltage and temperature ranges recommended for the device

Parameter Measurement Information

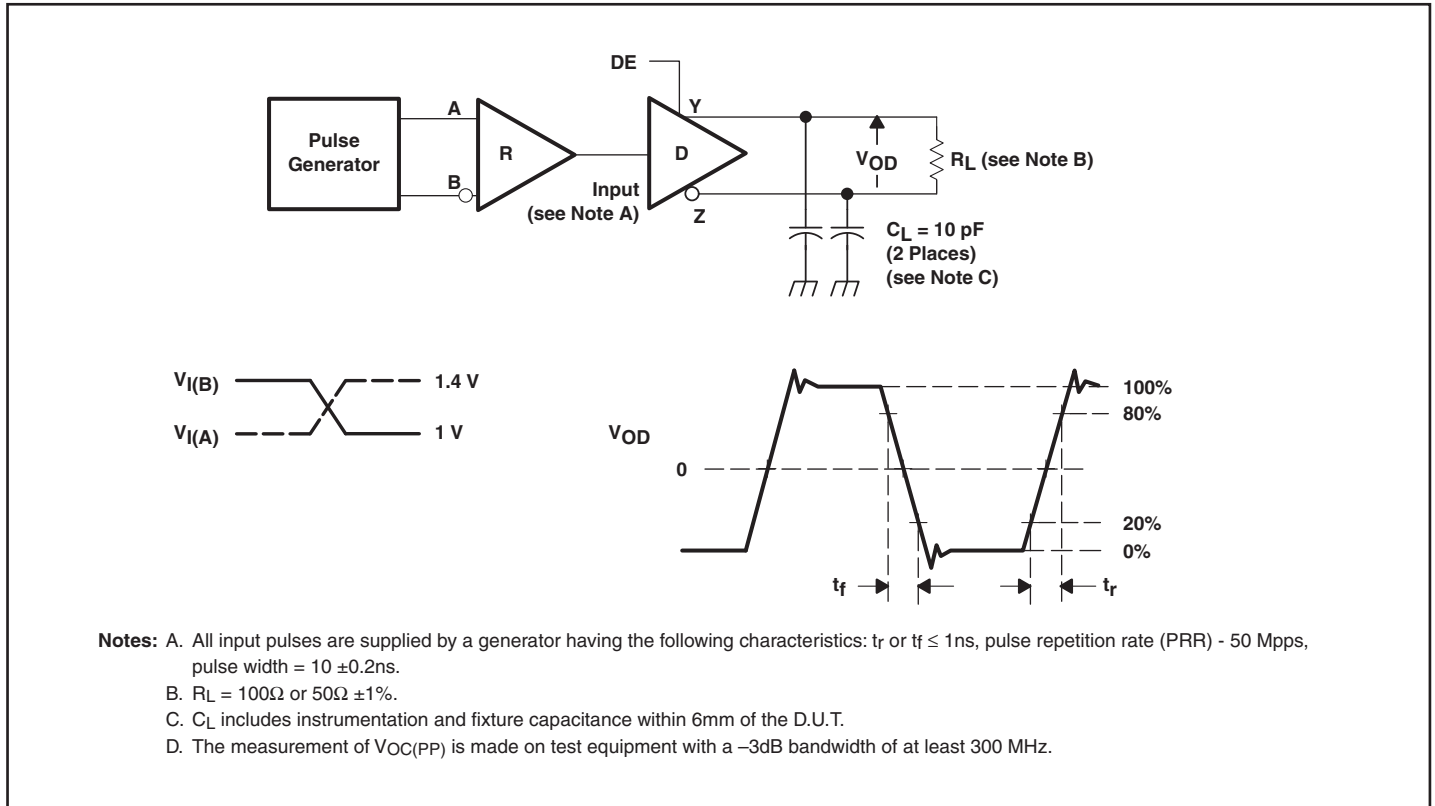

Figure 3. Test Circuit and Voltage Definitions for the Differential Output Signal

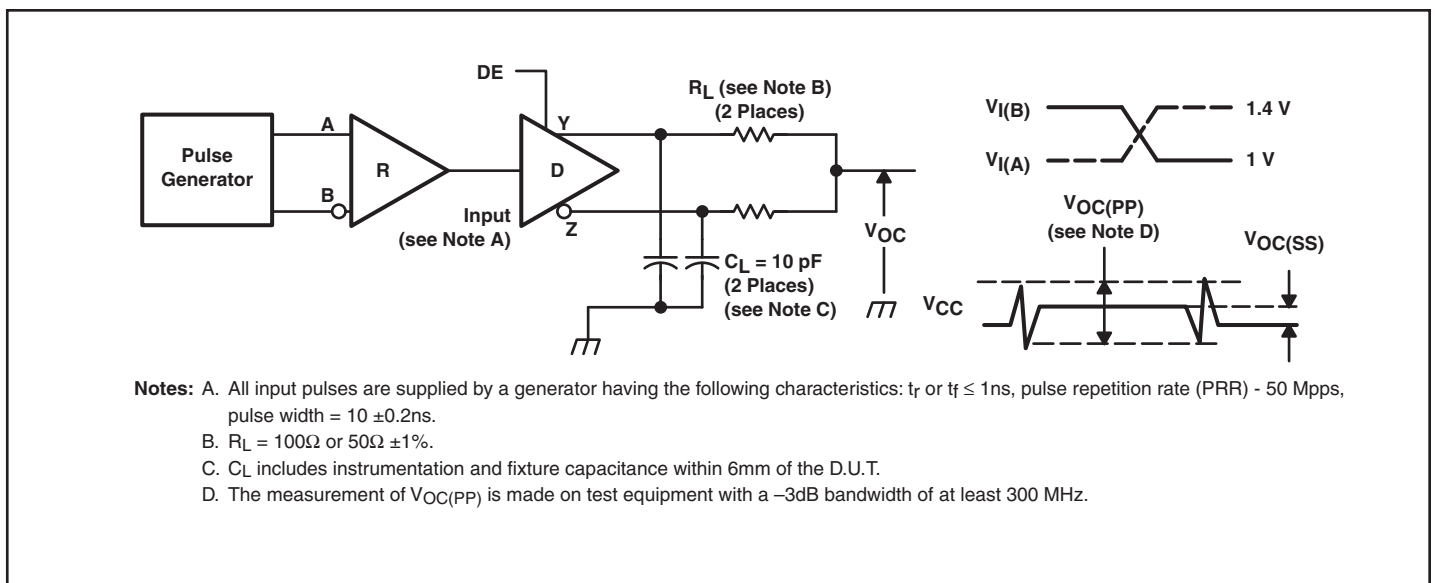

Figure 4. Test Circuit and Definitions for the Driver Common-Mode Output Voltage

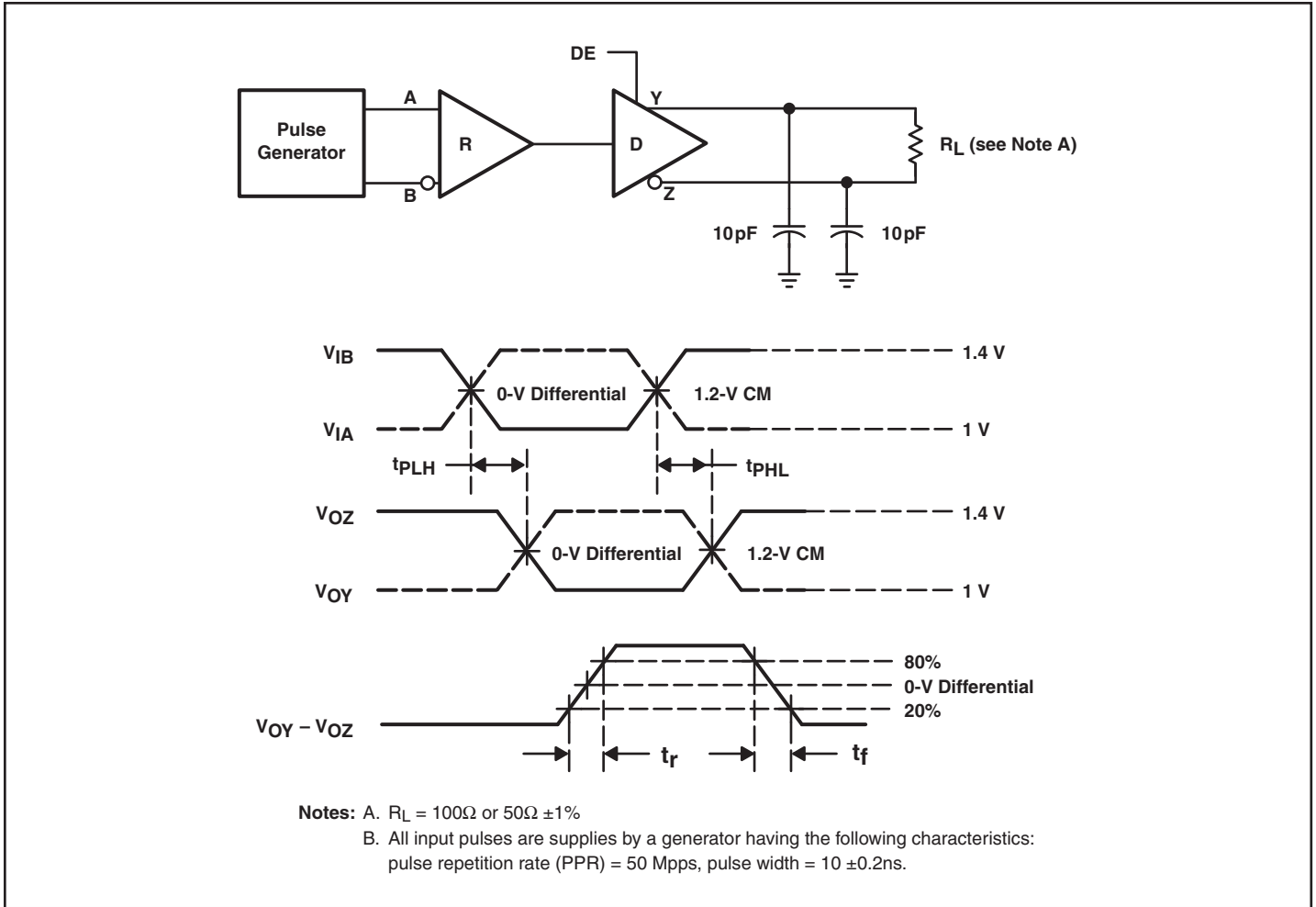

Figure 5. Differential Receiver to Driver Propagation Delay and Driver Transition Time Waveforms

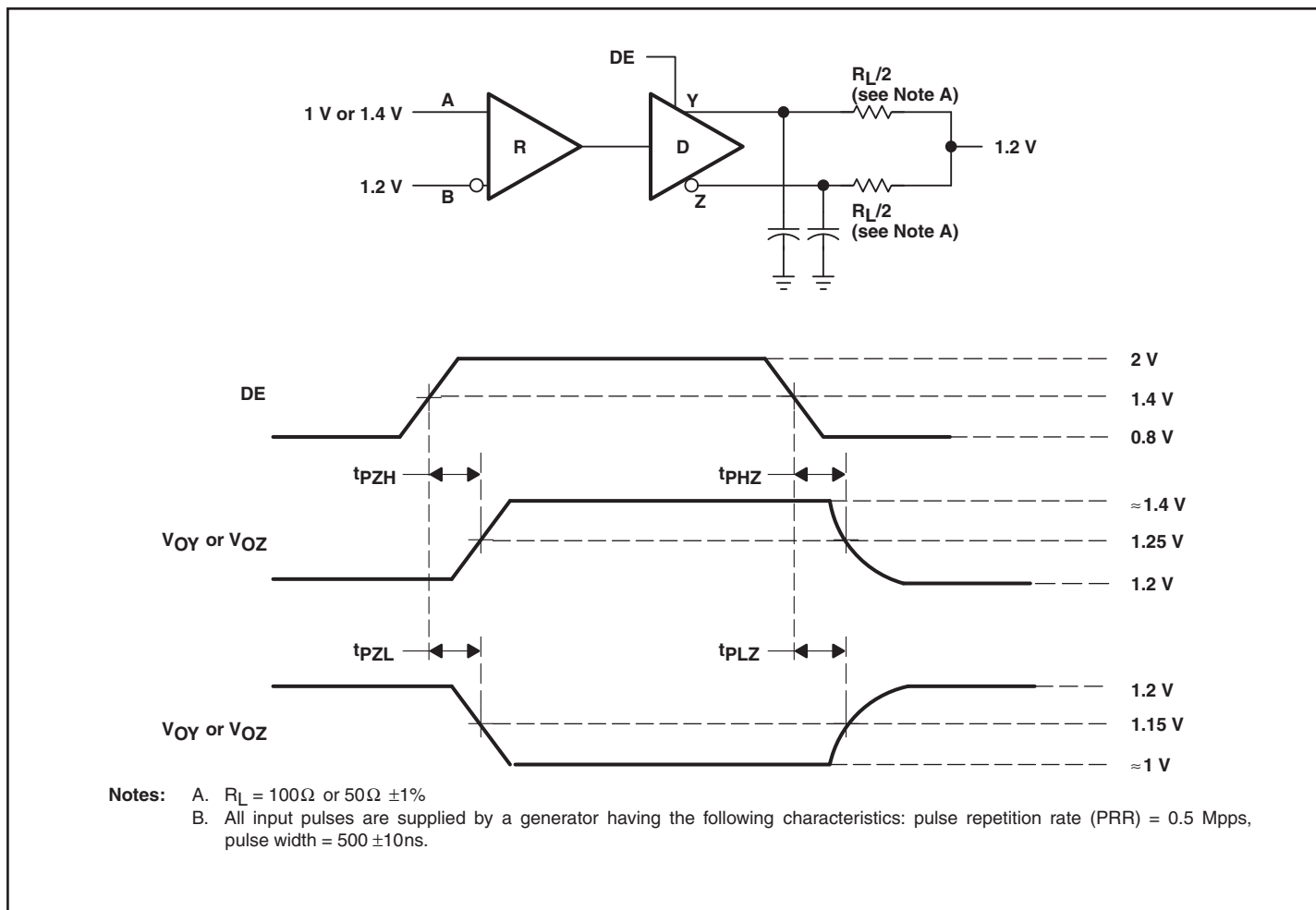
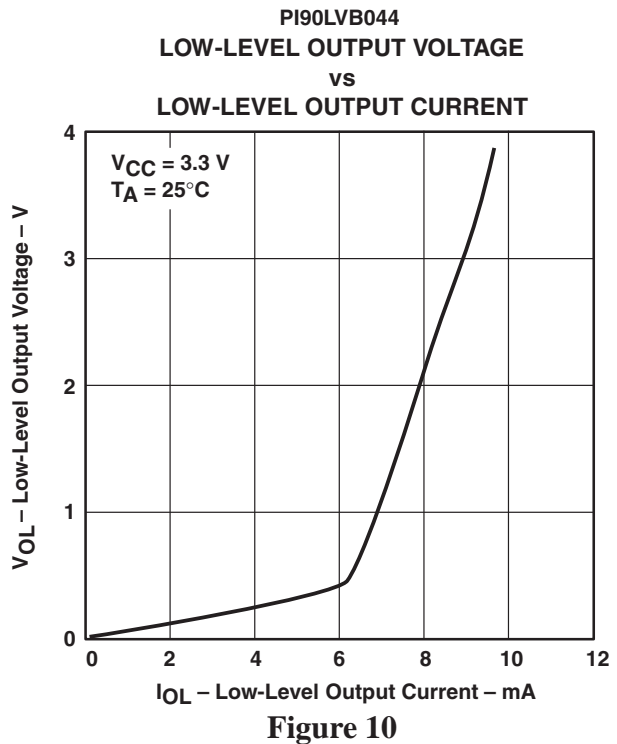
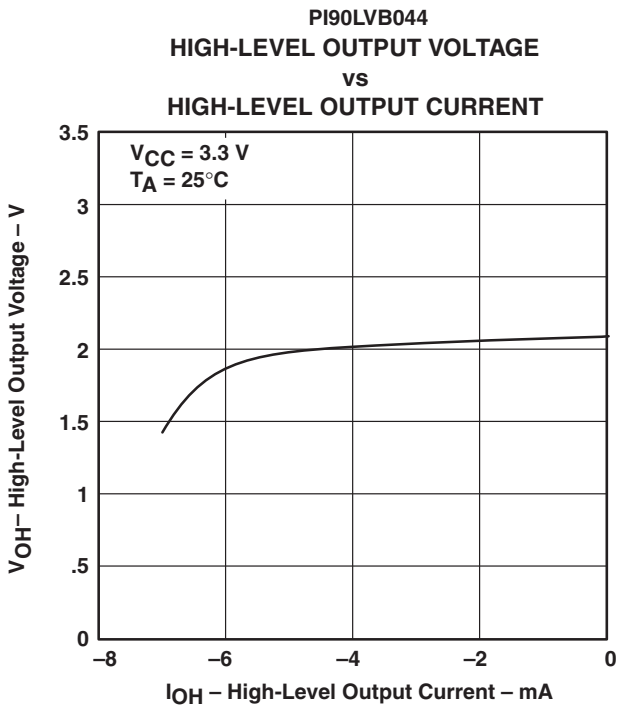
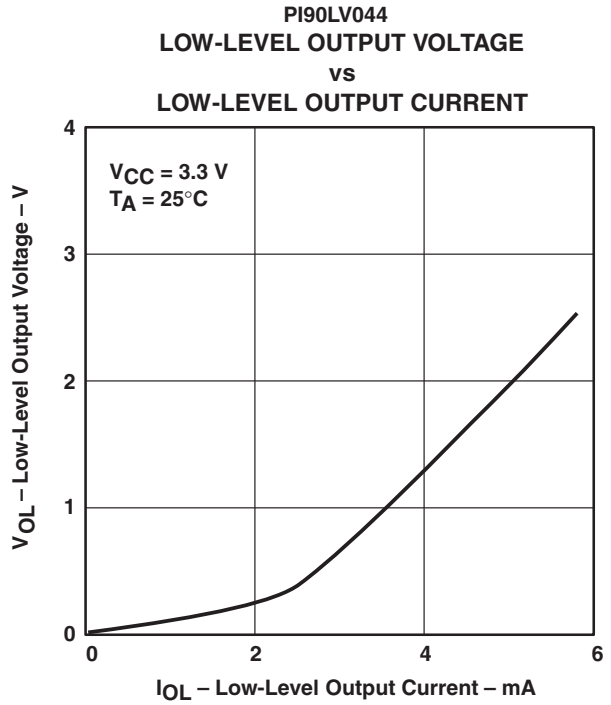
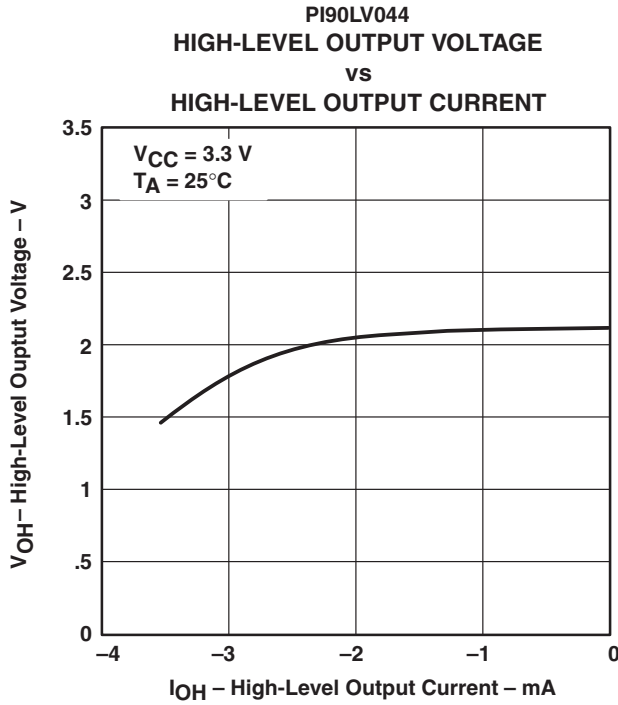
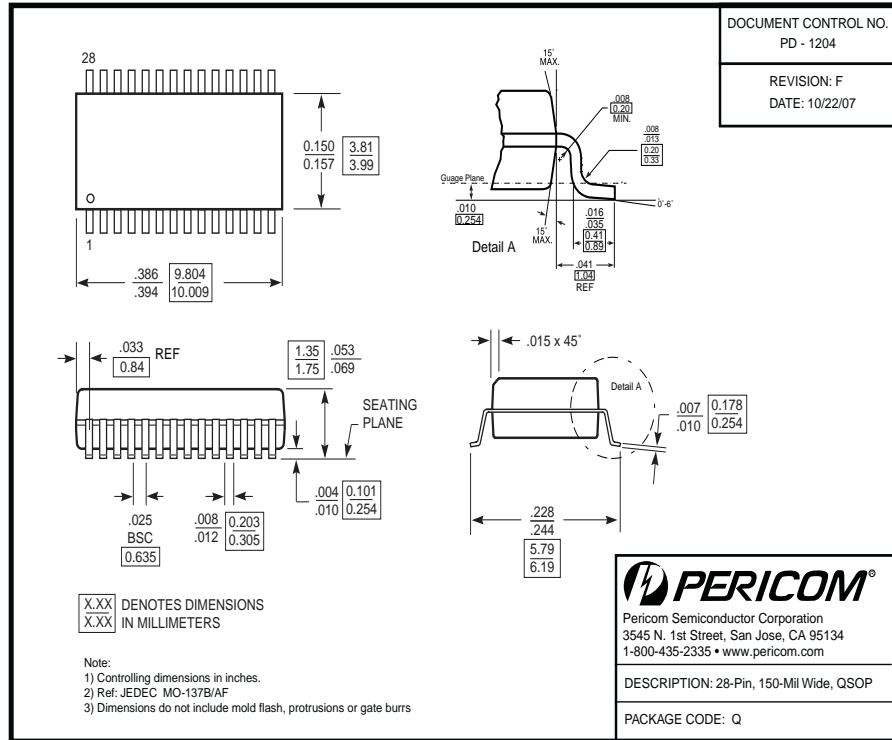

Figure 6. Enable and Disable Timing Circuit

Typical Characteristics

Packaging Mechanical: 28-Pin QSOP (Q)



Packaging Mechanical: 28-Pin TSSOP (L)

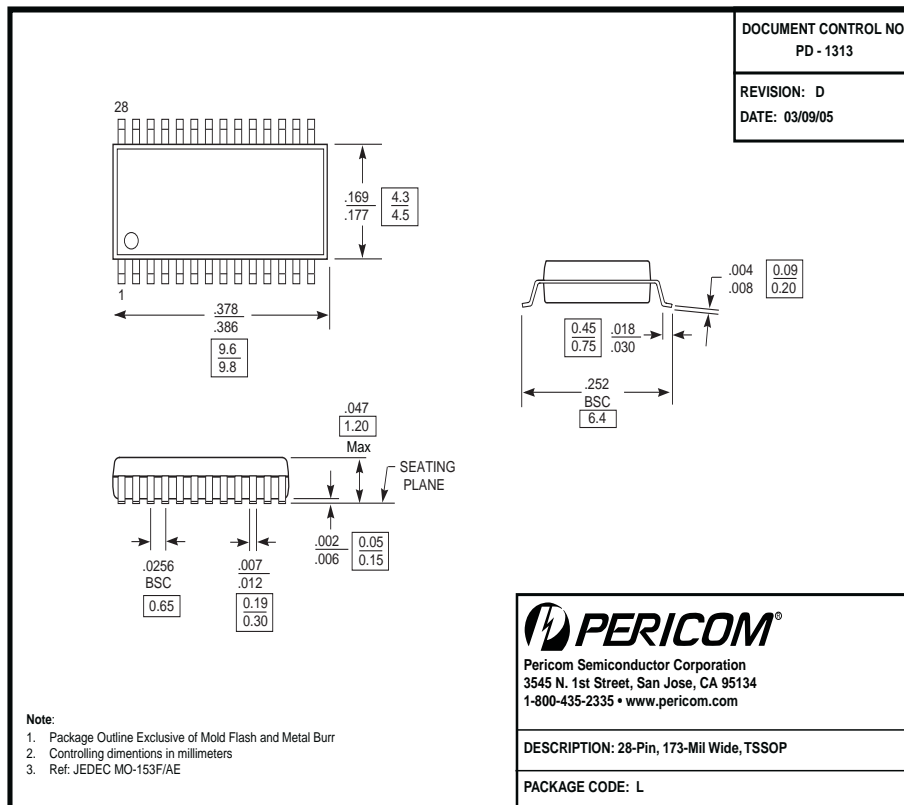

Ordering Information

Ordering Code	Package Code	Package Type
PI90LV044QE	Q	Pb-free & Green, 28-Pin 150-mil QSOP
PI90LV044LE	L	Pb-free & Green, 28-pin 170-mil TSSOP
PI90LVB044QE	Q	Pb-free & Green, 28-Pin 150-mil QSOP
PI90LVB044LE	L	Pb-free & Green, 28-pin 170-mil TSSOP

Notes:

1. Thermal characteristics can be found on the company web site at www.pericom.com/packaging/
2. Number of Transistors = TBD