

# Digital Timer H5AN

## DIN-sized (72 x 72 mm) Quartz Timer with Multiple Functions

- Wide time range from 1/100 seconds to 9999 hrs.
- Built-in power supply incorporated in timer enables direct connection of sensors and other components.
- Draw-out construction allows maintenance without disconnecting the wiring.
- Power supply freely selectable within a range of 100 to 240 VAC; a DC-operated version is also available.
- Control outputs of both contact type and solid-state type simultaneously available.
- Seven operating modes (N, F, C, R, K, P, and Q) are available.



## Ordering Information

Operation system	Resetting system	No. of digits	Backup power supply function for memory protection	Model
Time-limit operation, integrating operation	Power-OFF resetting (excluding -M), external resetting, manual resetting, automatic resetting	4 digits (switch-selectable): 0.01 to 99.99 s, 0.1 to 999.9 s, 1 to 9999 s, 0.1 to 999.9 min, 0.1 to 999.9 hrs, 1 to 9999 hrs, 1 s to 99 min 59 s, 1 min to 99 hrs 59 min	Not provided	H5AN-4D
			Provided (approx. 10 years at 20°C)	H5AN-4DM

- Note:**
1. Specify both the model number and supply voltage when ordering.
  2. The Timer is supplied with two mounting fixtures.

# Specifications

## ■ Ratings

Item	H5AN-4D/H5AN-4DM
Rated supply voltage	H5AN-4D: 100 to 240 VAC (50/60 Hz), 12 to 24, 48, or 100 VDC (permissible ripple: 20% max.) H5AN-4DM: 100 to 240 VAC (50/60 Hz) 12 to 24 VDC (permissible ripple: 20% max.)
Operating voltage range	85% to 110% of rated supply voltage
Power consumption	Approx. 10 VA (at 240 VAC, 50 Hz), approx. 5 W (at 24 VDC)
Resetting system and gate input	Reset by power-OFF: min. power OFF time: 0.5 s External reset or gate (common to contact and solid-state inputs): min. reset input signal width: 0.02 s
One-shot output time	0.1 to 1 s (adjustable)
Control outputs	Contact output: SPDT, 3 A at 250 VAC, resistive load ( $\cos\phi = 1$ ) Solid-state output: Open collector, 100 mA max. at 30 VDC max.
Power supply for externally connected components	12 VDC $\pm$ 10%, 80 mA (permissible ripple: 5% max.)

**Note:** Inrush current was measured within the range shown below.

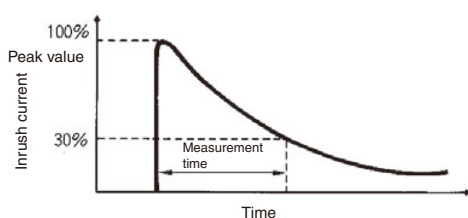

## ■ Characteristics

<b>Accuracy of operating time</b>	$\pm 0.01\% \pm 0.05$ s max. (power OFF start), $\pm 0.005\% \pm 0.03$ s max. (reset start) (see note)
<b>Setting error</b>	
<b>Influence of voltage</b>	
<b>Influence of temperature</b>	
<b>Insulation resistance</b>	100 M $\Omega$ min. (at 500 VDC) (between current-carrying terminal and exposed non-current carrying metal parts, between non-continuous contacts)
<b>Dielectric strength</b>	2,000 VAC, 50/60 Hz for 1 min (between current-carrying and non-current-carrying metal parts) 750 VAC, 50/60 Hz for 1 min (between non-continuous contacts)
<b>Vibration resistance</b>	Destruction: 10 to 55 Hz with 0.75-mm double amplitude Malfunction: 10 to 55 Hz with 0.5-mm double amplitude
<b>Shock resistance</b>	Destruction: 300 m/s <sup>2</sup> (approx. 30G) Malfunction: 100 m/s <sup>2</sup> (approx. 10G)
<b>Ambient temperature</b>	Operating: $-10^{\circ}\text{C}$ to $55^{\circ}\text{C}$ Storage: $-25^{\circ}\text{C}$ to $65^{\circ}\text{C}$
<b>Ambient humidity</b>	Operating: 35% to 85%
<b>Life expectancy</b>	Mechanical: 10,000,000 operations min. (under no load at 1,800 operations/h) Electrical: 100,000 operations min. (3 A at 250 VAC, resistive load)
<b>Approved standards</b>	UL (File No. E41515), CSA (File No. LR22310)
<b>Weight</b>	Approx. 360 g

**Note:** This value denotes the average of the repeat accuracy, setting error, and variations due to voltage and temperature changes. It includes the rise time of the power supply, and the operating time of the internal and output circuits.

# Engineering Data

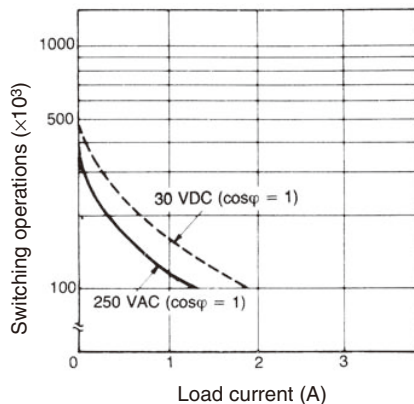
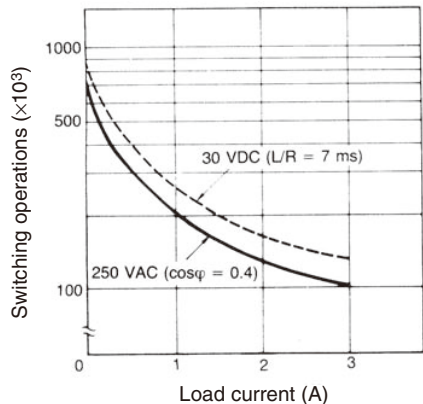

Reference: A maximum current of 0.15 A can be switched at 125 VDC (cosφ = 1).  
 Maximum current of 0.1 A can be switched if L/R is 7 ms. In both cases,  
 a life of 100,000 operations can be expected. The minimum applicable  
 load is 10 mA at 5 VDC (P reference value).

# Nomenclature

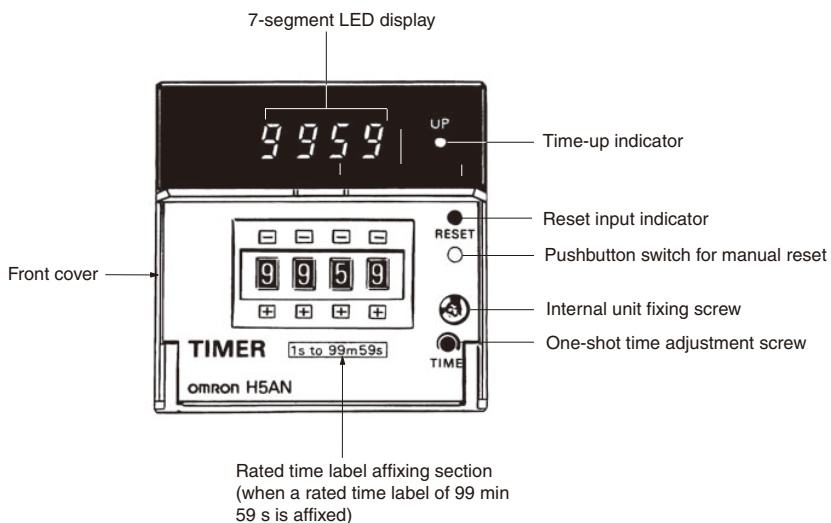

# Operation

## ■ Timing Chart

### Digital Display

#### UP Display

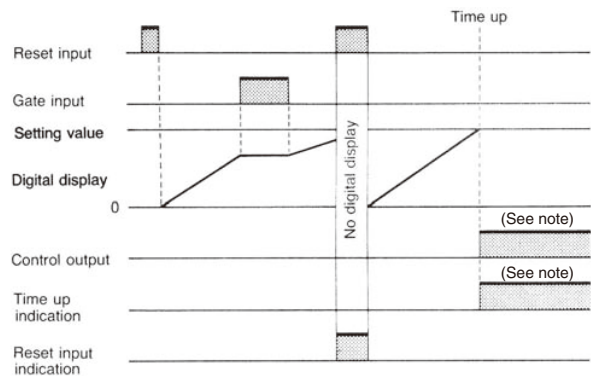

#### DOWN Display

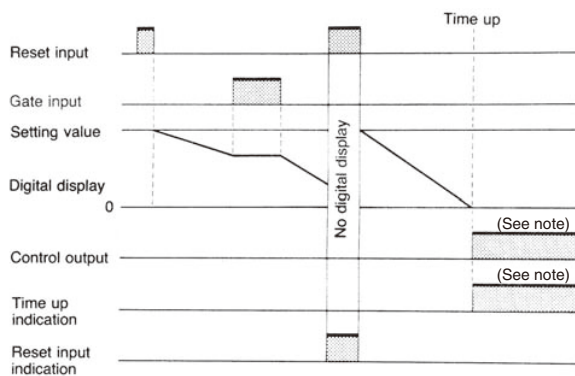

**Note:** After the set time has elapsed, operation continues according to the mode (N, F, C, R, K, P, or Q).

### Operation Mode

(The control output and digital display when the set time is up differ in each of the operation modes available.)



Mode	UP display	DOWN display	Operation after the set time is up
<b>N</b>			The control output and digital display are held until a reset input is applied.
<b>F</b>			In UP mode, the digital display continues to increment up to "9999" even after reaching the set value and then returns to all zeroes. In DOWN mode, the digital display continues to up 9999, and then decrements "9998, 9997, ..." after reaching all zeroes. The control output is held until a reset input is applied.
<b>C</b>			The digital display returns to the initial setting once the set time has elapsed and the timer restarts the timing operation. When the set time has elapsed, the output signal is generated during the one-shot time. The timer repeats this cycle.
<b>R</b>			The digital display returns to the initial setting after the one-shot time and the timer restarts the timing operation. When the set time has elapsed, the output signal is generated during the one-shot time. The timer repeats this cycle.

Mode	UP display	DOWN display	Operation after the set time is up
<b>K</b>			<p>In UP mode, the digital display continues to increment up to "9999", even after reaching the set value and then returns to all zeroes. In DOWN mode, the digital display continues up to 9999, and the decrements "9998, 9997, ..." after reaching all zeroes. The timer restarts the timing operation when the incrementing or decrementing value reaches the set value.</p> <p>The output is generated during the one-shot time. The timer repeats this cycle.</p>
<b>P</b>			<p>For the digital display, the value at the up is held during the one-shot time; however, the timing operation of the timer returns to the initial setting when the set time has elapsed and the timer restarts the timing operation. When the set time has elapsed, the output signal is generated during the one-shot time. The timer repeats this cycle.</p>
<b>Q</b>			<p>In UP mode, the digital display continues to increment after reaching the set value during the one-shot time. In DOWN mode, the digital display continues to 9999 and then decrements "9998, 9997, ..." after reaching all zeros during the one-shot time. However, in both UP and DOWN modes, the digital display returns to the initial setting after the one-shot time and the timer restarts the timing operation. When the set time has elapsed, the output signal is generated during the one-shot time. The timer repeats this cycle.</p>

- Note:**
1. When a rated time of 99 min 59 s or 99 h 59 min is selected, the overflow values of the digital display when using the DOWN (countdown) function will be indicated as 9959, 9958, 9957, ... in modes F, K, and Q.
  2. In this timing chart, the number of step advances during the one-shot time varies in accordance with the selected rated time and duration of the one-shot time.
  3. In C and P modes, set time value n should be sufficiently longer than the one-shot time t.

## ■ Programming of Specifications

The built-in specifications selector switches are used for programming UP or DOWN display, rated time, operation mode, and output level of the solid-state output when the set time has elapsed, etc. Set these switches for programming the desired functional specifications by referring to *Positions and Functions of Specification Selector Switches*.

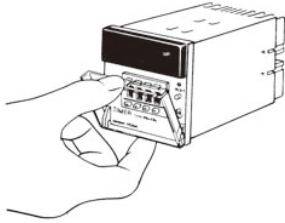

Open the front cover.

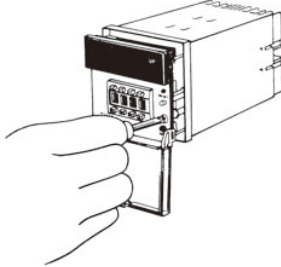

The internal unit comes out by loosening the internal unit fixing screw.

## Positions and Functions of Specification Selector Switches

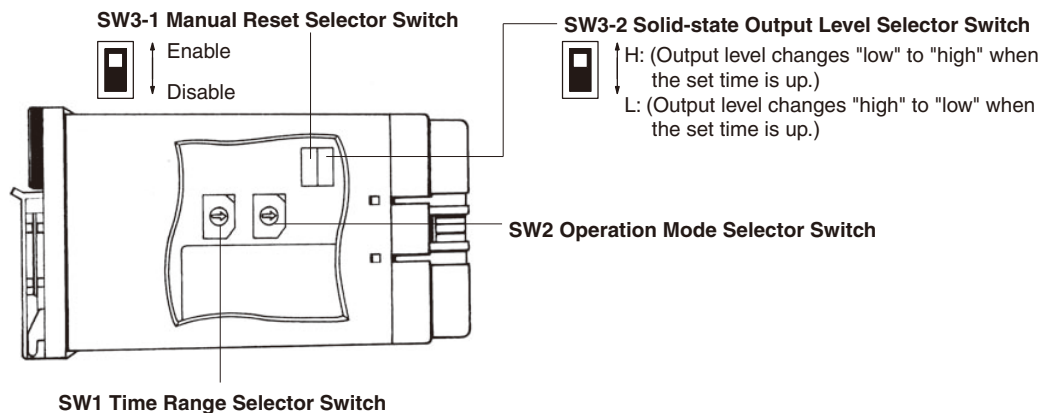

### SW1

Switch position	Rated time	Setting range
0	99.99 s	0.01 to 99.99 s
1	999.9 s	0.1 to 999.9 s
2	9999 s	1 to 9999 s
3	99 min 59 s	1 s to 99 min 59 s
4	999.9 min	0.1 to 999.9 min
5	99 hrs 59 min	1 min to 99 hrs 59 min
6	999.9 hrs	0.1 to 999.9 hrs
7	9999 hrs	1 to 9999 hrs
8	99.99 s	Same as switch position "0"
9	999.9 s	Same as switch position "1"

**Note:** Select the appropriate label, from the rated time labels supplied as accessories, and affix it on the proper position on the front panel.

### SW2

Switch position	Operating mode	Display mode
0	N	DOWN display
1	F	
2	C	
3	R	
4	K	
5	P	
6	Q	
7	N (see note 1)	UP display
8	N	
9	F	
A	C	
B	R	
C	K	
D	P	
E	Q	
F	N (see note 2)	

## Dimensions

**Note:** All units are in millimeters unless otherwise indicated.

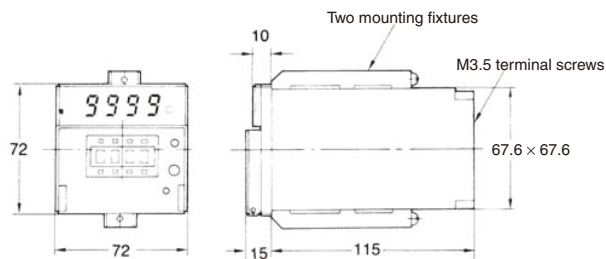

### Panel Cutouts

(Panel cutout conforms to DIN 43700)

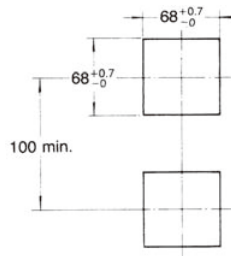

(Horizontally connecting N units)  
 $\{(n - 1) \times 72 + 70\}$  min.  
 (including 2-mm clearance between units)

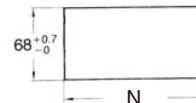

# Installation

## Terminal Arrangement

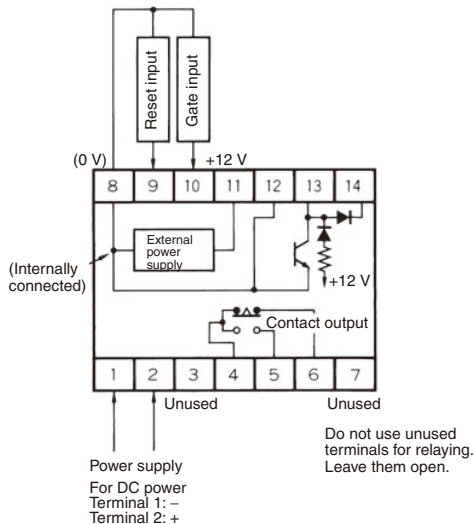

**Note:** Specifications for 12- to 24-VDC, 48-VDC, and 100-VDC models are listed separately in this datasheet.

## Connections

### Power Supply Connection

Connect the required supply voltage to terminals 1 and 2.

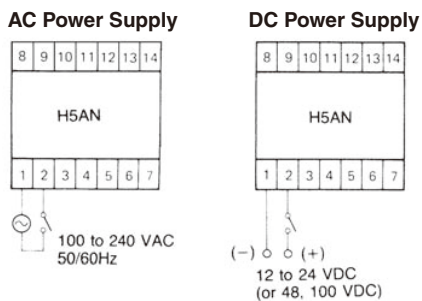

### Load Connection

Terminals 4, 5, and 6 are for contact output while terminals 12 and 13 are for solid-state output. (Terminal 14 is connected to absorb the surge if an inductive load is connected.) The control outputs of both contact type and solid-state type are simultaneously available.

### Load Operation

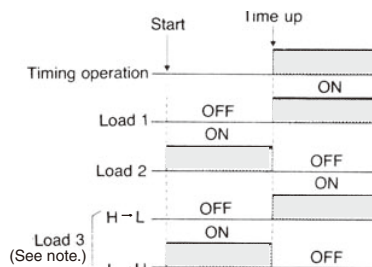

**Note:** Output transistor ON: Low (0 V)  
Output transistor OFF: High (12 V)

#### When a Load Operates with Contact Output

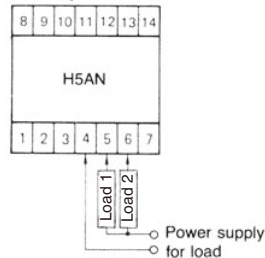

#### When a Load Operates with Solid-state Output

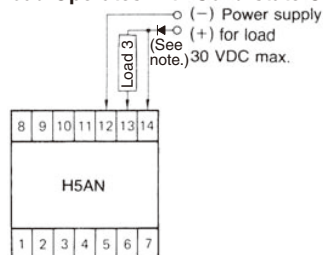

**Note:** Connect a diode when using a Power Supply of 12 V or less.



## Connection of Reset and Gate Inputs

For reset input, connect a contact or an open collector type transistor between terminals 8 and 9. The timer resets when contact is made or when the transistor is ON. For gate inputs, connect a contact or an open collector type transistor between terminals 8 and 10. The timer stops when contact is made or when the transistor is ON. Use a contact of high contact reliability, or an open collector type transistor with characteristics:  $V_{CE0} = 20\text{ V min.}$ ,  $V_{CE(S)}$  (residual voltage) =  $3\text{ V max.}$ ,  $I_C = 50\text{ mA min.}$  and  $I_{CBO}$  (leakage current) =  $0.5\text{ }\mu\text{A max.}$  Use of a gate input contact with minimum contact bounce (chatter) is a must, since the contact bounce time will cause an error in timer operating time.

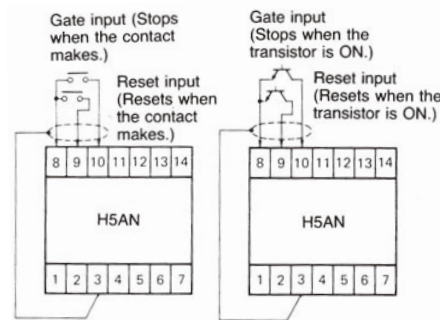

When connecting a solid-state circuit not of the open collector type to the gate or reset inputs as shown below, the voltage of the solid-state circuit (+V) should be 13 to 30 V, and the  $V_{CE(S)}$  of the transistor should be less than 3 V (the current that flows from either terminal 9 or 10 is approximately 10 mA). Moreover, it is essential that the circuit be ON for gate or reset input, and OFF when there is no input.

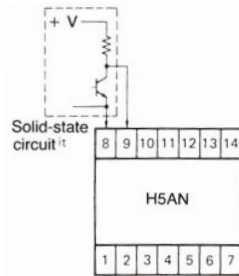

## Connection of a Power Supply for Externally Connected Components

The H5AN has a built-in power supply for externally connected components such as sensors for gate or reset input, or loads connected to the solid-state control output (12 VDC, 80 mA). Power can be applied to the sensors and loads simultaneously.

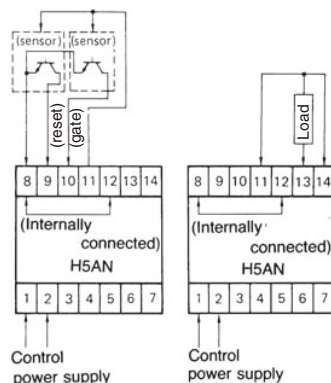

## Simultaneous Input to a Number of H5AN Timers with the Same Contact or the Same Open Collector Transistor

A reset or gate input may be applied to two or more units of H5AN with only one contact or transistor as shown below. In this case, caution is required as a large current flows into the transistor. (The current that flows from H5AN is approximately 10 mA per unit.)

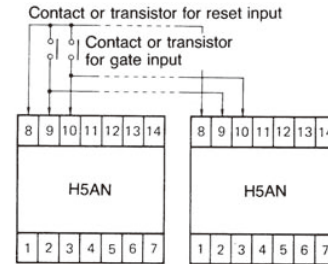

# Safety Precautions

## Setting of Operating Time

### Time Setting Range

Rated time	Setting range
99.99 s	0.01 to 99.99 s (see note)
999.9 s	0.1 to 999.9 s (see note)
9999 s	1 to 9999 s
99 min 59 s	1 s to 99 min 59 s
999.9 min	0.1 to 999.9 min (see note)
99 hrs 59 min	1 min to 99 hrs 59 min
999.9 hrs	0.1 to 999.9 hrs (see note)
9999 hrs	1 to 9999 hrs

**Note:** The decimal point is not shown in the digital display.

1. Since the H5AN Timer is capable of reading the input data at any time during normal operation, the set time can be changed during power application. This feature sets back the output from the timer by temporarily setting the longer time or quickens the output by setting the shorter time. During normal operation, the set time may be accidentally changed by touching a thumbwheel switch, causing the timer to operate with a different set time. To prevent this possibility, keep the front cover closed except when changing the set time.
2. When the set time is all zeroes (e.g., 000.0 s or 00 hrs 00 min), there will be a momentary control output upon power application which can be used to check normal output. When changing the set time during normal operation, pay special attention not to alter the set value to this state.
3. Since the sexagesimal system is adopted, when a rated time of 99 min 59 s or 99 hrs 59 min is selected, any value set to 6 or more (i.e. 6-9) in the order of x 10 s or x 10 min respectively will be rated as 5. Some erroneous setting examples are shown below.

### Examples of Setting/Actual Operating Time

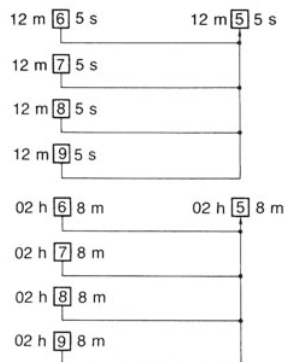

4. When changing the set time while power is being supplied, an inadequate push of the thumbwheel switches will display two numbers in one digital display window, causing the operating time to drift widely. Therefore, press the thumb-wheel switches surely. Take particular care in the case when the other three digits are all zero, since the improper setting of the fourth switch to create four zeroes will cause a momentary output.

(Undesirable Setting) → (Possible Operating Time)

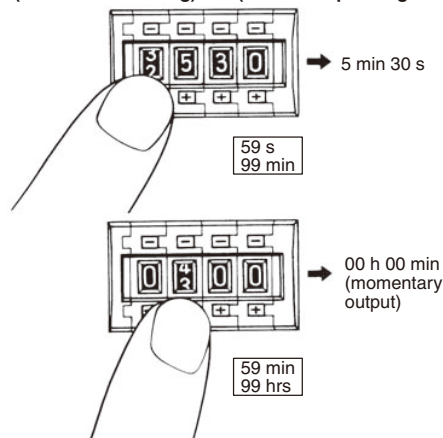

5. When operating the built-in selector switches of the H5AN-4DM Timer with a backup power supply function for memory protection, it is necessary to reset (either externally or manually) the timer at the time the power is applied. Also when this type of timer is connected to a device (or manually) this must also be done when power is applied for the first time.

**Note:** If the timer is not reset, it operates in accordance with the previous specifications or with the factory set specifications.

## Resetting of Type with a Backup Power Supply Function for Memory Protection

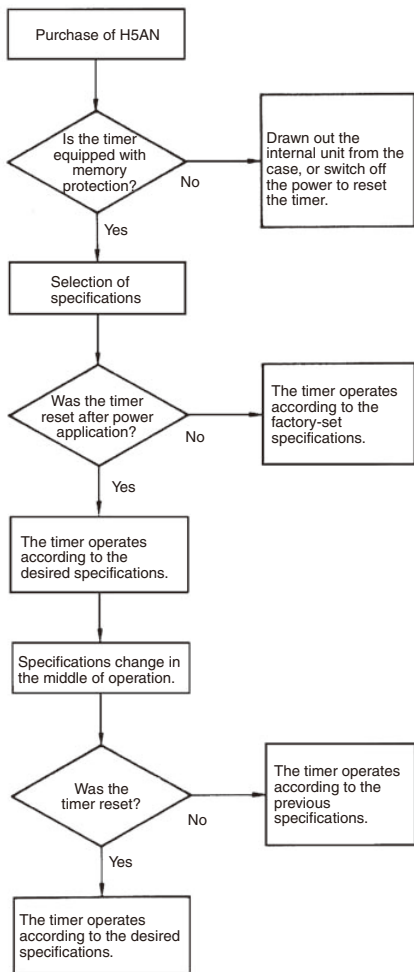

6. The type without a backup power supply function for memory protection operates as shown below depending on the duration of the power failure.

(A) Power failure of 0.01 s max.

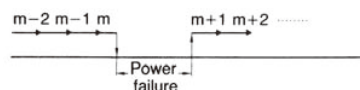

**Note:** The timer starts in the initial setting upon power recovery.

(B) Power failure of 0.5 s min.

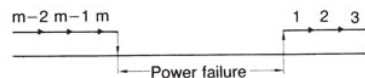

**Note:** The timer starts in the initial setting upon power recovery.

(C) Power failure of 0.01 to 0.5 s.

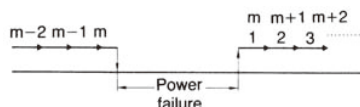

**Note:** Either (A) or (B)

The type with a backup power supply function for memory protection restarts in the status preceding the power failure as shown in (A), regardless of the duration of the power failure.

- The type with backup power supply for memory protection incorporates a battery for backup power supply which lasts for about ten years of normal use, meaning data is retained even during a power failure lasting ten years. (The battery cannot be replaced.)
- When using the timer in operation modes other than N and F modes (i.e., C, R, K, P, and Q), the control output is available for the one-shot time only. For this reason, adjust the one-shot time by rotating the one-shot time adjustment screw on the front panel (variable within a range to 0.1 to 1 s).

## Mounting

A Mounting Fixture is included with the H5AN. Mount the Unit using the Mounting Fixture so that the Unit is secure and does not move

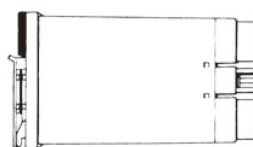

Loosen (to the left) the screws on the Mounting Fixture sufficiently and attach it from the bottom.

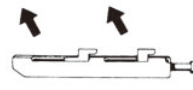

(Y92H-5)

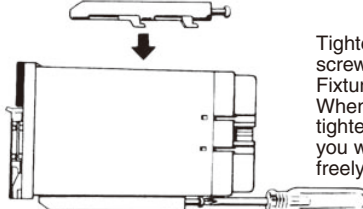

Tighten (to the right) the screws on the Mounting Fixture completely. When the screw is tightened completely, you will hear it turning freely in place.

A model is also available for vertical gang-mounting (Model H5AN-4D(M)-300).

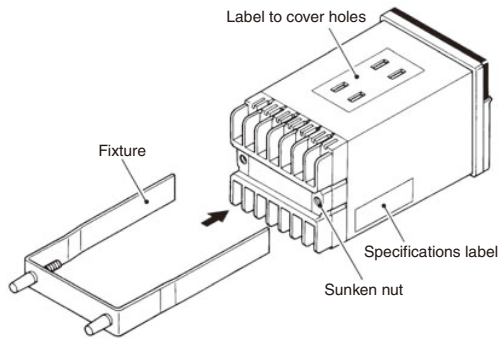

## **⚠ WARNING**

### **Fire, Explosion, and Severe Burn Hazard**

The H5AN has a built-in lithium battery. Be sure to dispose of the old H5AN properly, as lithium batteries are likely to explode if incinerated.

ALL DIMENSIONS SHOWN ARE IN MILLIMETERS.

To convert millimeters into inches, multiply by 0.03937. To convert grams into ounces, multiply by 0.03527.

In the interest of product improvement, specifications are subject to change without notice.

## Correctly Handling Input Signals

Malfunction due to noise may occur if input wiring is placed in the same duct or conduit as power lines or high-voltage lines. Separate input wiring from power lines and wire them in a separate system. Also, use shielded cables, use metal conduits, and keep wiring distances as short as possible.

## Timers with Relays

- Do not connect a load that exceeds contact ratings, such as the switching capacity (contact voltage or contact current). Insulation faults, contact welding, contact faults, and other failures to achieve specified performance may occur and the relay may be damaged or may burn.
- Continued use with deteriorated performance may ultimately result in insulation breakdown between circuits or relay burning. The life of the built-in relay is greatly affected by switching conditions. Before using the Timer, test operation under actual application conditions and confirm that the switching frequency presents no problems in performance.
- Electrical life depends on the type of load, switching frequency, and ambient environment. Observe the following precautions when using the Timer. When switching a DC load, contact transfer may cause the contacts to stick or may cause contact failure. Confirm applicability and consider using a surge absorbing element. When switching at high frequencies, heat generated by arcing may cause contacts to melt or may cause metal corrosion. Consider connecting an arc absorbing element, reducing the switching frequency, or lowering the humidity.
- The surge current depends on the type of load, which also affects contact switching frequency and the number of operations. Check the rated current and the surge current, and design the circuits with sufficient margin.

Resistive load	Solenoid load	Motor load	Incandescent lamp load
Rated current	10 to 20 times the rated current	5 to 10 times the rated current	10 to 20 times the rated current

Sodium light loads	Capacitor loads	Transformer loads	Mercury light loads
1 to 3 times the rated load	20 to 40 times the rated load	5 to 15 times the rated load	1 to 3 times the rated load

- Arcing when switching and relay heating may result in ignition or explosion. Do not use the Timer in atmospheres subject to inflammable or explosive gases.
- Contact faults may occur. Do not use the Timer in atmospheres subject to sulfidizing gas, chloride gas, or silicon gas.
- The switching capacity for DC voltage loads is lower than that for AC voltage loads.

## Timers with Non-contact Outputs

- Short faults or open faults may occur due to destruction of the output element. Do not use the Timer for a load that exceeds the rated output current.
- Short faults or open faults may occur due to destruction of the output element from reverse electromotive force. When using the Timer for a DC inductive load, always connect a diode as a countermeasure against reverse electromotive force.

## Other Precautions

- Confirm that you have the correct model before using it.
- Be sure that all terminals are wired correctly.
- Always test the output status with a tester before using a Timer with a built-in keep relay (e.g., the H3CR-H and H3DE-H). Shock resulting from dropping the Timer during transport or handling may cause the output contacts to reverse or to be in a neutral status.
- Leaving the Timer with outputs ON at a high temperature for a long time may hasten the degradation of internal parts (such as electrolytic capacitors). Use the Timer in combination with relays and avoid leaving the Timer with the output turned ON for an extended period of time (e.g., for more than a month). Reference Example (Use the Timer as shown below.)

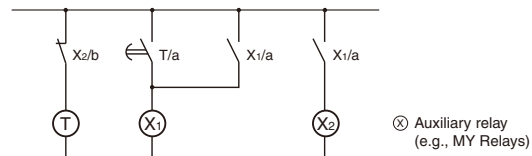

- Be sure that only a qualified worker (e.g., an electrical engineer) performs electrical work for the Timer.

ALL DIMENSIONS SHOWN ARE IN MILLIMETERS.

To convert millimeters into inches, multiply by 0.03937. To convert grams into ounces, multiply by 0.03527.

In the interest of product improvement, specifications are subject to change without notice.

# Safety Precautions for All Timers

Refer to the *Safety Precautions* for individual Timers for precautions specific to each Timer.

## WARNING

The following Timers contain lithium batteries that are not explosion proof.



1. Timers with Built-in Batteries: H5L  
The Timer contains a lithium battery, which may occasionally ignite or rupture. Do not disassemble, deform under pressure, heat to 100°C or higher, or incinerate the Timer.
2. Timers with Replaceable Batteries: Y92S-20 (for H5CN-M)  
The battery may occasionally rupture, ignite, or leak fluid. Do not short the positive and negative terminals. Do not charge, disassemble, deform under pressure, or throw the battery into a fire. If a non-specified battery is used, the battery may leak fluid or rupture, occasionally resulting in equipment failure or minor injury. Use only the specified battery.

## CAUTION

The following Timers contain lithium batteries that are explosion proof.



Timers with Built-in Batteries: H5BR, H5AN-4DM, H5S, H5F, and H4KV

The Timer contains a lithium battery, which may occasionally ignite or rupture. Do not disassemble, deform under pressure, heat to 100°C or higher, or incinerate the Timer.

## Precautions for Safe Use

### Operating Environment

- Use the Timer within the ratings specified for ambient operating temperature and ambient operating humidity for each model.
- Store the Timer with the specified temperature range for each model. If the Timer has been stored at a temperature of less than -10°C, allow the Timer to stand at room temperature for at least 3 hours before using it.
- Use the Timer within the performance specified for water and oil exposure for each model.
- Do not use the Timer in locations subject to shock and vibration. Long-term usage in such locations may damage the Timer due to stress.  
Magnetic contactors generate a shock of 1,000 to 2,000 m/s<sup>2</sup> when switching a load. When mounting to DIN Track, separate magnetic contactors from the Timer so that the Timer is not subjected to vibration and shock. Use anti-vibration rubber.
- Do not use the Timer in locations subject to excessive dust, corrosive gases, or direct sunlight.
- Do not use organic solvents (such as paint thinner or benzine), strong alkalis, or strong acids because they will damage the external finish of the Timer.
- Separate the input devices, input wiring, and Timer as far as possible from sources of noise and power lines carrying noise.
- When using the Timer in environments subject to large amounts of static electricity (e.g., pipes carrying molding materials, powders, or fluid materials), separate the Timer as far as possible from the sources of static electricity.
- Do not remove the external case from the Timer.
- Do not use the Timer in locations where condensation may occur due to high humidity or sudden temperature changes.  
Condensation inside the Timer may result in malfunction or damage to Timer elements.
- The life of internal parts may be reduced if Timers are mounted in close proximity to each other.
- Resin and rubber parts (e.g., rubber packing) may deteriorate, shrink, or harden depending on the operating environment (e.g., subjected to corrosive gases, ultraviolet light, or high temperatures). We recommend periodic inspection and replacement.

- Normal operation may not be possible in locations subject to sulfidizing gas, such as in sewer systems or waste incinerators. OMRON does not market any Timers or other control devices for operation in atmospheres containing sulfidizing gas. Seal the Timer so that sulfidizing gas will not enter it. If sealing is not possible, OMRON does provide special Timers with improved resistance to sulfidizing gas. Ask your OMRON representative for details.

### Power Supply

- Be sure that the voltage applied is within the specified range, otherwise the internal elements of the Timer may be damaged.
- Install a switch or circuit breaker that allows the operator to immediately turn OFF the power, and label it to clearly indicate its function.
- Maintain voltage fluctuations in the power supply within the specified range.

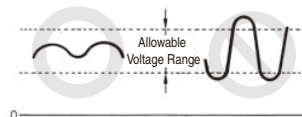

- Use a commercial power supply for the power supply voltage input to models with AC inputs.  
Inverters with an output frequency of 50/60 Hz are available, but the rise in the internal temperature of the Timer may result in ignition or burning. Do not use an inverter output for the power supply of the Timer.
- The Timers listed below cannot be directly turned ON and OFF by using an AC 2-wire proximity sensor to turn the Timer's power supply ON and OFF.  
Use the following countermeasure when using an AC 2-wire proximity sensor with the Timer. (The power supply circuit in the Timer uses half-wave rectification. Only a half AC wave is supplied to the proximity sensor, which may cause operation to be unstable.)

#### Applicable Models

H3Y, H3YN, H3RN, H3CA-8, RD2P, and H3CR(-A, -A8, -AP, -F, and -G)

#### Countermeasure

Wire through a relay and use the relay contacts to turn the power supply ON and OFF.

Confirm the stability of operation after making the connections.

- Install protective measures (such as earth leakage breakers, wiring breakers, or fuses) on the power supply side according to any applicable laws or regulations.

## Correctly Handling Input Signals

Malfunction due to noise may occur if input wiring is placed in the same duct or conduit as power lines or high-voltage lines. Separate input wiring from power lines and wire them in a separate system. Also, use shielded cables, use metal conduits, and keep wiring distances as short as possible.

## Timers with Relays

- Do not connect a load that exceeds contact ratings, such as the switching capacity (contact voltage or contact current). Insulation faults, contact welding, contact faults, and other failures to achieve specified performance may occur and the relay may be damaged or may burn.
- Continued use with deteriorated performance may ultimately result in insulation breakdown between circuits or relay burning. The life of the built-in relay is greatly affected by switching conditions. Before using the Timer, test operation under actual application conditions and confirm that the switching frequency presents no problems in performance.
- Electrical life depends on the type of load, switching frequency, and ambient environment. Observe the following precautions when using the Timer. When switching a DC load, contact transfer may cause the contacts to stick or may cause contact failure. Confirm applicability and consider using a surge absorbing element. When switching at high frequencies, heat generated by arcing may cause contacts to melt or may cause metal corrosion. Consider connecting an arc absorbing element, reducing the switching frequency, or lowering the humidity.
- The surge current depends on the type of load, which also affects contact switching frequency and the number of operations. Check the rated current and the surge current, and design the circuits with sufficient margin.

Resistive load	Solenoid load	Motor load	Incandescent lamp load
Rated current	10 to 20 times the rated current	5 to 10 times the rated current	10 to 20 times the rated current

Sodium light loads	Capacitor loads	Transformer loads	Mercury light loads
1 to 3 times the rated load	20 to 40 times the rated load	5 to 15 times the rated load	1 to 3 times the rated load

- Arcing when switching and relay heating may result in ignition or explosion. Do not use the Timer in atmospheres subject to inflammable or explosive gases.
- Contact faults may occur. Do not use the Timer in atmospheres subject to sulfidizing gas, chloride gas, or silicon gas.
- The switching capacity for DC voltage loads is lower than that for AC voltage loads.

## Timers with Non-contact Outputs

- Short faults or open faults may occur due to destruction of the output element. Do not use the Timer for a load that exceeds the rated output current.
- Short faults or open faults may occur due to destruction of the output element from reverse electromotive force. When using the Timer for a DC inductive load, always connect a diode as a countermeasure against reverse electromotive force.

## Other Precautions

- Confirm that you have the correct model before using it.
- Be sure that all terminals are wired correctly.
- Always test the output status with a tester before using a Timer with a built-in keep relay (e.g., the H3CR-H and H3DE-H). Shock resulting from dropping the Timer during transport or handling may cause the output contacts to reverse or to be in a neutral status.
- Leaving the Timer with outputs ON at a high temperature for a long time may hasten the degradation of internal parts (such as electrolytic capacitors). Use the Timer in combination with relays and avoid leaving the Timer with the output turned ON for an extended period of time (e.g., for more than a month). Reference Example (Use the Timer as shown below.)

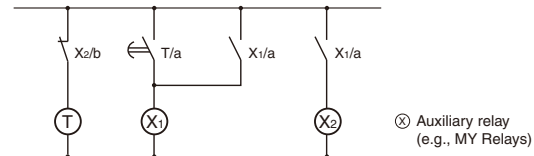

- Be sure that only a qualified worker (e.g., an electrical engineer) performs electrical work for the Timer.

ALL DIMENSIONS SHOWN ARE IN MILLIMETERS.

To convert millimeters into inches, multiply by 0.03937. To convert grams into ounces, multiply by 0.03527.

In the interest of product improvement, specifications are subject to change without notice.

## Read and Understand This Catalog

Please read and understand this catalog before purchasing the products. Please consult your OMRON representative if you have any questions or comments.

## Warranty and Limitations of Liability

### WARRANTY

OMRON's exclusive warranty is that the products are free from defects in materials and workmanship for a period of one year (or other period if specified) from date of sale by OMRON.

OMRON MAKES NO WARRANTY OR REPRESENTATION, EXPRESS OR IMPLIED, REGARDING NON-INFRINGEMENT, MERCHANTABILITY, OR FITNESS FOR PARTICULAR PURPOSE OF THE PRODUCTS. ANY BUYER OR USER ACKNOWLEDGES THAT THE BUYER OR USER ALONE HAS DETERMINED THAT THE PRODUCTS WILL SUITABLY MEET THE REQUIREMENTS OF THEIR INTENDED USE. OMRON DISCLAIMS ALL OTHER WARRANTIES, EXPRESS OR IMPLIED.

### LIMITATIONS OF LIABILITY

OMRON SHALL NOT BE RESPONSIBLE FOR SPECIAL, INDIRECT, OR CONSEQUENTIAL DAMAGES, LOSS OF PROFITS, OR COMMERCIAL LOSS IN ANY WAY CONNECTED WITH THE PRODUCTS, WHETHER SUCH CLAIM IS BASED ON CONTRACT, WARRANTY, NEGLIGENCE, OR STRICT LIABILITY.

In no event shall responsibility of OMRON for any act exceed the individual price of the product on which liability is asserted.

IN NO EVENT SHALL OMRON BE RESPONSIBLE FOR WARRANTY, REPAIR, OR OTHER CLAIMS REGARDING THE PRODUCTS UNLESS OMRON'S ANALYSIS CONFIRMS THAT THE PRODUCTS WERE PROPERLY HANDLED, STORED, INSTALLED, AND MAINTAINED AND NOT SUBJECT TO CONTAMINATION, ABUSE, MISUSE, OR INAPPROPRIATE MODIFICATION OR REPAIR.

## Application Considerations

### SUITABILITY FOR USE

OMRON shall not be responsible for conformity with any standards, codes, or regulations that apply to the combination of products in the customer's application or use of the product.

At the customer's request, OMRON will provide applicable third party certification documents identifying ratings and limitations of use that apply to the products. This information by itself is not sufficient for a complete determination of the suitability of the products in combination with the end product, machine, system, or other application or use.

The following are some examples of applications for which particular attention must be given. This is not intended to be an exhaustive list of all possible uses of the products, nor is it intended to imply that the uses listed may be suitable for the products:

- Outdoor use, uses involving potential chemical contamination or electrical interference, or conditions or uses not described in this catalog.
- Nuclear energy control systems, combustion systems, railroad systems, aviation systems, medical equipment, amusement machines, vehicles, safety equipment, and installations subject to separate industry or government regulations.
- Systems, machines, and equipment that could present a risk to life or property.

Please know and observe all prohibitions of use applicable to the products.

NEVER USE THE PRODUCTS FOR AN APPLICATION INVOLVING SERIOUS RISK TO LIFE OR PROPERTY WITHOUT ENSURING THAT THE SYSTEM AS A WHOLE HAS BEEN DESIGNED TO ADDRESS THE RISKS, AND THAT THE OMRON PRODUCT IS PROPERLY RATED AND INSTALLED FOR THE INTENDED USE WITHIN THE OVERALL EQUIPMENT OR SYSTEM.

## Disclaimers

### CHANGE IN SPECIFICATIONS

Product specifications and accessories may be changed at any time based on improvements and other reasons.

It is our practice to change model numbers when published ratings or features are changed, or when significant construction changes are made. However, some specifications of the product may be changed without any notice. When in doubt, special model numbers may be assigned to fix or establish key specifications for your application on your request. Please consult with your OMRON representative at any time to confirm actual specifications of purchased product.

### DIMENSIONS AND WEIGHTS

Dimensions and weights are nominal and are not to be used for manufacturing purposes, even when tolerances are shown.

### ERRORS AND OMISSIONS

The information in this catalog has been carefully checked and is believed to be accurate; however, no responsibility is assumed for clerical, typographical, or proofreading errors, or omissions.

### PERFORMANCE DATA

Performance data given in this catalog is provided as a guide for the user in determining suitability and does not constitute a warranty. It may represent the result of OMRON's test conditions, and the users must correlate it to actual application requirements. Actual performance is subject to the OMRON Warranty and Limitations of Liability.

### PROGRAMMABLE PRODUCTS

OMRON shall not be responsible for the user's programming of a programmable product, or any consequence thereof.

### COPYRIGHT AND COPY PERMISSION

This catalog shall not be copied for sales or promotions without permission.

This catalog is protected by copyright and is intended solely for use in conjunction with the product. Please notify us before copying or reproducing this catalog in any manner, for any other purpose. If copying or transmitting this catalog to another, please copy or transmit it in its entirety.