

**AMD GEODE™ GX2 CLOCK SOURCE**
**MK1491-09**
**Description**

The MK1491-09 is a low-cost, low-jitter, high-performance clock synthesizer for AMD's Geode-based computer and portable appliance applications. Using patented analog Phased-Locked Loop (PLL) techniques, the device accepts a 14.318 MHz crystal input to produce multiple output clocks. It provides selectable PCI local bus clocks, 48 MHz clocks for Super I/O and USB, as well as multiple Reference outputs.

The device has multiple power-down modes to reduce power consumption.

**Features**

- Packaged in 28-pin SSOP (209 mil body)
- Available in RoHS compliant package
- Provides all critical timing for the AMD Geode companion chip
- Four selectable PCI clocks
- Three LPC interface clocks
- One Fixed 66 MHz clock
- 2 Reference clocks
- 48 MHz USB and 48 MHz IO support
- Power down mode
- Low EMI Enable pin reduces EMI radiation on PCI clocks, LCLKS, and 66 MHz clock
- Operating voltage of 3.3 V  $\pm$ 5%
- Down Spread of 0.5% for PCI, LPC and 66 MHz clocks
- Industrial and commercial temperature ranges available

**NOTE: EOL for non-green parts to occur on 5/13/10 per PDN U-09-01**

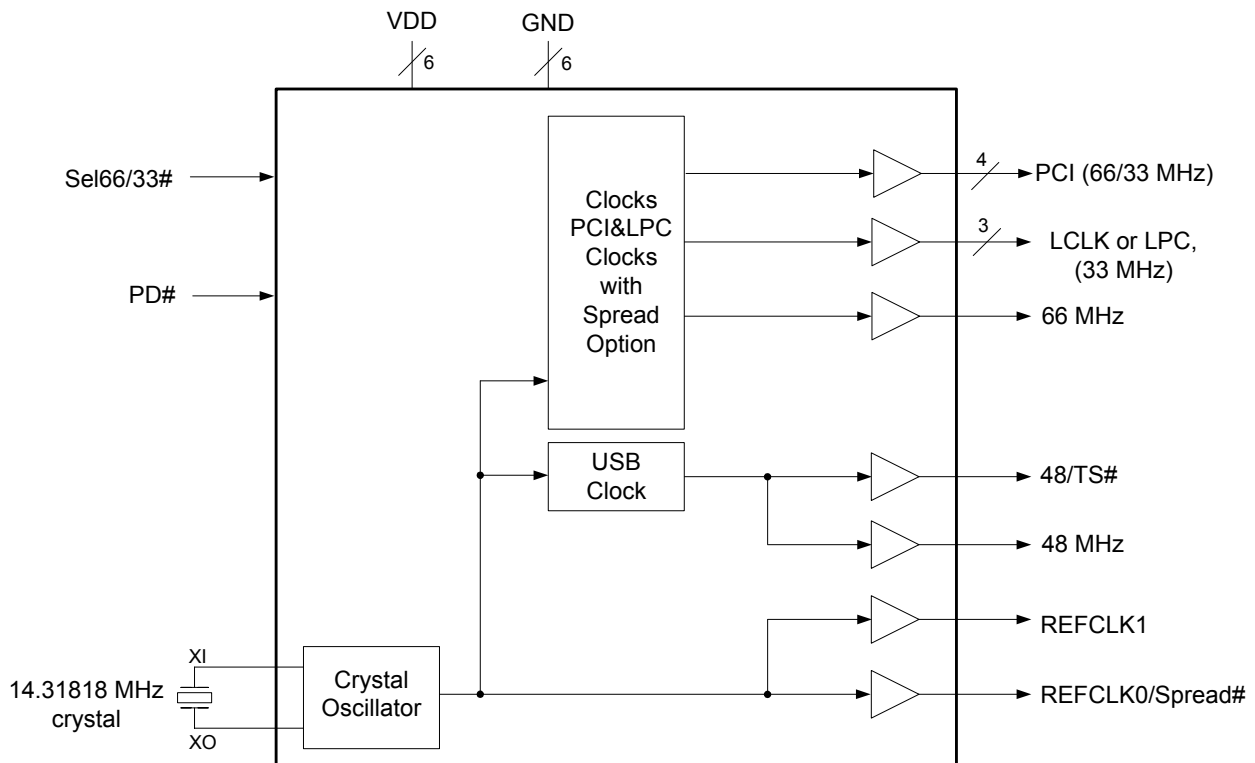
**Block Diagram**

## Pin Assignment

GND	<input type="checkbox"/>	1	28	<input type="checkbox"/>	VDD
XI	<input type="checkbox"/>	2	27	<input type="checkbox"/>	RefCLK0/Spread#
XO	<input type="checkbox"/>	3	26	<input type="checkbox"/>	RefCLK1
VDD	<input type="checkbox"/>	4	25	<input type="checkbox"/>	VDD
LCLK0/33M	<input type="checkbox"/>	5	24	<input type="checkbox"/>	PCICLK3/33-66M
LCLK1/33M	<input type="checkbox"/>	6	23	<input type="checkbox"/>	PCICLK2/33-66M
GND	<input type="checkbox"/>	7	22	<input type="checkbox"/>	GND
VDD	<input type="checkbox"/>	8	21	<input type="checkbox"/>	GND
LCLK2/33M	<input type="checkbox"/>	9	20	<input type="checkbox"/>	PCICLK1/33-66M
Sel66/33#	<input type="checkbox"/>	10	19	<input type="checkbox"/>	VDD
GND	<input type="checkbox"/>	11	18	<input type="checkbox"/>	PCICLK0/33-66M
VDD	<input type="checkbox"/>	12	17	<input type="checkbox"/>	PD#
48M	<input type="checkbox"/>	13	16	<input type="checkbox"/>	66M
48M/TS#	<input type="checkbox"/>	14	15	<input type="checkbox"/>	GND

## PCI Frequency Select Table

Sel66/33#	PCI Frequency
0	33 MHz
1	66 MHz

## EMI Control

Spread#	PCI, LPC and 66MHz Clocks	Down Spread amount
0	ON	-0.5%
1	OFF	0

Spread direction is DOWN.

## Pin Descriptions

Pin Number	Pin Name	Pin Type	Pin Description
1, 7, 11, 15, 21, 22	GND	P	Connect to Ground.
2	XI	I	Crystal connection. Connect to a 14.31818 MHz crystal or input clock.
3	XO	O	Crystal connection. Connect to a 14.31818 MHz crystal or leave unconnected.
4, 8, 12, 19, 25, 28	VDD	P	Connect to 3.3 V.
5, 6, 9	LPC or LCLK	O	33 MHz low skew clock outputs for LPC interface. These clocks are synchronous outputs with low skew.
10	Sel66/33#	I	When high, the PCICLK runs at 66 MHz; when low, the PCICLK runs at 33 MHz. This pin has a weak internal pull-up resistor. This is an active input, not a latched input.
13	48M	O	48 MHz clock output.
14	48M/TS#	I/O	48 MHz clock output. TS# is a latched input at power up and tristates all outputs when low upon power up. When high upon power up, all outputs are enabled. Power must be cycled for a change of state to be detected. This pin has a weak internal pull-up resistor.
16	66M	O	66 MHz clock output.
17	PD#	I	Power-down input. This is an active input not latched input. When this pin is set low, all clock outputs will be stopped, all PLL's will be stopped, and the oscillator will be powered off. Weak pull-up resistor (see Power Down table).
18, 20, 23, 24	PCICLK	O	33 to 66 MHz PCI synchronous clock outputs with low skew.
26	RefCLK1	O	Buffered reference output of 14.31818 MHz.
27	RefCLK0/ Spread#	I/O	Buffered reference output of 14.31818 MHz. Spread# is a latched input upon power up. Spread is applied to all clocks except REFCLK's and 48 MHz. Power must be cycled for a change of state to be detected. This pin has a weak internal pull-up resistor. See spread table.

**KEY:** I = Input, TI = Tri-level, O = Output, P = Power supply connection, (T)I/O = Input on power up, becomes an Output after 10 ms, Weak internal pull-up resistors are present on TS#, Spread#, PD#, and Sel66/33.

## Power Down Control Table

PD#	Functions
0	All clocks are stopped low.
1	All clocks are running.

## Power-on Default Conditions

Pin #	Function	Default	Condition
14	TS#	H	Latched input. All outputs enabled when high. When low, all outputs are in tristate.
27	Spread#	H	Latched input. Spread disabled when high. When low, spread is enabled on all outputs except ref clocks and 48 MHz.
10	Sel66/33#	H	This is an active input. When high, it selects PCI=66 MHz outputs; when low, selects PCI frequency = 33 MHz outputs.

## External Components

The MK1491-09 requires some inexpensive external components for proper operation. Decoupling capacitors of 0.1 $\mu$ F should be connected on each VDD pin to ground, as close to the MK1491-09 as possible. A series termination resistor of 33 $\Omega$  may be used for each clock output. See the discussion below for other external resistors required for proper I/O operation. The 14.318 MHz oscillator has internal caps that provide the proper load for a parallel resonant crystal with  $C_L=18$  pF. For tuning with other values of  $C_L$ , the formula  $2*(C_L-18)$  gives the value of each capacitor that should be connected between X1 and ground and X2 and ground.

## I/O Structure

The MK1491-09 provides more functionality in a 28-pin package by using a unique I/O technique. The device checks the status of all I/O pins during power-up. This status (pulled high or low) then determines the frequency selections and power down modes (see the tables on pages 2 and 3). Within 10ms after power up, the inputs change to outputs and the clocks start up. In the diagrams below, the 33 $\Omega$  resistors are the normal output termination resistors. The 10k $\Omega$  resistor pulls low to generate a logic zero when needed. Weak internal pull-up resistors are present on TS#, Spread#, PD#, and Sel66/33 to pull the pin to high when left floating.

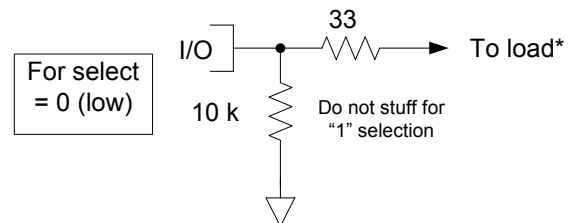

\*Note: Do not use a TTL load. This will overcome the 10 k $\Omega$  pull-down and force the input to a logic 1.

## Absolute Maximum Ratings

Stresses above the ratings listed below can cause permanent damage to the MK1491-09. These ratings, which are standard values for IDT commercially rated parts, are stress ratings only. Functional operation of the device at these or any other conditions above those indicated in the operational sections of the specifications is not implied. Exposure to absolute maximum rating conditions for extended periods can affect product reliability. Electrical parameters are guaranteed only over the recommended operating temperature range.

Item	Rating
Supply Voltage, VDD (referenced to VSS)	4.6 V
All Inputs and Outputs (referenced to VSS)	-0.5 V to VDD+0.5 V
Ambient Operating Temperature (commercial)	0 to +70° C
Ambient Operating Temperature (industrial)	-40 to +85° C
Storage Temperature	-65 to +150° C
Junction Temperature	125° C
Soldering Temperature (10 seconds max)	260° C
Spread Spectrum Enabled for PCI and LPC Clocks	30 kHz min., 33 kHz max.

## DC Electrical Characteristics

Unless stated otherwise, **VDD = 3.3 V**, Ambient Temp. 0 to +70° C (commercial); -40 to 85° C (industrial)

Parameter	Symbol	Conditions	Min.	Typ.	Max.	Units
Operating Voltage	VDD		3.13	3.3	3.46	V
Input High Voltage	V <sub>IH</sub>		2		VDD	V
Input Low Voltage	V <sub>IL</sub>		VSS		0.8	V
Output High Voltage	V <sub>OH</sub>	I <sub>OH</sub> = -12 mA	2.4			V
Output Low Voltage	V <sub>OL</sub>	I <sub>OL</sub> = 12 mA			0.4	V
Operating Supply Current	IDD	VDD = 3.3 V			60	mA
Clock Disable Mode Supply Current					0.5	mA
Internal Pull-up Resistor		All inputs except XI		120		kΩ
Input Capacitance	C <sub>IN</sub>	All inputs except XI		5		pF
Spread Spectrum Modulation Rate	f <sub>mod</sub>	Enabled for PCI and LPC Clocks	30		33	KHz

## AC Electrical Characteristics

Unless stated otherwise, **VDD = 3.3 V**, Ambient Temp. 0 to +70° C (commercial); -40 to 85° C (industrial),  $C_L=30\text{pF}$

Parameter	Symbol	Conditions	Min.	Typ.	Max.	Units
Input Frequency	$F_{IN}$			14.31818		MHz
Output Clock Skew Rate (PCI and LPC), load=30 pF		Between 0.4 V and 2.4 V			4	V/ns
Output Clock Rise and Fall Time (all but PCI and LPC), load=30 pF	$t_{OR}, t_{OF}$	Between 0.4 V and 2.4 V	0.5		2	ns
Output Clock Duty Cycle, all MHz Clocks	$t_{OD}$	At 1.5 V	40		60	%
PCI Output to Output Skew, at 33 MHz		Rising edges at 1.5 V			500	ps
PCI Output to Output Skew, at 66 MHz		Rising edges at 1.5 V			250	ps
LPC Output to Output Skew		Rising edges at 1.5 V			500	ps
PCI to LPC Output to Output Skew (note 1)		Rising edge at 1.5 V			500	ps
Cycle-to-Cycle Jitter, PCICLK					300	ps
Cycle-to-Cycle Jitter, LPCCLK					500	ps
Cycle-to-Cycle Jitter, USBCLK and 48 MHz					500	ps
Cycle-to-Cycle Jitter, REFCLK's					1400	ps
Power-on Time, applied VDD to all Clocks Stable					5	ms
Load Capacitance Crystal				18	30	pF

Note 1: Only valid when PCI is at 33 MHz.

## Thermal Characteristics

Parameter	Symbol	Conditions	Min.	Typ.	Max.	Units
Thermal Resistance Junction to Ambient	$\theta_{JA}$	Still air		100		°C/W
	$\theta_{JA}$	1 m/s air flow		80		°C/W
	$\theta_{JA}$	3 m/s air flow		67		°C/W
Thermal Resistance Junction to Case	$\theta_{JC}$			60		°C/W

## Marking Diagram (MK1491-09F)

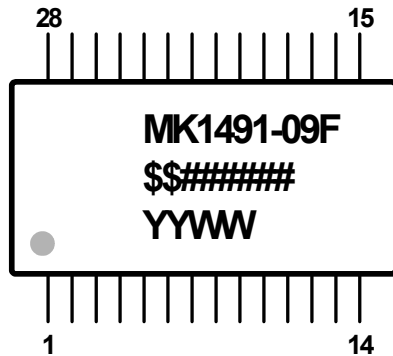

## Marking Diagram (MK1491-09FI)

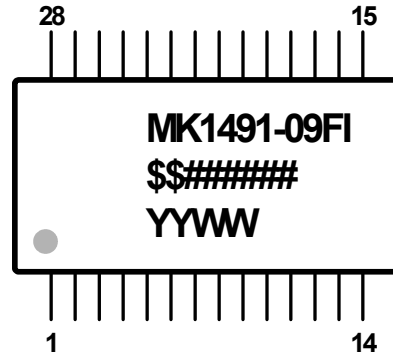

## Marking Diagram (MK1491-09FLN)

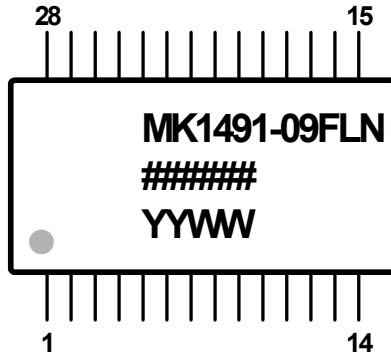

## Marking Diagram (MK1491-09FILN)

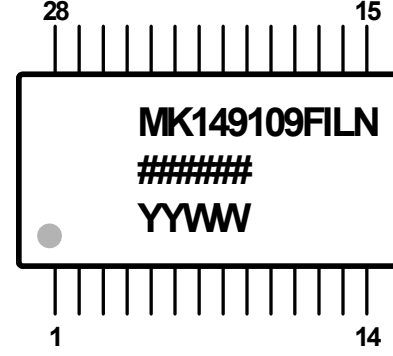

## Notes:

1. ##### is the lot code.
2. YYWW is the last two digits of the year, and the week number that the part was assembled.
3. "LN" designates RoHS compliant package.
4. "I" designates industrial temperature grade.
5. Bottom marking: country of origin if not USA.

## Package Outline and Package Dimensions (28-pin SSOP, 209 mil Body)

Package dimensions are kept current with JEDEC Publication No. 95, MO-150

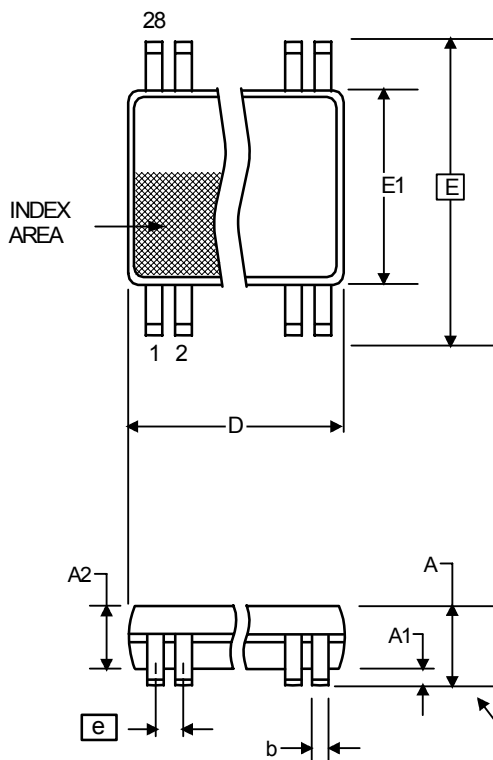

Symbol	Millimeters		Inches*	
	Min	Max	Min	Max
A	—	2.00	—	0.079
A1	0.05	—	0.002	—
A2	1.65	1.85	0.065	0.073
b	0.22	0.38	0.009	0.015
c	0.09	0.25	0.0035	0.010
D	9.90	10.50	0.390	0.413
E	7.40	8.20	0.291	0.323
E1	5.00	5.60	0.197	0.220
e	0.65 Basic		0.0256 Basic	
L	0.55	0.95	0.022	0.037
$\alpha$	0°	8°	0°	8°

\*For reference only. Controlling dimensions in mm.

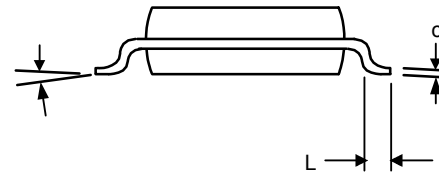

## Ordering Information

Part / Order Number	Marking	Low EMI Feature	Shipping Packaging	Package	Temperature
MK1491-09F*	see page 7	Yes	Tubes	28-pin SSOP	0 to +70° C
MK1491-09FTR*		Yes	Tape and Reel	28-pin SSOP	0 to +70° C
MK1491-09FLN		Yes	Tubes	28-pin SSOP	0 to +70° C
MK1491-09FLNTR		Yes	Tape and Reel	28-pin SSOP	0 to +70° C
MK1491-09FI*	see page 7	Yes	Tubes	28-pin SSOP	-40 to +85° C
MK1491-09FITR*		Yes	Tape and Reel	28-pin SSOP	-40 to +85° C
MK1491-09FILN		Yes	Tubes	28-pin SSOP	-40 to +85° C
MK1491-09FILNTR		Yes	Tape and Reel	28-pin SSOP	-40 to +85° C

\*NOTE: EOL for non-green parts to occur on 5/13/10 per PDN U-09-01

Parts that are ordered with a "LN" suffix to the part number are the Pb-Free configuration and are RoHS compliant.

While the information presented herein has been checked for both accuracy and reliability, Integrated Device Technology (IDT) assumes no responsibility for either its use or for the infringement of any patents or other rights of third parties, which would result from its use. No other circuits, patents, or licenses are implied. This product is intended for use in normal commercial applications. Any other applications such as those requiring extended temperature range, high reliability, or other extraordinary environmental requirements are not recommended without additional processing by IDT. IDT reserves the right to change any circuitry or specifications without notice. IDT does not authorize or warrant any IDT product for use in life support devices or critical medical instruments.



## Revision History

Rev.	Originator	Date	Description of Change
F	S.Gardner	06/23/04	Corrected pitch dimension on package diagram.
G	S.Gardner	08/02/04	Added LF.
H	A.Ilkbahar	01/11/06	Changed units from “ns” to “ps” for “ <i>PCI to LPC Output to Output Skew</i> ” spec in AC char table
I	J.Sarma	02/15/06	Updates to Block Diagram; corrections and additions to Pin Descriptions; updates to EMI Control table; updated Power Default table; updates to AC table.
J	J.Sarma	07/05/06	Corrections to device markings/diagrams.
K	R.Willner	07/24/06	Added industrial temperature range markings and ordering info.
L		12/18/09	Added EOL note for non-green parts.

**Innovate with IDT and accelerate your future networks. Contact:**

**www.IDT.com**

**For Sales**

800-345-7015  
408-284-8200  
Fax: 408-284-2775

**For Tech Support**

[www.idt.com/go/clockhelp](http://www.idt.com/go/clockhelp)

---

**Corporate Headquarters**

Integrated Device Technology, Inc.  
[www.idt.com](http://www.idt.com)



[www.IDT.com](http://www.IDT.com)