

STEP-Z Interconnection System (Continued)

25.00 [.984] Plugs

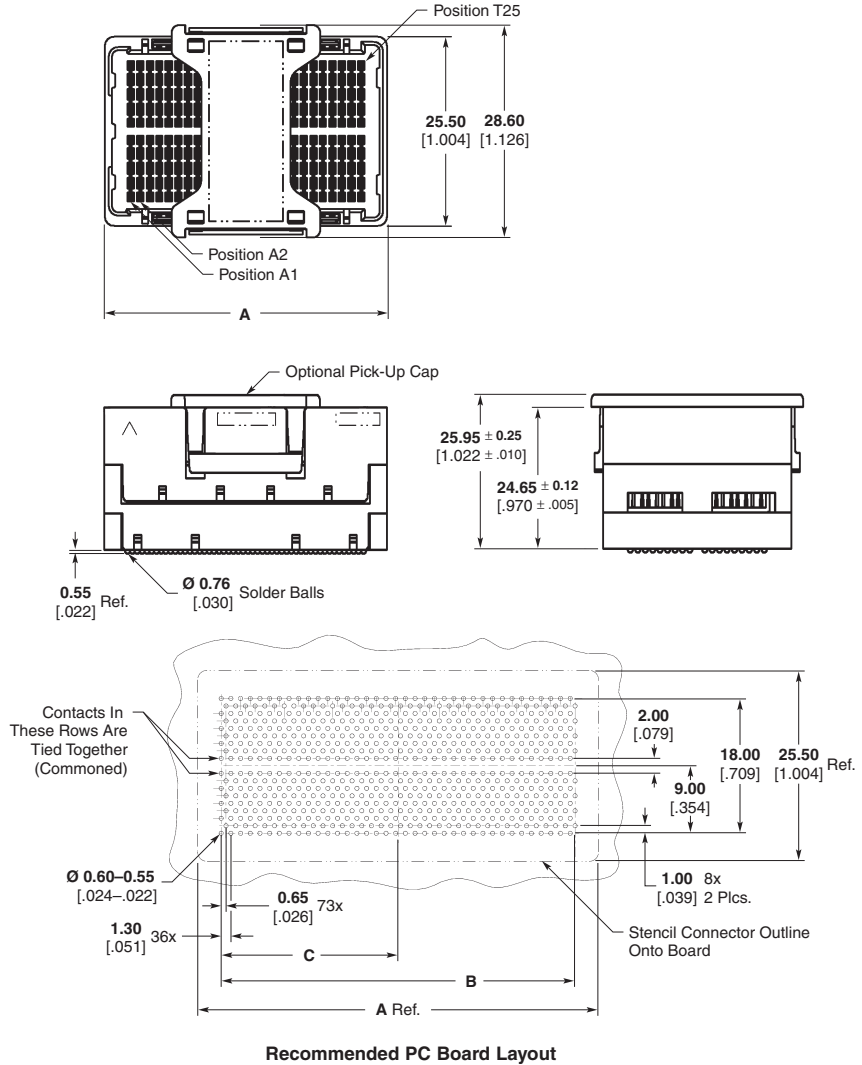

No. of Pos.*	Dimensions			Plating	Part Numbers
	A	B	C		With Pick & Place Cap
200	38.20	31.85	15.93	SnPb	2-1761614-5◆
	1.504	1.254	.627	Pb-free	7-1761614-5
296	53.75	47.45	23.725	SnPb	2-1761616-5◆
	2.116	1.868	.934	Pb-free	7-1761616-5

* Signal contacts only, ground contacts not included.
Tray packaged Part Numbers shown. Contact Tyco Electronics Engineering for Tape and Reel packaged versions.

Note: Part Numbers are RoHS compliant except: ◆ Indicates non-RoHS compliant;
● Indicates "5 of 6 compliant" (lead in solderable interface only).

Introduction to the MICTOR Interconnection System (0.64 [.025] Centerline)

Product Facts

- 76 dedicated signal lines per linear inch
- Surface mount family designed for parallel and right-angle board-to-board, flex-to-board and cable-to-board configurations
- 0.64 [.025] centerline contact spacing
- Redundant interfaces on mated contacts
- Fifteen mated stack heights available ranging from 6.60 [.260] to 31.90 [1.256]
- Infrared and forced air convection compatible housing materials
- Designed for 50-ohm systems
- Connector housings polarized for correct mating
- Built-in connector-to-board retention feature
- Connector can be separated by peeling from one end to the other
- Various packaging styles can be made available for automated assembly (tape and reel, tubes)
- Recognized under the Component Program of Underwriter Laboratories Inc.  File No. E28476



The MICTOR connector family is based on the microstrip concept of two rows of signal contacts divided by a center power ground plane. MICTOR connectors are mother-board and daughtercard compatible and include designs for cable-to-board applications.

Various mated heights are available for parallel board-to-board systems. Custom stacking heights can be

provided. The MICTOR connector family is available in 0.64 [.025] centerlines and in sizes ranging from 38 signal positions to 266 positions (in increments of 38 positions). There is a discrete ground bus every 12.7 [.50] of the connector length, which can be assigned to either power or ground in any combination.

Redundant interfaces on every signal line provide added reliability. Two plating

options are available to meet the needs of various applications.

The housing material is a liquid crystal polymer, compatible with infrared and forced air convection operations.

The connector system uses the solid ground bus between the rows of signals to provide low crosstalk and excellent high-speed signal characteristics.

MICTOR Connector Cross Section



MICTOR
Interconnection System

Connectors are shown at point where signal contact first touch each other.

Connectors are designed to be fully mated when the two "Z" datums meet.

- Green** = Receptacle housing
- Red** = Plug housing
- Blue** = Signal contacts
- Brown** = Ground bus contacts

Material and Performance Specifications, MICTOR Connectors

Material Specifications

Material

Housing — Liquid crystal polymer, black

Contacts — High reliability copper alloy

Ground Bus — Phosphor bronze

Finish (Gold Plating)

Contacts and Ground Bus — Duplex plated 0.00076 [.000030] min. gold in mating area, 0.00381 [.000150] min. tin-lead on leads, with entire contact and ground bus underplated 0.00178 [.000070] min. nickel

Finish (Palladium-Nickel Plating)

Contacts and Ground Bus — Duplex plated 0.000013 [.000005] min. gold over 0.00076 [.000030] min. palladium-nickel in mating area, 0.00381 [.000150] min. tin-lead on leads, with entire contact and ground bus underplated 0.00178 [.000070] min. nickel

Finish (Lead-Free Plating)

Contacts and Ground Bus — 0.00076 [.000030] min. gold on contact area, 0.00381-0.00635 [.000150-.000250] matte tin per ASTM B 545 on leads, all over 0.00177-0.00445 [.000070-.000175] nickel.

Or

0.00013 [.000005] min. gold over, 0.00076 [.000030] min. palladium nickel on contact area, 0.00381-0.00635 [.000150-.000250] matte tin per ASTM B 545 on leads, all over 0.00191-0.00445 [.000075-.000175] nickel.

Performance Specifications

Ratings

Voltage — 30 vac

Current — Signal; rated 1.0 Amps, fully derated 0.5 Amps
Ground; rated 11.5 Amps, fully derated 7.6 Amps

Temperature — -55°C to +125°C

Electrical Characteristics

Characteristic Impedance — 50±5 ohms at 1 ns

Termination Resistance — ΔR 10 milliohms max.; Specification 109-6-1

Insulation Resistance — 10,000 megohms min.; Specification 109-208-1

Dielectric Withstanding Voltage — 500 vac at sea level; Specification 109-29-1

Mechanical Characteristics

Solderability — Solderable area shall have a 95% min. solder coverage; Specification 109-11-1

Vibration (Random) — No discontinuities of 1 μs or longer duration; Specification 109-21-5

Physical Shock — No discontinuities of 1 μs or longer duration; Specification 109-26-1

Durability (Tested to) — Mate and unmate samples at a rate of 600 cycles max. per hour. 25 cycles, gold plating; 500 cycles, palladium-nickel plating; Specification 109-27

Contact Retention — 1 lb min.; Specification 109-30

Mating Force — 152 oz max. per 1/2 inch of connector (1 module). Each module equals 38 signal contacts and 1 ground bus; Specification 109-42

Unmating Force — 19 oz min. per 1/2 inch of connector (1 module). Each module equals 38 signal contacts and 1 ground bus; Specification 109-42

Environmental Characteristics

Thermal Shock — Subject mated samples to 5 cycles between -55°C and +125°C; Specification 109-22

Humidity - Temperature Cycling — Subject mated samples to 10 cycles between +25°C and +65°C at 95% RH; Specification 109-23-3, Condition B

Temperature Cycling — Subject mated samples to 1024 cycles between -40°C and +60°C at 2 hours per cycle; Specification 109-75-1

Temperature Life — Subject mated samples to temperature life at +118°C for 792 hours; Specification 109-43

Mixed Flowing Gas — Subject mated samples to environmental class II for 14 days; Specification 109-85-2

MICTOR Stack Height Combinations

**30 μ Gold and Palladium
Nickel Plated Vertical
Connectors**



6.60 [.260] Plug
(Pages 19 and 20)
Standard Receptacle
(Pages 36 and 37)



9.00 [.354] Plug
(Pages 21 and 22)
Standard Receptacle
(Pages 36 and 37)



11.00 [.430] Plug
(Pages 23 and 24)
Standard Receptacle
(Pages 36 and 37)

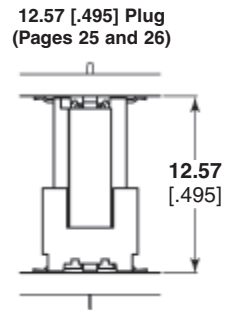

12.57 [.495] Plug
(Pages 25 and 26)
Standard Receptacle
(Pages 36 and 37)

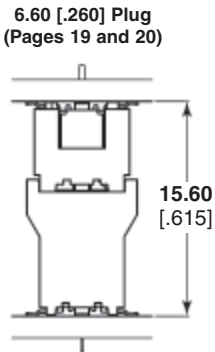

6.60 [.260] Plug
(Pages 19 and 20)
Raised Receptacle
(Pages 38 and 39)



9.00 [.354] Plug
(Pages 21 and 22)
Raised Receptacle
(Pages 38 and 39)



18.75 [.738] Plug
(Page 29)
Standard Receptacle
(Pages 36 and 37)



11.00 [.430] Plug
(Pages 23 and 24)
Raised Receptacle
(Pages 38 and 39)

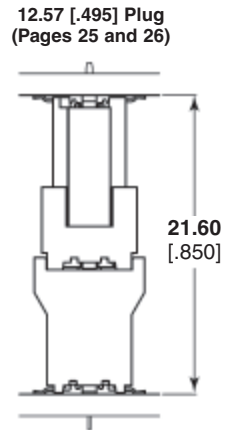

12.57 [.495] Plug
(Pages 25 and 26)
Raised Receptacle
(Pages 38 and 39)

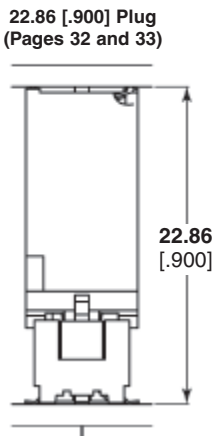

22.86 [.900] Plug
(Pages 32 and 33)
Standard Receptacle
(Pages 36 and 37)



17.96 [.707] Plug
(Pages 27 and 28)
Raised Receptacle
(Pages 38 and 39)



18.75 [.738] Plug*
(Page 29)
Raised Receptacle
(Pages 38 and 39)



20.00 [.785] Plug*
(Pages 30 and 31)
Raised Receptacle
(Pages 38 and 39)

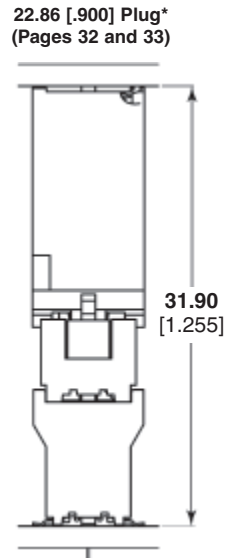

22.86 [.900] Plug*
(Pages 32 and 33)
Raised Receptacle
(Pages 38 and 39)

*This connector not available in Palladium Nickel.

MICTOR Right-Angle (Straddle Mount) Combinations

30 μ Gold & Palladium
Nickel Connections

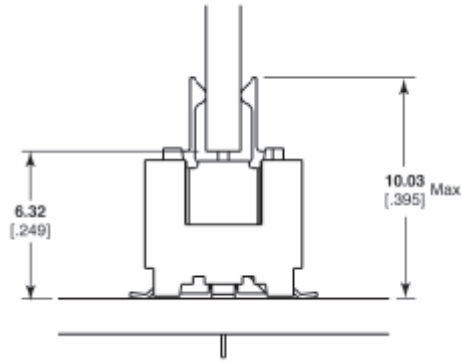

Vertical Receptacle with
Right-Angle Plug

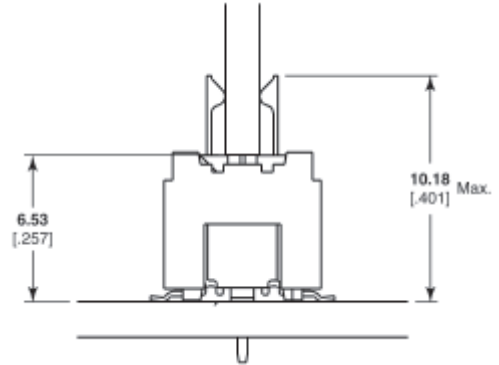

Vertical Plug with
Right-Angle Receptacle

Right-angle versions are designed for paddlecard type applications. It is highly recommended that customers who are considering right-angle applications contact Tyco Electronics

Engineering to review their applications as the potential for tolerancing issues and/or issues of solder joint integrity can be highly application specific.

MICTOR Vertical Plugs

**6.60 [.260]
Stacking Height***

Related Product Data

Material and Finish — page 16

Performance Characteristics — page 16

Mating Receptacles — pages 36-41

Technical Documents — page 81

*6.60 [.260] stack height when mated to vertical receptacle;
15.62 [.615] stack height when mated to vertical receptacle (extended height).

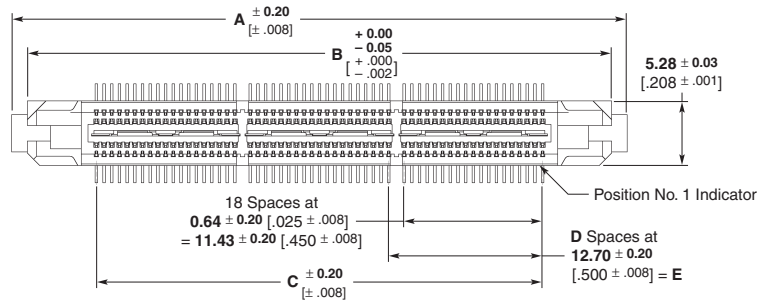

**Recommended PC Board Layout
(Viewed from Connector Side)**

Note: For standard applications, the orientation hole must be 2.39±0.05 [.094±.002]; For slip-fit applications, the orientation hole must be 2.00±0.03 [.079±.001].

MICTOR Vertical Plugs (Continued)

6.60 [.260] Stacking Height (Continued)

No. of Pos.	Dimensions						Platings		Part Numbers												
	A	B	C	D	E	F	Solder Tail	Contact	Barbed G/B Leads			Barbless G/B Leads									
									Tube	T&R Vacuum Caps		Tube	T&R Vacuum Caps								
							With			Without			With		Without						
38	25.40 1.000	22.81 .898	11.43 .450	0	—	1.35 [.053]	SnPb	Gold	767007-8♦	767111-8♦	767111-1♦	767116-1♦	767118-1♦	767118-8♦							
						2.72 [.107]		PdNi	767056-1♦	—	—	—	—	—							
						2.64 [.104]		—	—	—	767117-1♦	767119-1♦	767119-8♦								
						1.35 [.053]		Gold	5767007-8	5767111-8	5767111-1	5767116-1	5767118-1	5767118-8							
						2.72 [.107]	Pb-free	PdNi	5767056-1	—	—	—	—	—							
						2.64 [.104]		—	—	—	5767117-1	5767119-1	5767119-8								
						76		38.10 1.500	31.70 1.248	24.13 .950	1	12.70 .500	1.35 [.053]	SnPb	Gold	767007-9♦	767111-9♦	767111-2♦	767116-2♦	767118-2♦	767118-9♦
													2.72 [.107]		PdNi	767056-2♦	—	—	—	—	—
2.64 [.104]	—	—	—	767117-2♦	767119-2♦		767119-9♦														
1.35 [.053]	Gold	5767007-9	5767111-9	5767111-2	5767116-2		5767118-2						5767118-9								
2.72 [.107]	Pb-free	PdNi	5767056-2	—	—		—						—	—							
2.64 [.104]		—	—	—	5767117-2		5767119-2						5767119-9								
114		50.80 2.000	48.21 1.898	36.83 1.450	2		25.40 1.000						1.35 [.053]	SnPb	Gold	1-767007-0♦	1-767111-0♦	767111-3♦	767116-3♦	767118-3♦	1-767118-0♦
													2.72 [.107]		PdNi	767056-3♦	—	—	—	—	—
	2.64 [.104]					—		—	—	767117-3♦	767119-3♦	1-767119-0♦									
	1.35 [.053]					Gold		1-5767007-0	1-5767111-0	5767111-3	5767116-3	5767118-3	1-5767118-0								
	2.72 [.107]					Pb-free		PdNi	5767056-3	—	—	—	—	—							
	2.64 [.104]							—	—	—	5767117-3	5767119-3	1-5767119-0								
	152							63.50 2.500	60.91 2.398	49.53 1.950	3	38.10 1.500	1.35 [.053]	SnPb	Gold	1-767007-1♦	1-767111-1♦	767111-4♦	767116-4♦	767118-4♦	1-767118-1♦
													2.72 [.107]		PdNi	767056-4♦	—	—	—	—	—
2.64 [.104]		—	—	—	767117-4♦	767119-4♦	1-767119-1♦														
1.35 [.053]		Gold	1-5767007-1	1-5767111-1	5767111-4	5767116-4	5767118-4						1-5767118-1								
2.72 [.107]		Pb-free	PdNi	5767056-4	—	—	—						—	—							
2.64 [.104]			—	—	—	5767117-4	5767119-4						1-5767119-1								
190			76.20 3.000	73.61 2.898	62.23 2.450	4	50.80 2.000						1.35 [.053]	SnPb	Gold	1-767007-2♦	1-767111-2♦	767111-5♦	767116-5♦	767118-5♦	1-767118-2♦
													2.72 [.107]		PdNi	767056-5♦	—	—	—	—	—
	2.64 [.104]	—						—	—	767117-5♦	767119-5♦	1-767119-2♦									
	1.35 [.053]	Gold						1-5767007-2	1-5767111-2	5767111-5	5767116-5	5767118-5	1-5767118-2								
	2.72 [.107]	Pb-free						PdNi	5767056-5	—	—	—	—	—							
	2.64 [.104]							—	—	—	5767117-5	5767119-5	1-5767119-2								
	228							88.90 3.500	86.31 3.398	74.93 2.950	5	63.50 2.500	1.35 [.053]	SnPb	Gold	1-767007-3♦	—	—	767116-6♦	—	—
													2.72 [.107]		PdNi	767056-6♦	—	—	—	—	—
2.64 [.104]		—	—	—	767117-6♦	—	—														
1.35 [.053]		Gold	1-5767007-3	—	—	5767116-6	—						—								
2.72 [.107]		Pb-free	PdNi	5767056-6	—	—	—						—	—							
2.64 [.104]			—	—	—	5767117-6	—						—								
266			101.60 4.000	99.01 3.898	87.63 3.450	6	76.20 3.000						1.35 [.053]	SnPb	Gold	1-767007-4♦	—	—	767116-7♦	—	—
													2.72 [.107]		PdNi	767056-7♦	—	—	—	—	—
	2.64 [.104]	—						—	—	767117-7♦	—	—									
	1.35 [.053]	Gold						1-5767007-4	—	—	5767116-7	—	—								
	2.72 [.107]	Pb-free						PdNi	5767056-7	—	—	—	—	—							
	2.64 [.104]							—	—	—	5767117-7	—	—								

Notes: 1. Contact Product Engineering regarding options not present in this table.
2. T&R vacuum caps are placed on some connectors to allow them to be picked up with robotic placement equipment that uses vacuum pick-up nozzles.

Note: Part Numbers are RoHS compliant except: ♦ Indicates non-RoHS compliant;
● Indicates "5 of 6 compliant" (lead in solderable interface only).

MICTOR Vertical Plugs (Continued)

**9.00 [.354]
Stacking Height***

Related Product Data

Material and Finish — page 16

Performance Characteristics — page 16

Mating Receptacles — pages 36-41

Technical Documents — page 81

* 9.00 [.354] stack height when mated to vertical receptacle;
18.00 [.709] stack height when mated to vertical receptacle (extended height).



**Recommended PC Board Layout
(Viewed from Connector Side)**

Note: For standard applications, the orientation hole must be 2.39±0.05 [.094±.002]; For slip-fit applications, the orientation hole must be 2.00±0.03 [.079±.001].

MICTOR Vertical Plugs (Continued)

9.00 [.354] Stacking Height (Continued)

No. of Pos.	Dimensions						Platings		Part Numbers
	A	B	C	D	E	F	Solder Tail	Contact	Barbed G/B Leads
									Tube
38	25.40 1.000	22.81 .898	11.43 .450	0	—	1.52 [.060]	SnPb	Gold	767139-1◆
						2.74 [.108]			PdNi
						1.52 [.060]	Pb-free	Gold	5767139-1
						2.74 [.108]			PdNi
76	38.10 1.500	31.70 1.248	24.13 .950	1	12.70 .500	1.52 [.060]	SnPb	Gold	767139-2◆
						2.74 [.108]			PdNi
						1.52 [.060]	Pb-free	Gold	5767139-2
						2.74 [.108]			PdNi
114	50.80 2.000	48.21 1.898	36.83 1.450	2	25.40 1.000	1.52 [.060]	SnPb	Gold	767139-3◆
						2.74 [.108]			PdNi
						1.52 [.060]	Pb-free	Gold	5767139-3
						2.74 [.108]			PdNi
152	63.50 2.500	60.91 2.398	49.53 1.950	3	38.10 1.500	1.52 [.060]	SnPb	Gold	767139-4◆
						2.74 [.108]			PdNi
						1.52 [.060]	Pb-free	Gold	5767139-4
						2.74 [.108]			PdNi
190	76.20 3.000	73.61 2.898	62.23 2.450	4	50.80 2.000	1.52 [.060]	SnPb	Gold	767139-5◆
						2.74 [.108]			PdNi
						1.52 [.060]	Pb-free	Gold	5767139-5
						2.74 [.108]			PdNi
228	88.90 3.500	86.31 3.398	74.93 2.950	5	63.50 2.500	1.52 [.060]	SnPb	Gold	767139-6◆
						2.74 [.108]			PdNi
						1.52 [.060]	Pb-free	Gold	5767139-6
						2.74 [.108]			PdNi
266	101.60 4.000	99.01 3.898	87.63 3.450	6	76.20 3.000	1.52 [.060]	SnPb	Gold	767139-7◆
						2.74 [.108]			PdNi
						1.52 [.060]	Pb-free	Gold	5767139-7
						2.74 [.108]			PdNi

Note: Part Numbers are RoHS compliant except: ◆ Indicates non-RoHS compliant;
● Indicates "5 of 6 compliant" (lead in solderable interface only).

MICTOR Vertical Plugs (Continued)

**11.00 [.430]
Stacking Height***

Related Product Data

Material and Finish — page 16

Performance Characteristics — page 16

Mating Receptacles — pages 36-41

Technical Documents — page 81

* 11.00 [.430] stack height when mated to vertical receptacle;
19.94 [.785] stack height when mated to vertical receptacle (extended height).



**Recommended PC Board Layout
(Viewed from Connector Side)**

Note: For standard applications, the orientation hole must be 2.39±0.05 [.094±.002]; For slip-fit applications, the orientation hole must be 2.00±0.03 [.079±.001].

MICTOR Vertical Plugs (Continued)

11.00 [.430] Stacking Height (Continued)

No. of Pos.	Dimensions						Platings		Part Numbers				
	A	B	C	D	E	F	Solder Tail	Contact	Barbed G/B Leads		Barbless G/B Leads		
									Tube	T&R Vacuum Caps		Tube	T&R Vacuum Caps
										With	Without		
38	25.40 1.000	22.81 .898	11.43 .450	0	—	1.52 [.060]	SnPb	Gold	767003-9●	767123-8●	767123-1●	—	—
						2.64 [.104]			PdNi	767087-1●	—	—	—
						1.52 [.060]	Pb-free	Gold	5767003-9	5767123-8	5767123-1	—	—
						2.64 [.104]			PdNi	5767087-1	—	—	—
76	38.10 1.500	31.70 1.248	24.13 .950	1	12.70 .500	1.52 [.060]	SnPb	Gold	1-767003-0●	767123-9●	767123-2●	—	—
						2.64 [.104]			PdNi	767087-2●	—	—	—
						1.52 [.060]	Pb-free	Gold	1-5767003-0	5767123-9	5767123-2	—	—
						2.64 [.104]			PdNi	5767087-2	—	—	—
114	50.80 2.000	48.21 1.898	36.83 1.450	2	25.40 1.000	1.52 [.060]	SnPb	Gold	1-767003-1●	1-767123-0●	767123-3●	1-767182-3●	1-767183-0●
						2.64 [.104]			PdNi	767087-3●	—	—	—
						1.52 [.060]	Pb-free	Gold	1-5767003-1	1-5767123-0	5767123-3	1-5767182-3	1-5767183-0
						2.64 [.104]			PdNi	5767087-3	—	—	—
152	63.50 2.500	60.91 2.398	49.53 1.950	3	38.10 1.500	1.52 [.060]	SnPb	Gold	767003-8●	—	—	—	—
						2.64 [.104]			PdNi	767087-4●	—	—	—
						1.52 [.060]	Pb-free	Gold	5767003-8	—	—	—	—
						2.64 [.104]			PdNi	5767087-4	—	—	—
190	76.20 3.000	73.61 2.898	62.23 2.450	4	50.80 2.000	1.52 [.060]	SnPb	Gold	1-767003-2●	1-767123-2●	767123-5●	—	—
						2.64 [.104]			PdNi	767087-5●	—	—	—
						1.52 [.060]	Pb-free	Gold	1-5767003-2	1-5767123-2	5767123-5	—	—
						2.64 [.104]			PdNi	5767087-5	—	—	—
228	88.90 3.500	86.31 3.398	74.93 2.950	5	63.50 2.500	1.52 [.060]	SnPb	Gold	1-767003-3●	—	—	—	—
						2.64 [.104]			PdNi	767087-6●	—	—	—
						1.52 [.060]	Pb-free	Gold	1-5767003-3	—	—	—	—
						2.64 [.104]			PdNi	5767087-6	—	—	—
266	101.60 4.000	99.01 3.898	87.63 3.450	6	76.20 3.000	1.52 [.060]	SnPb	Gold	1-767003-4●	—	—	—	—
						2.64 [.104]			PdNi	767087-7●	—	—	—
						1.52 [.060]	Pb-free	Gold	1-5767003-4	—	—	—	—
						2.64 [.104]			PdNi	5767087-7	—	—	—

Note: Contact Product Engineering regarding options not present in this table.

Note: Part Numbers are RoHS compliant except: ♦ Indicates non-RoHS compliant;
● Indicates "5 of 6 compliant" (lead in solderable interface only).

MICTOR Vertical Plugs (Continued)

**12.57 [.495]
Stacking Height***

Related Product Data

Material and Finish — page 16

Performance Characteristics — page 16

Mating Receptacles — pages 36-41

Technical Documents — page 81

* 12.57 [.495] stack height when mated to vertical receptacle;
21.59 [.850] stack height when mated to vertical receptacle (extended height).



**Recommended PC Board Layout
(Viewed from Connector Side)**

Note: For standard applications, the orientation hole must be 2.39±0.05 [.094±.002]; For slip-fit applications, the orientation hole must be 2.00±0.03 [.079±.001].

MICTOR Vertical Plugs (Continued)

12.57 [.495] Stacking Height (Continued)

No. of Pos.	Dimensions						Platings		Part Numbers						
	A	B	C	D	E	F	Solder Tail	Contact	Barbed G/B Leads			Barbless G/B Leads			
									Tube	T&R Vacuum Caps		Tube	T&R Vacuum Caps		
							With			Without			With		Without
38	25.40 1.000	22.81 .898	11.43 .450	0	—	1.52 [.060]	SnPb	Gold	767005-8◆	767149-1◆	767149-8◆	767120-1◆	767121-1◆	767121-8◆	
						2.64 [.104]			PdNi	767057-1◆	—	—	767082-1◆	—	—
						1.52 [.060]		Pb-free	Gold	5767005-8	5767149-1	5767149-8	5767120-1	5767121-1	5767121-8
						2.64 [.104]			PdNi	5767057-1	—	—	5767082-1	—	—
76	38.10 1.500	31.70 1.248	24.13 .950	1	12.70 .500	1.52 [.060]	SnPb	Gold	767005-9◆	767149-2◆	767149-9◆	767120-2◆	767121-2◆	767121-9◆	
						2.64 [.104]			PdNi	767057-2◆	—	—	767082-2◆	—	—
						1.52 [.060]		Pb-free	Gold	5767005-9	5767149-2	5767149-9	5767120-2	5767121-2	5767121-9
						2.64 [.104]			PdNi	5767057-2	—	—	5767082-2	—	—
114	50.80 2.000	48.21 1.898	36.83 1.450	2	25.40 1.000	1.52 [.060]	SnPb	Gold	1-767005-0◆	767149-3◆	1-767149-0◆	767120-3◆	767121-3◆	1-767121-0◆	
						2.64 [.104]			PdNi	767057-3◆	—	—	767082-3◆	—	—
						1.52 [.060]		Pb-free	Gold	1-5767005-0	5767149-3	1-5767149-0	5767120-3	5767121-3	1-5767121-0
						2.64 [.104]			PdNi	5767057-3	—	—	5767082-3	—	—
152	63.50 2.500	60.91 2.398	49.53 1.950	3	38.10 1.500	1.52 [.060]	SnPb	Gold	1-767005-1◆	767149-4◆	1-767149-1◆	767120-4◆	767121-4◆	1-767121-1◆	
						2.64 [.104]			PdNi	767057-4◆	—	—	767082-4◆	767127-4◆	1-767127-1◆
						1.52 [.060]		Pb-free	Gold	1-5767005-1	5767149-4	1-5767149-1	5767120-4	5767121-4	1-5767121-1
						2.64 [.104]			PdNi	5767057-4	—	—	5767082-4	5767127-4	1-5767127-1
190	76.20 3.000	73.61 2.898	62.23 2.450	4	50.80 2.000	1.52 [.060]	SnPb	Gold	1-767005-2◆	767149-5◆	1-767149-2◆	767120-5◆	—	—	
						2.64 [.104]			PdNi	767057-5◆	—	—	767082-5◆	767127-5◆	1-767121-2◆
						1.52 [.060]		Pb-free	Gold	1-5767005-2	5767149-5	1-5767149-2	5767120-5	—	—
						2.64 [.104]			PdNi	5767057-5	—	—	5767082-5	5767127-5	1-5767121-2
228	88.90 3.500	86.31 3.398	74.93 2.950	5	63.50 2.500	1.52 [.060]	SnPb	Gold	1-767005-3◆	—	—	767120-6◆	—	—	
						2.64 [.104]			PdNi	767057-6◆	—	—	767082-6◆	—	—
						1.52 [.060]		Pb-free	Gold	1-5767005-3	—	—	5767120-6	—	—
						2.64 [.104]			PdNi	5767057-6	—	—	5767082-6	—	—
266	101.60 4.000	99.01 3.898	87.63 3.450	6	76.20 3.000	1.52 [.060]	SnPb	Gold	1-767005-4◆	—	—	767120-7◆	—	—	
						2.64 [.104]			PdNi	767057-7◆	—	1-767151-4◆	767082-7◆	—	—
						1.52 [.060]		Pb-free	Gold	1-5767005-4	—	—	5767120-7	—	—
						2.64 [.104]			PdNi	5767057-7	—	1-5767151-4	5767082-7	—	—

Note: Contact Product Engineering regarding options not present in this table.

Note: Part Numbers are RoHS compliant except: ◆ Indicates non-RoHS compliant;
● Indicates "5 of 6 compliant" (lead in solderable interface only).

MICTOR Vertical Plugs (Continued)

**17.96 [.707]
Stacking Height***

Related Product Data

Material and Finish — page 16

Performance Characteristics —
page 16

Mating Receptacles — pages 36-41

Technical Documents — page 81

* 17.96 [.707] stack height when mated to vertical receptacle;
27.00 [1.062] stack height when mated to vertical receptacle (extended height).

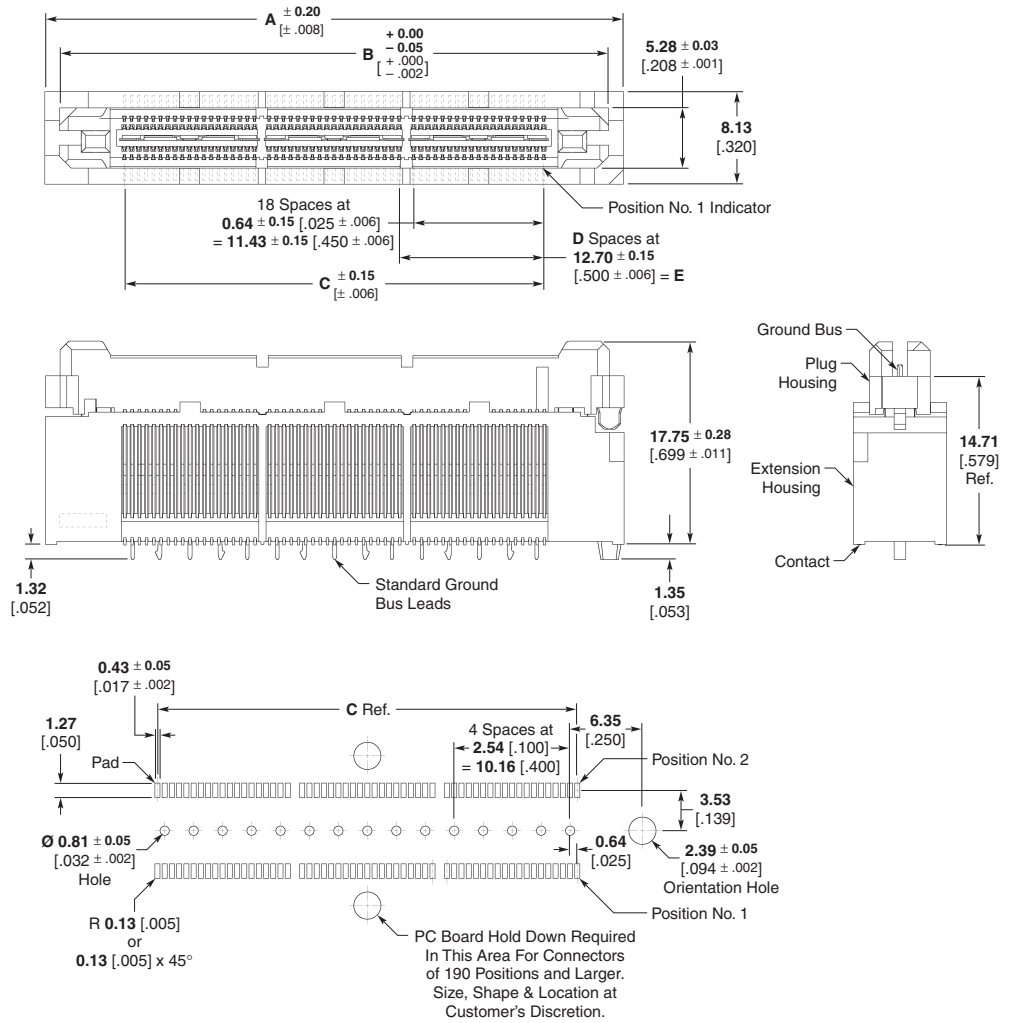

**Recommended PC Board Layout
(Connector Side of Board Shown)**

- Notes:**
1. For dual application, the orientation hole must be 1.98 ± 0.03 [.078 ± .001]. See Application Specification 114-11004 for details.
 2. Connectors with extended ground bus leads can be made available, consult Tyco Electronics.

MICTOR Vertical Plugs (Continued)

17.96 [.707] Stacking Height (Continued)

No. of Pos.	Dimensions					Plating	Part Numbers
	A	B	C	D	E		
38	25.40	22.81	11.43	0	0.00	SnPb	767025-1●
	1.000	.898	.450			Pb-free	5767025-1
76	38.10	35.51	24.13	1	12.70	SnPb	767025-2●
	1.500	1.398	.950			Pb-free	5767025-2
114	50.80	48.21	36.83	2	25.40	SnPb	767025-3●
	2.000	1.898	1.450			Pb-free	5767025-3
152	63.50	60.91	49.53	3	38.10	SnPb	767025-4●
	2.500	2.398	1.950			Pb-free	5767025-4
190	76.20	73.61	62.23	4	50.80	SnPb	767025-5●
	3.000	2.898	2.450			Pb-free	5767025-5
228	88.90	86.31	74.93	5	63.50	SnPb	767025-6●
	3.500	3.398	2.950			Pb-free	5767025-6
266	101.60	99.00	87.63	6	76.20	SnPb	767025-7●
	4.000	3.898	3.450			Pb-free	5767025-7

Note: Part Numbers are RoHS compliant except: ♦ Indicates non-RoHS compliant;
● Indicates "5 of 6 compliant" (lead in solderable interface only).

MICTOR Vertical Plugs (Continued)

**18.75 [.738]
Stacking Height***

Related Product Data

- Material and Finish** — page 16
- Performance Characteristics** — page 16
- Mating Receptacles** — pages 36-41
- Technical Documents** — page 81

* 18.75 [.738] stack height when mated to vertical receptacle;
27.80 [1.093] stack height when mated to vertical receptacle (extended height).

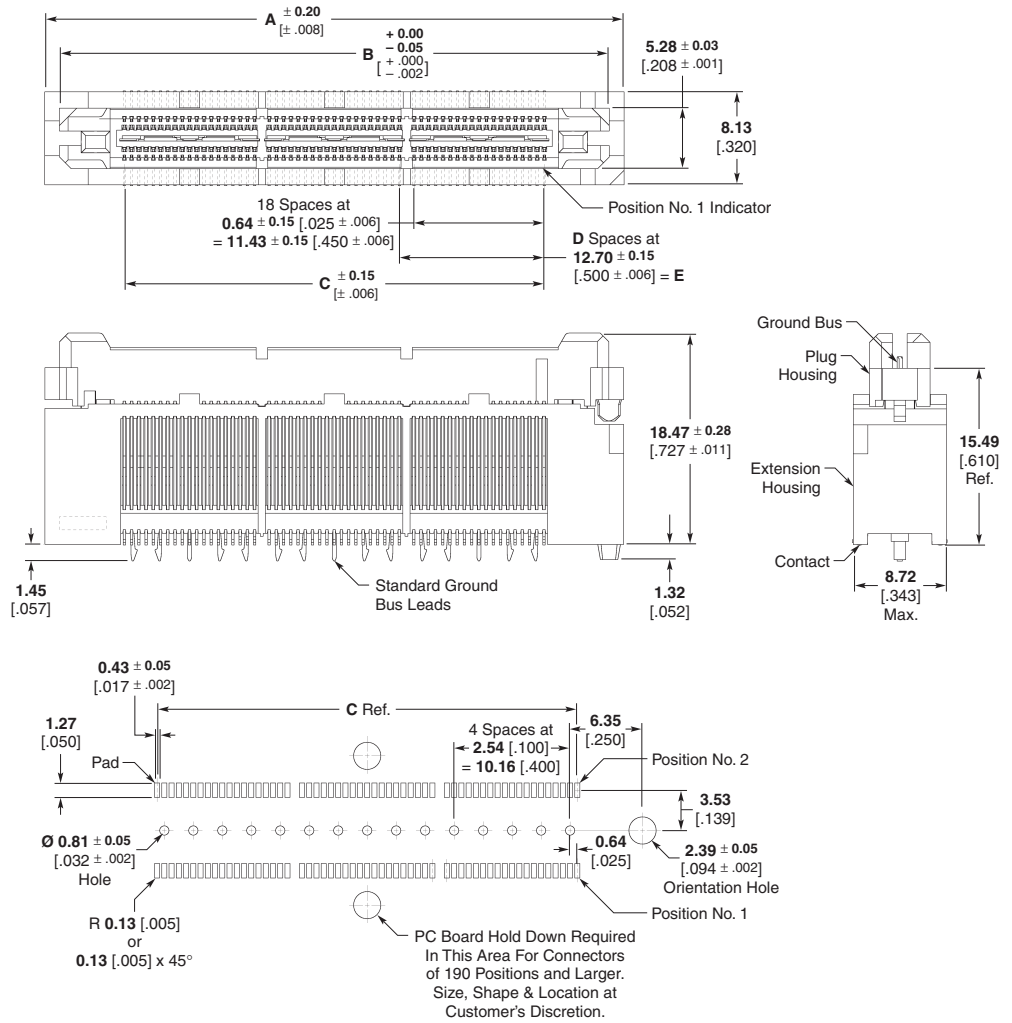

**Recommended PC Board Layout
(Connector Side of Board Shown)**

No. of Pos.	Dimensions					Plating	Part Numbers
	A	B	C	D	E		
38	25.40 1.000	22.81 .898	11.43 .450	0	0.00 .000	SnPb Pb-free	767042-1◆ 5767042-1
76	38.10 1.500	35.51 1.398	24.13 .950	1	12.70 .500	SnPb Pb-free	767042-2◆ 5767042-2
114	50.80 2.000	48.21 1.898	36.83 1.450	2	25.40 1.000	SnPb Pb-free	767042-3◆ 5767042-3
152	63.50 2.500	60.91 2.398	49.53 1.950	3	38.10 1.500	SnPb Pb-free	767042-4◆ 5767042-4
190	76.20 3.000	73.61 2.898	62.23 2.450	4	50.80 2.000	SnPb Pb-free	767042-5◆ 5767042-5
228	88.90 3.500	86.31 3.398	74.93 2.950	5	63.50 2.500	SnPb Pb-free	767042-6◆ 5767042-6
266	101.60 4.000	99.00 3.898	87.63 3.450	6	76.20 3.000	SnPb Pb-free	767042-7◆ 5767042-7

Note: Part Numbers are RoHS compliant except: ◆ Indicates non-RoHS compliant;
● Indicates "5 of 6 compliant" (lead in solderable interface only).

MICTOR Vertical Plugs (Continued)

**20.00 [.785]
Stacking Height***

Related Product Data

- Material and Finish** — page 16
- Performance Characteristics** — page 16
- Mating Receptacles** — pages 36-41
- Technical Documents** — page 81

* 20.02 [.788] stack height when mated to vertical receptacle;
29.00 [1.143] stack height when mated to vertical receptacle (extended height).

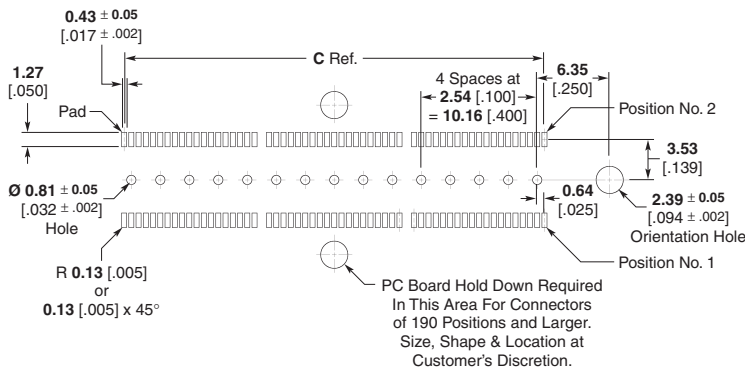
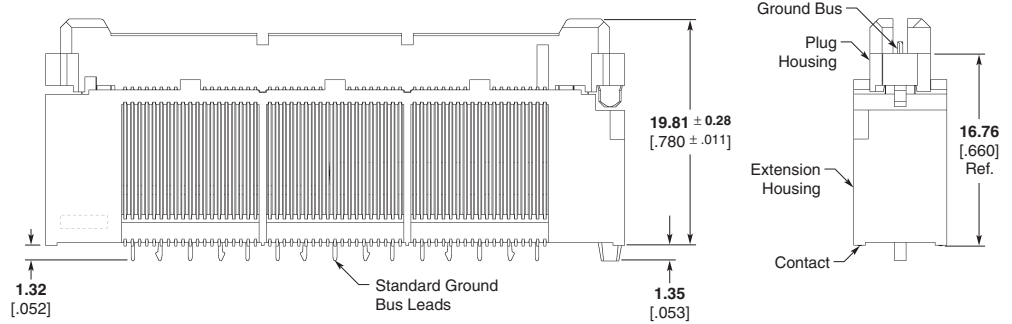
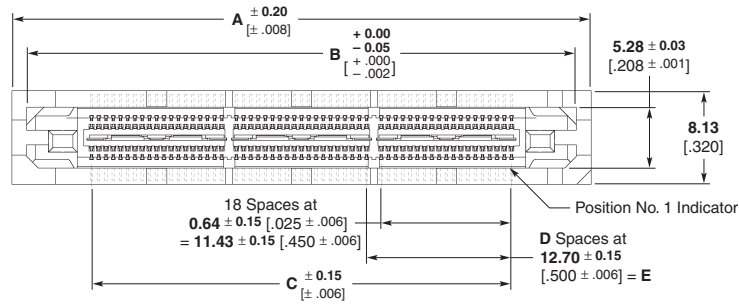

**Recommended PC Board Layout
(Connector Side of Board Shown)**

- Notes:**
1. For dual application, the orientation hole must be 1.98 ± 0.03 [$.078 \pm .001$]. See Application Specification 114-11004 for details.
 2. Connectors with extended ground bus leads can be made available, consult Tyco Electronics.

MICTOR Vertical Plugs (Continued)

20.00 [.785] Stacking Height (Continued)

No. of Pos.	Dimensions					Plating	Part Numbers
	A	B	C	D	E		
38	25.40	22.81	11.43	0	0.00	SnPb	767032-1●
	1.000	.898	.450		.000	Pb-free	5767032-1
76	38.10	35.51	24.13	1	12.70	SnPb	767032-2●
	1.500	1.398	.950		.500	Pb-free	5767032-2
114	50.80	48.21	36.83	2	25.40	SnPb	767032-3●
	2.000	1.898	1.450		1.000	Pb-free	5767032-3
152	63.50	60.91	49.53	3	38.10	SnPb	767032-4●
	2.500	2.398	1.950		1.500	Pb-free	5767032-4
190	76.20	73.61	62.23	4	50.80	SnPb	767032-5●
	3.000	2.898	2.450		2.000	Pb-free	5767032-5
228	88.90	86.31	74.93	5	63.50	SnPb	767032-6●
	3.500	3.398	2.950		2.500	Pb-free	5767032-6
266	101.60	99.00	87.63	6	76.20	SnPb	767032-7●
	4.000	3.898	3.450		3.000	Pb-free	5767032-7

Note: Part Numbers are RoHS compliant except: ♦ Indicates non-RoHS compliant;
● Indicates "5 of 6 compliant" (lead in solderable interface only).

MICTOR Vertical Plugs (Continued)

**22.86 [.900]
Stacking Height***

Related Product Data

- Material and Finish** — page 16
- Performance Characteristics** — page 16
- Mating Receptacles** — pages 36-41
- Technical Documents** — page 81

* 22.86 [.900] stack height when mated to vertical receptacle;
31.90 [1.255] stack height when mated to vertical receptacle (extended height).

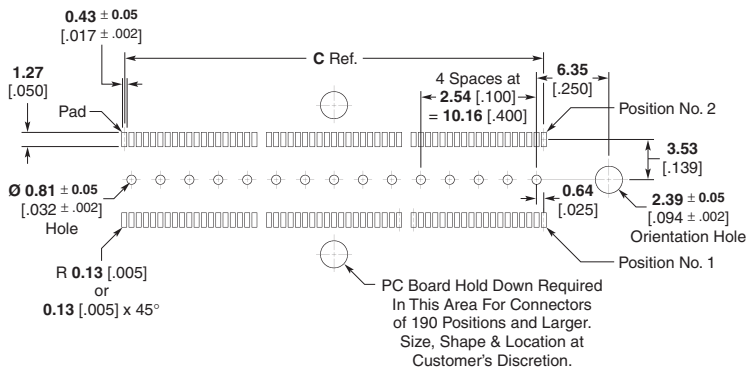
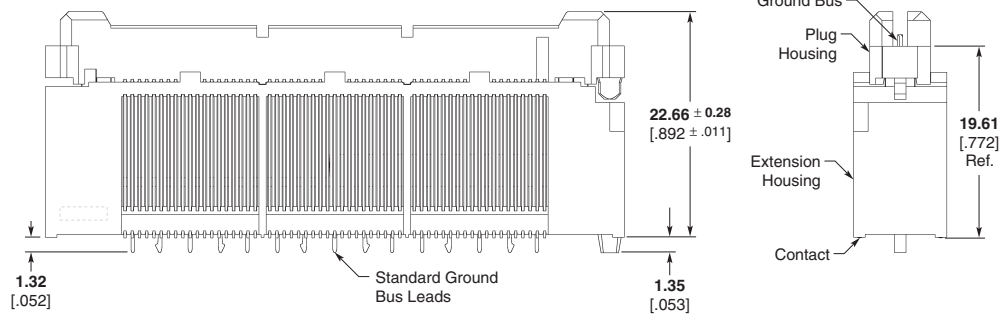
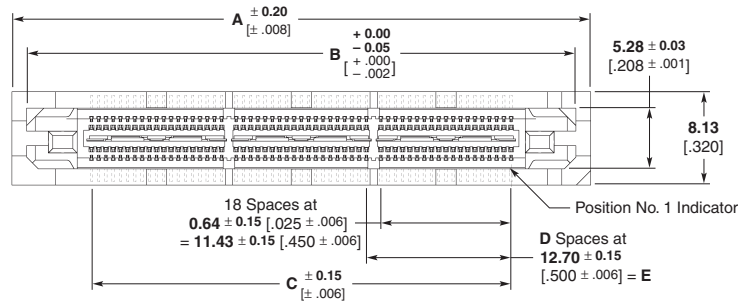

**Recommended PC Board Layout
(Connector Side of Board Shown)**

- Notes:** 1. For dual application, the orientation hole must be 1.98±0.03 [.078±.001]. See Application Specification 114-11004 for details.
2. Connectors with extended ground bus leads can be made available, consult Tyco Electronics.

**MICTOR
Interconnection System**

MICTOR Vertical Plugs (Continued)

22.86 [.900] Stacking Height (Continued)

No. of Pos.	Dimensions					Plating	Part Numbers
	A	B	C	D	E		
38	25.40	22.81	11.43	0	0.00	SnPb	767017-1●
	1.000	.898	.450		.000	Pb-free	5767017-1
76	38.10	35.51	24.13	1	12.70	SnPb	767017-2●
	1.500	1.398	.950		.500	Pb-free	5767017-2
114	50.80	48.21	36.83	2	25.40	SnPb	767017-3●
	2.000	1.898	1.450		1.000	Pb-free	5767017-3
152	63.50	60.91	49.53	3	38.10	SnPb	767017-4●
	2.500	2.398	1.950		1.500	Pb-free	5767017-4
190	76.20	73.61	62.23	4	50.80	SnPb	767017-5●
	3.000	2.898	2.450		2.000	Pb-free	5767017-5
228	88.90	86.31	74.93	5	63.50	SnPb	767017-6●
	3.500	3.398	2.950		2.500	Pb-free	5767017-6
266	101.60	99.00	87.63	6	76.20	SnPb	767017-7●
	4.000	3.898	3.450		3.000	Pb-free	5767017-7

Note: Part Numbers are RoHS compliant except: ◆ Indicates non-RoHS compliant;
● Indicates "5 of 6 compliant" (lead in solderable interface only).

MICTOR Right-Angle Plugs (Continued)

No. of Pos.	Dimensions						Platings		Part Numbers Tube
	A	B	C	D	E	F	Solder Tail	Contact	
38	25.40 1.000	22.81 .898	11.43 .450	0	0.00 .000	1.52 .060	SnPb	Gold	767006-1●
							Pb-free		5767006-1
							SnPb	PdNi	767055-1●
							Pb-free		5767055-1
76	38.10 1.500	35.51 1.398	24.13 .950	1	12.70 .500	2.31 .091	SnPb	PdNi	767039-1●
							Pb-free		5767039-1
							SnPb	Gold	767006-2●
							Pb-free		5767006-2
114	50.80 2.000	48.21 1.898	36.83 1.450	2	25.40 1.000	1.52 .060	SnPb	PdNi	767055-3●
							Pb-free		5767055-3
							SnPb	PdNi	767039-3●
							Pb-free		5767039-3
152	63.50 2.500	60.91 2.398	49.53 1.950	3	38.10 1.500	2.31 .091	SnPb	PdNi	767055-4●
							Pb-free		5767055-4
							SnPb	Gold	767006-4●
							Pb-free		5767006-4
190	76.20 3.000	73.61 2.898	62.23 2.450	4	50.80 2.000	1.52 .060	SnPb	PdNi	767055-5●
							Pb-free		5767055-5
							SnPb	PdNi	767039-5●
							Pb-free		5767039-5
228	88.90 3.500	86.31 3.398	74.93 2.950	5	63.50 2.500	2.31 .091	SnPb	PdNi	767055-6●
							Pb-free		5767055-6
							SnPb	Gold	767006-6●
							Pb-free		5767006-6
266	101.60 4.000	99.00 3.898	87.63 3.450	6	76.20 3.000	1.52 .060	SnPb	PdNi	767055-7●
							Pb-free		5767055-7
							SnPb	Gold	767006-7●
							Pb-free		5767006-7
						2.31 .091	SnPb	PdNi	767039-7●
							Pb-free		5767039-7

S = Printed circuit board thickness connector is intended to be used on.

Note: Part Numbers are RoHS compliant except: ♦ Indicates non-RoHS compliant;
● Indicates "5 of 6 compliant" (lead in solderable interface only).

MICTOR Vertical Receptacles

Related Product Data

Material and Finish — page 16

Performance Characteristics — page 16

Mating Plugs — pages 19-35

Technical Documents — page 81

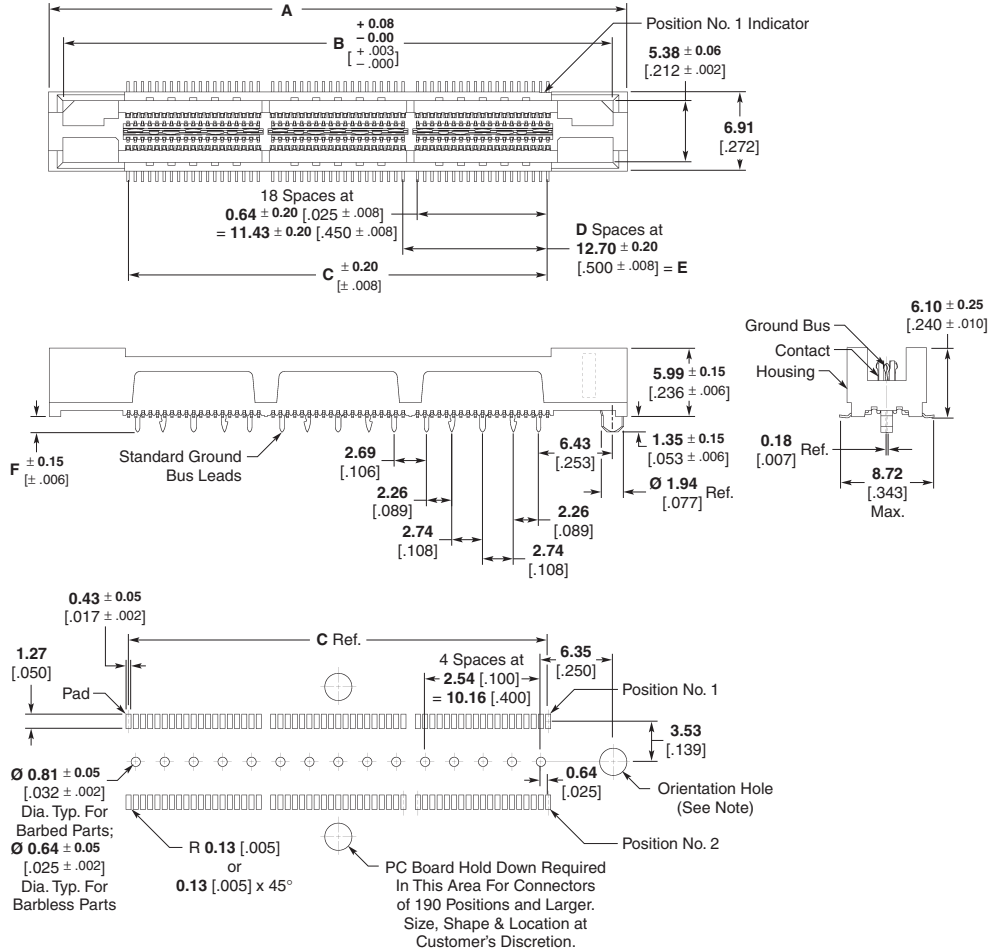

**Recommended PC Board Layout
(Connector Side of Board Shown)**

Note: For standard applications, orientation hole to be $\phi 2.39 \pm 0.05$ [$.094 \pm .002$]; For slip-fit applications, orientation hole to be $\phi 2.00 \pm 0.03$ [$.079 \pm .001$].

MICTOR Vertical Receptacles (Continued)

No. of Pos.	Dimensions						Platings		Part Numbers							
	A	B	C	D	E	F	Solder Tail	Contact	Barbed G/B Leads			Barbless G/B Leads				
									Tube	T&R Vacuum Caps		Tube	T&R Vacuum Caps			
										With	Without		With	Without		
38	25.40 1.000	22.86 .900	11.43 .450	0	—	—	SnPb	Gold	2-767004-2◆	767096-8◆	767096-1◆	767110-1◆	767114-1◆	767114-8◆		
									PdNi	767181-1◆	—	—	—	—		
								2.74 .108	SnPb	PdNi	767054-1◆	767171-1◆	—	767081-1◆	767115-1◆	—
											Pb-free	Gold	2-5767004-2	5767096-8	5767096-1	5767110-1
								2.74 .108	Pb-free	PdNi	5767181-1	—	—	—	—	—
											Gold	5767054-1	5767171-1	—	5767081-1	5767115-1
76	38.10 1.500	35.56 1.400	24.13 .950	1	12.70 .500	—	SnPb	Gold	2-767004-3◆	767096-9◆	767096-2◆	767110-2◆	767114-2◆	767114-9◆		
									PdNi	767181-2◆	—	—	—	—		
								2.74 .108	SnPb	PdNi	767054-2◆	—	—	767081-2◆	767115-2◆	—
											Pb-free	Gold	2-5767004-3	5767096-9	5767096-2	5767110-2
								2.74 .108	Pb-free	PdNi	5767181-2	—	—	—	—	—
											Gold	5767054-2	—	—	5767081-2	5767115-2
114	50.80 2.000	48.26 1.900	36.83 1.450	2	25.40 1.000	—	SnPb	Gold	2-767004-4◆	1-767096-0◆	767096-3◆	767110-3◆	767114-3◆	1-767114-0◆		
									PdNi	767181-3◆	—	—	—	—		
								2.74 .108	SnPb	PdNi	767054-3◆	—	—	767081-3◆	767115-3◆	—
											Pb-free	Gold	2-5767004-4	1-5767096-0	5767096-3	5767110-3
								2.74 .108	Pb-free	PdNi	5767181-3	—	—	—	—	—
											Gold	5767054-3	—	—	5767081-3	5767115-3
152	63.50 2.500	60.96 2.400	49.53 1.950	3	38.10 1.500	—	SnPb	Gold	2-767004-5◆	1-767096-1◆	767096-4◆	767110-4◆	767114-4◆	1-767114-1◆		
									PdNi	767181-4◆	—	—	—	—		
								2.74 .108	SnPb	PdNi	767054-4◆	—	—	767081-4◆	767115-4◆	—
											Pb-free	Gold	2-5767004-5	1-5767096-1	5767096-4	5767110-4
								2.74 .108	Pb-free	PdNi	5767181-4	—	—	—	—	—
											Gold	5767054-4	—	—	5767081-4	5767115-4
190	76.20 3.000	73.66 2.900	62.23 2.450	4	50.80 2.000	—	SnPb	Gold	2-767004-6◆	1-767096-2◆	767096-5◆	767110-5◆	767114-5◆	1-767114-2◆		
									PdNi	767181-5◆	—	—	—	—		
								2.74 .108	SnPb	PdNi	767054-5◆	—	—	767081-5◆	767115-5◆	—
											Pb-free	Gold	2-5767004-6	1-5767096-2	5767096-5	5767110-5
								2.74 .108	Pb-free	PdNi	5767181-5	—	—	—	—	—
											Gold	5767054-5	—	—	5767081-5	5767115-5
228	88.90 3.500	86.36 3.400	74.93 2.950	5	63.50 2.500	—	SnPb	Gold	2-767004-7◆	1-767096-3◆	—	767110-6◆	—	—		
									PdNi	767181-6◆	—	—	—	—		
								2.74 .108	SnPb	PdNi	767054-6◆	—	—	767081-6◆	—	—
											Pb-free	Gold	2-5767004-7	—	—	5767110-6
								2.74 .108	Pb-free	PdNi	5767181-6	—	—	—	—	—
											Gold	5767054-6	—	—	5767081-6	—
266	101.60 4.000	99.06 3.900	87.63 3.450	6	76.20 3.000	—	SnPb	Gold	2-767004-8◆	—	—	767110-7◆	—	—		
									PdNi	767181-7◆	—	—	—	—		
								2.74 .108	SnPb	PdNi	767054-7◆	—	—	767081-7◆	—	—
											Pb-free	Gold	2-5767004-8	—	—	5767110-7
								2.74 .108	Pb-free	PdNi	5767181-7	—	—	—	—	—
											Gold	5767054-7	—	—	5767081-7	—

Note: Contact Product Engineering regarding options not present in this table.

Note: Part Numbers are RoHS compliant except: ◆ Indicates non-RoHS compliant;
● Indicates "5 of 6 compliant" (lead in solderable interface only).

MICTOR Vertical Receptacles (Extended Height)

Related Product Data

Material and Finish — page 16

Performance Characteristics — page 16

Mating Plugs — pages 19-35

Technical Documents — page 81

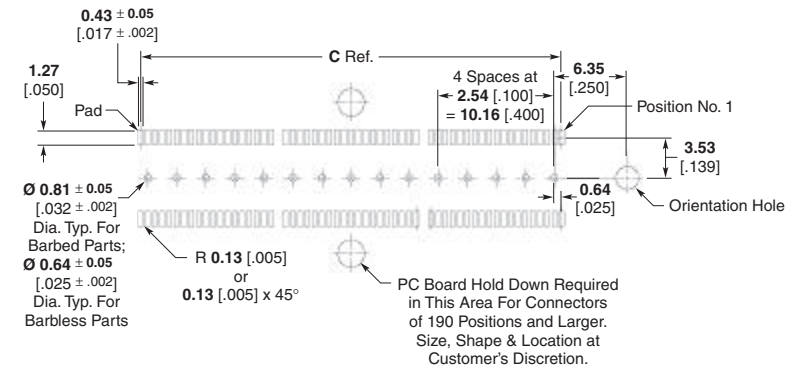
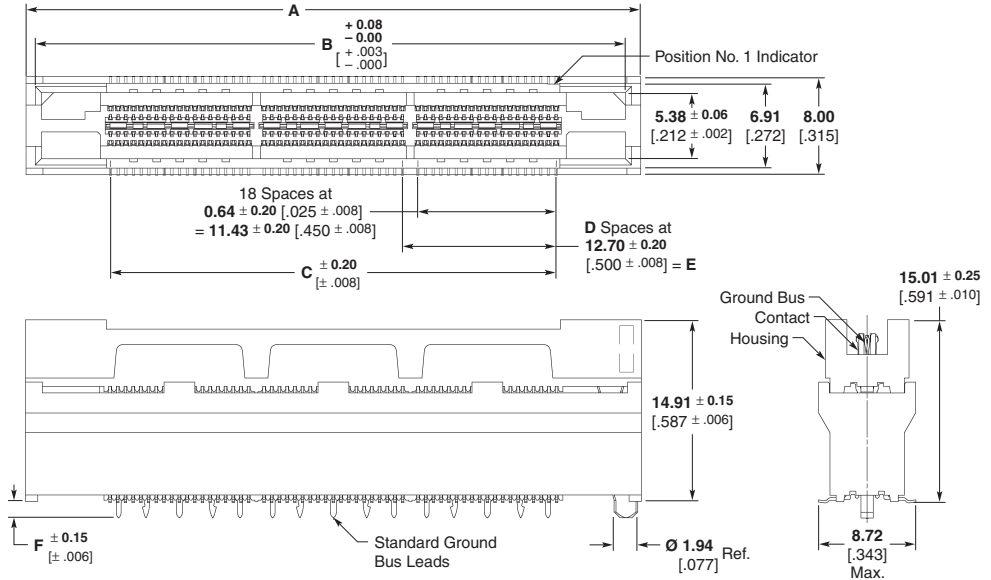

**Recommended PC Board Layout
(Connector Side of Board Shown)**

**MICTOR
Interconnection System**

MICTOR Vertical Receptacles (Extended Height) (Continued)

No. of Pos.	Dimensions						Platings		Part Numbers					
	A	B	C	D	E	F	Solder Tail	Contact	Barbed G/B Leads			Barbless G/B Leads		
									Tube	T&R Vacuum Caps		Tube	T&R Vacuum Caps	
										With	Without		With	Without
38	25.40 1.000	22.86 .900	11.43 .450	0	—	1.37 [.054]	SnPb	Gold	767130-1◆	767146-1◆	767146-8◆	—	—	—
						1.37 [.054]		PdNi	767094-1◆	767178-1◆	767178-8◆	—	—	—
						2.72 [.107]			767154-1◆	—	767153-8◆	767095-1◆	—	—
						1.37 [.054]	Pb-free	Gold	5767130-1	5767146-1	5767146-8	—	—	—
						1.37 [.054]		PdNi	5767094-1	5767178-1	1761316-8	—	—	—
						2.72 [.107]			5767154-1	—	5767153-8	5767095-1	—	—
76	38.10 1.500	35.56 1.400	24.13 .950	1	12.70 .500	1.37 [.054]	SnPb	Gold	767130-2◆	767146-2◆	767146-9◆	—	—	—
						1.37 [.054]		PdNi	767094-2◆	767178-2◆	—	—	—	—
						2.72 [.107]			767154-2◆	—	767153-9◆	767095-2◆	—	—
						1.37 [.054]	Pb-free	Gold	5767130-2	5767146-2	5767146-9	—	—	—
						1.37 [.054]		PdNi	5767094-2	5767178-2	—	—	—	—
						2.72 [.107]			5767154-2	—	5767153-9	5767095-2	—	—
114	50.80 2.000	48.26 1.900	36.83 1.450	2	25.40 1.000	1.37 [.054]	SnPb	Gold	767130-3◆	767146-3◆	1-767146-0◆	—	—	—
						1.37 [.054]		PdNi	767094-3◆	—	—	—	—	—
						2.72 [.107]			767154-3◆	—	1-767153-0◆	767095-3◆	767145-3◆	1-767145-0◆
						1.37 [.054]	Pb-free	Gold	5767130-3	5767146-3	1-5767146-0	—	—	—
						1.37 [.054]		PdNi	5767094-3	—	—	—	—	—
						2.72 [.107]			5767154-3	—	1-5767153-0	5767095-3	5767145-3	1-5767145-0
152	63.50 2.500	60.96 2.400	49.53 1.950	3	38.10 1.500	1.37 [.054]	SnPb	Gold	767130-4◆	767146-4◆	1-767146-1◆	—	—	—
						1.37 [.054]		PdNi	767094-4◆	—	—	—	—	—
						2.72 [.107]			767154-4◆	—	1-767153-1◆	767095-4◆	—	1-767145-1◆
						1.37 [.054]	Pb-free	Gold	5767130-4	5767146-4	1-5767146-1	—	—	—
						1.37 [.054]		PdNi	5767094-4	—	—	—	—	—
						2.72 [.107]			5767154-4	—	1-5767153-1	5767095-4	—	1-5767145-1
190	76.20 3.000	73.66 2.900	62.23 2.450	4	50.80 2.000	1.37 [.054]	SnPb	Gold	767130-5◆	—	—	—	—	—
						1.37 [.054]		PdNi	767094-5◆	767178-5◆	1-767178-2◆	—	—	—
						2.72 [.107]			767154-5◆	—	1-767153-2◆	767095-5◆	—	—
						1.37 [.054]	Pb-free	Gold	5767130-5	—	—	—	—	—
						1.37 [.054]		PdNi	5767094-5	5767178-5	1-1761316-2	—	—	—
						2.72 [.107]			5767154-5	—	1-5767153-2	5767095-5	—	—
228	88.90 3.500	86.36 3.400	74.93 2.950	5	63.50 2.500	1.37 [.054]	SnPb	Gold	767130-6◆	—	—	—	—	—
						1.37 [.054]		PdNi	767094-6◆	—	—	—	—	—
						2.72 [.107]			767154-6◆	—	1-767153-3◆	767095-6◆	—	—
						1.37 [.054]	Pb-free	Gold	5767130-6	—	—	—	—	—
						1.37 [.054]		PdNi	5767094-6	—	—	—	—	—
						2.72 [.107]			5767154-6	—	1-5767153-3	5767095-6	—	—
266	101.60 4.000	99.06 3.900	87.63 3.450	6	76.20 3.000	1.37 [.054]	SnPb	Gold	767130-7◆	—	—	—	—	—
						1.37 [.054]		PdNi	767094-7◆	—	—	—	—	—
						2.72 [.107]			767154-7◆	—	1-767153-4◆	767095-7◆	—	—
						1.37 [.054]	Pb-free	Gold	5767130-7	—	—	—	—	—
						1.37 [.054]		PdNi	5767094-7	—	—	—	—	—
						2.72 [.107]			5767154-7	—	1-5767153-4	5767095-7	—	—

Note: Contact Product Engineering regarding options not present in this table.

Note: Part Numbers are RoHS compliant except: ◆ Indicates non-RoHS compliant;
● Indicates "5 of 6 compliant" (lead in solderable interface only).

MICTOR Right-Angle Receptacles

Related Product Data

Material and Finish — page 16

Performance Characteristics —
page 16

Mating Plugs — pages 19-35

Application Tooling — page 77

Technical Documents — page 81

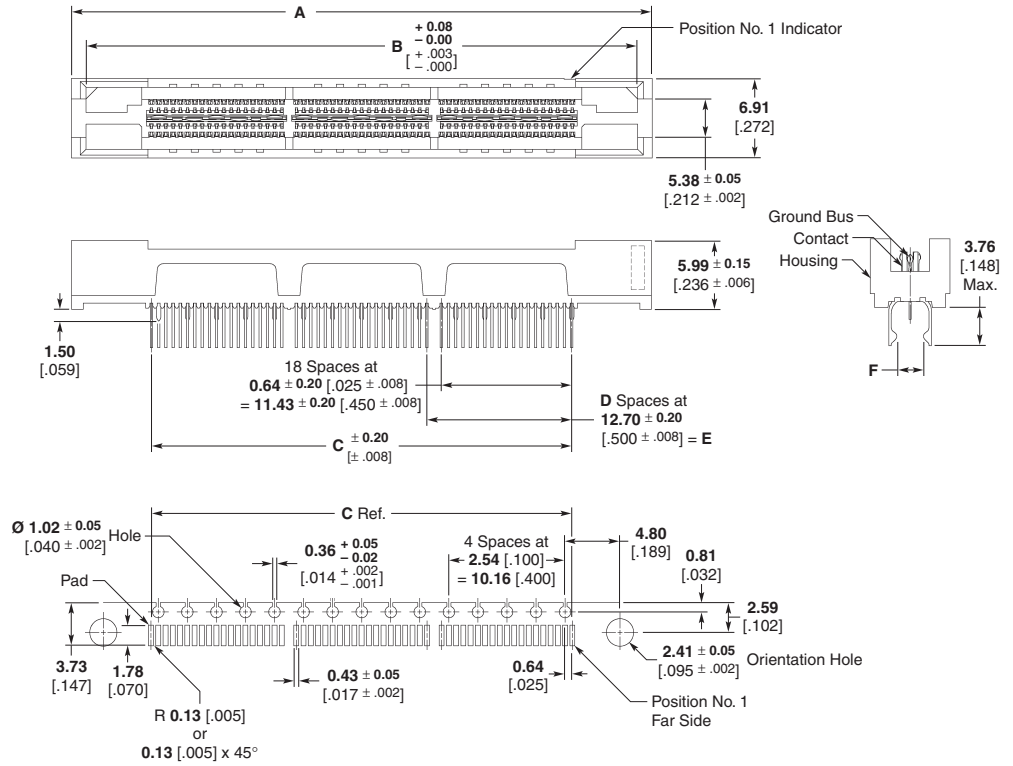

Recommended PC Board Layout
(Mirror image on opposite side)
PC Board Thickness: 1.57 [0.062]

MICTOR
Interconnection System