

## 2.5V or 3.3V 200 MHz 1:15 Clock Distribution Buffer

### Features

- 2.5V or 3.3V operation
- 200-MHz clock support
- LVPECL or LVCMOS/LVTTL clock input
- LVCMOS/LVTTL compatible outputs
- 15 clock outputs: drive up to 30 clock lines
- 1X and 1/2X configurable outputs
- Output three-state control
- 350 ps maximum output-to-output skew
- Pin compatible with MPC949, MPC9449
- Available in Commercial and Industrial temperature range
- 52-pin TQFP package

### Description

The CY29949 is a low voltage 200 MHz clock distribution buffer with the capability to select either a differential LVPECL or LVCMOS/LVTTL compatible input clocks. These clock sources are used to provide for test clocks and primary system clocks. All other control inputs are LVCMOS/LVTTL compatible. The 15 outputs are LVCMOS or LVTTL compatible and can drive 50Ω series or parallel terminated transmission lines. For series terminated transmission lines, each output can drive one or two traces giving the device an effective fanout of 1:30.

The CY29949 is capable of generating 1X and 1/2X signals from a 1X source. These signals are generated and retimed internally to ensure minimal skew between the 1X and 1/2X signals. SEL(A:D) inputs allow flexibility in selecting the ratio of 1X to 1/2X outputs.

The CY29949 outputs can also be three-stated via the MR/OE# input. When MR/OE# is set HIGH, it resets the internal flip-flops and three-states the outputs.

### Logic Block Diagram

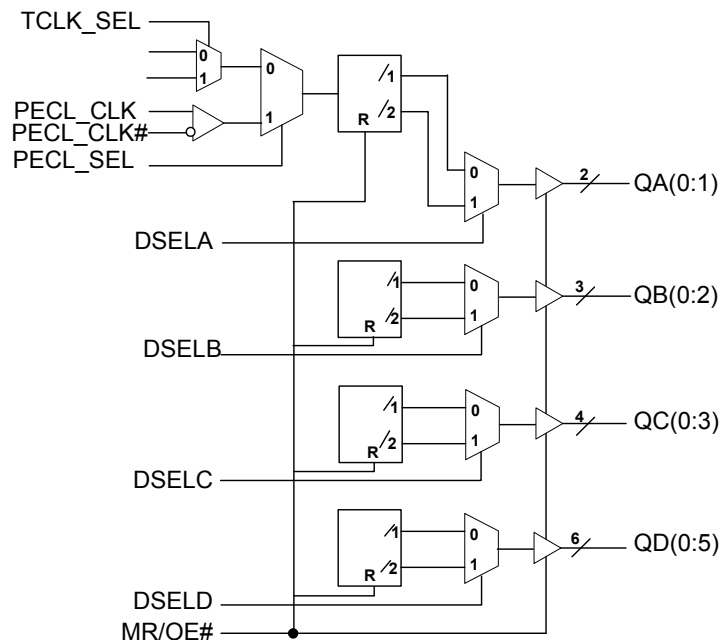

## Pin Configuration

Figure 1. Pin Diagram - CY29949

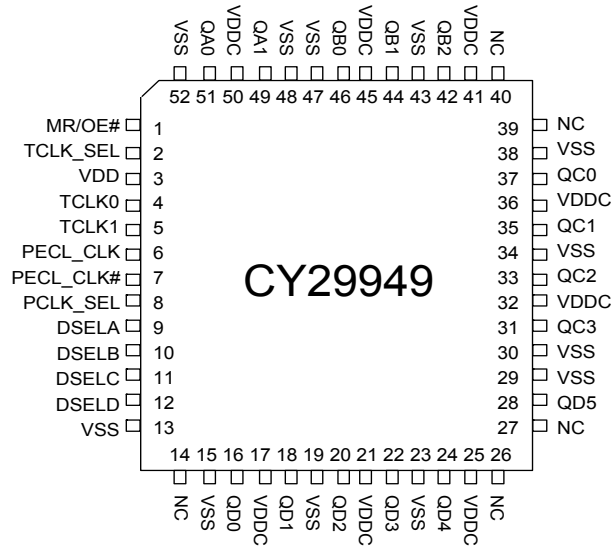

## Pin Description

Pin	Name	PWR	I/O <sup>[1]</sup>	Description
6	PECL_CLK		I, PD	<b>PECL Input Clock</b>
7	PECL_CLK#		I, PU	<b>PECL Input Clock</b>
4, 5	TCLK(0,1)		I, PU	<b>External Reference/Test Clock Input</b>
49, 51	QA(1,0)	VDDC	O	<b>Clock Outputs</b>
42, 44, 46	QB(2:0)	VDDC	O	<b>Clock Outputs</b>
31, 33, 35, 37	QC(3:0)	VDDC	O	<b>Clock Outputs</b>
16, 18, 20, 22, 24, 28	QD(5:0)	VDDC	O	<b>Clock Outputs</b>
9, 10, 11, 12	DSEL(A:D)		I, PD	<b>Divider Select Inputs.</b> When HIGH, selects ÷2 input divider. When LOW, selects ÷1 input divider.
2	TCLK_SEL		I, PD	<b>TCLK Select Input.</b> When LOW, TCLK0 clock is selected and when HIGH TCLK1 is selected.
8	PCLK_SEL		I, PD	<b>PECL Select Input.</b> When HIGH, PECL clock is selected and when LOW TCLK(0,1) is selected
1	MR/OE#		I, PD	<b>Output Enable Input.</b> When asserted LOW, the outputs are enabled and when asserted HIGH, internal flip-flops are reset and the outputs are three-stated. If more than one bank is used in /2 mode, a reset must be performed (MR/OE# asserted high) after power up to ensure that all internal flip-flops are set to the same state.
17, 21, 25, 32, 36, 41, 45, 50	VDDC			<b>2.5V or 3.3V Power Supply for Output Clock Buffers</b>
3	VDD			<b>2.5V or 3.3V Power Supply</b>
13, 15, 19, 23, 29, 30, 34, 38, 43, 47, 48, 52	VSS			<b>Common Ground</b>
14, 26, 27, 39, 40,	NC			<b>Not Connected</b>

**Note**

1. PD = internal pull-down, PU = internal pull-up.

**Maximum Ratings<sup>[2]</sup>**

Maximum Input Voltage Relative to  $V_{SS}$ :.....  $V_{SS} - 0.3V$   
 Maximum Input Voltage Relative to  $V_{DD}$ :.....  $V_{DD} + 0.3V$   
 Storage Temperature:.....  $-65^{\circ}C$  to  $+150^{\circ}C$   
 Operating Temperature:.....  $-40^{\circ}C$  to  $+85^{\circ}C$   
 Maximum ESD Protection ..... 2 kV  
 Maximum Power Supply:..... 5.5V  
 Maximum Input Current: .....  $\pm 20$  mA

This device contains circuitry to protect the inputs against damage due to high static voltages or electric field; however, precautions must be taken to avoid application of any voltage higher than the maximum rated voltages to this circuit. For proper operation,  $V_{in}$  and  $V_{out}$  should be constrained to the range:

$$V_{SS} < (V_{in} \text{ or } V_{out}) < V_{DD}$$

Unused inputs must always be tied to an appropriate logic voltage level (either  $V_{SS}$  or  $V_{DD}$ ).

**DC Parameters** ( $V_{DD} = V_{DDC} = 3.3V \pm 10\%$  or  $2.5V \pm 5\%$ , over the specified temperature range)

Parameter	Description	Conditions	Min	Typ	Max	Unit
$V_{IL}$	Input Low Voltage	$V_{DD} = 3.3V$ , PECL_CLK single ended	1.49	–	1.825	V
		$V_{DD} = 2.5V$ , PECL_CLK single ended	1.10	–	1.45	
		All other inputs	$V_{SS}$	–	0.8	
$V_{IH}$	Input High Voltage	$V_{DD} = 3.3V$ , PECL_CLK single ended	2.135	–	2.42	V
		$V_{DD} = 2.5V$ , PECL_CLK single ended	1.75	–	2.0	
		All other inputs	2.0	–	$V_{DD}$	
$I_{IL}$	Input Low Current <sup>[3]</sup>		–	–	–100	$\mu A$
$I_{IH}$	Input High Current <sup>[3]</sup>		–	–	100	
$V_{PP}$	Peak-to-Peak Input Voltage PECL_CLK		300	–	1000	mV
$V_{CMR}$	Common Mode Range <sup>[4]</sup> PECL_CLK	$V_{DD} = 3.3V$	$V_{DD} - 2.0$	–	$V_{DD} - 0.6$	V
		$V_{DD} = 2.5V$	$V_{DD} - 1.2$	–	$V_{DD} - 0.6$	
$V_{OL}$	Output Low Voltage <sup>[5]</sup>	$I_{OL} = 20$ mA	–	–	0.4	V
$V_{OH}$	Output High Voltage <sup>[5]</sup>	$I_{OH} = -20$ mA, $V_{DD} = 3.3V$	2.5	–	–	V
		$I_{OH} = -20$ mA, $V_{DD} = 2.5V$	1.8	–	–	
$I_{DDQ}$	Quiescent Supply Current		–	5	7	mA
$I_{DD}$	Dynamic Supply Current	$V_{DD} = 3.3V$ , Outputs at 100 MHz, CL = 30 pF	–	200	–	mA
		$V_{DD} = 3.3V$ , Outputs at 160 MHz, CL = 30 pF	–	330	–	
		$V_{DD} = 2.5V$ , Outputs at 100 MHz, CL = 30 pF	–	140	–	
		$V_{DD} = 2.5V$ , Outputs at 160 MHz, CL = 30 pF	–	235	–	
$Z_{out}$	Output Impedance	$V_{DD} = 3.3V$	12	15	18	$\Omega$
		$V_{DD} = 2.5V$	14	18	22	
$C_{in}$	Input Capacitance		–	4	–	pF

**Notes**

- Multiple Supplies: The voltage on any input or I/O pin cannot exceed the power pin during power up. Power supply sequencing is NOT required.
- Inputs have pull-up/pull-down resistors that effect input current.
- The  $V_{CMR}$  is the difference from the most positive side of the differential input signal. Normal operation is obtained when the “High” input is within the  $V_{CMR}$  range and the input lies within the  $V_{PP}$  specification.
- Driving series or parallel terminated  $50\Omega$  (or  $50\Omega$  to  $V_{DD}/2$ ) transmission lines.

**AC Parameters** ( $V_{DD} = V_{DCC} = 3.3V \pm 10\%$  or  $2.5V \pm 5\%$ , over the specified temperature range)<sup>[6]</sup>

Parameter	Description	Conditions	Min	Typ	Max	Unit
Fmax	Input Frequency <sup>[7]</sup>	$V_{DD} = 3.3V$	–	–	200	MHz
		$V_{DD} = 2.5V$	–	–	170	
Tpd	PECL_CLK to Q Delay <sup>[7]</sup>	$V_{DD} = 3.3V$	4.0	–	8.6	ns
	TCLK to Q Delay <sup>[7]</sup>		4.2	–	10.5	
	PECL_CLK to Q Delay <sup>[7]</sup>	$V_{DD} = 2.5V$	6.0	–	10.6	
	TCLK to Q Delay <sup>[7]</sup>		6.2	–	10.5	
FoutDC	Output Duty Cycle <sup>[7, 8]</sup>	Measured at $V_{DD}/2$	45	–	55	%
tpZL, tpZH	Output Enable Time (all outputs)		2	–	10	ns
tpLZ, tpHZ	Output Disable Time (all outputs)		2	–	10	ns
Tskew	Output-to-Output Skew <sup>[7, 9]</sup>		–	250	350	ps
Tskew(pp)	Part-to-Part Skew <sup>[10]</sup>	PECL_CLK to Q	–	1.5	2.75	ns
		TCLK to Q	–	2.0	4.0	
Tr/Tf	Output Clocks Rise/Fall Time <sup>[9]</sup>	0.8V to 2.0V, $V_{DD} = 3.3V$	0.10	–	1.0	ns
		0.6V to 1.8V, $V_{DD} = 2.5V$	0.10	–	1.3	

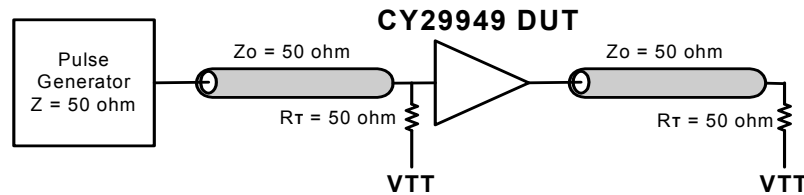
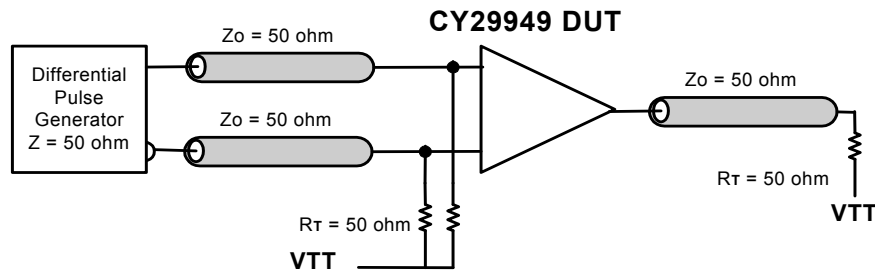
**Figure 2. LVCMOS\_CLK CY29949 Test Reference for  $V_{CC} = 3.3V$  and  $V_{CC} = 2.5V$** 

**Figure 3. PECL\_CLK CY29949 Test Reference for  $V_{CC} = 3.3V$  and  $V_{CC} = 2.5V$** 

**Notes**

6. Parameters are guaranteed by design and characterization. Not 100% tested in production. All parameters specified with loaded outputs.
7. Outputs driving 50Ω transmission lines.
8. 50% input duty cycle.
9. See [Figure 2](#) and [Figure 3](#).
10. Part-to-part skew at a given temperature and voltage.

Figure 4. Propagation Delay (TPD) Test Reference

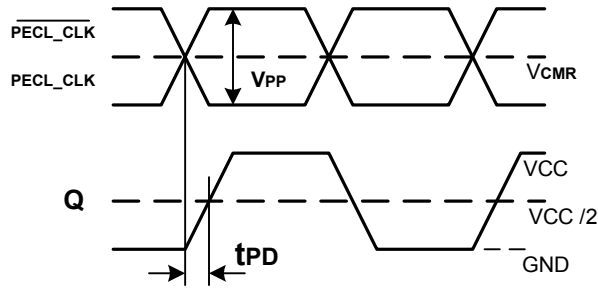

Figure 5. LVCMOS Propagation Delay (TPD) Test Reference

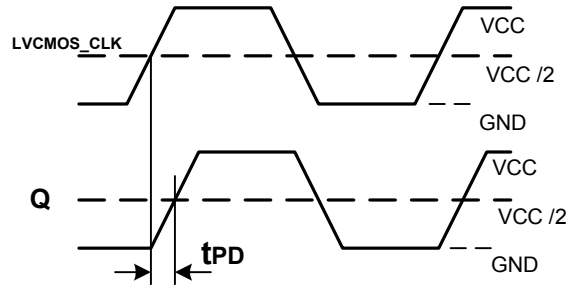

Figure 6. Output Duty Cycle (FoutDC)

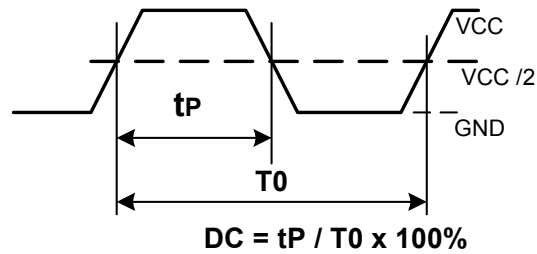
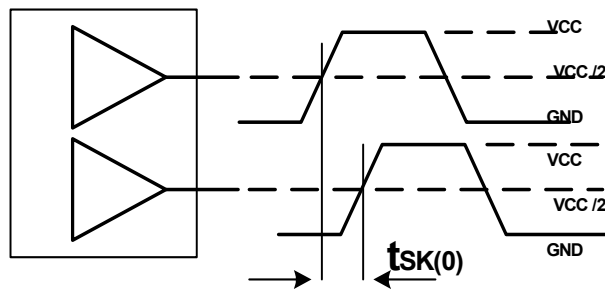

Figure 7. Output-to-Output Skew tsk(0)



### Ordering Information

Part Number	Package Type	Production Flow
CY29949AXI	52-Pin TQFP	Industrial, -40°C to +85°C
CY29949AXIT	52-Pin TQFP - Tape and Reel	Industrial, -40°C to +85°C
CY29949AXC	52-Pin TQFP	Commercial, 0°C to +70°C
CY29949AXCT	52-Pin TQFP - Tape and Reel	Commercial, 0°C to +70°C

### Package Drawing and Dimensions

Figure 8. 52-Pin Thin Plastic Quad Flat Pack (10 x 10 x 1.0 mm) A52B

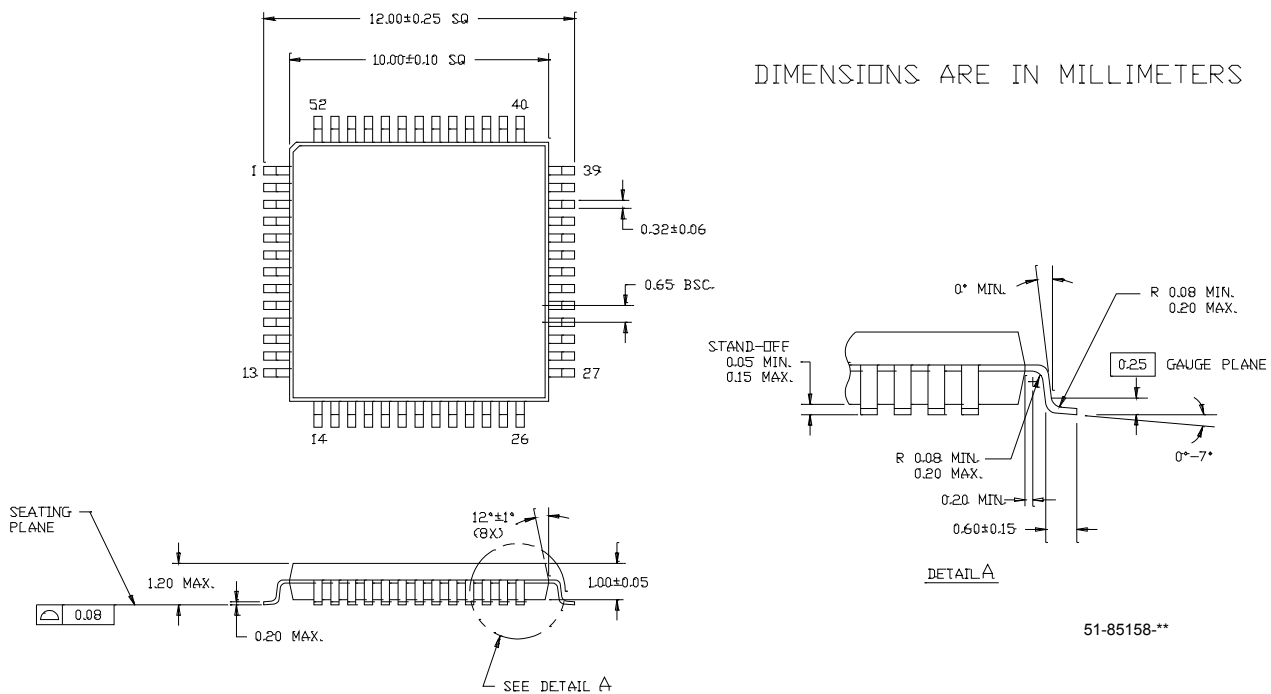

## Document History Page

Document Title: CY29949 2.5V or 3.3V 200 MHz 1:15 Clock Distribution Buffer Document Number: 38-07289				
Rev.	ECN No.	Submission Date	Orig. of Change	Description of Change
**	111100	02/01/02	BRK	New data sheet
*A	116783	08/14/02	HWT	Added commercial temperature range to the Ordering Information table
*B	118463	09/09/02	HWT	Corrected the package diagram from 52 LQFP to 52 TQFP
*C	122881	12/22/02	RBI	Added power-up requirements to Maximum Ratings
*D	130132	11/07/03	RGL	Fixed block diagram and MR/OE# description in the Pin Description table
*E	2595534	10/23/08	CXQ/PYRS	Changed to Pb-Free device code in Ordering Information

## Sales, Solutions, and Legal Information

### Worldwide Sales and Design Support

Cypress maintains a worldwide network of offices, solution centers, manufacturer’s representatives, and distributors. To find the office closest to you, visit us at [cypress.com/sales](http://cypress.com/sales).

#### Products

PSoC	<a href="http://psoc.cypress.com">psoc.cypress.com</a>
Clocks & Buffers	<a href="http://clocks.cypress.com">clocks.cypress.com</a>
Wireless	<a href="http://wireless.cypress.com">wireless.cypress.com</a>
Memories	<a href="http://memory.cypress.com">memory.cypress.com</a>
Image Sensors	<a href="http://image.cypress.com">image.cypress.com</a>

#### PSoC Solutions

General	<a href="http://psoc.cypress.com/solutions">psoc.cypress.com/solutions</a>
Low Power/Low Voltage	<a href="http://psoc.cypress.com/low-power">psoc.cypress.com/low-power</a>
Precision Analog	<a href="http://psoc.cypress.com/precision-analog">psoc.cypress.com/precision-analog</a>
LCD Drive	<a href="http://psoc.cypress.com/lcd-drive">psoc.cypress.com/lcd-drive</a>
CAN 2.0b	<a href="http://psoc.cypress.com/can">psoc.cypress.com/can</a>
USB	<a href="http://psoc.cypress.com/usb">psoc.cypress.com/usb</a>

© Cypress Semiconductor Corporation, 2002-2008. The information contained herein is subject to change without notice. Cypress Semiconductor Corporation assumes no responsibility for the use of any circuitry other than circuitry embodied in a Cypress product. Nor does it convey or imply any license under patent or other rights. Cypress products are not warranted nor intended to be used for medical, life support, life saving, critical control or safety applications, unless pursuant to an express written agreement with Cypress. Furthermore, Cypress does not authorize its products for use as critical components in life-support systems where a malfunction or failure may reasonably be expected to result in significant injury to the user. The inclusion of Cypress products in life-support systems application implies that the manufacturer assumes all risk of such use and in doing so indemnifies Cypress against all charges.

Any Source Code (software and/or firmware) is owned by Cypress Semiconductor Corporation (Cypress) and is protected by and subject to worldwide patent protection (United States and foreign), United States copyright laws and international treaty provisions. Cypress hereby grants to licensee a personal, non-exclusive, non-transferable license to copy, use, modify, create derivative works of, and compile the Cypress Source Code and derivative works for the sole purpose of creating custom software and or firmware in support of licensee product to be used only in conjunction with a Cypress integrated circuit as specified in the applicable agreement. Any reproduction, modification, translation, compilation, or representation of this Source Code except as specified above is prohibited without the express written permission of Cypress.

Disclaimer: CYPRESS MAKES NO WARRANTY OF ANY KIND, EXPRESS OR IMPLIED, WITH REGARD TO THIS MATERIAL, INCLUDING, BUT NOT LIMITED TO, THE IMPLIED WARRANTIES OF MERCHANTABILITY AND FITNESS FOR A PARTICULAR PURPOSE. Cypress reserves the right to make changes without further notice to the materials described herein. Cypress does not assume any liability arising out of the application or use of any product or circuit described herein. Cypress does not authorize its products for use as critical components in life-support systems where a malfunction or failure may reasonably be expected to result in significant injury to the user. The inclusion of Cypress’ product in a life-support systems application implies that the manufacturer assumes all risk of such use and in doing so indemnifies Cypress against all charges.

Use may be limited by and subject to the applicable Cypress software license agreement.