

Features

- 0805 size
- Magnetic shielding
- High Q characteristics
- Nickel barrier
- Lead free

Applications

- Prevention of electro-magnetic interference to signals on the secondary side of electronic equipment

Model CS201210 is currently available, although not recommended for new designs. Use Model CV201210.

CS201212 Series - Ferrite Multi-Layer Chip Inductors

Electrical Specifications

Bourns Part No.	Inductance		Q	Test Freq.	SRF MHz		DCR	I rms
	μH	Tol. %	typ.	L,Q MHz	min.	typ.	mΩ max.	mA max.
CS201212-47NK	0.047	±10	60	50	320	400	100	300
CS201212-56NK	0.056	±10	60	50	300	380	150	300
CS201212-68NK	0.068	±10	60	50	280	350	200	300
CS201212-82NK	0.082	±10	60	50	255	320	200	300
CS201212-R10K	0.10	±10	50	25	235	300	200	250
CS201212-R12K	0.12	±10	50	25	220	280	200	250
CS201212-R15K	0.15	±10	50	25	200	250	200	250
CS201212-R18K	0.18	±10	50	25	185	230	200	250
CS201212-R22K	0.22	±10	50	25	170	220	250	250
CS201212-R27K	0.27	±10	50	25	150	200	300	250
CS201212-R33K	0.33	±10	50	25	145	180	300	150
CS201212-R39K	0.39	±10	50	25	135	170	400	200
CS201212-R47K	0.47	±10	50	25	125	160	400	200
CS201212-R56K	0.56	±10	50	25	115	150	400	150
CS201212-R68K	0.68	±10	50	25	105	135	600	150
CS201212-R82K	0.82	±10	75	25	100	125	300	150
CS201212-1R0K	1.0	±10	75	10	75	105	400	100
CS201212-1R2K	1.2	±10	75	10	65	95	400	100
CS201212-1R5K	1.5	±10	75	10	60	85	400	100
CS201212-1R8K	1.8	±10	75	10	55	75	400	100
CS201212-2R2K	2.2	±10	80	10	50	70	400	50
CS201212-2R7K	2.7	±10	80	10	45	65	500	50
CS201212-3R3K	3.3	±10	80	10	40	55	500	50
CS201212-3R9K	3.9	±10	80	10	38	50	1000	50
CS201212-4R7K	4.7	±10	80	10	35	48	1300	50
CS201212-5R6K	5.6	±10	60	4	32	45	500	50
CS201212-6R8K	6.8	±10	60	4	29	40	600	25
CS201212-8R2K	8.2	±10	60	4	26	36	700	25
CS201212-100K	10.0	±10	60	2	24	33	800	25
CS201212-120K	12.0	±10	60	2	22	30	800	25
CS201212-150K	15.0	±10	40	1	19	27	1400	15
CS201212-180K	18.0	±10	40	1	18	25	1400	15
CS201212-220K	22.0	±10	40	1	16	22	700	5
CS201212-270K	27.0	±10	40	1	14	20	800	5
CS201212-330K	33.0	±10	40	0.4	13	18	1000	5

General Specifications

Temperature Rise20 °C max. at rated current
 Operating Temperature-55 °C to +125 °C
 Storage Temperature-55 °C to +125 °C
 Reflow Soldering ...230 °C, 50 sec. max.
 Resistance to Soldering Heat260 °C, 10 seconds

Materials

Base MaterialFerrite
 TerminalAg/Ni/Sn
 Packaging3,000 pcs. per reel

Product Dimensions

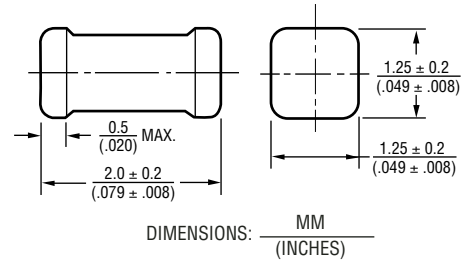

Recommended Layout

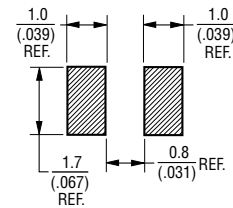

Packaging Specifications

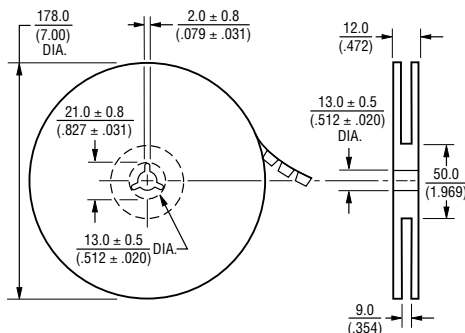

*RoHS Directive 2002/95/EC Jan 27 2003 including Annex Specifications are subject to change without notice. Customers should verify actual device performance in their specific applications.

CS201212 Series - Ferrite Multi-Layer Chip Inductors **BOURNS®**

Electrical Specifications

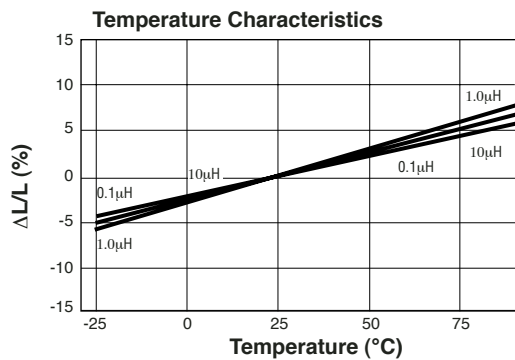
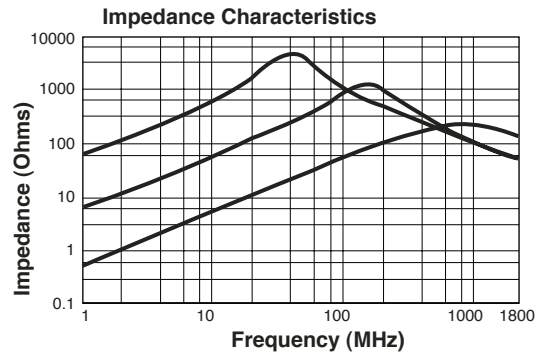
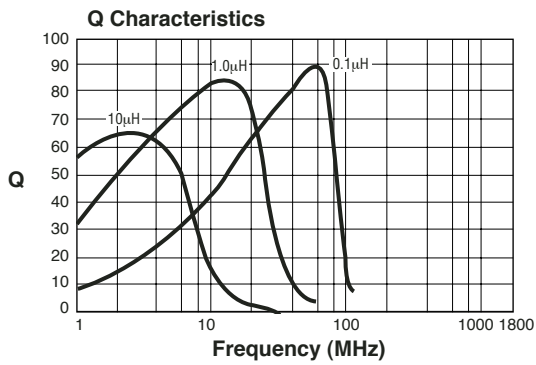
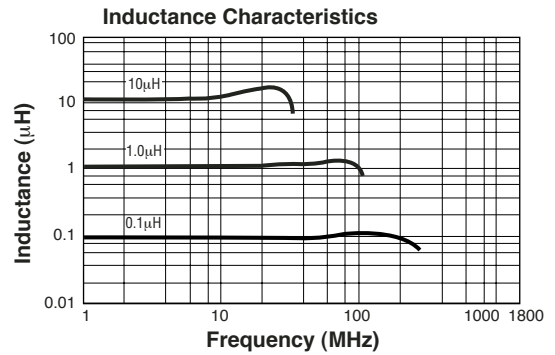
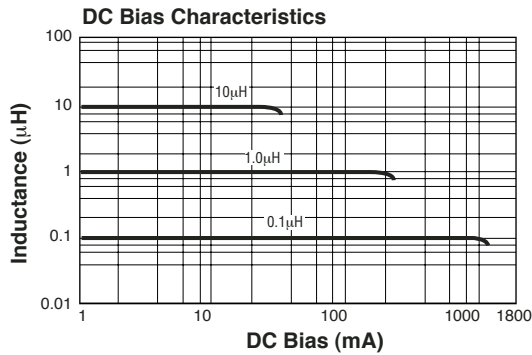

REV. 07/05

Specifications are subject to change without notice.
Customers should verify actual device performance in their specific applications.