

Noise reduction sheet (Absorptive composite electromagnetic shield material)

TDK Flexield® IRL, IRJ, IVM, IRB, IRE series

Flexield reduces radiant noise in a wide range of frequencies. This noise reduction material is superior in flexibility and processability and reduces noise particularly well in high-frequency ranges. It provides the best solution for noise reduction in the ever downsized and faster small digital devices such as Laptop computers, PDA, DVC, digital cameras, mobile phones, and the like.

Conforming to RoHS Directive

Conformity to RoHS Directive: This means that, in conformity with EU Directive 2002/95/EC, lead, cadmium, mercury, hexavalent chromium, and specific bromine-based flame retardants, PBB and PBDE, have not been used, except for exempted applications.

High flexibility offers easy handling and surfaces which are never broken or chipped.

A variety of thicknesses is available from 0.05mm up, offering mountability to thin devices with integrated circuits.

In addition to the standard sheet product, a variety of shapes and sizes are available in taped and punched products.

A diverse material product line covers a wide frequency range (10MHz to 30GHz).

Superb noise reduction characteristics in particular are provided in the high frequency range - 300MHz and up.

The product is a lead-free, environmentally friendly product. A halogen-free product is in development.

Uses

Reducing radiant noise from circuit patterns, cables, integrated components, and so forth / Reducing electromagnetic interference (resonance, cross talk, etc.) inside steel cases and between circuit blocks / Reinforcing immunity
Improving antenna receiver sensitivity / Reducing the SAR (Specific Absorption Rate) of mobile phones

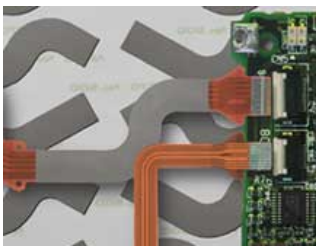

Reduction of line-circuit cross-talk

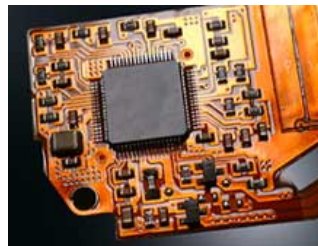

Reduction of electromagnetic inductive coupling with adjacent circuits

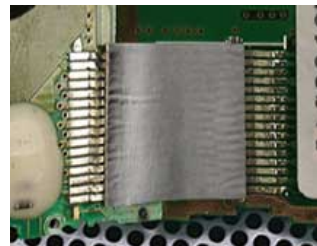

Prevention of radiant noise coupling inside chassis

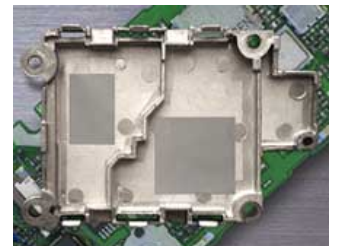

Reduction of interference inside RF circuits

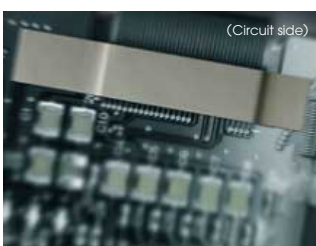

Reduction of induced electric currents on LCD shields (prevention of secondary radiation)



Reduction of interference and SAR level inside shield chassis

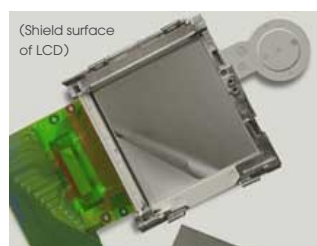

Reduction of cell phone SAR level



IRL03 sheet (0.5mm thick) is attached to back of the LCD display of cellular phones. It reduces high-frequency surface electric-currents (secondary radiant elements) induced on the shield and reduces SAR levels of the heads of cellular phone users.

Representative example of applications

- Laptop PCs / PDA devices / game consoles
- Cellular phones / PHS phones
- Digital video cameras / Digital still cameras
- CD drive / DVD players
- Liquid crystal displays
- Facsimiles / Copying machines / Printers
- High-speed interface devices
- Car navigational systems
- Optical communication devices
- Optical transmission modules
- Measuring equipment
- Experimental apparatuses / ISM devices
- ATM (asynchronous transfer mode) exchange
- Cellular phone
- PHS base stations
- ITS-related units, devices

TDK Flexield.
IRL, IRJ, IVM,
IRB, IRE materials

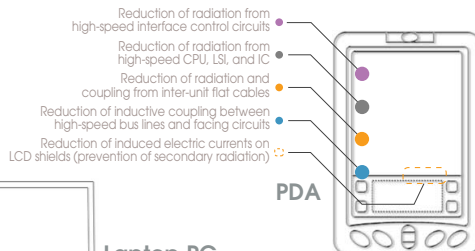
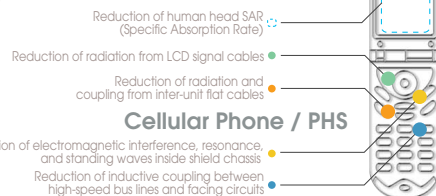
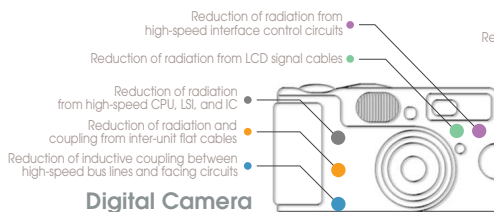
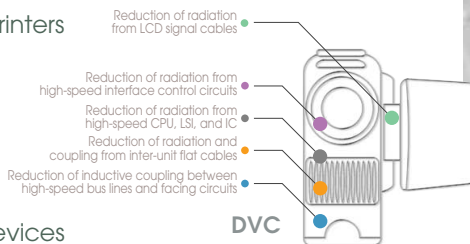
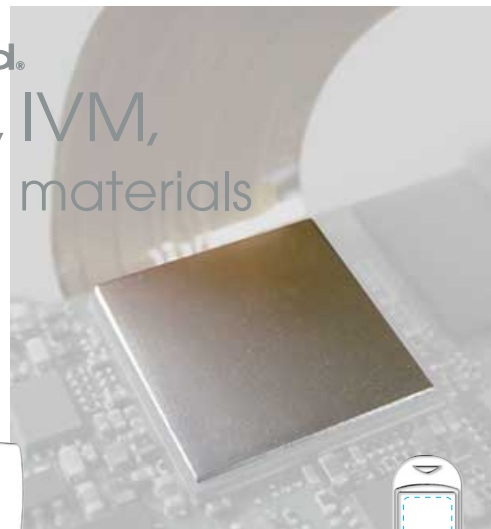

Laptop PC

Material lineup

Method of naming the products

IRL02 □ □ □ □ **H 200 x 200 x 1**

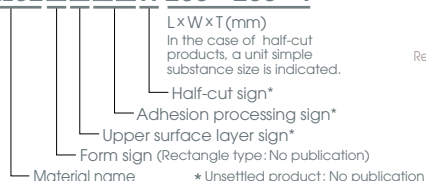

Standard material characteristics/specifications

| Type (Feature/Use) | Standard/wide band | | | | High performance/wide band | | | |
|---|----------------------|-----------|-----------|-----|----------------------------|-----|----------------------|-----------|
| Material name | IRL02 | | IRL03 | | IRL04 | | RL05 | |
| Recommended frequency | 100MHz to 10GHz | | | | 50MHz to 10GHz | | | |
| Operating temperature range (°C) | -40 to +85 | | | | -40 to +85 | | | |
| Initial permeability μ_i (at 10MHz) | 20 min. | | | | 30 min. | | | |
| Resistivity (Ω/\square) | 1M min. | | | | 10k min. | | | |
| Thermal conductivity (W/mK) | 1.4 | | | | 1.5 | | | |
| Standard sheet shape (mm) | 200 x 200 | 300 x 200 | 300 x 200 | | 300 x 200 | | | 300 x 200 |
| Standard sheet thickness (mm) | 1.0 | 2.0 | 0.05 | 0.1 | 0.25 | 0.5 | 0.25 | 0.5 |
| Standard sheet weight (g) | 100 | 200 | 10 | 20 | 50 | 100 | 50 | 100 |
| Density (g/cm ³) | 3.2 | | 2.5 | | 3.4 | | 3.3 | |
| Fire-resistant standard | — | | | | ** | | | |
| Environmentally friendly | RoHS* & halogen-free | | | | RoHS* | | RoHS* & halogen-free | |

** UL94 standard acquisition product is also prepared.

| Type (Feature/Use) | Heat-resistance | High insulation/ burn resistant | | For Semi-micro waveband | For GHz wavebands | | |
|---|----------------------|---------------------------------|------------------|-------------------------|----------------------|-----|------|
| Material name | IRJ01 | IVM05 | IVM06 | IRB02 | IRE02 | | |
| Recommended frequency | 100MHz to 10GHz | 100MHz to 3GHz | 100MHz to 3GHz | 500MHz to 5GHz | 3 to 30GHz | | |
| Operating temperature range (°C) | -40 to +125 | -40 to +85 | -40 to +85 | -40 to +70 | -40 to +70 | | |
| Initial permeability μ_i (at 10MHz) | 18 min. | 7 min. | 12 min. | 6 min. | 4 min. | | |
| Resistivity (Ω/\square) | 1M min. | 1G min. | 1G min. | 1M min. | 1M min. | | |
| Thermal conductivity (W/mK) | 1.0 | 1.2 | 1.3 | 1.2 | 0.8 | | |
| Standard sheet shape (mm) | 250 x 250 | 300 x 200 | 300 x 200 | 300 x 300 | 300 x 300 | | |
| Standard sheet thickness (mm) | 0.5 | 0.4 | 0.4 | 1.0 | 2.0 | 3.0 | 6.0 |
| Standard sheet weight (g) | 85 | 80 | 80 | 300 | 600 | 900 | 1800 |
| Density (g/cm ³) | 2.5 | 3.3 | 3.3 | 3.3 | 3.75 | | |
| Fire-resistant standard | Acquired UL94V-0 | Acquired UL94V-0 | Acquired UL94V-0 | — | — | | |
| Environmentally friendly | RoHS* & halogen-free | RoHS* & halogen-free | RoHS* | RoHS* & halogen-free | RoHS* & halogen-free | | |

Examples of diverse manufacturing processing

TDK Flexield.
IRL, IRJ, IVM,
IRB, IRE materials

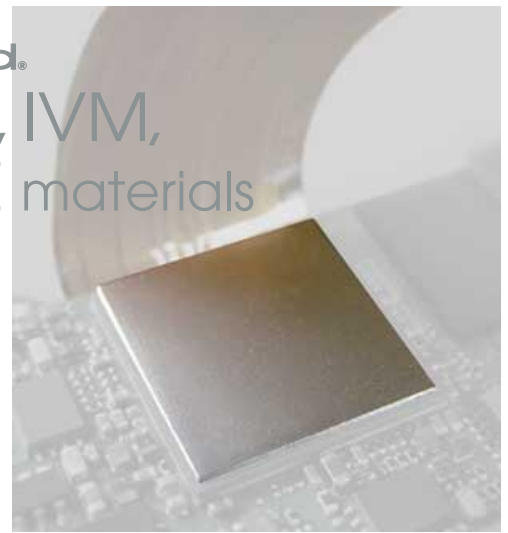

Half-cut, adhesive sheet processing

Rectangular, adhesive sheet processing

Example: for flexible I/O cable connecting integrated circuits in digital cameras

Die-cut processing

Example: for high-frequency signal transmission line connectors

Long tape processing/long adhesive-tape processing (IVM05,06)

Supplied through small-shaped taping

Example: Die-cut products for information terminal devices (IRB)

Large adhesive-sheets with diverse-shaped products

Example: Large sheets for large devices



Example of rectangular adhesive sheet processing

For flexible I/O cable connecting integrated circuits in digital cameras

Example of half-cut adhesive sheet processing



Adhesive-sheet processing is available for all products



Taping specifications can be provided for small-shaped products.

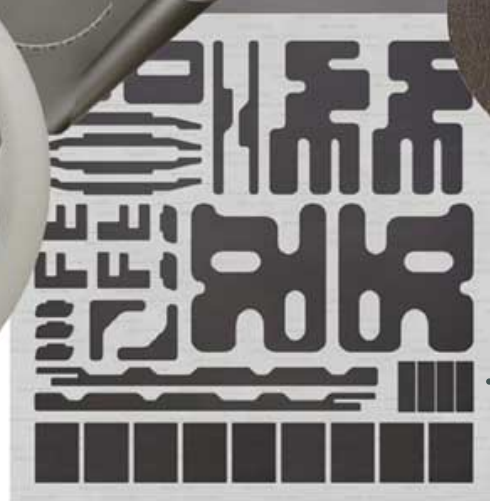

Example of die-cut products using the IRB material

For high-frequency signal transmission line connectors

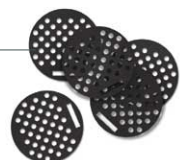

The IVM05, 06 materials can be processed as long tapes. Adhesive-tape processing is also available.

Products in various shapes mounted to a large device can be provided in large size double-sided processed sheets.

Basic characteristics

Flexield is a multiple magnetic sheet composed of polymer and our proprietary magnetic powder. As well as magnetic characteristic materials that are ideal for different uses, our product line includes materials with increased insulative properties, flame resistance, and heat resistance.

Flexield, with its electromagnetic loss mechanism and magnetic shield feature, provides the following three chief reduction effects:

TDK Flexield.
IRL, IRJ, IVM,
IRB, IRE materials

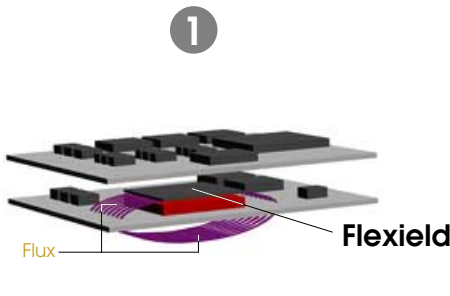
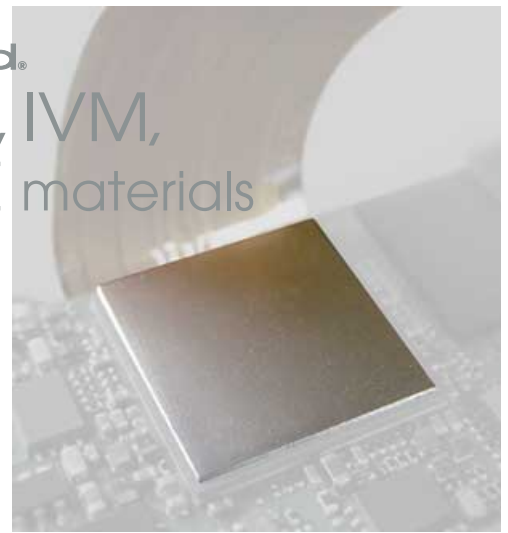

Reduces the opposite line of high-frequency magnetic-field elements occurring due to signal lines and ICs inside devices, and reduces inductive coupling of cohesive units (The decoupling effect).

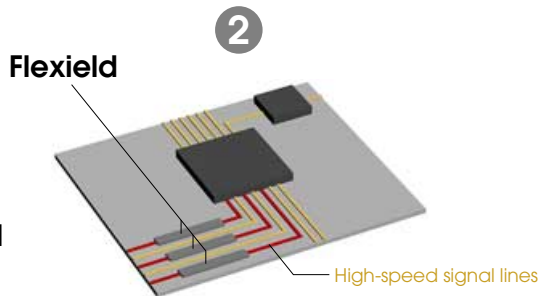

Reduces the effects of high-frequency elements by adding impedance to signal lines (The filter effect).

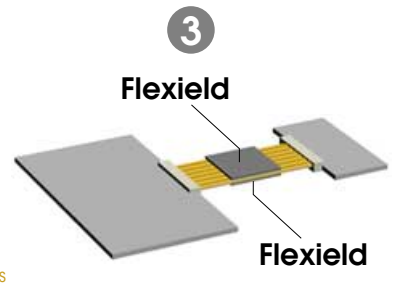

Reduces the common-mode electrical current elements superposed in the flexible cables connecting high-speed circuits and the like.

Measurement results using reappearance models of these three representative cases are shown in an attachment.

Measurement items / models

1

Measuring the decoupling effect

Reduction effect of the neighboring magnetic field in microstriplines

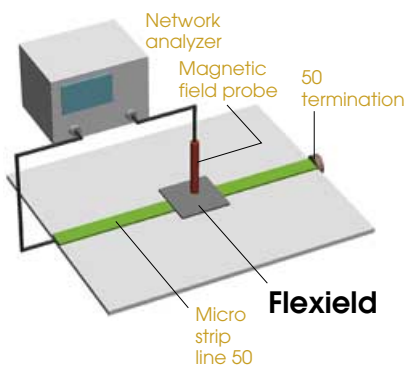

2

Measuring the filter effect

Decremental effect of the transmission signal in microstriplines

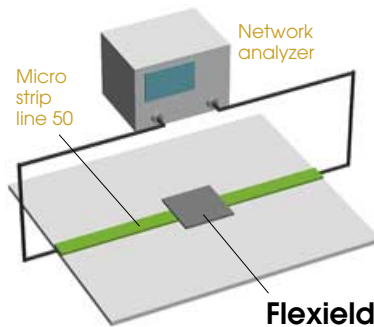

3

Measuring common-mode electrical current reduction effect

Decremental effect of the transmission signal in coaxial lines

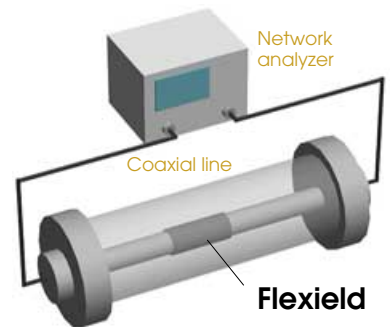

Example of decremental effect

Measurement results using reappearance models

The data shown here are examples of in-house measurement and may not coincide with performance in other situations.

TDK Flexield.

IRL, IRJ, IVM, IRB, IRE materials

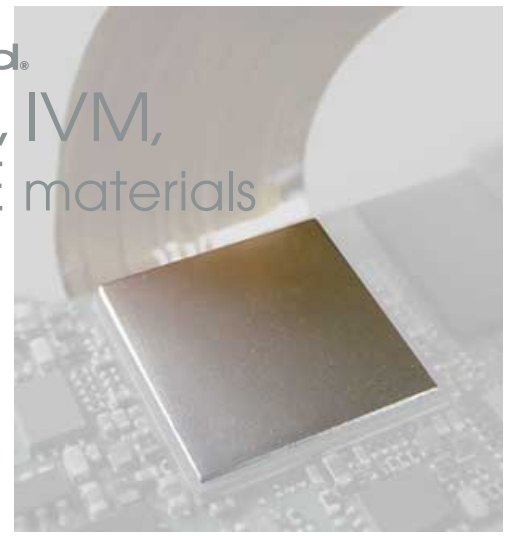

The numerical value attached to the line of graph is the thickness of each sheet.
 Damping ratio (dB) = S21 (dB) Without Flexield - S21 (dB) with Flexield

Measuring the decoupling effect

Example of the reduction effect of the neighboring magnetic field in microstriplines

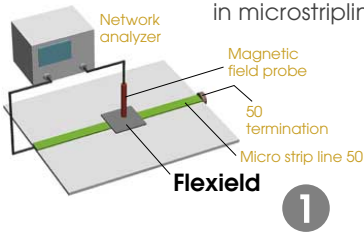

IRL02, IRL03

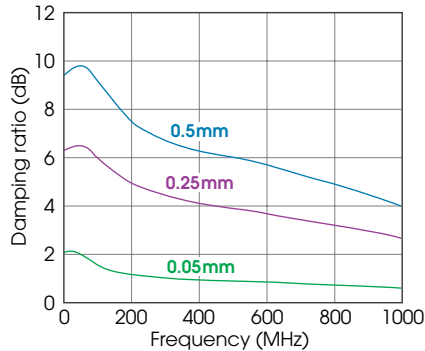

IRL04

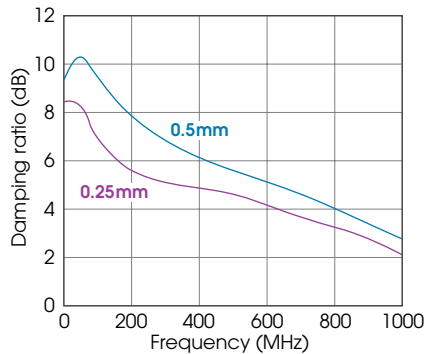

IVM06

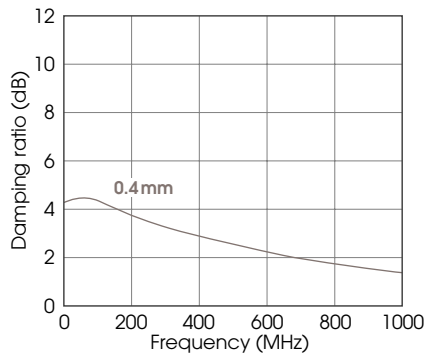

Measuring the filter effect

Example of decremental effect of the transmission signal in microstriplines

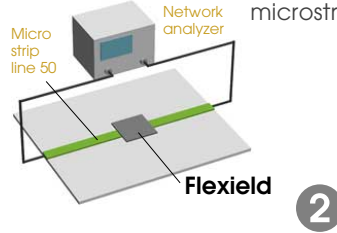

IRL02, IRL03

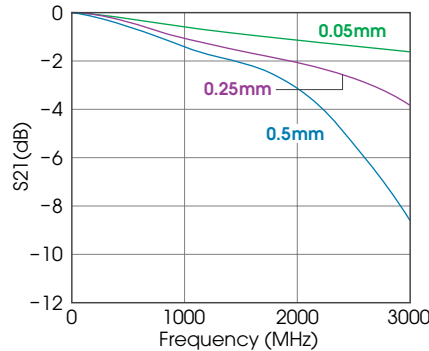

IRL04

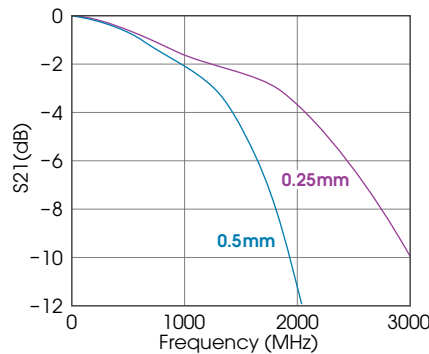

IVM06, IRB02

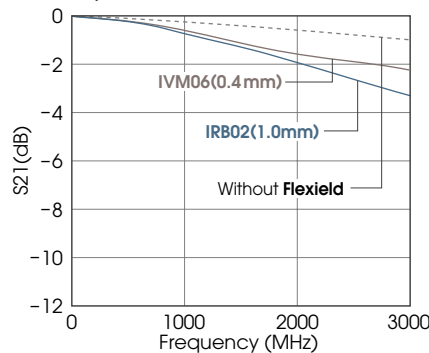

Measuring common-mode electrical current reduction effect

Example of decremental effect of the transmission signal in coaxial lines

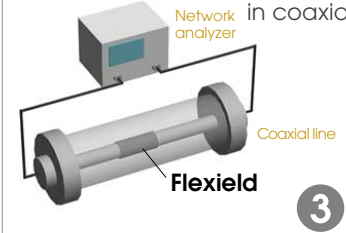

IRL02, IRL03

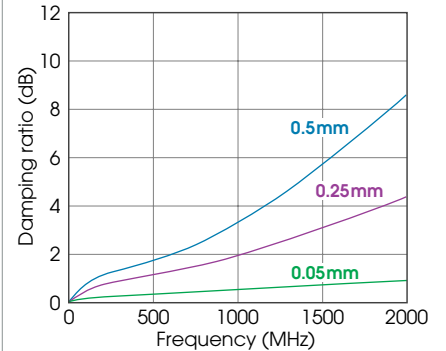

IRL04

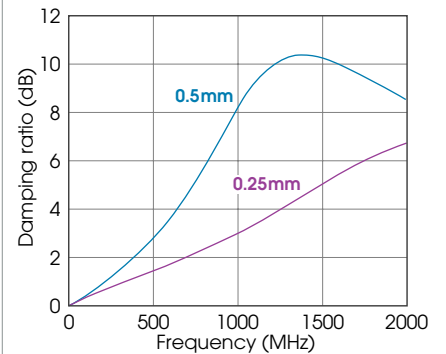

IVM06, IRB02

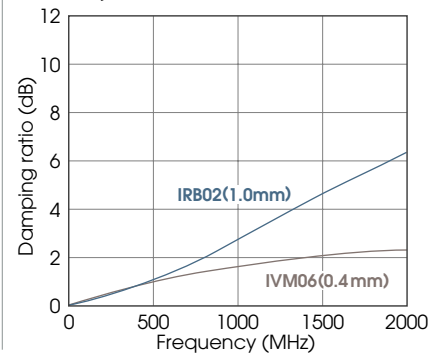

Example of the improved reception of mobile phones

The data shown here are examples of in-house measurement and may not coincide with performance in other situations.

With the increased number of features in mobile phones, their packaging density has greatly increased. As the circuit speeds are accelerated, sources of malfunctions, such as electromagnetic interferences between circuit units, and deterioration of communication quality caused by coupling, become further complicated.

In particular, FPC, which connects circuit units, tends to act as an antenna which radiates high frequencies. FPC, which connects the color TFT liquid crystal panels and drives of mainstream foldable mobile phones, is designed to be contained in the hinges and to be extended. This runs the risk of emitting high-frequency elements coupled with the visual signals (currents), and also with neighboring circuits such as the RF units. If radiated electromagnetic waves interfere with the transmitting and receiving antenna, damage to communication quality (reception sensitivity) will be considerable.

The electromagnetic loss feature and magnetic shield feature of Flexield works effectively for these cases and improves receptive sensitivity. Following is an example of how receptive sensitivity improves when Flexield is applied to FPC connecting the color TFT liquid crystal panels and drives.

Putting 0.05mm IRL02 material cut in 7x7mm square on the driver and only one side of the LCD's FPC terminal resulted in an improved receptive sensitivity of 4.5dB.

TDK Flexield.
IRL, IRJ, IVM,
IRB, IRE materials

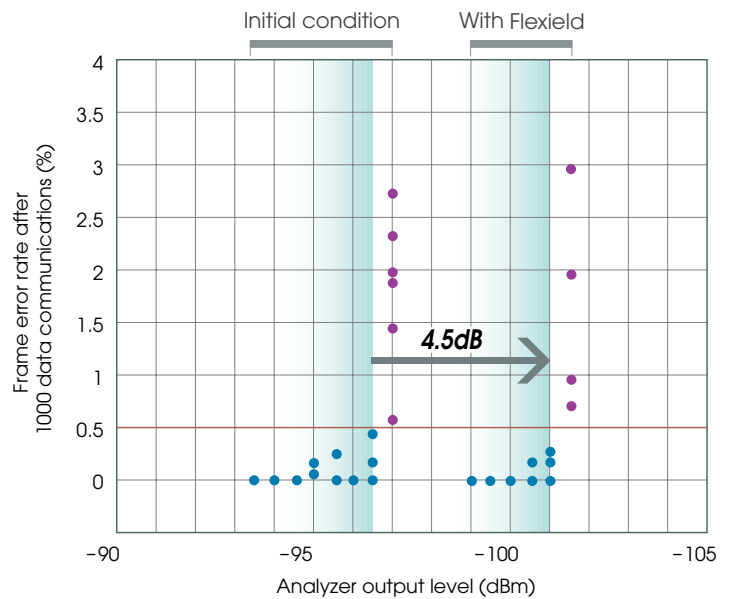

Measurement system

Measurement environment: Fully anechoic chamber

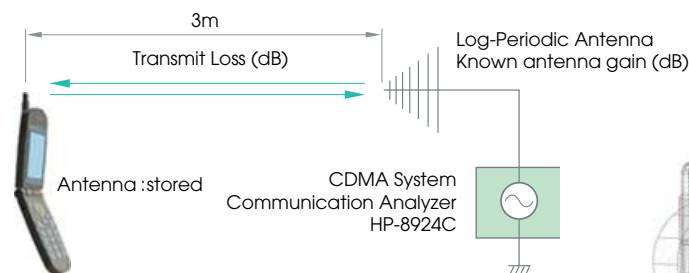

IRL02

T: 0.05mm / 7 x 12mm / Putting on one side



FPC connects the main LCD and LCD drivers. For mobile phones, this is a rather lengthy signal line.

IRL02
T: 0.05mm
7 x 12mm
Putting on one side

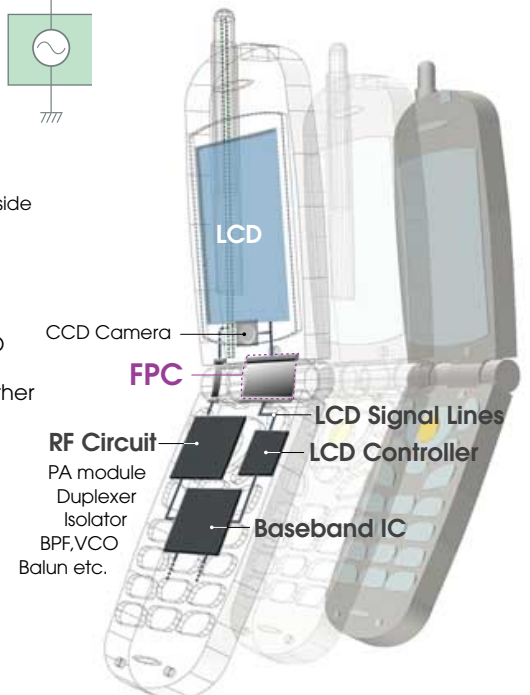

Example of preventing unnecessary radiations by mobile phones

The data shown here are examples of in-house measurement and may not coincide with performance in other situations.

Using Flexield inside mobile phones not only prevents internal interferences, but is also very effective as a countermeasure to unnecessary radiation. The following examples show how effective it is:

We evaluated a mobile phone's electrical field radiation strength level between 300 and 1000MHz and observed radiation exceeding the permissible value of the VCCI class B in addition to the 900MHz carrier frequency.

The frequency measured with the horizontal polarized wave in accordance with the 3m regulation was 750MHz. With this figure, it was assumed that the radiation source would be the VCO installed in the RF circuit. A 0.05mm-thick IRL02 material, which was cut 8mm wide, and 10mm long on the side of the case where VCO faces, was then attached.

The following chart shows the result. The electric field strength peak level at issue was reduced by about 2.5dB, complying with the VCCI class B standard.

Initial condition

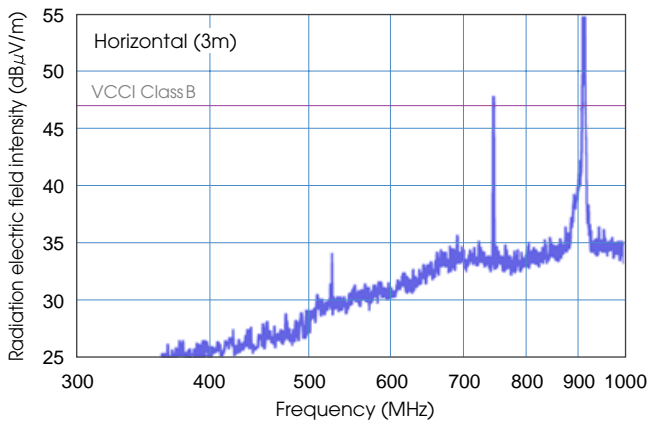

With Flexield

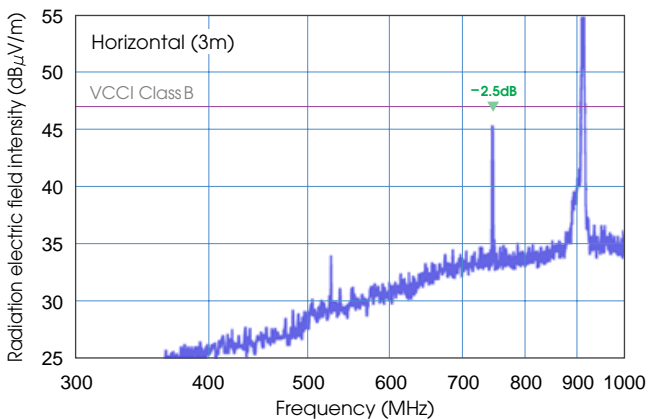

TDK Flexield.

IRL, IRJ, IVM,
IRB, IRE materials

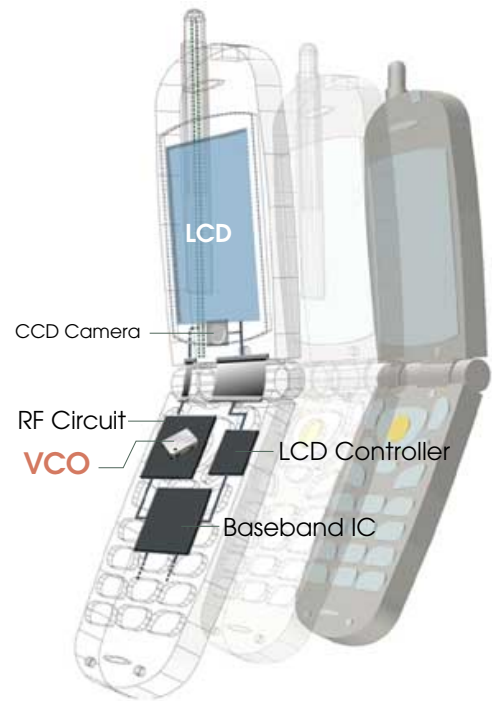

Example of the LCOS module's countermeasure against unnecessary radiation

The data shown here are examples of in-house measurement and may not coincide with performance in other situations.

Efforts to develop microdisplays with higher resolutions and lower costs have been accelerated. Examples of countermeasures against unnecessary radiation will be shown for large projection TVs (which are in increasing demand, chiefly in North America) and the LCOS modules integrated in projectors which have been further downsized at reduced cost. These examples reflect the increased demand for audio and visual devices for home and business.

The chart below shows results of measurements. There's also a result for the case where the LCOS modules are removed in order to measure the radiation level of the control board. The chart at the bottom right shows the measurement of unnecessary radiation with Flexield applied to a part of the FPC between the LCOS and circuit. The FPC is placed between two sheets of a 0.5mm-thick IRL03 material cut a few millimeters wider than the width of the FPC.

Under the initial conditions, before application, there was a steep noise increase approaching the regulatory value of the FCC class B between 500 and 1000MHz (exceeded the value around 600MHz). After it was applied, a reduction of about 5-10dB was observed in a wide range of frequencies.

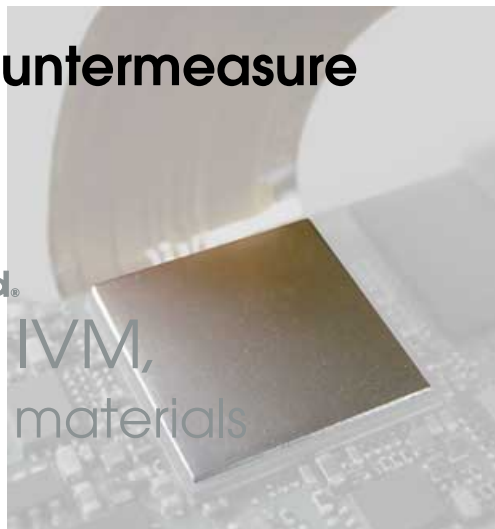

TDK Flexield.
IRL, IRJ, IVM,
IRB, IRE materials

Circuit board only (LCOS modules are not connected)

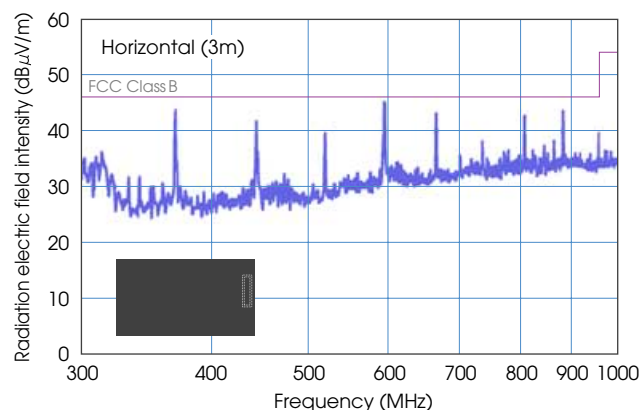

Circuit board + LCOS module

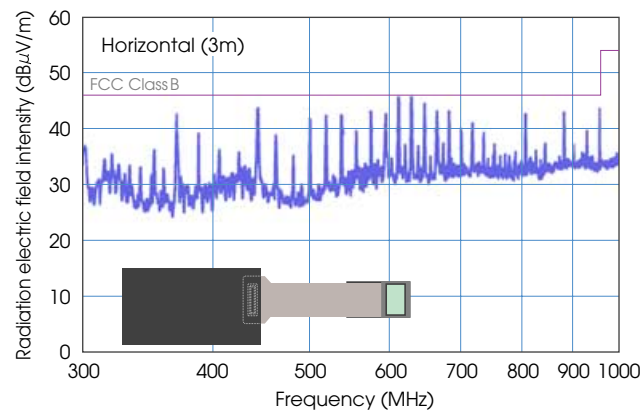

Circuit board + LCOS module with Flexield

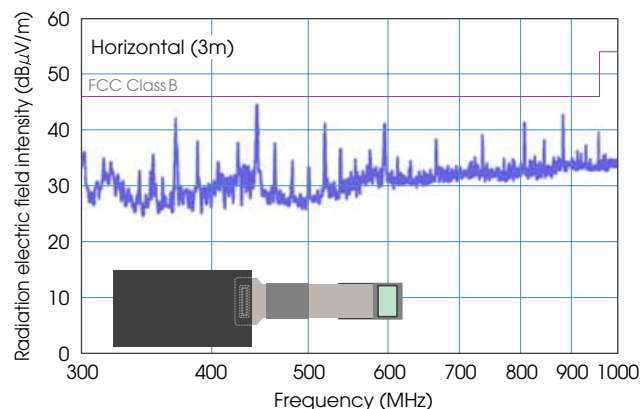

Example of DVC's countermeasure against unnecessary radiation

The data shown here are examples of in-house measurement and may not coincide with performance in other situations.

Along with the outstanding advancement of digital circuits, efforts are being made to develop smaller and faster digital devices like DVCs and DSCs. Developments using three-dimensional high-density structures and high-speed interfaces are also underway, and efforts here are taking place at an increased speed.

Sophisticated and precise designs posed limitations on the conventional EMI countermeasure methods using noise-reducing components, shields, and the grounding method.

Flexield offers the advantage of solving problems without modifying the basic design in the case of unexpected events during the final stages of device development. The electromagnetic loss and magnetic shield effects of Flexield can greatly reduce the noise elements previously irremovable with conventional components and methods.

For instance, in this evaluation of a small digital camcorder, we installed 0.05-0.5mm-thick IRL02 and IRL03 material sheets in such places as on the small circuit (two locations) where visual signals from the CCD are processed at high speed ①; on the FPC ②; on the top of the controller IC where the FPC are close together when installed in the circuit board ③; on the surface of the LSI on the unit board ④; on the surface of the FPC connecting circuits; and so forth, a total of fourteen sites. These locations are suspected to be the source of high-frequency radiation, and the secondary radiation due to coupling inside the case. As a result, unnecessary radiation between 200 and 1000MHz was reduced by 2-7dB, including the steep noise elements which had previously exceeded the VCCI class B regulational value. It was also confirmed that this method would cause no deterioration of the unit's basic functions, features, and errors.

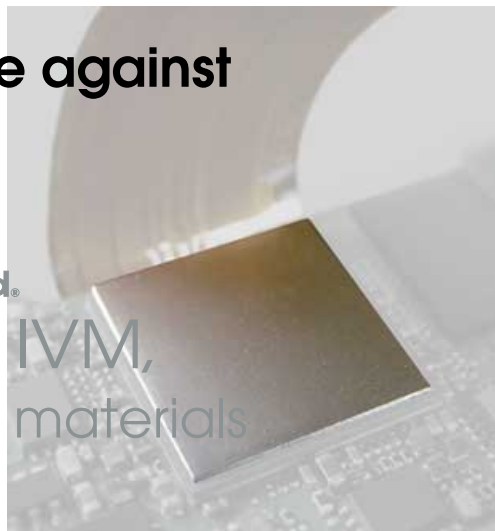

Initial condition

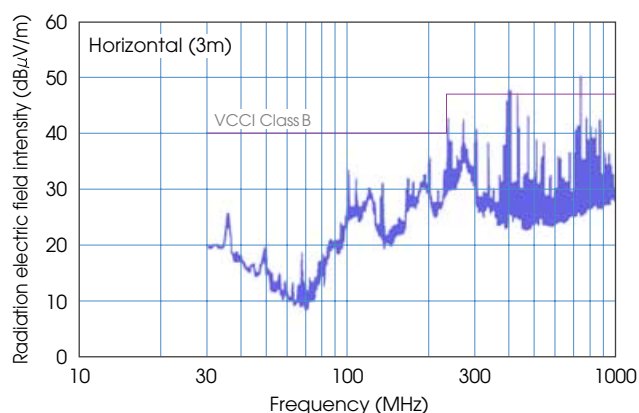

With Flexield

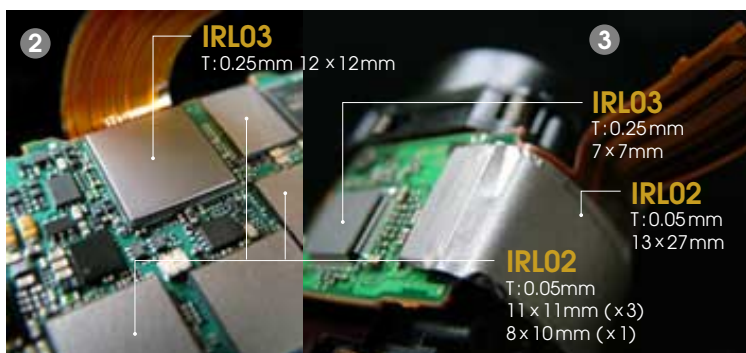
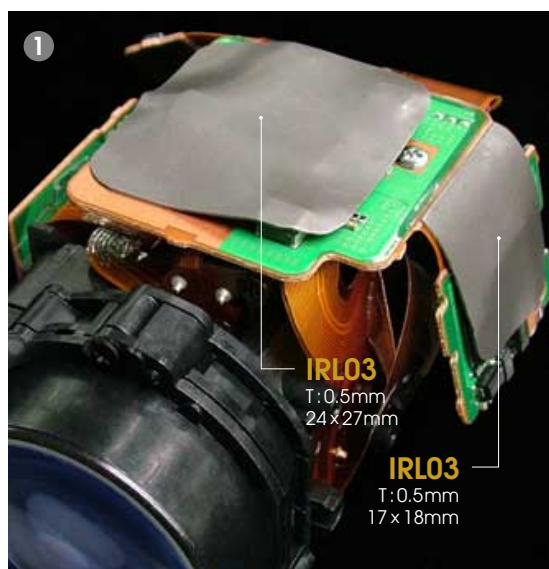
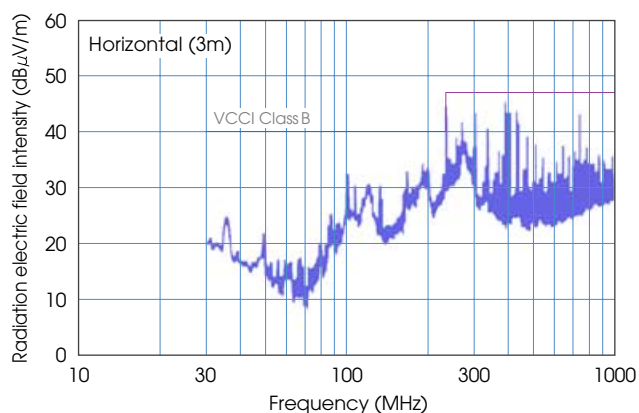

Example of an optical pickup's countermeasure against unnecessary radiation

The data shown here are examples of in-house measurement and may not coincide with performance in other situations.

Many optical pickup units used in DVD players, and the like, drive laser diodes using a superposed 400MHz high-frequency electric direct current. This superposed electrical current includes high-frequency elements reaching GHz areas, which may run the risk of radiation of strong, high-frequency noise from the FPC and circuit boards, depending on the pattern position of the power source line and the grounding method.

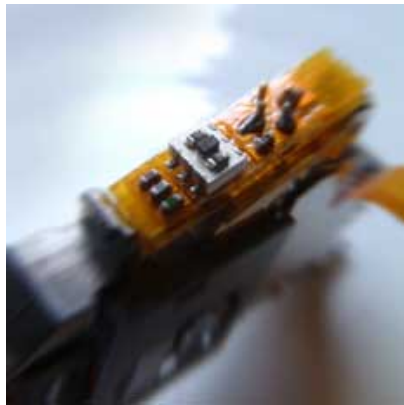

High-frequency superposed module installed in an optical pickup

The following example shows the effectiveness of a countermeasure using the test drive circuit where a DVD/CD optical pickup unit is driven in the DVD mode. The IRL02 material, which has a superb noise absorption characteristic between 100MHz and 10GHz was used. Its adhesive 0.05-thick sheet was cut 10mm wide and wrapped around the end of the FPC once on the optical pickup side.

As a result, the higher harmonic wave elements often seen in GHz bands were reduced by 6-7dB (13dB in 1GHz area) in a wide range of frequencies, as were the basic waves.

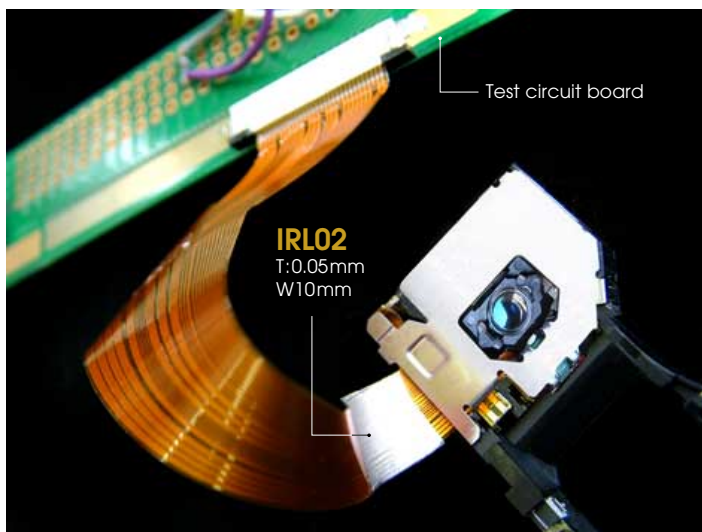

TDK Flexield.
IRL, IRJ, IVM,
IRB, IRE materials

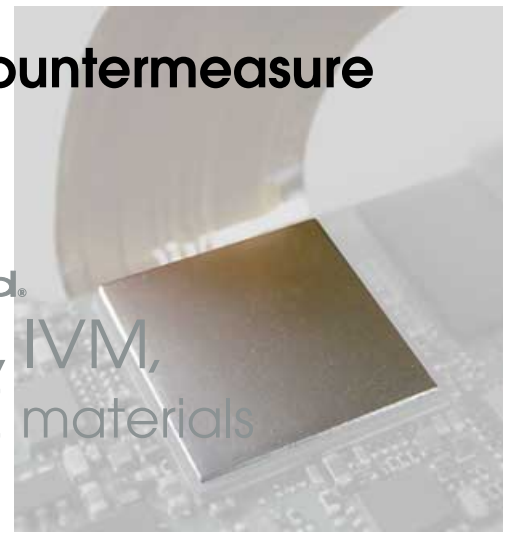

Initial condition

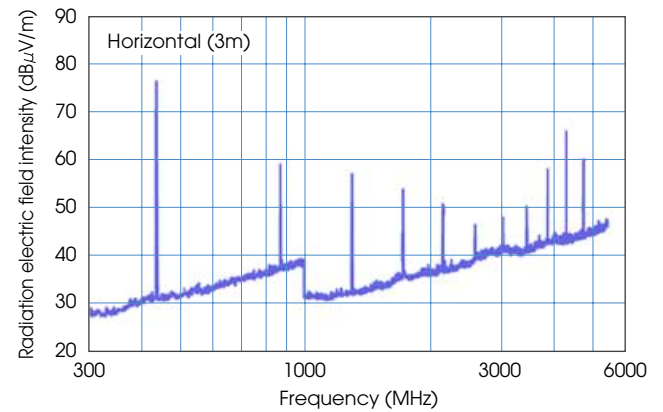

With Flexield

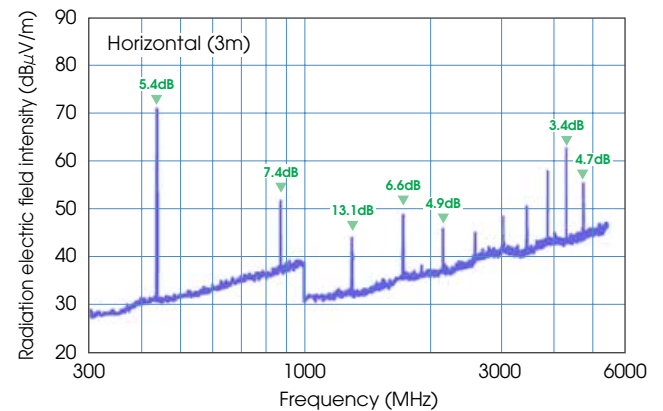

Example of SAR reduction in a mobile phone

The data shown here are examples of in-house measurement and may not coincide with performance in other situations.

Currently, legislation to regulate the SAR (Specific Absorption Rate) of mobile phone radiation potentially damaging to the human head (Less than 2W/Kg in Japan) is underway globally. By using Flexield at appropriate positions for large magnetic shield and electromagnetic loss effects, highly efficient SAR countermeasures, which don't damage the far electrical field strength that determines transmission and reception performance, can be expected.

The following example shows the benefits of SAR reduction using a simulated mobile phone with the carrier wave set at 900MHz. In this case, Flexield was applied to the back of the liquid crystal panel. SAR reduction of more than 30% was achieved.

The decline of the far electric field level was less than a few percent, and it was confirmed that practical transmission performance could be maintained.

If the application of sheet Flexield for SAR reduction using punched Flexield shapes is considered when designing a mobile phone, optimum materials, shapes, sizes (thickness and area), and locations, can be determined in a most effective manner.

TDK Flexield.
IRL, IRJ, IVM,
IRB, IRE materials

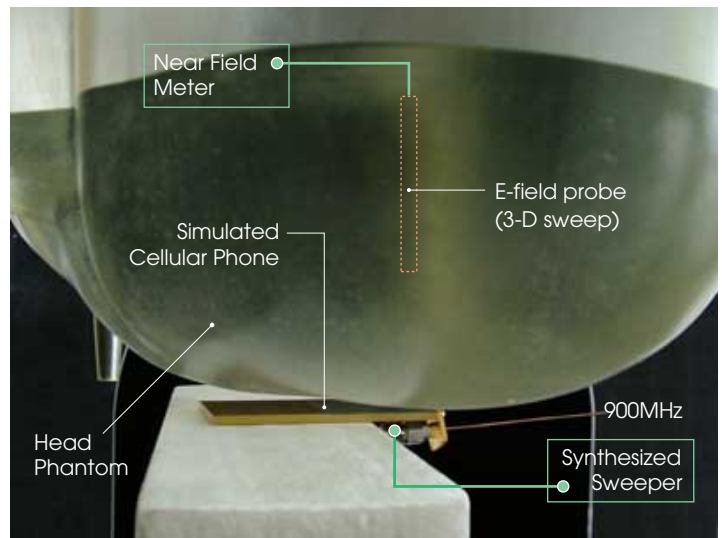

Conditional change of the far electric field

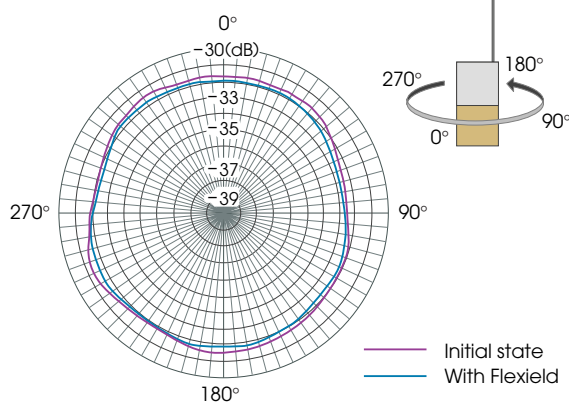

IRL03
T:0.5mm
40 x 40mm

