

MOD-GSM-EDGE development board Users Manual



All boards produced by Olimex are ROHS compliant

Rev. Initial, March 2011
Copyright(c) 2011, OLIMEX Ltd, All rights reserved

INTRODUCTION

MOD-GSM-EDGE, connected to other Olimex board with UEXT connector is excellent choice for adding remote monitoring and control in remote places by GSM cellular network. Depending on the features of the other board, for example, you can transfer digital data, measure analog values, connect to internet by GSM network. MOD-GSM-EDGE can be connected to computer via on-board mini USB connector. Also the board can work in standalone mode, but only when the SIM card is without PIN code. In standalone mode MOD-GSM-EDGE requires usage of AT commands. It can receive information by GSM network, but if you want to operate with this information, you will need appropriate board with UEXT connected to MOD-GSM-EDGE. Choose the other board depending on the application you want to have. MOD-GSM-EDGE contains SIM700D - quad-band GSM GPRS/EDGE module 850/900/1800/1900Mhz inside which covers most used GSM networks around the world. SIM700D supports EDGE protocol which assures faster data transfer. The GSM antenna is built in the board so no need for external expensive GSM antennas.

BOARD FEATURES

- SIM700D - GSM/GPRS/EDGE quad-band MODULE
850/900/1800/1900Mhz with build on-board GSM cellular antenna
- Li-ion backup battery 3.7 V 1200mA for up to 200 hours of GSM module stand-by
- SIM-card holder
- USB mini interface
- Status LED
- On-GSM module temperature sensor
- UEXT connector
- PWR_EXT connector
- PWRKEY button
- On-board DC-DC converter for standalone mode and battery charger
- PCB: FR-4, 1 mm (0,039"), solder mask, silkscreen component print
- Dimensions: 79.2x57.6 mm (3.118x2.268")

ELECTROSTATIC WARNING

The MOD-GSM-EDGE board is shipped in protective anti-static packaging. The board must not be subject to high electrostatic potentials. General practice for working with static sensitive devices should be applied when working with this board.

BOARD USE REQUIREMENTS

- Hardware:** 12V, 800mA Power Supply, if you want to recharge the battery.
An Olimex board with UEXT.
Mini USB cable.
- Important:** If your board does not work, first try to charge the battery as you power supply the board for few hours.

MODULE FEATURES

- Power Supply - Single Supply voltage 3.4V - 4.5V
- Power saving - Typical power consumption in SLEEP mode (BS-PA-MFRMS=5) is 4mA
- Frequency bands:
 - Quad-band: GSM 850, GSM 900, DCS 1800, PCS 1900.
 - Compliant to GSM Phase 2/2+
- GSM class - Small MS
- Transmit Power
 - GMSK:
 - Class 4 (2W)@GSM850/GSM900
 - Class 1 (1W)@DCS1800/PCS1900
 - 8PSK:
 - Class E2 (0.5)@GSM850/GSM900
 - Class E2 (0.4W)@DCS1800/PCS1900
- GPRS connectivity
 - Multi-slot class 12
 - Coding scheme: CS1~4
 - Mobile station class B
- EDGE connectivity
 - Multi-slot class 12
 - Modulation and coding scheme: MCS1~9
 - Mobile station class B
- DATA transfer
 - CSD: up to 9.6kbps, support non-transparent and transparent mode
 - GPRS: downlink max: 85.6kbps; uplink max: 85.6kbps
 - EDGE: downlink max: 236.8kbps; uplink max: 236.8kbps
 - Coding scheme: CS1~4, MCS1~9
 - Support PBCCH
 - Support USSD
- TCP/IP protocol stack - Access by AT commands
- Temperature range
 - Normal operation: -20°C to +60°C
 - Restricted operation: -30°C to -20°C and +60°C to +80°C ⁽¹⁾
 - Storage temperature: -40°C to +85°C
- SIM interface - Support SIM card: 3V and 1.8V
- External antenna - connected via 50 Ohm antenna pad

- Audio features
 - Speech codec modes:
 - Half Rate (ETS 06.20)
 - Full Rate (ETS 06.10)
 - Enhanced Full Rate (ETS 06.50/06.60/06.80)
 - Echo Cancellation
 - Noise reduction
 - AMR
- Main serial port
 - Seven lines on Main serial Port
 - CSD FAX, GPRS/EDGE services
 - AT commands of controlling module
 - Multiplexing function
 - Autobauding baud rate
- USB interface - support an USB 2.0 Full Speed (12Mbit/s) device interface
- Phonebook management - support phonebook types: SM, LD, MC, RC, ME, ON, VM, LA, DC, SD, FD, BN
- SIM Application Toolkit - support SAT class 3, GSM 11.14 Release 99
- Real Time clock - implemented
- Timer function - Programmable via AT commands
- Physical characteristics
 - Size: 43.5x26x2.9 mm
 - Weight: 7g
- Firmware upgrade - via main serial port or USB interface

(1) SIM700D works, but deviations from GSM specification may cause errors.

FUNCTIONAL DIAGRAM

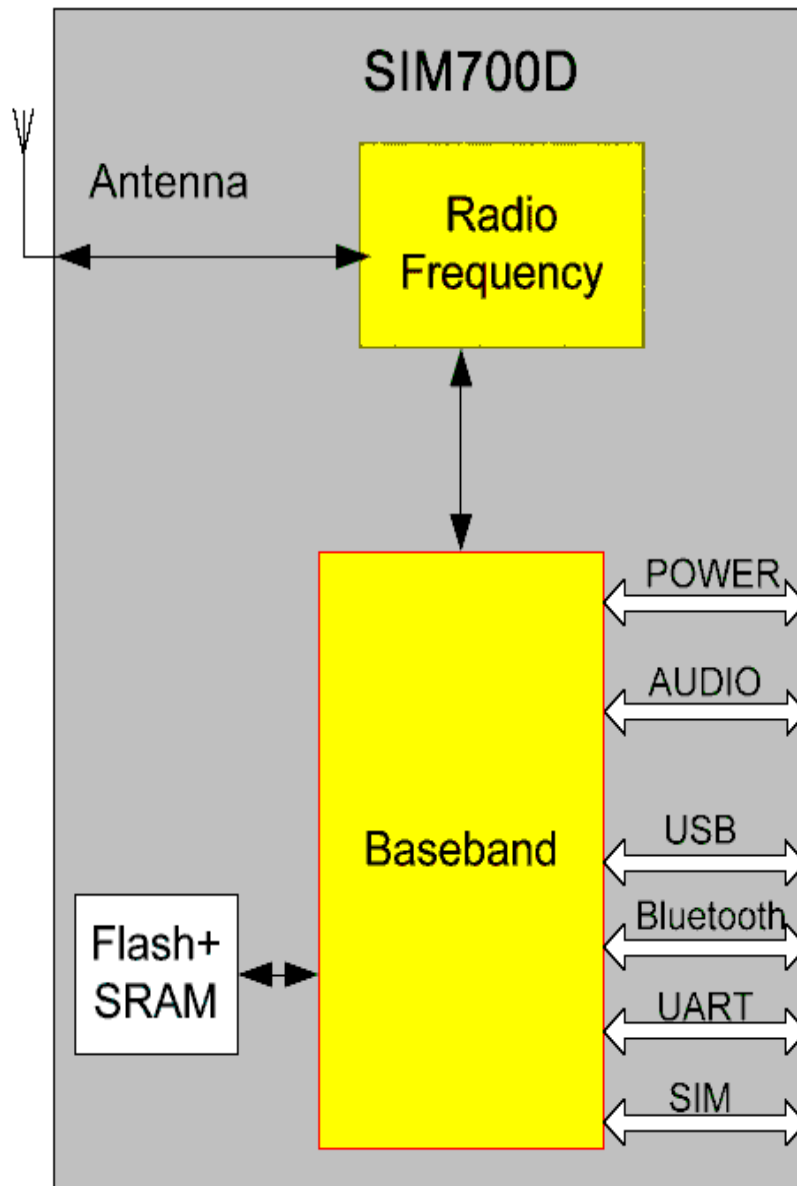

SCHEMATIC

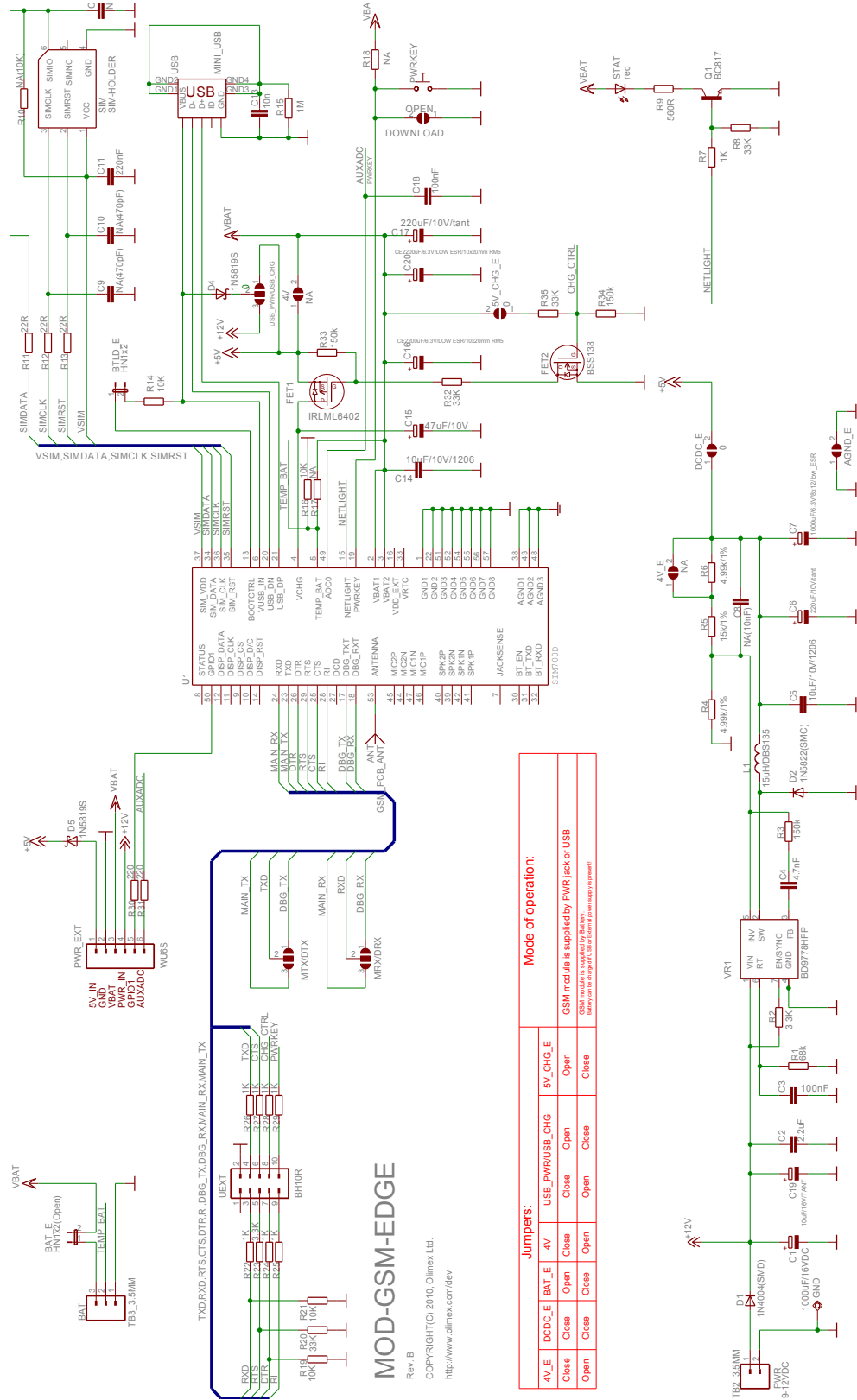

BOARD LAYOUT

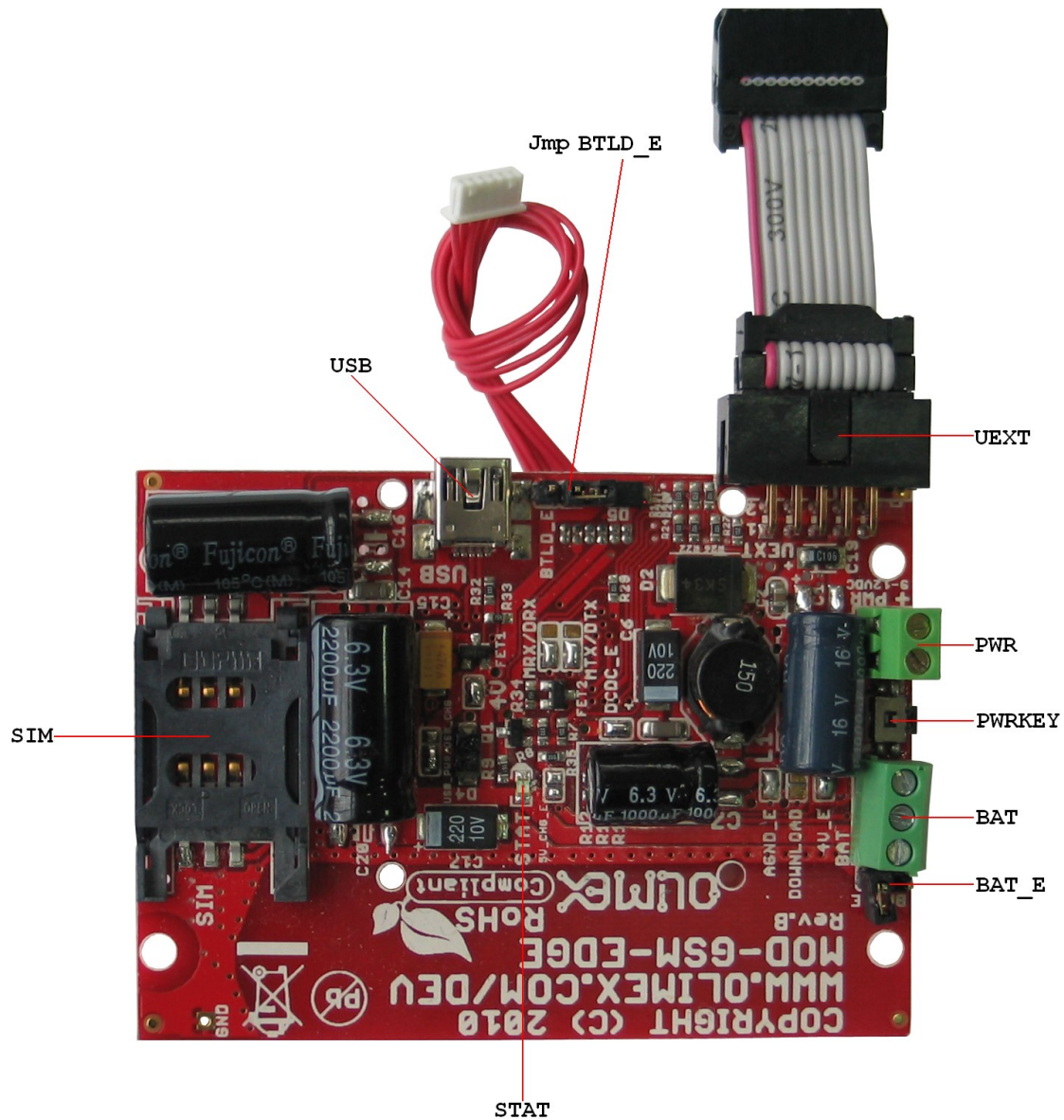



POWER SUPPLY CIRCUIT

The MOD-GSM-EDGE board may be supplied in different ways:

1. External power supply (+9 - 12VDC), or USB power supply without using the internal backup battery.

The module is powered only from external 12V and the battery is not connected. In this case:

- jumper BAT_E must be open
- jumper 4V_E must be closed
- jumper 4V must be closed
- jumper 5V_CHG_E must be open.
- USB_PWR/USB_CHG must be in position USB_PWR
- DCDC_E must be closed
- BTLT_E must be open

Power consumption in this mode is:

- Up to 70mA when during conversation.
- Around 20mA in normal mode (no conversation in progress).

Important: 4V_E, 4V and 5V_CHG_E jumpers have to be moved together.

2. Power from +12VDC with backup battery.

The module is powered with battery and allows battery charging. In this case:

- jumper BAT_E must be closed
- jumper 4V_E must be open
- jumper 4V must be open
- jumper 5V_CHG_E must be closed
- USB_PWR/USB_CHG must be in position USB_CHG
- DCDC_E must be closed
- BTLD_E must be open

- Power consumption in this mode:

Depends on live of the battery and vary from 270mA to 330mA (related to external power supply). If we supply the module only via the battery, without external power supply, the current through the battery is between 12mA and 18mA when GSM is connected to the network (stat led blinks with frequency $\sim 0.25\text{Hz}$) if there is no conversation in progress, and between 60mA to 180mA during conversation.

CONNECTOR DESCRIPTIONS

UEXT

Pin #	Signal Name
1	NC
2	GND
3	RXD
4	TXD
5	RTS
6	CTS
7	DTR
8	CHG_CTRL
9	RI
10	PWRKEY

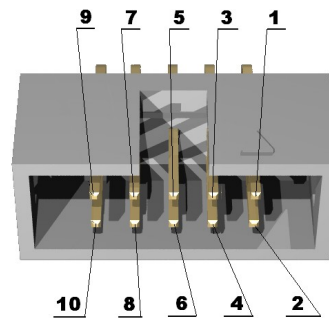

This connector allows connecting to other Olimex boards with UEXT connector.

SIM-CARD

Pin #	Signal Name
1	VSIM
2	SIMRST
3	SIMCLK
4	GND
5	NC
6	SIMDATA

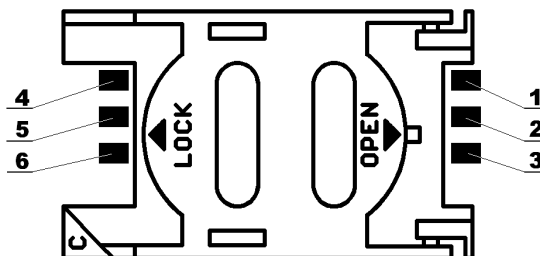

This is standard SIM card connector, to operate MOD-GSM-EDGE should have inserted valid SIM card for your operator network.

PWR-CON

Pin #	Signal Name
1	+12V
2	GND

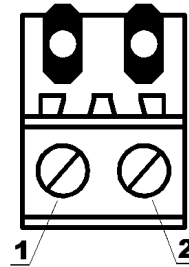

This connector is used to power the MOD-GSM-EDGE. External (+9-12VDC) power source have to be applied to this pins.

PWR_EXT

Pin #	Signal Name	Description
1	5V_IN	5V input for battery recharge
2	GND	Ground
3	VBAT	Output - for power supplying other devices from the GSM battery
4	PWR_IN	Optional input for external power supply
5	GPIO1	Doesn't work
6	AUXADC	Input for analog signal

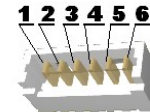

BAT

Pin #	Signal Name
1	GND
2	TEMP_BAT
3	Via jmp BAT_E to VBAT

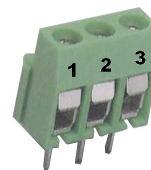

Note: The battery doesn't support TEMP_BAT.

USB

Pin #	Signal Name
1	VUSB_IN
2	USB_DN
3	USB_DP
4	NC
5	GND

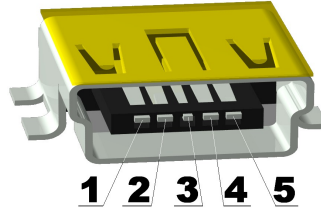

JUMPER DESCRIPTION

BAT_E



Connects 3.7V Li-ion battery to the GSM module. Default state is open to not drain the battery during stocking the modules.

Default state - open.

BTLD_E



When SIM700D firmware needs to be updated, the jumper should be closed before SIM700D powers up and the BOOTCTRL pin is pulled up to VBUS, and USB download mode is selected. Then SIM700D firmware could be updated through the USB PORT.

If USB download mode is used, there is a popup dialog window on the computer screen when SIM700D powers up first. Users need to install the USB driver manually. So the SIM700D couldn't provide the AUTORUN function.

Default state is open.

4V_E



This jumper is used when power the module without battery. When connected enable 4V to the DCDC output.

Default state - open.

4V



This jumper is used when powering the module without battery. When connected the jumper enables 4V to VBAT power pins of SIM700D module.

Default state - open.

5V_CHG_E



This jumper is used when the battery is present and allows battery charging. Connects the DCDC converter output (5V or 4V according 4V_E jumper state) to VCHG power pin of SIM700D module.

Default state closed

Important: 4V_E, 4V and 5V_CHG_E jumpers have to be moved together.

Do not plug in external +12V if BAT_E jumper is open!

DCDC_E



Enable DCDC. Connect DCDC output (5V or 4V according 4V_E jumper state) to the module.

Default state closed

Download



When the jumper is closed SIM700D firmware upgrade is allowed.

Default state - open

MTX/DTX



The MainTX/DebugTX defines whether Main TX terminal or Debug TX terminal of SIM700D module is connected to FT232RL virtual com port driver.

Default state is DTX

MRX/DRX



The MainRX/DebugRX define whether Main RX terminal or Debug RX terminal of SIM700D module is connected to FT232RL virtual com port driver.

Default state is DRX

AGND_E



Enable board analog ground.

Default state is closed

USB_PWR_E



Enable USB +5 V power supply.

Default state is closed

INPUT/OUTPUT

PWRKEY button - turns on the MOD-GSM-EDGE module. You can turn on the SIM700D by driving the PWRKEY to a low level voltage for period time from 500mS to 1S

Status LED (red) with name **STAT** - indicates the state of SIM700D module.

STAT is off state - SIM700D is not running

64ms On/ 800ms Off - SIM700D does not find the network

64ms On/ 3000ms Off - SIM700D find the network

64ms On/ 300ms Off - GPRS communication

MECHANICAL DIMENSIONS

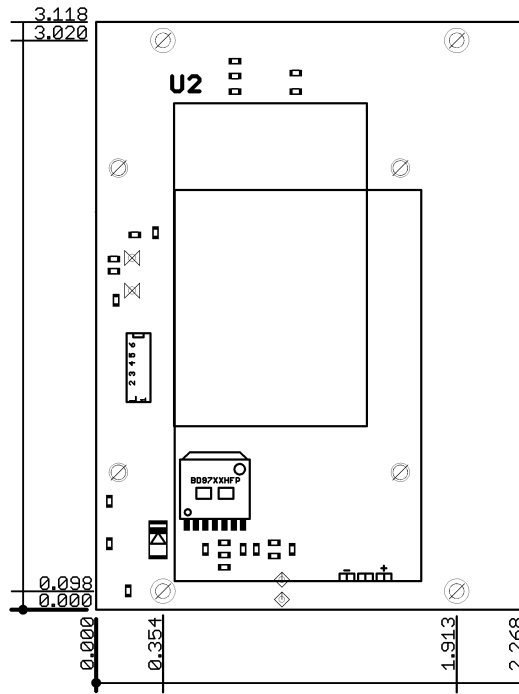

All measures are in inches.

AVAILABLE DEMO SOFTWARE

- [EW-ARM Demo code for MOD-GSM and MOD-GSM-EDGE \(high speed\) GSM modules](#) connected to STM32-LCD board by Olimex.

ORDER CODE

MOD-GSM-EDGE assembled and tested.

How to order?

You can order to us directly or by any of our distributors.

Check our web www.olimex.com/dev for more info.



All boards produced by Olimex are ROHS compliant

Revision history:

Board's revision: REV. B - created July 2010

Manual's revision: REV. Initial - created March 2011

Disclaimer:

© 2011 Olimex Ltd. All rights reserved. Olimex®, logo and combinations thereof, are registered trademarks of Olimex Ltd. Other terms and product names may be trademarks of others.

The information in this document is provided in connection with Olimex products. No license, express or implied or otherwise, to any intellectual property right is granted by this document or in connection with the sale of Olimex products.

Neither the whole nor any part of the information contained in or the product described in this document may be adapted or reproduced in any material form except with the prior written permission of the copyright holder.

The product described in this document is subject to continuous development and improvements. All particulars of the product and its use contained in this document are given by OLIMEX in good faith. However all warranties implied or expressed including but not limited to implied warranties of merchantability or fitness for purpose are excluded.

This document is intended only to assist the reader in the use of the product. OLIMEX Ltd. shall not be liable for any loss or damage arising from the use of any information in this document or any error or omission in such information or any incorrect use of the product.