



MSL1

* Pb Free Part

Customer Name	Standard specification	TAIYO YUDEN Mobile Technology Co.,Ltd.	
System	PCS-Tx (100/50 ohm,)	Date	March 31, 2010
Part Number	FAR-F6KB-1G8800-B4GS	Version 2.1b	

Table 1-1 Electrical Specification

Passband:1850.5 ~ 1909.5 MHz						
Item	Condition	Specification			Unit	Remarks
		Min.	Typ.	Max.		
Insertion Loss	1850.5~1909.5 MHz	-	2.3	3.0	dB	Ta=+25+/-2°C
		-	-	3.7		
Ripple	1850.5~1909.5 MHz	-	0.8	2.4	dB	
Absolute attenuation	DC~1770 MHz	25	37	-	dB	
	1770~1830 MHz	10	22	-	dB	
	1930.5~1989.5 MHz	25	28	-	dB	Ta=+25+/-2°C
		22	-	-	dB	
	1989.5~2400 MHz	25	32	-	dB	
	2400~3000 MHz	30	38	-	dB	
3000~6000 MHz	35	40	-	dB		
VSWR (Input)	1850.5~1909.5 MHz	-	1.9	2.3	-	
VSWR (Output)	1850.5~1909.5MHz	-	1.8	2.3	-	
Amplitude Balance S21 / S31	1850.5~1909.5 MHz	-1.7	-0.9/+1.2	+1.7	dB	
Phase Balance (Φ S21- Φ S31)-180	1850.5~1909.5 MHz	-12	-2/+3	+12	deg.	
Input Impedance	Unbalanced	50			Ohm	
Output Impedance	Balance	100//22nH			Ohm	
Operating Temperature		-30 ~ +85			°C	
Device size		1.4typ.x1.0typ.x0.5max.			mm	

TAIYO YUDEN



MSL1

* Pb Free Part

Customer Name	Standard specification	TAIYO YUDEN Mobile Technology Co.,Ltd.	
System	PCS-Tx (100/50 ohm,)	Date	March 31, 2010
Part Number	FAR-F6KB-1G8800-B4GS	Version 2.1b	

Dimensions

Device size: 1.4typ. x 1.0typ. x 0.5max

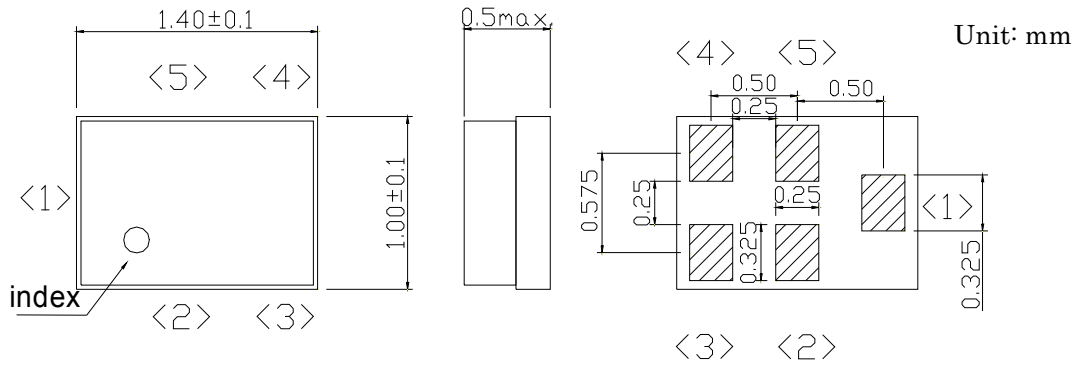

Pin Configuration

Pin No.	Symbol	Function
1	OUT	Unbalanced pin
2	GND	Ground
3	IN	Balanced pin
4	IN	Balanced pin
5	GND	Ground

Evaluation Circuit

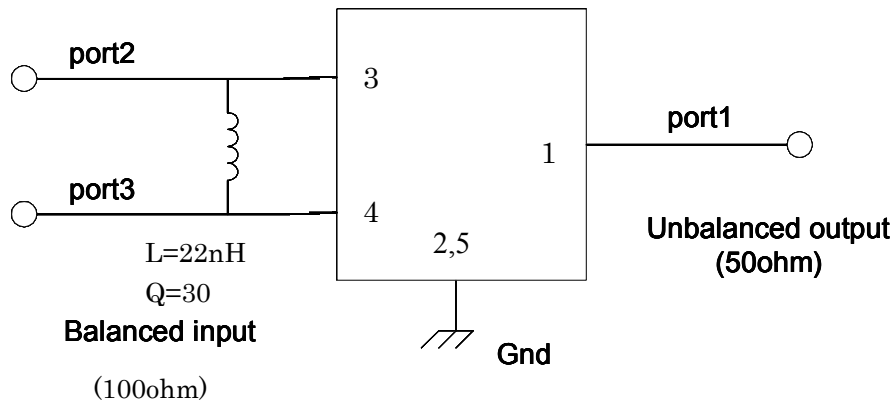

TAIYO YUDEN



MSL1

* Pb Free Part

Customer Name	Standard specification	TAIYO YUDEN Mobile Technology Co.,Ltd.	
System	PCS-Tx (100/50 ohm,)	Date	March 31, 2010
Part Number	FAR-F6KB-1G8800-B4GS	Version 2.1b	

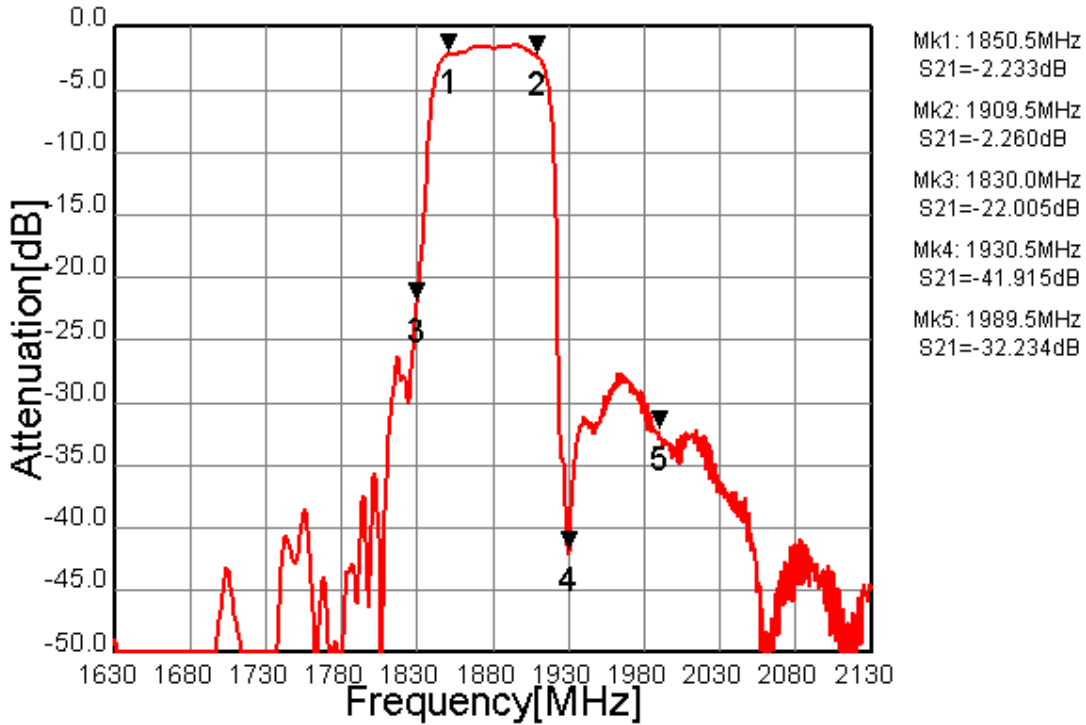

Fig.1-1 Pass-band-Characteristics

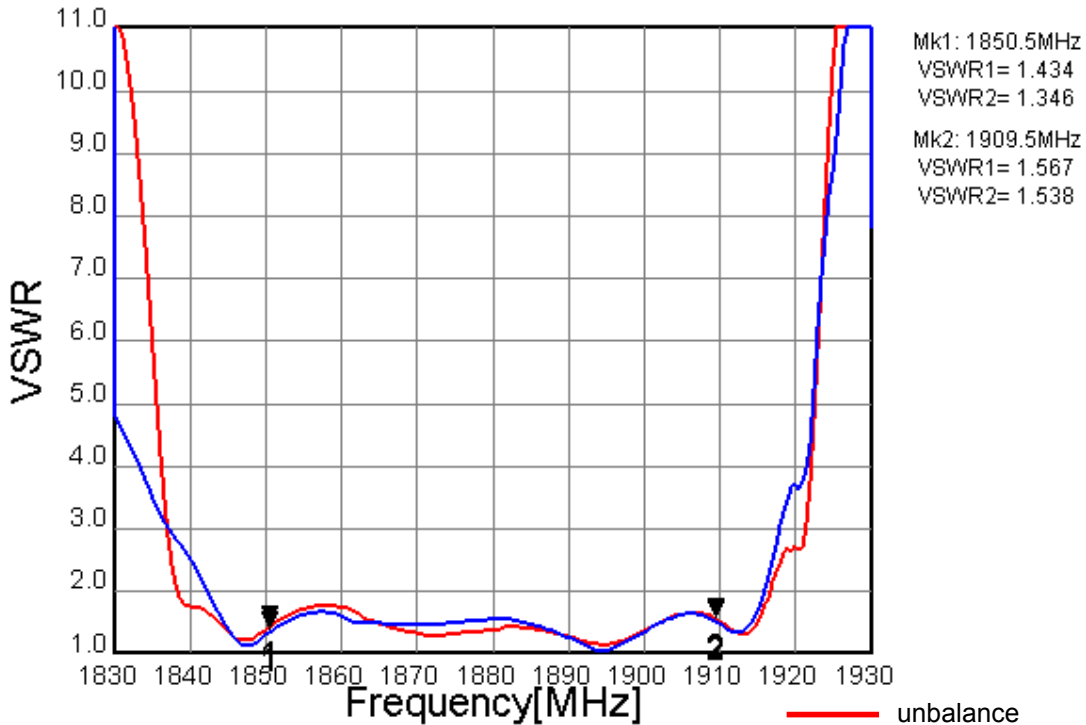

Fig.1-2 VSWR

TAIYO YUDEN



MSL1

* Pb Free Part

Customer Name	Standard specification	TAIYO YUDEN Mobile Technology Co.,Ltd.	
System	PCS-Tx (100/50 ohm,)	Date	March 31, 2010
Part Number	FAR-F6KB-1G8800-B4GS	Version 2.1b	

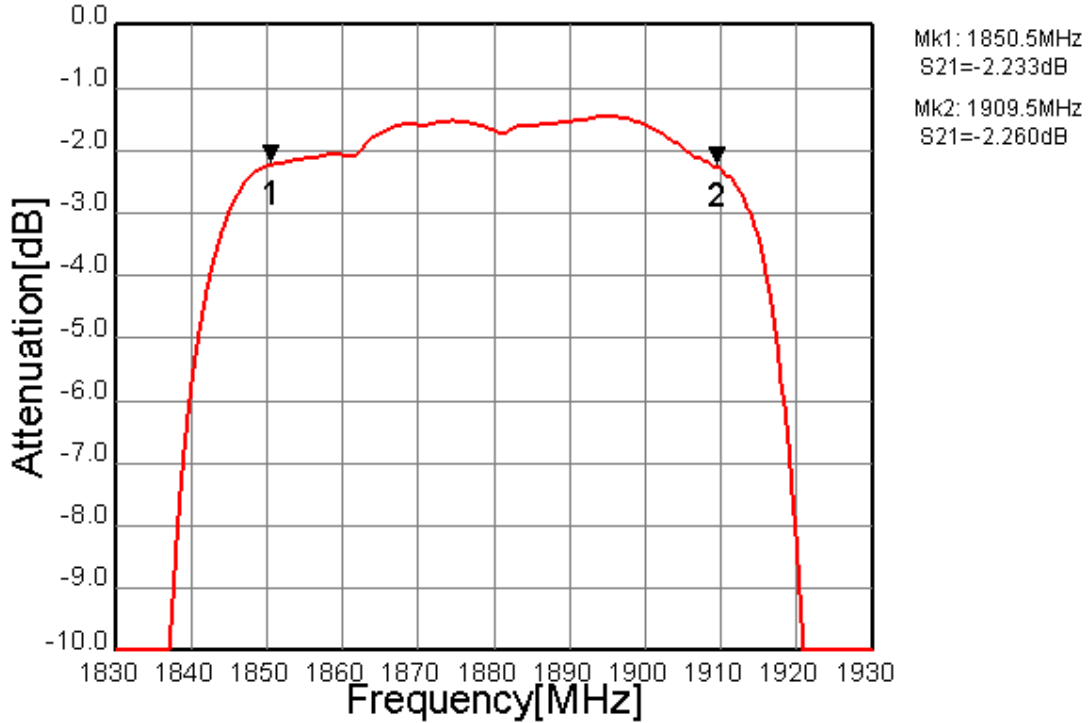

Fig.1-3 In-band Characteristics

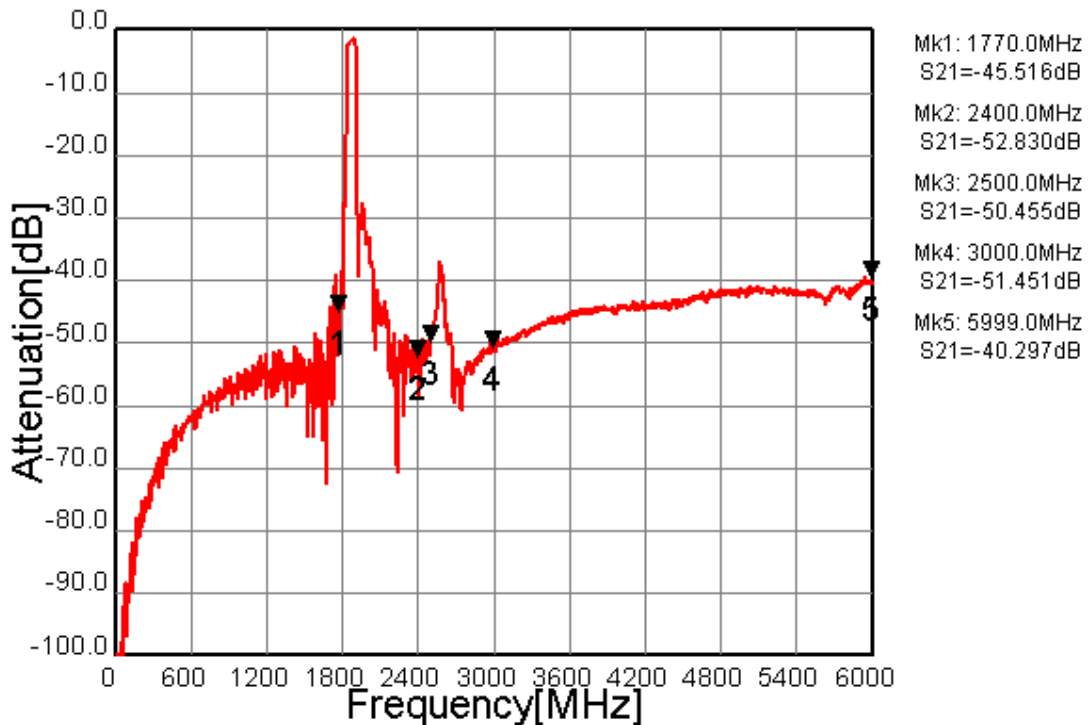

Fig.1-4 Wide-band Characteristics

TAIYO YUDEN



MSL1

* Pb Free Part

Customer Name	Standard specification	TAIYO YUDEN Mobile Technology Co.,Ltd.	
System	PCS-Tx (100/50 ohm,)	Date	March 31, 2010
Part Number	FAR-F6KB-1G8800-B4GS	Version 2.1b	

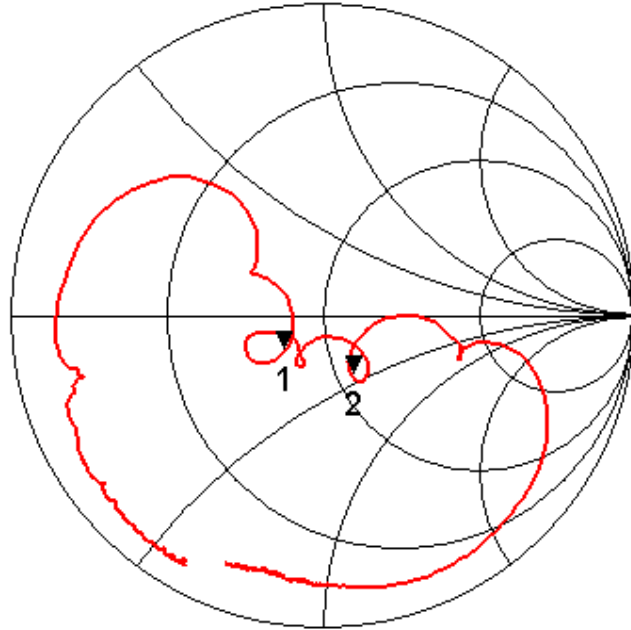

Mk1: 1850.5
 $S_{11} = 0.748 - j 0.186$
 Mk2: 1909.5
 $S_{11} = 1.112 - j 0.464$

v

Fig.1-5 Output Impedance (unbalance)

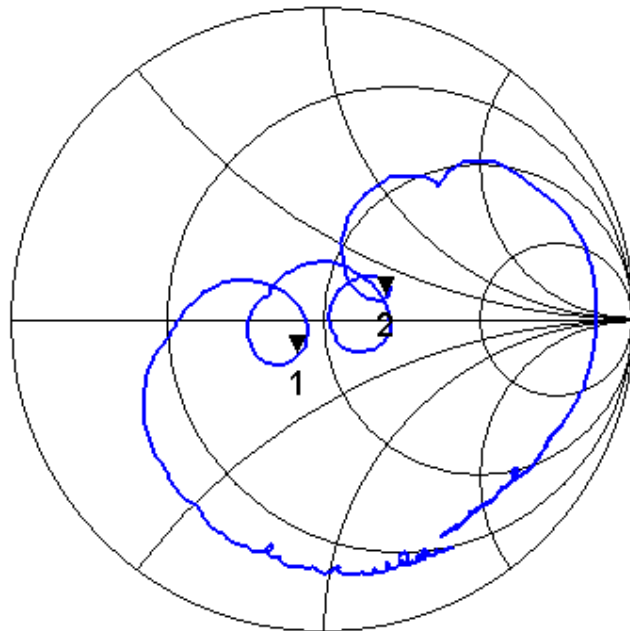

Mk1: 1850.5
 $S_{22} = 0.820 - j 0.201$
 Mk2: 1909.5
 $S_{22} = 1.476 + j 0.227$

Fig.1-6 Input Impedance (balance)

TAIYO YUDEN



MSL1

* Pb Free Part

Customer Name	Standard specification	TAIYO YUDEN Mobile Technology Co.,Ltd.	
System	PCS-Tx (100/50 ohm,)	Date	March 31, 2010
Part Number	FAR-F6KB-1G8800-B4GS	Version 2.1b	

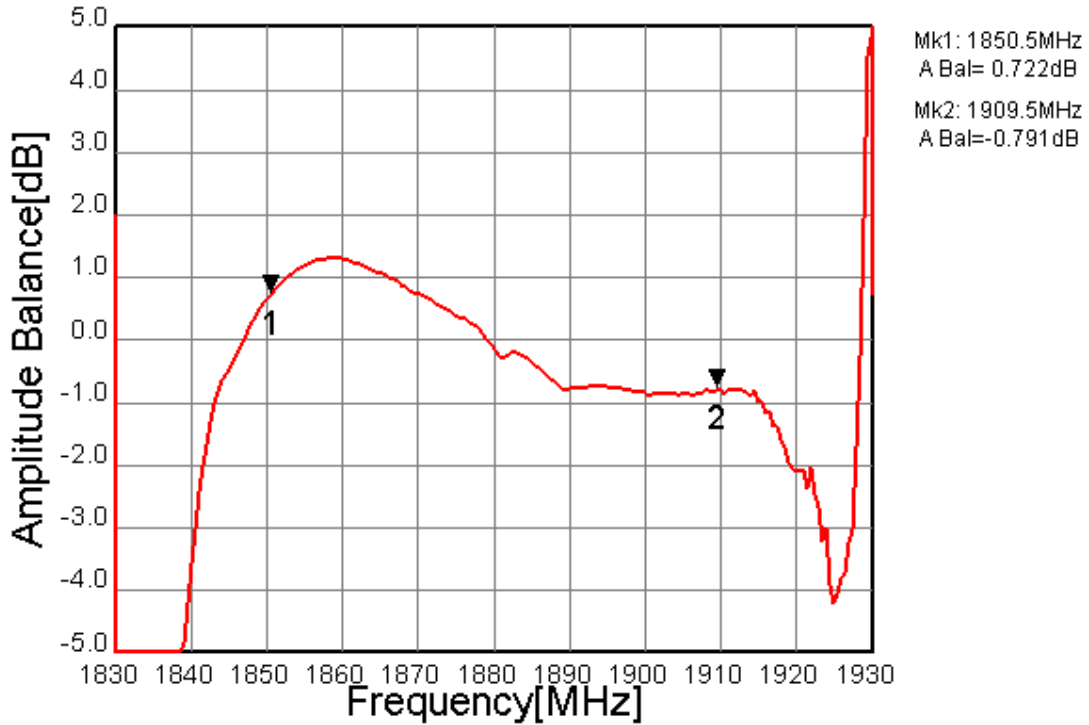

Fig.1-7 Amplitude Balance

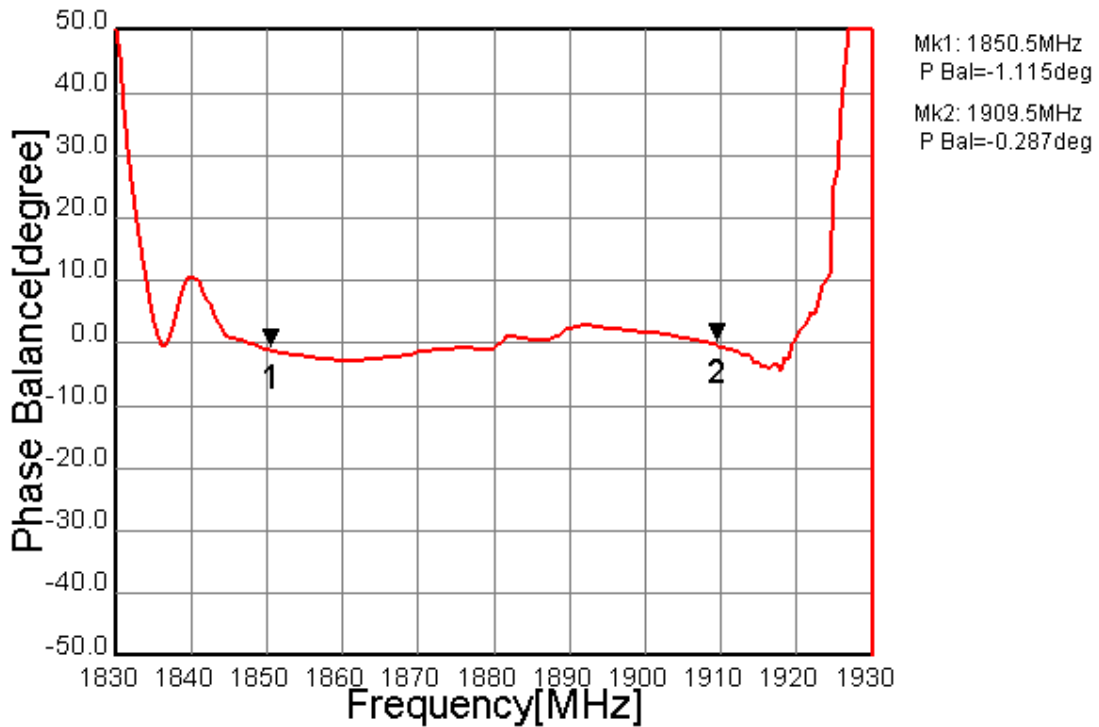

Fig.1-8 Phase Balance

TAIYO YUDEN