

Interactive Catalog Supplements Catalog PDFs

If you need detailed product information, or help choosing the right product for your application, see our [Interactive Catalog](#). Use the [Interactive Catalog](#) to access the most complete and up-to-date information available.

The [Interactive Catalog](#) provides an extensive collection of product specifications, application data, and technical literature that can be searched based on criteria you select.

This PDF catalog information was published in November 2000.



Sensing and Control
[Interactive Catalog...](#)

**Click this icon to try
the Interactive Catalog.**

Sensing and Control
Honeywell Inc.
11 West Spring Street
Freeport, IL 61032

www.honeywell.com/sensing

Manual Switches

Toggle Switches

TL Series

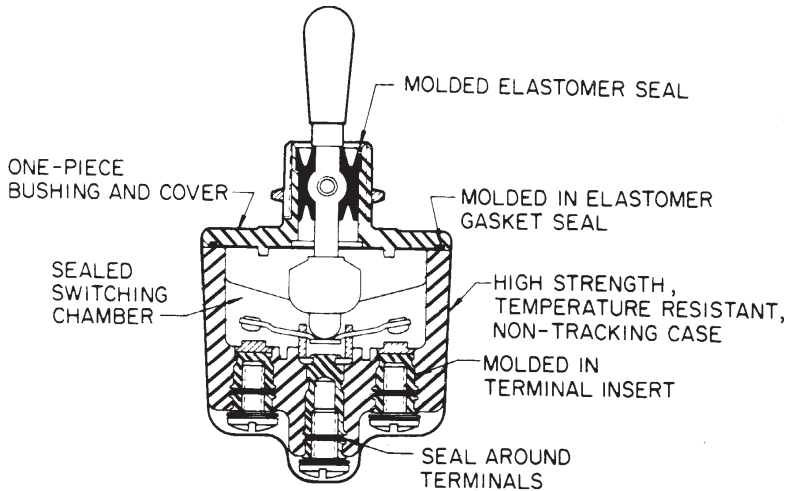
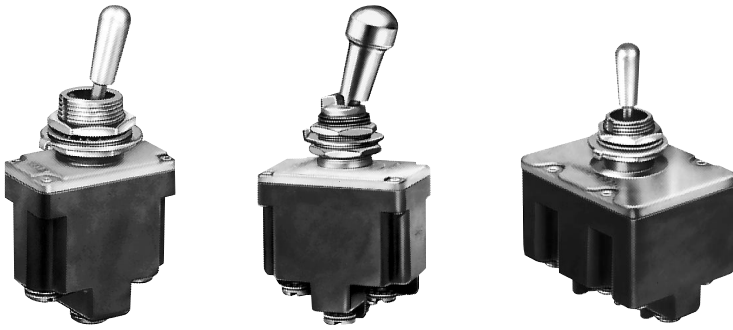

FEATURES

- Qualified to MIL-S-3950
- Environment-proof sealing
- 1, 2, and 4 pole circuitry.
- Standard and pull to unlock levers.
- 2 and 3 position, maintained, and momentary toggle action.
- Temperature range: -85°F to +160°F (-65°C to +71°C).
- UL recognized, CSA certified.
- CE approved

CONSTRUCTION

TL's have high strength, temperature resistant, non-tracking case material and silver cadmium oxide contacts.

ACTUATOR OPTIONS

Standard toggle lever operates on a direct action spring loaded toggle mechanism to provide excellent tactile feedback in both the momentary and maintained toggle positions. The toggle lever is approximately .68 in. (16 mm) long and has a non-glare matte nickel plated finish.

Pull-to-unlock toggle levers prevent accidental toggle movement. The knobbed toggle lever must be pulled out approximately .09 in. (2,3 mm) to change positions. Thirteen different locking configurations are available. This lever style also has a non-glare matte nickel finish.

Colored tab levers (not shown) can also be furnished. They have the same appearance as the tab lever shown in the TW photo on page 119. Call the 800 number.

ELECTRICAL RATINGS

(In amperes)

Elec. Rating Code	28 VDC			115 VDC	250 VDC	115 VAC 60 & 400 Hz			230 VAC
	Ind.	Res.	Lamp	Res.	Res.	Ind.	Res.	Lamp	Res.
1	15	20	5	0.75	0.5	10	15	3	6
2	10	15	4	0.75	0.5	7	15	2	6
3	15	20	7	0.75	0.5	15	15	4	6
4	10	18	5	0.75	0.5	8	11	2	6
5	12	20	5	0.75	0.5	15	15	4	6
6	10	18	4	0.75	0.5	8	11	2	6

UL/CSA Rating Code	Electrical Rating
L192	10 amps-125, 250, 277 VAC; ¼ Hp-125 VAC; ½ Hp-250, 277 VAC 3 amps-125 VAC "L"
L191	15 amps-125, 250, 277 VAC; ½ Hp-125 VAC; 1 Hp-250, 277 VAC 5 amps-120 VAC "L"

Application Note: Honeywell MICRO SWITCH does *not* recommend the use of silver cadmium oxide switch contacts in non-arcing loads. Non-arcing loads are generally loads less than 12 volts and/or 0.5 amp. TL switches use silver cadmium oxide contacts. For other options, contact the MICRO SWITCH Application Center at 1-800-537-6945.

Manual Switches

Toggle Switches

TERMINAL CIRCUIT IDENTIFICATION

Terminal identifications are referred to in the order guides to indicate which circuits are made in each toggle position (i.e., 1-2 refers to circuit closure through terminals 1 and 2).

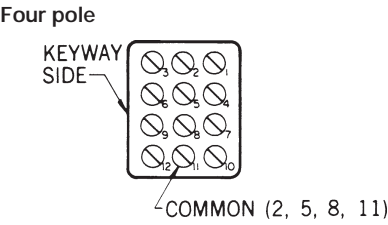
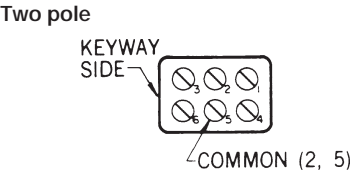
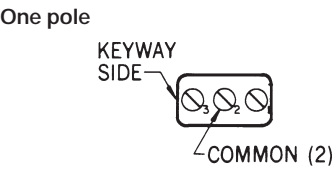

TERMINALS

In addition to the screw terminal switches listed in the order guides, IWTS Integrated Wire Termination System versions (covered in MICRO SWITCH Catalog 80) and solder turret terminals are available. Contact the 800 number.

SPECIAL CIRCUITRIES

Catalog listings with -10, -50, and -70 suffix numbers shown in the order guides have special "On-On-On" circuits, as illustrated. TLs with -12 suffix are the same as -50 except the keyway position is maintained, and in the center position circuits

2-3 and 4-5 are made; -72 is the same as -50 except that the opposite keyway position is momentary, and in the center position circuits 2-3 and 4-5 are made.

-10 CIRCUITRY

No. of Poles	Keyway Side Maint. Position	Center Maint. Position	Opposite Keyway Maint. Position
2			
4			

-50 CIRCUITRY

No. of Poles	Keyway Side Mom. Position	Center Maint. Position	Opposite Keyway Maint. Position
2			
4			

-70 CIRCUITRY

No. of Poles	Keyway Side Mom. Position	Center Maint. Position	Opposite Keyway Mom. Position
2			
4			

ACCESSORIES

Colored lever sleeves, decorative mounting hardware, and panel seal accessories are shown on page 135.



Toggle/Rockers

Manual Switches

Toggle Switches

TL Series

2-POSITION ORDER GUIDE













	No. of Poles	Circuit(s) Made With Toggle At:		Electrical Rating Code	UL/CSA Rating Code	Standard Toggle		Pull-to-Unlock Toggle	
		Keyway Position	Opposite Keyway			Catalog Listing	Military Number	Add Suffix to Standard Toggle Listing	Military Number **
	1	OFF OFF* 1-2* 1-2 1-2*	2-3 2-3 OFF 2-3 2-3	1 2 2 1 2	L191 L192 L192 L191 L192	1TL1-2 1TL1-4 1TL1-6 1TL1-3 1TL1-8	MS24523-22 MS24523-29 MS24523-30 MS24523-23 MS24523-26	D, F, G F F D, F, G F	MS24658-22 MS24658-29 MS24658-30 MS24658-23 MS24658-26
	2	OFF OFF* 1-2, 4-5* 1-2, 4-5 1-2, 4-5*	2-3, 5-6 2-3, 5-6 OFF 2-3, 5-6 2-3, 5-6	3 4 4 3 4	L191 L192 L192 L191 L192	2TL1-2 2TL1-4 2TL1-6 2TL1-3 2TL1-8	MS24524-22 MS24524-29 MS24524-30 MS24524-23 MS24524-26	D, F, G F F D, F, G F	MS24659-22 MS24659-29 MS24659-30 MS24659-23 MS24659-26
	4	OFF OFF* 1-2, 4-5 7-8, 10-11* 1-2, 4-5 7-8, 10-11 1-2, 4-5* 7-8, 10-11	2-3, 5-6 8-9, 11-12 2-3, 5-6 8-9, 11-12 OFF 2-3, 5-6 8-9, 11-12 2-3, 5-6 8-9, 11-12 2-3, 5-6 8-9, 11-12	5 6 6 5 6	L191 L192 L192 L191 L192	4TL1-2 4TL1-4 4TL1-6 4TL1-3 4TL1-8	MS24525-22 MS24525-29 MS24525-30 MS24525-23 MS24525-26	D, F, G F F D, F, G F	MS24660-22 MS24660-29 MS24660-30 MS24660-23 MS24660-26

* These positions only are momentary. All others are maintained.
 ** Also add the appropriate suffix letter to the Military number.

PULL-TO-UNLOCK OPTION

When ordering pull-to-unlock toggle listings, add the suffix letter shown in the chart below to the standard toggle listing and the MS number. For example, to order a 1TL1-1 pull-to-unlock toggle switch with the lever locked in the center position, add the letter E; i.e., 1TL1-1E, MS-24658-21E.

LOCKING CONFIGURATIONS



 Locked In Three Positions	 Locked In Center and Extreme Position (Keyway Side)	 Locked Out Of Center Position	 Locked In Center Position	 Locked In Extreme Position (Opposite Keyway)	 Locked In Extreme Position (Keyway Side)	 Locked Out Of Center And Extreme Position (Keyway Side)
 Locked Out Of Center And Extreme Position (Opposite Keyway)	 Locked In Center And Extreme Position (Opposite Keyway)	 Locked Out Of Extreme Position (Keyway Side)	 Locked Out Of And Into Extreme Position (Opposite Keyway)	 Locked Out Of Extreme Position (Opposite Keyway)	 Locked Out Of And Into Extreme Position (Keyway Side)	

Manual Switches

Toggle Switches

TL Series

3-POSITION ORDER GUIDE

	No. of Poles	Circuit(s) Made With Toggle At:			Elec. Rating Code	UL/CSA Rating Code	Standard Toggle		Pull-to-Unlock Toggle	
		Keyway Position	Center Position	Opposite Keyway			Catalog Listing	Military Number***	Add Suffix to Standard Toggle Listing	Military Number***
	1	1-2	OFF	2-3	1	L191	1TL1-1	MS24523-21	ALL TYPES	MS24658-21
		1-2*	OFF	2-3	2	L192	1TL1-5	MS24523-31	E, F, K, L, M, N	MS24658-31
		1-2*	OFF	2-3*	2	L192	1TL1-7	MS24523-27	E, L, N	MS24658-27
		None**	OFF	2-3	1	L191	1TL1-21	MS24523-24	E, F, K, M	MS24658-24
		None**	1-2	2-3	1	L192	1TL1-31	MS24523-33	E, F, K, M	MS24658-33
		None**	1-2	2-3*	2	L192	1TL1-51	MS24523-32	E	MS24658-32
		1-2*	OFF	None**	2	L192	1TL1-61	MS24523-28	E	MS24658-28
	2	1-2, 4-5	OFF	2-3, 5-6	3	L191	2TL1-1	MS24524-21	ALL TYPES	MS24659-21
		1-2, 4-5*	OFF	2-3, 5-6	4	L192	2TL1-5	MS24524-31	E, F, K, L, M, N	MS24659-31
		1-2, 4-5*	OFF	2-3, 5-6*	4	L192	2TL1-7	MS24524-27	E, L, N	MS24659-27
		None**	OFF	2-3, 5-6	3	L191	2TL1-21	MS24524-24	E, F, K, M	MS24659-24
		None**	1-2, 4-5	2-3, 5-6	3	L191	2TL1-31	MS24524-33	E, F, K, M	MS24659-33
		None**	1-2, 4-5	2-3, 5-6*	4	L192	2TL1-51	MS24524-32	E	MS24659-32
		1-2, 4-5*	OFF	None**	4	L192	2TL1-61	MS24524-28	E	MS24659-28
		1-2, 4-5	1-2, 5-6	2-3, 5-6	3	L191	2TL1-10	MS27407-4	ALL TYPES	MS27408-4
		1-2, 4-5*	1-2, 5-6	2-3, 5-6	4	L192	2TL1-50	MS27407-5	E, F, K, L, M, N	MS27408-5
		1-2, 4-5*	1-2, 5-6	2-3, 5-6*	4	L192	2TL1-70	MS27407-6	E, L, N	MS27408-6
			4	1-2, 4-5 7-8, 10-11	OFF	2-3, 5-6 8-9, 11-12	5	L191	4TL1-1	MS24525-21
1-2, 4-5 7-8, 10-11*	OFF			2-3, 5-6 8-9, 11-12	6	L192	4TL1-5	MS24525-31	E, F, K, L, M, N	MS24660-31
1-2, 4-5 7-8, 10-11*	OFF			2-3, 5-6 8-9, 11-12*	6	L192	4TL1-7	MS24525-27	E, L, N	MS24660-27
None**	OFF			2-3, 5-6 8-9, 11-12	5	L191	4TL1-21	MS24525-24	E, F, K, M	MS24660-24
None**	1-2, 4-5 7-8, 10-11			2-3, 5-6 8-9, 11-12	5	L191	4TL1-31	MS24525-33	E, F, K, M	MS24660-33
None**	1-2, 4-5 7-8, 10-11			2-3, 5-6 8-9, 11-12*	6	L192	4TL1-51	MS24525-32	E	MS24660-32
1-2, 4-5 7-8, 10-11*	OFF			None**	6	L192	4TL1-61	MS24525-38	E	MS24660-28
1-2, 4-5 7-8, 10-11	2-3, 4-5			2-3, 5-6 8-9, 11-12	5	L191	4TL1-10	—	ALL TYPES	—
1-2, 4-5 7-8, 10-11*	2-3, 4-5 7-8, 11-12			2-3, 5-6 8-9, 11-12	6	L192	4TL1-50	MS27406-2	E, F, K, L, M, N	MS27409-2
1-2, 4-5 7-8, 10-11*	2-3, 4-5			2-3, 5-6 8-9, 11-12*	6	L192	4TL1-70	—	E, L, N	—
1-2, 4-5 7-8, 10-11	2-3, 4-5 7-8, 11-12			2-3, 5-6 8-9, 11-12	5	L191	4TL1-12	MS27406-1	ALL TYPES	MS27409-1
1-2, 4-5 7-8, 10-11*	2-3, 4-5 7-8, 11-12	2-3, 5-6 8-9, 11-12*	6	L192	4TL1-72	MS27406-3	E, L, N	MS27409-3		

* These positions only are momentary. All others are maintained.

** Toggle lever is blocked from these positions. Toggle becomes two position, with center being one extreme position.

*** Also add appropriate suffix letter to the Military Number.

SOLDER TURRET TERMINAL VERSION



HOW TO ORDER

11TL, 12TL, and 14TL type switches with solder turret terminals are qualified to MIL-S-3950. They have the same circuitry and electrical ratings as their 1TL, 2TL, and 4TL counterparts. For example, 11TL1-2 is the same as 1TL1-2, except it has solder turret terminals instead of screw terminals. The complete MS drawing numbers are shown in data sheet 204.

Circuitry	Type	Std. Lever	Lever Lock
One Pole	11TL	MS27734	MS27737
Two Pole	612TL	MS27735	MS27738
Four Pole	14TL	MS27736	MS27739

Toggle/Rockers

Manual Switches

Toggle Switches

TL Series

MOUNTING DIMENSIONS (For reference only)

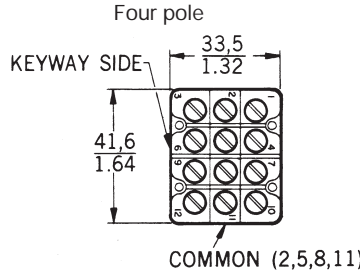
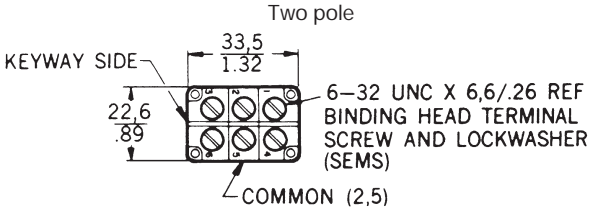
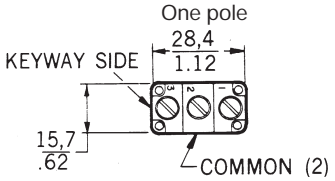
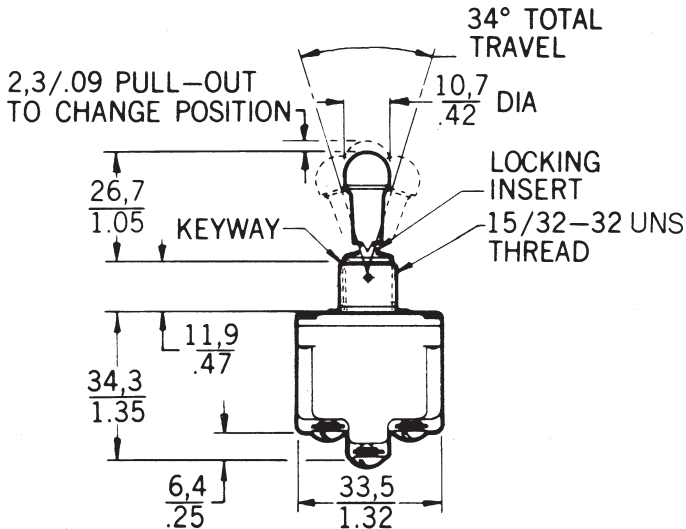
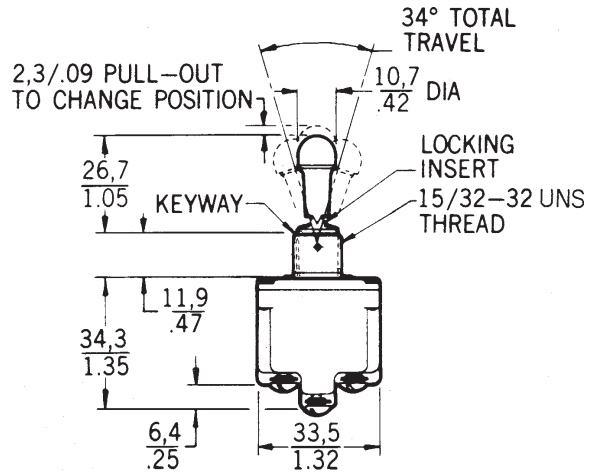

Note:
Terminal screws, and mounting hardware (locking ring, lockwasher, and two hexnuts) are furnished unassembled.

Key: $\frac{0,0}{0.00} = \text{mm}$
 $\frac{\quad}{\quad} = \text{inches}$

Panel cutout

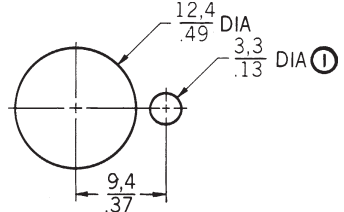

With locking ring

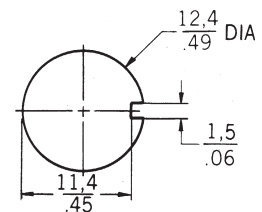

Without locking ring

Note:
Ⓢ 1,4/.06 MIN DEEP TO ACCOMMODATE LOCKING RING. 15PA87 PANEL SEAL REQUIRES BLIND HOLE TO INSURE SEAL INTEGRITY

Bushing mounting torque is 10-15 in./lbs.
Terminal screw mounting torque is 5 in./lbs. max.