

Note: All part numbers are RoHS Compliant.

Index—Eurostyle

One-Piece Board Mount (Cage Clamp)

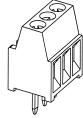

	Page No.	Page No.	Page No.
16-30 AWG	Straight		
2.54 mm Centerline	8	—	—
5.08 mm Centerline	8	—	—

Low Profile High Temperature and Standard

	Page No.	Page No.	Page No.
16-28 AWG	Straight		
3.5 mm Centerline	9	—	—
3.81 mm Centerline	9	—	—

Stacking with Interlock

	Straight	Rt.-Angle	
14-30 AWG			
3.50 mm Centerline	9	19	—
3.81 mm Centerline	10	19	—

Low Profile Stacking with Interlock

	Straight	Rt.-Angle	
16-30 AWG			
5.00 mm Centerline	11	20	—
5.08 mm Centerline	11	21	—
10.00 mm Centerline	16, 17	24	—
10.16 mm Centerline	18	25	—

Stacking with Interlock

	Straight	Rt.-Angle	Angled
12-30 AWG			
5.00 mm Centerline	12	20, 21, 28	26
5.08 mm Centerline	13, 14	21, 22	26
7.50 mm Centerline	14, 15	23	—
7.62 mm Centerline	15, 16	23	—
10.00 mm Centerline	16, 17	24	27
10.16 mm Centerline	18	25	27

High Current Stacking with Interlock

	Straight	Rt.-Angle	Angled
10-24 AWG			
6.35 mm Centerline	29	—	—
9.52 mm Centerline	29	—	30

Multi-Level Stacking with Interlock 1st and 2nd Level

16-30 AWG	
5.00 mm Centerline	32
5.08 mm Centerline	33

12-30 AWG	
5.00 mm Centerline	32
5.08 mm Centerline	33, 34

Multi-Level Stacking with Interlock 2nd and 3rd Level

16-30 AWG	
5.08 mm Centerline	34
12-30 AWG	
5.08 mm Centerline	35

Multi-Level Stacking with Interlock Three Levels

	Page No.
16-30 AWG	
5.00 mm Centerline	35
5.08 mm Centerline	36

12-30 AWG	
5.00 mm Centerline	36
5.08 mm Centerline	37

Multi-Level Stacking with Interlock 2nd Level

16-30 AWG	
5.00 mm Centerline	38
5.08 mm Centerline	39

12-30 AWG	
5.00 mm Centerline	38, 39
5.08 mm Centerline	40

Multi-Level Stacking with Interlock 3rd Level

16-30 AWG	
5.00 mm Centerline	41
10.00 mm Centerline	43

12-30 AWG	
5.00 mm Centerline	41
5.08 mm Centerline	42

One-Piece Board Mount (Wire Protector Version)

Straight Stacking with Interlock 14-22 AWG

5.00 mm Centerline	95
--------------------	----

Low Profile Straight Stacking with Interlock (LT)

14-22 AWG	
5.00 mm Centerline	95, 97

Straight Stacking with Interlock (LT)

18-26 AWG	
3.50 mm Centerline	96
14-22 AWG	
5.00 mm Centerline	98

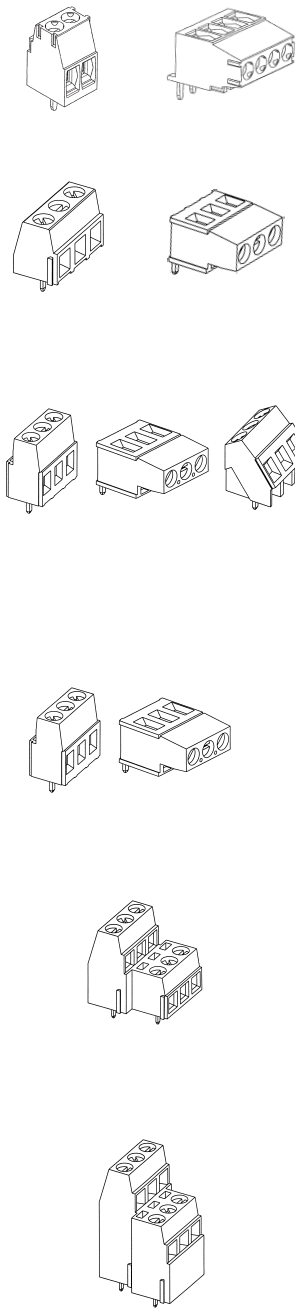

Note: All part numbers are RoHS Compliant.

Index—Eurostyle

One-Piece Board Mount (Wire Protector Version)

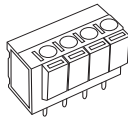
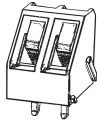

Two-Piece

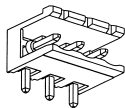
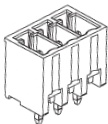
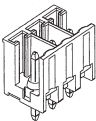
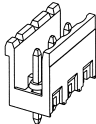

45° Wire Inlet with Interlock (LT)

14-22 AWG	Page No.
5.00 mm Centerline	99
5.08 mm Centerline	99

SMT with Wire Trap

2.5 mm Centerline	101
-------------------	-----

Screwless

14-22 AWG	
5.00 mm Centerline	103-105
5.08 mm Centerline	103-105

Straight Open End Headers

5.00 mm Centerline	51
5.08 mm Centerline	52
7.50 mm Centerline	53
7.62 mm Centerline	54
10.00 mm Centerline	55
10.16 mm Centerline	56

Straight Open End Headers with Interlock

3.50 mm Centerline	49
3.81 mm Centerline	50
5.00 mm Centerline	57
5.08 mm Centerline	57

Straight Closed End Headers

3.50 mm Centerline	49
3.81 mm Centerline	50
5.00 mm Centerline	51
5.08 mm Centerline	52
7.50 mm Centerline	53
7.62 mm Centerline	54
10.00 mm Centerline	55
10.16 mm Centerline	56

Right-Angle Open End Stacking Headers

5.00 mm Centerline	59
5.08 mm Centerline	61
7.50 mm Centerline	62
7.62 mm Centerline	63
10.00 mm Centerline	64
10.16 mm Centerline	65

Two-Piece (Continued)

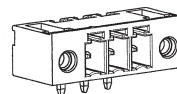
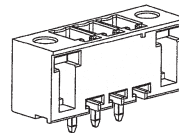
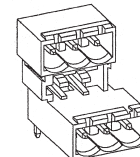
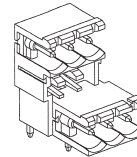
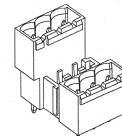
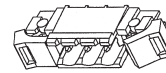
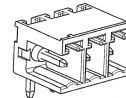
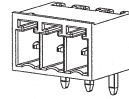

Right-Angle Closed End Headers

	Page No.
3.50 mm Centerline	58
3.81 mm Centerline	58
5.00 mm Centerline	59
5.08 mm Centerline	61
7.50 mm Centerline	62
7.62 mm Centerline	63
10.00 mm Centerline	64
10.16 mm Centerline	65

Right-Angle Open End Headers with Interlock

5.00 mm Centerline	66
5.08 mm Centerline	66

Right-Angle Closed End Headers with Ejectors

5.08 mm Centerline	67
--------------------	----

Straight Closed End Double-Row Headers with Interlock

5.00 mm Centerline	68
5.08 mm Centerline	68
10.00 mm Centerline	69
10.16 mm Centerline	69

Right-Angle Open End Double-Row Headers with Interlock

5.00 mm Centerline	70
5.08 mm Centerline	70

Right-Angle Closed End Double-Row Headers with Interlock

5.00 mm Centerline	71
5.08 mm Centerline	71
10.00 mm Centerline	72
10.16 mm Centerline	72

Straight Headers with Threaded Flange

3.50 mm Centerline	45
3.81 mm Centerline	45
5.08 mm Centerline	46

Right-Angle Closed End Headers with Threaded Flange

3.50 mm Centerline	47
3.81 mm Centerline	47
5.00 mm Centerline	48
5.08 mm Centerline	48

Note: All part numbers are RoHS Compliant.

Index—Eurostyle

Two-Piece (Continued)

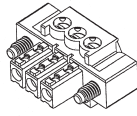

Right-Angle Plugs with Screw Flange	Page No.
14-30 AWG	
3.50 mm Centerline	73
3.81 mm Centerline	73
12-30 AWG	
5.00 mm Centerline	74
5.08 mm Centerline	74

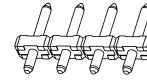

Unshrouded Pin Headers	Page No.
5.0 mm Centerline	85
10.0 mm Centerline	85

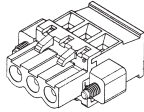

Straight Plugs with Screw Flange, Left- and Right-Hand Versions	Page No.
12-30 AWG	
5.08 mm Centerline	75

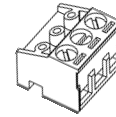

Special 90°/180° and 90°/270° Plug Connectors	Page No.
14-30 AWG	
5.0 mm Centerline	86, 87
10.0 mm Centerline	88

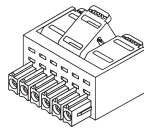

PIVOT BLOCK Plugs (IDC)	Page No.
22-24 AWG	
3.5 mm Centerline	102

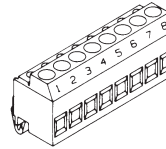

Flush-Mount Plug-In Connectors with Cage Clamp	Page No.
12-30 AWG	
5.00 mm Centerline	89
5.08 mm Centerline	91

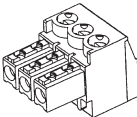

Right-Angle Plugs	Page No.
14-30 AWG	
3.50 mm Centerline	76
3.81 mm Centerline	76

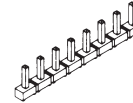

Unshrouded Pin Headers	Page No.
5.00 mm Centerline	90
5.08 mm Centerline	92

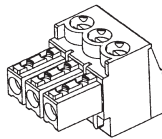

Right-Angle Plugs with Interlock	Page No.
14-30 AWG	
3.81 mm Centerline	80

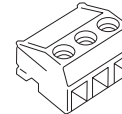

Flush Mount Plug	Page No.
14-22 AWG	
5.00 mm Centerline	100

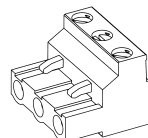

Right-Angle Plugs with Retention Latch	Page No.
12-30 AWG	
5.00 mm Centerline	77
5.08 mm Centerline	77
7.50 mm Centerline	78
7.62 mm Centerline	78
10.00 mm Centerline	79
10.16 mm Centerline	79

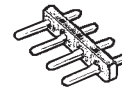

Straight Unshrouded Pin Header	Page No.
5.00 mm Centerline	100

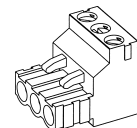

Right-Angle Stacking Plugs with Retention Latch and Interlock	Page No.
12-30 AWG	
5.00 mm Centerline	81
5.08 mm Centerline	81

Accessories

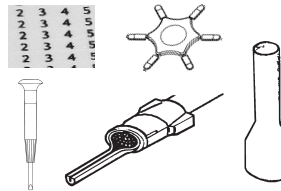

Labeling	106
Polarization Keys	107
Screwdrivers	107
Wire Pins	108
Wire Ferrules	109, 110

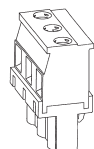

Straight Plugs with Retention Latch, Left- and Right-Hand Versions	Page No.
12-30 AWG	
5.00 mm Centerline	82
5.08 mm Centerline	83
7.50 mm Centerline	84
7.62 mm Centerline	84
10.00 mm Centerline	84
10.16 mm Centerline	84

Stacking Screw Clamp Connectors

Product Facts

n Certified by the VDE Testing
and Certification Institute
VDE File No. 6917
(Two-Piece Version)
VDE File No. 6920
(One-Piece Version)



n Recognized under
the Component Program of
Underwriters
Laboratories Inc.,
File No. E60677



n Certified by Canadian
Standards
Association,
File No. 703157



n Produced under Quality
Management System
certified to ISO 9001

Technical Documents

Product Specification:

108-20166 Terminal Block Connectors,
Stacking PC Board Mount

Application Specification:

114-20079 Terminal Block
Stacking Connectors

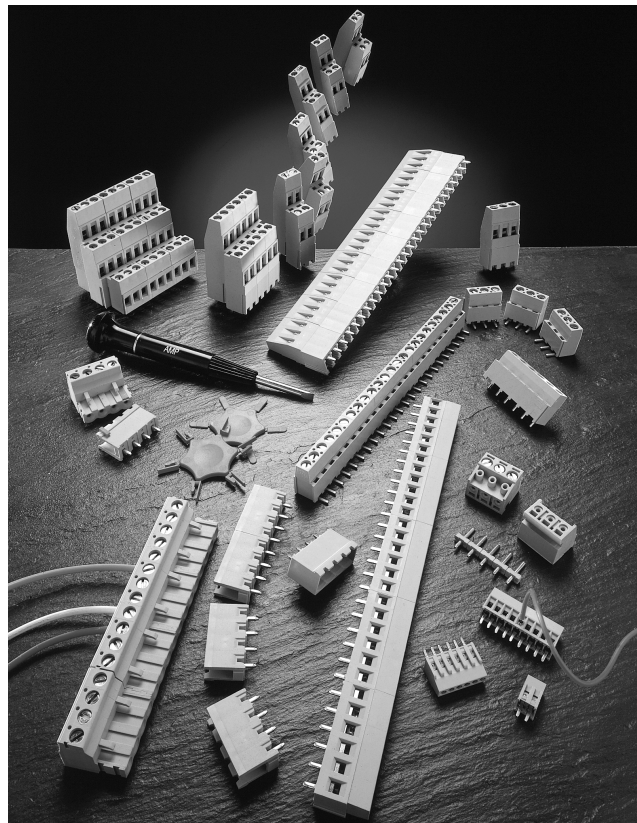

Terminal Block connectors feature the special rising cage clamp design (see illustration on page 7). The modular design of Terminal Block connectors consists of one-piece board mount terminal blocks and plug connectors with mating straight and right-angle shrouded headers. A special version – which can be mated either 90° or 180° – completes the product line. Terminal Block connectors offer several advantages:

- n IR Reflow compatible
- n Terminal Block connectors have a rising cage clamp which promotes numerous reliable connections and disconnections at field installations
- n All blocks are supplied with open screws which shortens the time for connection
- n The double captive screw system guards against lost screws

- n All metal parts are non-magnetic
- n The housing material used is halogen free Polyamide 6.6 according to UL 94V-0 (self-extinguishing); operating temperature -40°C to +105°C
- n The housing funnel entry design enables an easier product application
- n The open bottom design facilitates the PCB washing and reduces trapping of soldering fumes and dirt, with better insulation
- n Available on the board mount connectors is test probe access to determine if an electrical connection has been made
- n Contacts are post tinned with nickel underplate which allows the product to be used in specially corrosive environments

Board mount connectors, as well as pc board plugs and headers, are stackable end-

to-end without loss of centerline spacing.

Ease of assembly is facilitated by built-in interlocks on the housings. Pre-assembled products can be delivered upon request. Adhesive labels are available to number the cavities. Customer specific labeling is also available upon request.

Terminal Block connectors are interchangeable with most existing products and pc board footprint is fully compatible with existing Industry Standards.

Note: All part numbers are RoHS Compliant.

Terminal Block Board Mount Connectors

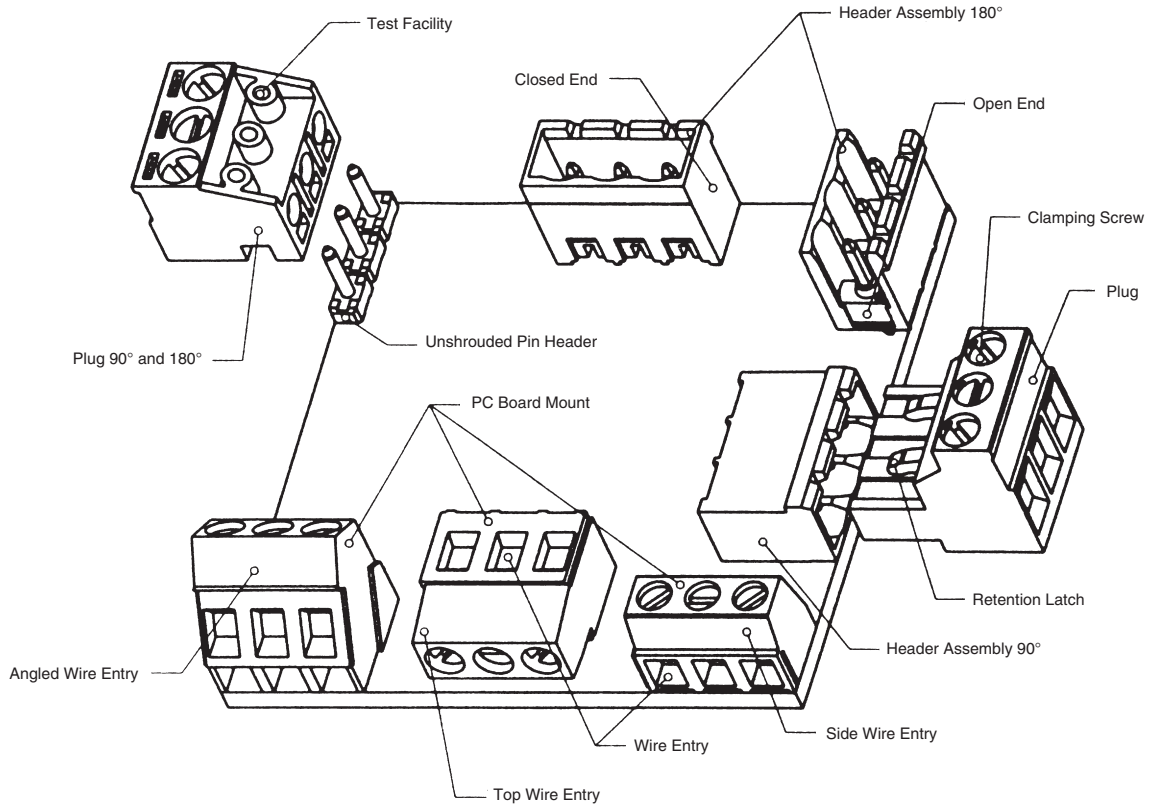

Eurostyle
1

Rising Cage Clamp Design

Cross Section One-Piece Connector

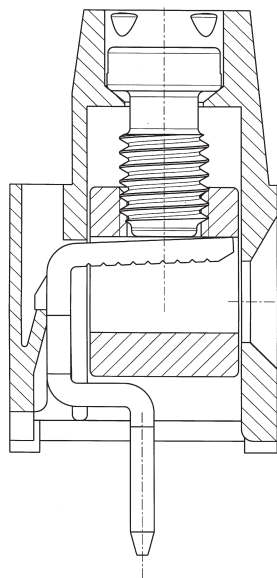

Cross Section Two-Piece Connector

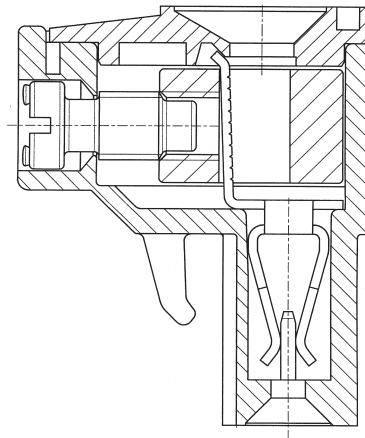

Note: All part numbers are RoHS Compliant.

Board Mount, Side Wire Entry

**Board Mount,
2.54 mm Centerline,
Side Wire Entry**
**UL Rating – 150 V, 10 A
16-30 AWG**

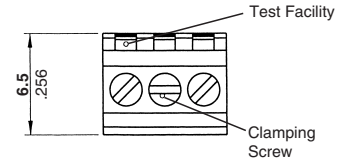
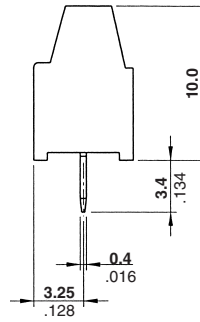
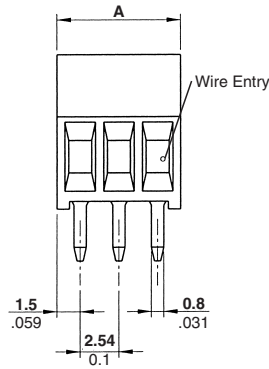
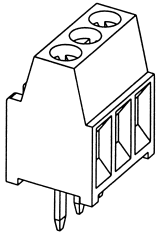

Recommended PC Board Layout

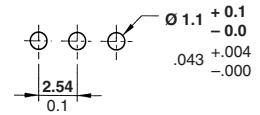

Suggested Screw Torque—
1.73 in.-lbs.

No. of Positions	Dim. A	Part Numbers	
		Green	Gray
2	5.54 [0.218]	282834-2	1546215-2
3	8.08 [0.318]	282834-3	1546215-3
4	10.62 [0.418]	282834-4	1546215-4
5	13.16 [0.518]	282834-5	1546215-5
6	15.70 [0.618]	282834-6	1546215-6
7	18.24 [0.718]	282834-7	1546215-7
8	20.78 [0.818]	282834-8	1546215-8
9	23.32 [0.918]	282834-9	1546215-9
10	25.86 [1.018]	1-282834-0	1-1546215-0
11	28.40 [1.118]	1-282834-1	1-1546215-1
12	30.94 [1.218]	1-282834-2	1-1546215-2

**Board Mount,
5.08 mm Centerline,
Side Wire Entry
Color – Green**
**UL Rating – 300 V, 10 A
16-30 AWG**

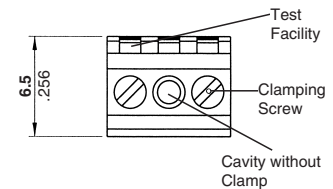
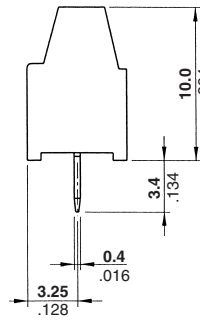
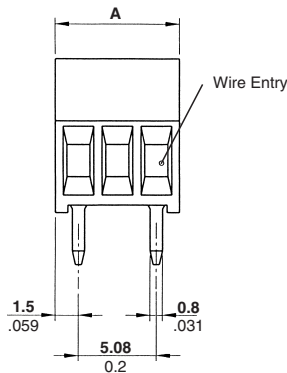
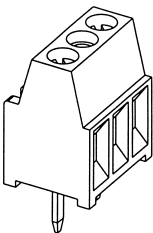

Recommended PC Board Layout

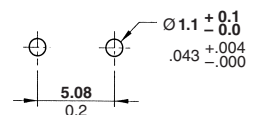

Suggested Screw Torque—
1.73 in.-lbs.

No. of Positions	Dim. A	Part Numbers
2	8.08 [0.318]	282835-2
3	13.16 [0.518]	282835-3
4	18.24 [0.718]	282835-4
5	23.32 [0.918]	282835-5
6	28.40 [1.118]	282835-6

Note: All part numbers are RoHS Compliant.

Board Mount, Side Wire Entry

Board Mount w/Interlock, 3.5 mm Centerline, Side Wire Entry

**UL Rating – 300 V, 12 A
14-30 AWG**

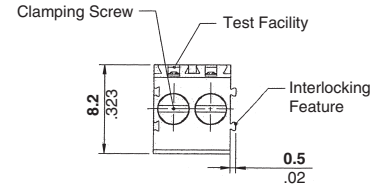
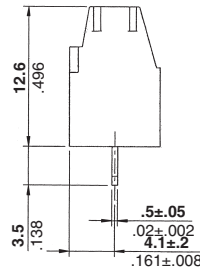
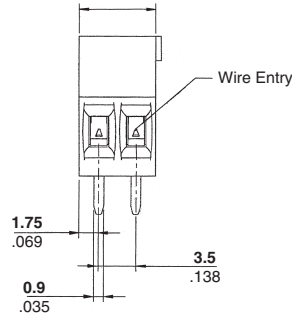
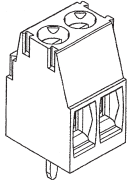

Recommended PC Board Layout

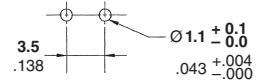

Suggested Screw Torque—
2.2 in.-lbs.

No. of Positions	Dim. A	Part Numbers	
		Green	Blue
2	7.0 [0.276]	284391-2	1546227-2
3	10.5 [0.413]	284391-3	1546227-3
4	14.0 [0.551]	284391-4	1546227-4
5	17.5 [0.689]	284391-5	1546227-5
6	21.0 [0.827]	284391-6	1546227-6
7	24.5 [0.965]	284391-7	1546227-7
8	28.0 [1.102]	284391-8	1546227-8
9	31.5 [1.240]	284391-9	1546227-9
10	35.0 [1.378]	1-284391-0	1-1546227-0
11	38.5 [1.516]	1-284391-1	1-1546227-1
12	42.0 [1.654]	1-284391-2	1-1546227-2
13	45.5 [1.791]	1-284391-3	1-1546227-3

No. of Positions	Dim. A	Part Numbers	
		Green	Blue
14	49.0 [1.929]	1-284391-4	1-1546227-4
15	52.5 [2.067]	1-284391-5	1-1546227-5
16	56.0 [2.205]	1-284391-6	1-1546227-6
17	59.5 [2.343]	1-284391-7	1-1546227-7
18	63.0 [2.480]	1-284391-8	1-1546227-8
19	66.5 [2.618]	1-284391-9	1-1546227-9
20	70.0 [2.756]	2-284391-0	2-1546227-0
21	73.5 [2.894]	2-284391-1	2-1546227-1
22	77.0 [3.031]	2-284391-2	2-1546227-2
23	80.5 [3.169]	2-284391-3	2-1546227-3
24	84.0 [3.307]	2-284391-4	2-1546227-4
25	87.5 [3.445]	2-284391-5	2-1546227-5

Board Mount 3.5 mm Centerline, Side Wire Entry

**UL Rating – 300 V, 12 A
16-28 AWG**

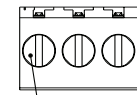
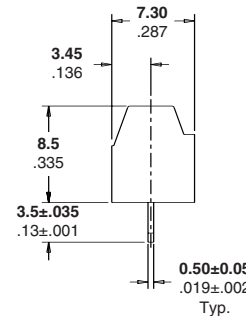
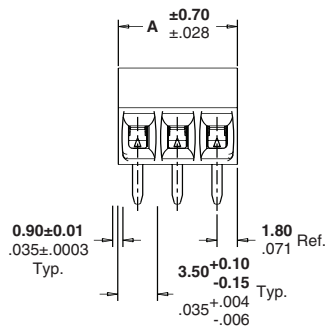
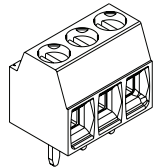

Recommended PC Board Layout

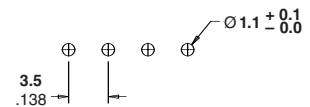

No. of Positions	Dim. A	Part Numbers	
		Black*	Green
2	7.00 [276]	1776112-2	1546551-2
3	10.50 [413]	1776112-3	1546551-3
4	14.00 [551]	1776112-4	1546551-4
5	17.50 [689]	—	1546551-5
6	21.00 [827]	—	1546551-6
7	24.50 [965]	—	1546551-7
8	28.00 [1.102]	—	1546551-8
9	31.50 [1.240]	—	1546551-9
10	35.00 [1.378]	—	1-1546551-0
11	38.50 [1.516]	—	1-1546551-1
12	42.00 [1.654]	—	1-1546551-2
13	45.50 [1.791]	—	1-1546551-3

No. of Positions	Dim. A	Part Numbers	
		Black*	Green
14	49.00 [1.929]	—	1-1546551-4
15	52.50 [2.067]	—	1-1546551-5
16	56.00 [2.205]	—	1-1546551-6
17	59.50 [2.343]	—	1-1546551-7
18	63.00 [2.480]	—	1-1546551-8
19	66.50 [2.618]	—	1-1546551-9
20	70.00 [2.756]	—	2-1546551-0
21	73.50 [2.894]	—	2-1546551-1
22	77.00 [3.031]	—	2-1546551-2
23	80.50 [3.169]	—	2-1546551-3
24	84.00 [3.307]	—	2-1546551-4
25	87.50 [3.445]	—	2-1546551-5

*Wave solder process capable to 265°C [509°F] for 10 seconds

Note: All part numbers are RoHS Compliant.

Board Mount, Side Wire Entry (Continued)

**Board Mount w/Interlock,
3.81 mm Centerline,
Side Wire Entry
Color – Green**

**UL Rating – 300 V, 12 A
14-30 AWG**

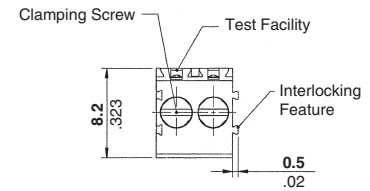
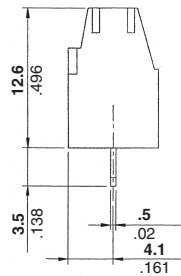
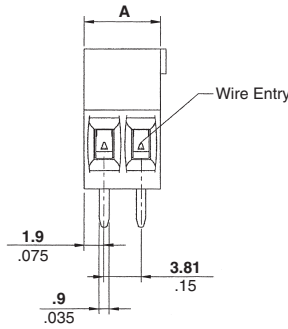
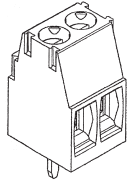

Recommended PC Board Layout

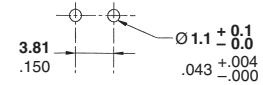

**Suggested Screw Torque—
2.2 in.-lbs.**

No. of Positions	Dim. A	Part Numbers
2	7.62 [0.300]	284392-2
3	11.43 [0.450]	284392-3
4	15.24 [0.600]	284392-4
5	19.05 [0.750]	284392-5
6	22.86 [0.900]	284392-6
7	26.67 [1.050]	284392-7
8	30.48 [1.200]	284392-8
9	34.29 [1.350]	284392-9
10	38.10 [1.500]	1-284392-0
11	41.91 [1.650]	1-284392-1
12	45.72 [1.800]	1-284392-2
13	49.53 [1.950]	1-284392-3

No. of Positions	Dim. A	Part Numbers
14	53.34 [2.100]	1-284392-4
15	57.15 [2.250]	1-284392-5
16	60.96 [2.400]	1-284392-6
17	64.77 [2.550]	1-284392-7
18	68.58 [2.700]	1-284392-8
19	72.39 [2.850]	1-284392-9
20	76.20 [3.000]	2-284392-0
21	80.01 [3.150]	2-284392-1
22	83.82 [3.300]	2-284392-2
23	87.63 [3.450]	2-284392-3
24	91.44 [3.600]	2-284392-4
25	95.25 [3.750]	2-284392-5

**Board Mount,
3.81 mm Centerline,
Side Wire Entry**

**UL Rating – 150 V, 12 A
16-28 AWG**

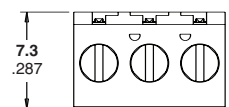
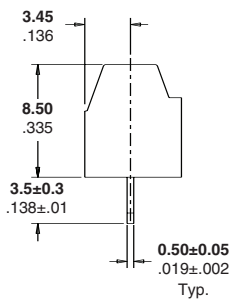
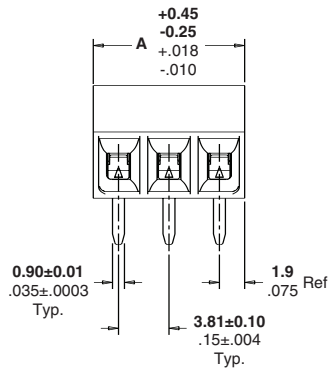
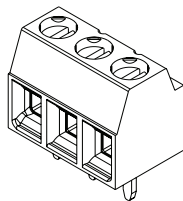

Recommended PC Board Layout

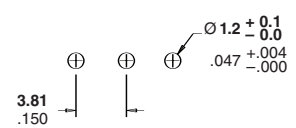

No. of Positions	Dim. A	Part Numbers	
		Black*	Green
2	7.62 [.300]	1776113-2	1546552-2
3	11.43 [.450]	1776113-3	1546552-3
4	15.24 [.600]	1776113-4	1546552-4
5	19.05 [.750]	1776113-5	1546552-5
6	22.86 [.900]	1776113-6	1546552-6
7	26.67 [1.050]	1776113-7	1546552-7
8	30.48 [1.200]	1776113-8	1546552-8
9	34.29 [1.350]	1776113-9	1546552-9
10	38.10 [1.500]	1-1776113-0	1-1546552-0
11	41.91 [1.650]	1-1776113-1	1-1546552-1
12	45.72 [1.800]	1-1776113-2	1-1546552-2
13	49.53 [1.950]	—	1-1546552-3

No. of Positions	Dim. A	Part Numbers	
		Black*	Green
14	53.34 [2.100]	—	1-1546552-4
15	57.15 [2.250]	—	1-1546552-5
16	60.96 [2.400]	—	1-1546552-6
17	64.77 [2.550]	—	1-1546552-7
18	68.58 [2.700]	—	1-1546552-8
19	72.39 [2.850]	—	1-1546552-9
20	76.20 [3.000]	—	2-1546552-0
21	80.01 [3.150]	—	2-1546552-1
22	83.82 [3.300]	—	2-1546552-2
23	87.63 [3.450]	—	2-1546552-3
24	91.44 [3.600]	—	2-1546552-4
25	95.25 [3.750]	—	2-1546552-5

*Wave solder process capable to 265°C [509°F] for 10 seconds

Note: All part numbers are RoHS Compliant.

Board Mount, Side Wire Entry (Continued)

Board Mount w/Interlock, Low Profile, 5.0 mm Centerline, Side Wire Entry

**UL Rating – 300 V, 13.5 A
16-30 AWG
10 A for field wiring applications**

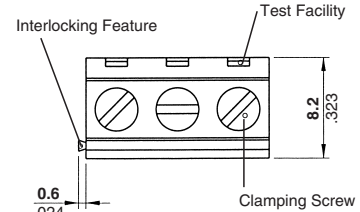
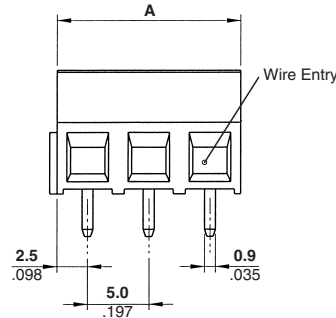
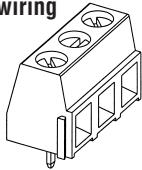

Suggested Screw Torque—
6.0 in.-lbs.

No. of Positions	Dim. A	Part Numbers		
		Green	Gray	Black*
2	10.0 [0.394]	282836-2	1546216-2	1776118-2
3	15.0 [0.591]	282836-3	1546216-3	1776118-3
4	20.0 [0.787]	282836-4	1546216-4	1776118-4
5	25.0 [0.984]	282836-5	1546216-5	1776118-5
6	30.0 [1.181]	282836-6	1546216-6	1776118-6
7	35.0 [1.378]	282836-7	1546216-7	1776118-7
8	40.0 [1.575]	282836-8	1546216-8	1776118-8
9	45.0 [1.772]	282836-9	1546216-9	—
10	50.0 [1.968]	1-282836-0	1-1546216-0	—
11	55.0 [2.165]	1-282836-1	1-1546216-1	—
12	60.0 [2.362]	1-282836-2	1-1546216-2	—
13	65.0 [2.559]	1-282836-4	1-1546216-3	—

No. of Positions	Dim. A	Part Numbers		
		Green	Gray	Black*
14	70.0 [2.756]	1-282836-5	1-1546216-4	—
15	75.0 [2.953]	1-282836-6	1-1546216-5	—
16	80.0 [3.150]	1-282836-7	1-1546216-6	—
17	85.0 [3.346]	1-282836-8	1-1546216-7	—
18	90.0 [3.543]	1-282836-9	1-1546216-8	—
19	95.0 [3.740]	2-282836-0	1-1546216-9	—
20	100.0 [3.937]	2-282836-1	2-1546216-0	—
21	105.0 [4.134]	2-282836-2	2-1546216-1	—
22	110.0 [4.331]	2-282836-3	2-1546216-2	—
23	115.0 [4.528]	2-282836-4	2-1546216-3	—
24	120.0 [4.724]	2-282836-5	2-1546216-4	—
25	125.0 [4.921]	2-282836-6	2-1546216-5	—

*Wave solder process capable to 265°C [509°F] for 10 seconds

Board Mount w/Interlock, Low Profile, 5.08 mm Centerline, Side Wire Entry

**UL Rating – 300 V, 13.5 A
16-30 AWG
10 A for field wiring applications**

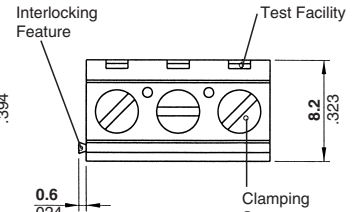
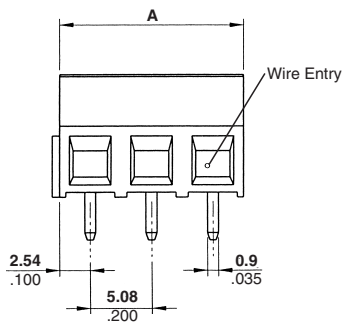
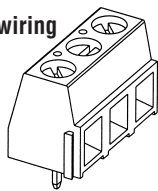

Suggested Screw Torque—
6.0 in.-lbs.

No. of Positions	Dim. A	Part Numbers		
		Green	Gray	Black*
2	10.16 [0.400]	282837-2	1546217-2	1776119-2
3	15.24 [0.600]	282837-3	1546217-3	1776119-3
4	20.32 [0.800]	282837-4	1546217-4	1776119-4
5	25.40 [1.000]	282837-5	1546217-5	1776119-5
6	30.48 [1.200]	282837-6	1546217-6	1776119-6
7	35.56 [1.400]	282837-7	1546217-7	1776119-7
8	40.64 [1.600]	282837-8	1546217-8	1776119-8
9	45.72 [1.800]	282837-9	1546217-9	—
10	50.80 [2.000]	1-282837-0	1-1546217-0	—
11	55.88 [2.200]	1-282837-1	1-1546217-1	—
12	60.96 [2.400]	1-282837-2	1-1546217-2	—
13	66.04 [2.600]	1-282837-6	1-1546217-6	—

No. of Positions	Dim. A	Part Numbers		
		Green	Gray	Black*
14	71.12 [2.800]	1-282837-7	1-1546217-7	—
15	76.20 [3.000]	1-282837-8	1-1546217-8	—
16	81.28 [3.200]	1-282837-9	1-1546217-9	—
17	86.36 [3.400]	2-282837-0	2-1546217-0	—
18	91.44 [3.600]	2-282837-1	2-1546217-1	—
19	96.52 [3.800]	2-282837-2	2-1546217-2	—
20	101.60 [4.000]	2-282837-3	2-1546217-3	—
21	106.68 [4.200]	2-282837-4	2-1546217-4	—
22	111.76 [4.400]	2-282837-5	2-1546217-5	—
23	116.84 [4.600]	2-282837-6	2-1546217-6	—
24	121.92 [4.800]	2-282837-7	2-1546217-7	—
25	127.00 [5.000]	2-282837-8	2-1546217-8	—

*Wave solder process capable to 265°C [509°F] for 10 seconds

Note: All part numbers are RoHS Compliant.

Board Mount, Side Wire Entry (Continued)

**Board Mount w/Interlock,
5.0 mm Centerline,
Side Wire Entry**

**UL Rating – 300 V, 17.5 A
12-30 AWG
15 A for field wiring
applications**

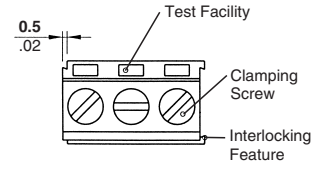
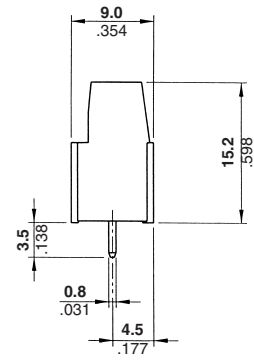
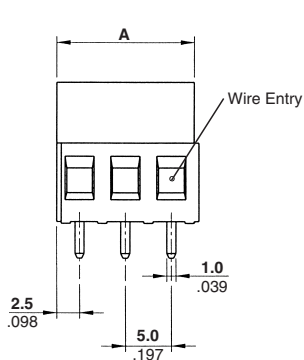
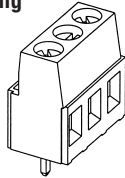

Recommended PC Board Layout

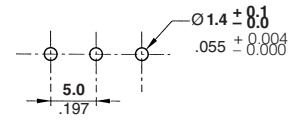

**Suggested Screw Torque—
7.0 in.-lbs.**

No. of Positions	Dim. A	Part Numbers		
		Green	Blue	Black
2	10.0 [0.394]	796683-2	796681-2	796682-2
3	15.0 [0.591]	796683-3	796681-3	796682-3
4	20.0 [0.787]	796683-4	796681-4	796682-4
5	25.0 [0.984]	796683-5	796681-5	796682-5
6	30.0 [1.181]	796683-6	796681-6	796682-6
7	35.0 [1.378]	796683-7	796681-7	796682-7
8	40.0 [1.575]	796683-8	796681-8	796682-8
9	45.0 [1.772]	796683-9	796681-9	796682-9
10	50.0 [1.968]	1-796683-0	1-796681-0	1-796682-0
11	55.0 [2.165]	1-796683-1	1-796681-1	1-796682-1
12	60.0 [2.362]	1-796683-2	1-796681-2	1-796682-2
13	65.0 [2.559]	1-796683-3	1-796681-3	1-796682-3

No. of Positions	Dim. A	Part Numbers		
		Green	Blue	Black
14	70.0 [2.756]	1-796683-4	1-796681-4	1-796682-4
15	75.0 [2.953]	1-796683-5	1-796681-5	1-796682-5
16	80.0 [3.150]	1-796683-6	1-796681-6	1-796682-6
17	85.0 [3.346]	1-796683-7	1-796681-7	1-796682-7
18	90.0 [3.543]	1-796683-8	1-796681-8	1-796682-8
19	95.0 [3.740]	1-796683-9	1-796681-9	1-796682-9
20	100.0 [3.937]	2-796683-0	2-796681-0	2-796682-0
21	105.0 [4.134]	2-796683-1	2-796681-1	2-796682-1
22	110.0 [4.331]	2-796683-2	2-796681-2	2-796682-2
23	115.0 [4.528]	2-796683-3	2-796681-3	2-796682-3
24	120.0 [4.724]	2-796683-4	2-796681-4	2-796682-4
25	125.0 [4.921]	2-796683-5	2-796681-5	2-796682-5

Note: BUCHANAN Terminal Block Series B02C4VxxT has been superceded/replaced with 796681-x.
RDI Terminal Block Series 5KEV-xx has been superceded/replaced with 796683-x (green) or 796682-x (black).

**Board Mount w/Interlock,
5.0 mm Centerline,
Side Wire Entry
Color – Green**

**UL Rating – 300 V, 24 A
12-30 AWG
20 A for field wiring
applications**

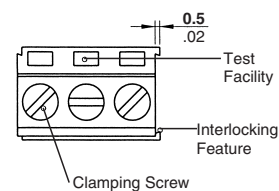
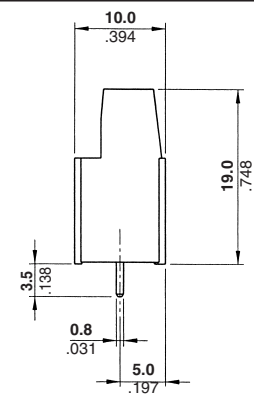
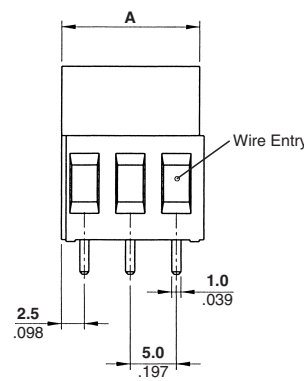
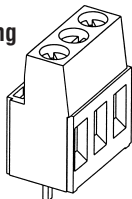

Recommended PC Board Layout

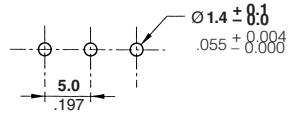

**Suggested Screw Torque—
7.0 in.-lbs.**

No. of Positions	Dim. A	Part Number
2	10.0 [.394]	282856-2
3	15.0 [.591]	282856-3
4	20.0 [.787]	282856-4
5	25.0 [.984]	282856-5
6	30.0 [1.181]	282856-6
7	35.0 [1.378]	282856-7
8	40.0 [1.575]	282856-8
9	45.0 [1.772]	282856-9
10	50.0 [1.968]	1-282856-0
11	55.0 [2.165]	1-282856-1
12	60.0 [2.362]	1-282856-2
13	65.0 [2.559]	1-282856-3

No. of Positions	Dim. A	Part Number
14	70.0 [2.756]	1-282856-5
15	75.0 [2.953]	1-282856-6
16	80.0 [3.150]	1-282856-7
17	85.0 [3.346]	1-282856-8
18	90.0 [3.543]	1-282856-9
19	95.0 [3.740]	2-282856-0
20	100.0 [3.937]	2-282856-1
21	105.0 [4.134]	2-282856-2
22	110.0 [4.331]	2-282856-3
23	115.0 [4.528]	2-282856-4
24	120.0 [4.724]	2-282856-5
25	125.0 [4.921]	2-282856-6

Note: All part numbers are RoHS Compliant.

Board Mount, Side Wire Entry (Continued)

Board Mount w/Interlock, 5.08 mm Centerline, Side Wire Entry

**UL Rating – 300 V, 17.5 A
12-30 AWG
15 A for field wiring applications**

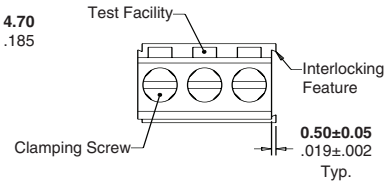
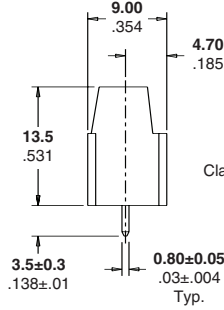
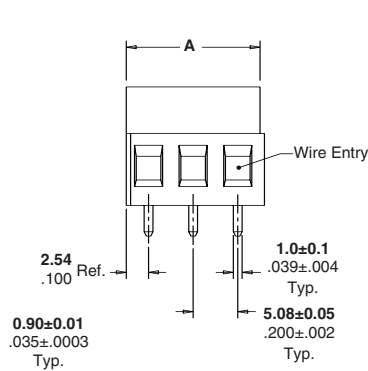
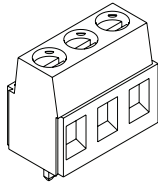

Recommended PC Board Layout

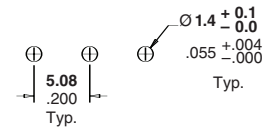

No. of Positions	Dim. A	Part Numbers	
		Black*	Green
2	10.16 [0.400]	1776126-2	796911-2
3	15.24 [0.600]	1776126-3	796911-3
4	20.32 [0.800]	—	796911-4
5	25.40 [1.000]	—	796911-5
6	30.48 [1.200]	—	796911-6
7	35.56 [1.400]	—	796911-7
8	40.64 [1.600]	—	796911-8
9	45.72 [1.800]	—	796911-9
10	50.80 [2.000]	—	1-796911-0
11	55.88 [2.200]	—	1-796911-1
12	60.96 [2.400]	—	1-796911-2
13	66.04 [2.600]	—	1-796911-3

*Wave solder process capable to 265°C [509°F] for 10 seconds

No. of Positions	Dim. A	Part Numbers	
		Black*	Green
14	71.12 [2.800]	—	1-796911-4
15	76.20 [3.000]	—	1-796911-5
16	81.28 [3.200]	—	1-796911-6
17	86.36 [3.400]	—	1-796911-7
18	91.44 [3.600]	—	1-796911-8
19	96.52 [3.800]	—	1-796911-9
20	101.60 [4.000]	—	2-796911-0
21	106.68 [4.200]	—	2-796911-1
22	111.76 [4.400]	—	2-796911-2
23	116.84 [4.600]	—	2-796911-3
24	121.92 [4.800]	—	2-796911-4
25	127.00 [5.000]	—	2-796911-5

Board Mount w/Interlock, 5.08 mm Centerline, Side Wire Entry

**UL Rating – 300 V, 17.5 A
12-30 AWG
15 A for field wiring applications**

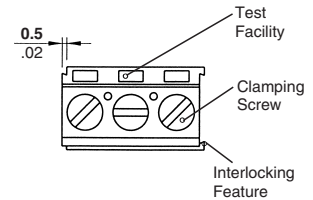
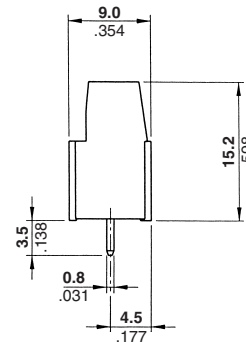
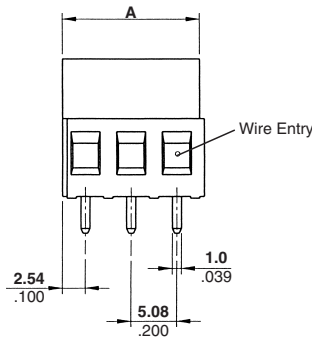
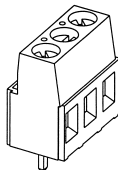

Recommended PC Board Layout

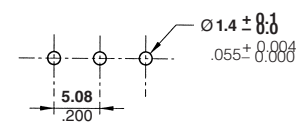

Suggested Screw Torque—
7.0 in.-lbs.

No. of Positions	Dim. A	Part Numbers		
		Green	Black	Gray
2	10.16 [0.400]	282841-2	796949-2	1546218-2
3	15.24 [0.600]	282841-3	796949-3	1546218-3
4	20.32 [0.800]	282841-4	796949-4	1546218-4
5	25.40 [1.000]	282841-5	796949-5	1546218-5
6	30.48 [1.200]	282841-6	796949-6	1546218-6
7	35.56 [1.400]	282841-7	796949-7	1546218-7
8	40.64 [1.600]	282841-8	796949-8	1546218-8
9	45.72 [1.800]	282841-9	796949-9	1546218-9
10	50.80 [2.000]	1-282841-0	1-796949-0	1-1546218-0
11	55.88 [2.200]	1-282841-1	1-796949-1	1-1546218-1
12	60.96 [2.400]	1-282841-2	1-796949-2	1-1546218-2
13	66.04 [2.600]	1-282841-6	1-796949-3	1-1546218-3

No. of Positions	Dim. A	Part Numbers		
		Green	Black	Gray
14	71.12 [2.800]	1-282841-7	1-796949-4	1-1546218-4
15	76.20 [3.000]	1-282841-8	1-796949-5	1-1546218-5
16	81.28 [3.200]	1-282841-9	1-796949-6	1-1546218-6
17	86.36 [3.400]	2-282841-0	1-796949-7	1-1546218-7
18	91.44 [3.600]	2-282841-1	1-796949-8	1-1546218-8
19	96.52 [3.800]	2-282841-2	1-796949-9	1-1546218-9
20	101.60 [4.000]	2-282841-3	2-796949-0	2-1546218-0
21	106.68 [4.200]	2-282841-4	2-796949-1	2-1546218-1
22	111.76 [4.400]	2-282841-5	2-796949-2	2-1546218-2
23	116.84 [4.600]	2-282841-6	2-796949-3	2-1546218-3
24	121.92 [4.800]	2-282841-7	2-796949-4	2-1546218-4
25	127.00 [5.000]	2-282841-8	2-796949-5	2-1546218-5

Note: All part numbers are RoHS Compliant.

Board Mount, Side Wire Entry (Continued)

Board Mount w/Interlock, 5.08 mm Centerline, Side Wire Entry
Color – Green

UL Rating – 300 V, 24 A
12-30 AWG
20 A for field wiring applications

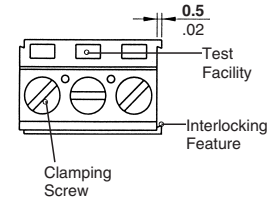
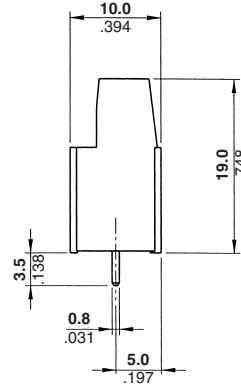
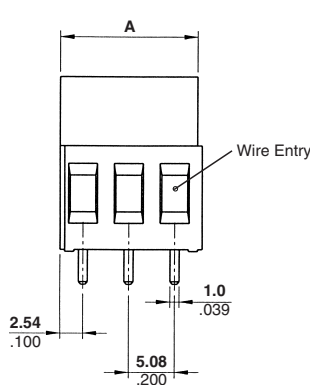
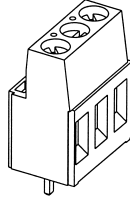

Recommended PC Board Layout

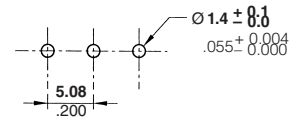

Suggested Screw Torque—
7.0 in.-lbs.

No. of Positions	Dim. A	Part Numbers
2	10.16 [0.400]	282857-2
3	15.24 [0.600]	282857-3
4	20.32 [0.800]	282857-4
5	25.40 [1.000]	282857-5
6	30.48 [1.200]	282857-6
7	35.56 [1.400]	282857-7
8	40.64 [1.600]	282857-8
9	45.72 [1.800]	282857-9
10	50.80 [2.000]	1-282857-0
11	55.88 [2.200]	1-282857-1
12	60.96 [2.400]	1-282857-2
13	66.04 [2.600]	1-282857-3

No. of Positions	Dim. A	Part Numbers
14	71.12 [2.800]	1-282857-4
15	76.20 [3.000]	1-282857-5
16	81.28 [3.200]	1-282857-6
17	86.36 [3.400]	1-282857-7
18	91.44 [3.600]	1-282857-8
19	96.52 [3.800]	1-282857-9
20	101.60 [4.000]	2-282857-0
21	106.68 [4.200]	2-282857-1
22	111.76 [4.400]	2-282857-2
23	116.84 [4.600]	2-282857-3
24	121.92 [4.800]	2-282857-4
25	127.00 [5.000]	2-282857-5

Board Mount w/Interlock, 7.5 mm Centerline, Side Wire Entry
Color – Green

UL Rating – 300 V, 17.5 A
12-30 AWG
15 A for field wiring applications

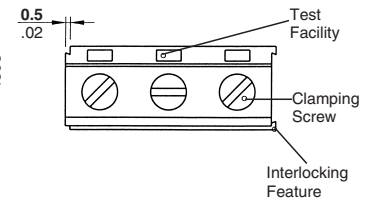
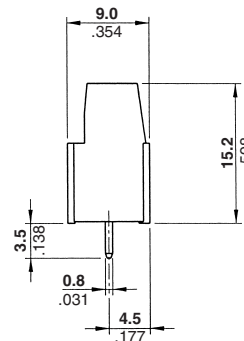
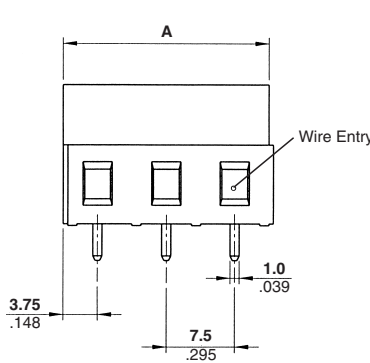
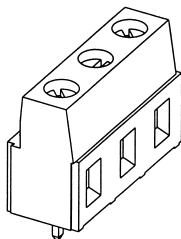

Recommended PC Board Layout

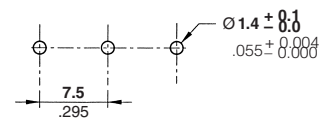

Suggested Screw Torque—
7.0 in.-lbs.

No. of Positions	Dim. A	Part Numbers
2	15.0 [0.591]	282844-2
3	22.5 [0.886]	282844-3
4	30.0 [1.181]	282844-4

Note: All part numbers are RoHS Compliant.

Board Mount, Side Wire Entry (Continued)

Board Mount w/Interlock, 7.5 mm Centerline, Side Wire Entry
UL Rating – 300 V, 24 A
12-30 AWG
20 A for field wiring applications

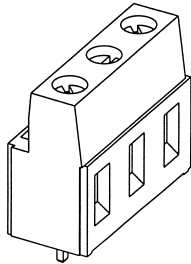

Suggested Screw Torque—
 7.0 in.-lbs.

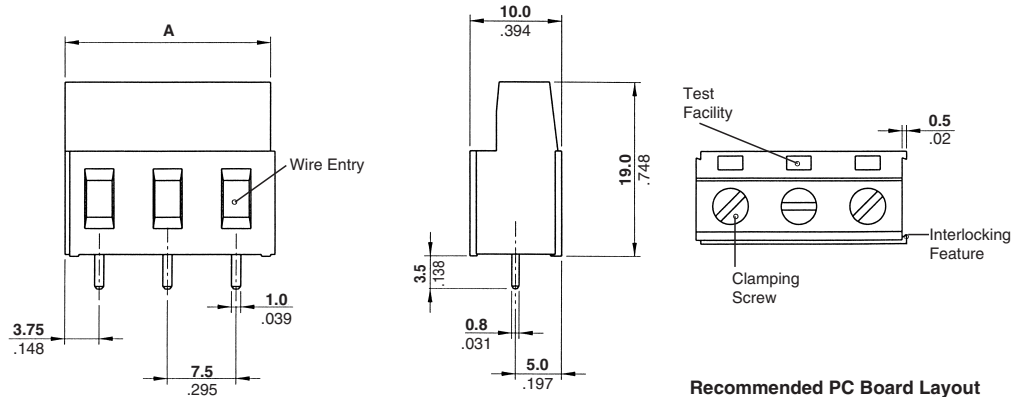

Recommended PC Board Layout

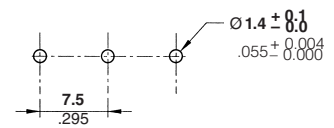

No. of Positions	Dim. A	Part Numbers	
		Green	Black
2	15.0 [0.591]	282860-2	1546062-2
3	22.5 [0.886]	282860-3	1546062-3
4	30.0 [1.181]	282860-4	1546062-4

Board Mount w/Interlock, 7.62 mm Centerline, Side Wire Entry
Color – Green
UL Rating – 300 V, 17.5 A
12-30 AWG
15 A for field wiring applications

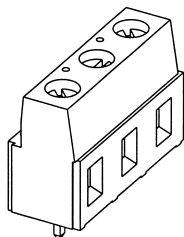

Suggested Screw Torque—
 7.0 in.-lbs.

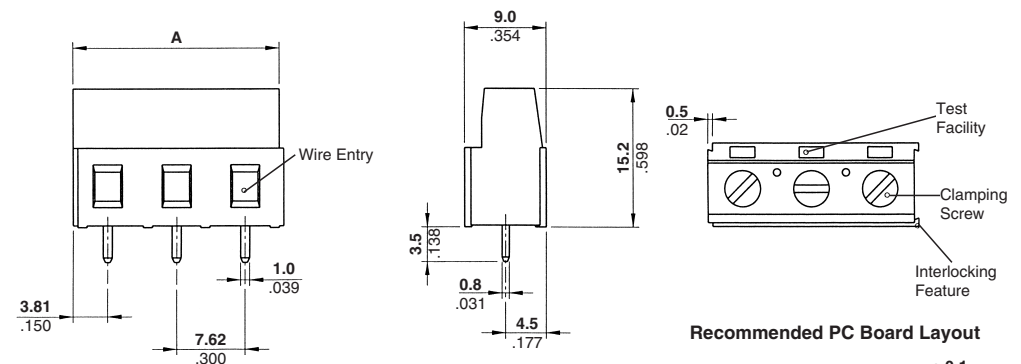

Recommended PC Board Layout

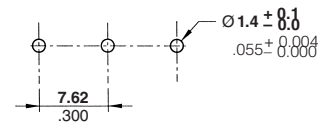

No. of Positions	Dim. A	Part Numbers
2	15.24 [.600]	282845-2
3	22.86 [.900]	282845-3

Note: All part numbers are RoHS Compliant.

Board Mount, Side Wire Entry (Continued)

Board Mount w/Interlock, 7.62 mm Centerline, Side Wire Entry Color – Green

**UL Rating – 300 V, 24 A
12-30 AWG
20 A for field wiring applications**

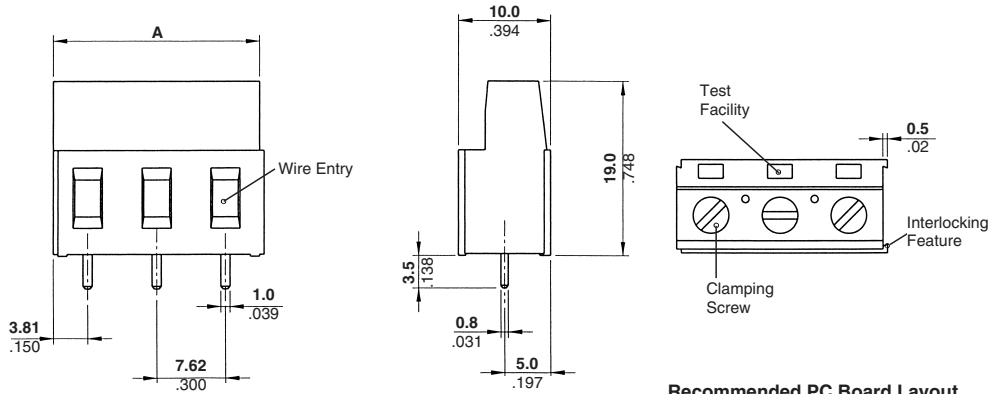
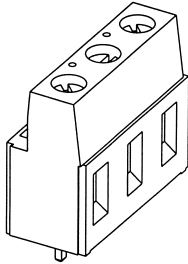

Recommended PC Board Layout

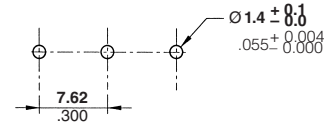

Suggested Screw Torque—
7.0 in.-lbs.

No. of Positions	Dim. A	Part Numbers
2	15.24 [.600]	282861-2
3	22.86 [.900]	282861-3

Board Mount, Low Profile, 10.0 mm Centerline, Side Wire Entry

**UL Rating – 600 V, 13.5 A
16-30 AWG
10 A for field wiring applications**

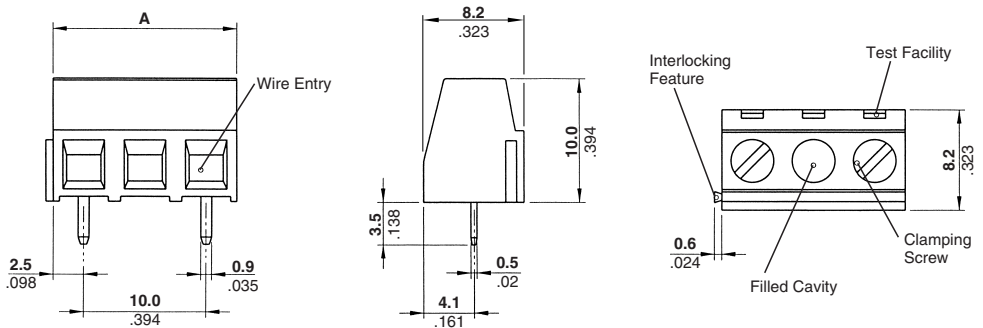
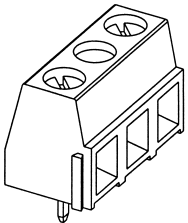

Recommended PC Board Layout

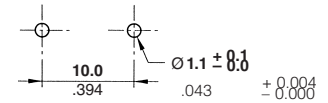

Suggested Screw Torque—
6.0 in.-lbs.

No. of Positions	Dim. A	Part Numbers	
		Green	Black*
2	15.0 [0.591]	282838-2	1776112-2
3	25.0 [0.984]	282838-3	1776112-3
4	35.0 [1.378]	282838-4	1776112-4
5	45.0 [1.772]	282838-5	—
6	55.0 [2.165]	282838-6	—
7	65.0 [2.559]	282838-8	—
8	75.0 [2.953]	282838-9	—
9	85.0 [3.346]	1-282838-0	—
10	95.0 [3.740]	1-282838-1	—
11	105.0 [4.134]	1-282838-2	—
12	115.0 [4.528]	1-282838-3	—
13	125.0 [4.921]	1-282838-4	—

*Wave solder process capable to 265°C [509°F] for 10 seconds

Note: All part numbers are RoHS Compliant.

Board Mount, Side Wire Entry (Continued)

Board Mount
10.0 mm Centerline,
Side Wire Entry
Color – Green
UL Rating – 600 V, 17.5 A
12-30 AWG
15 A for field wiring applications

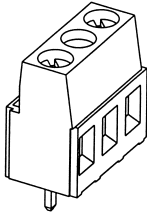

Suggested Screw Torque—
 7.0 in.-lbs.

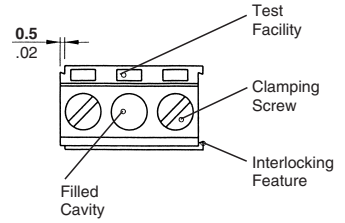
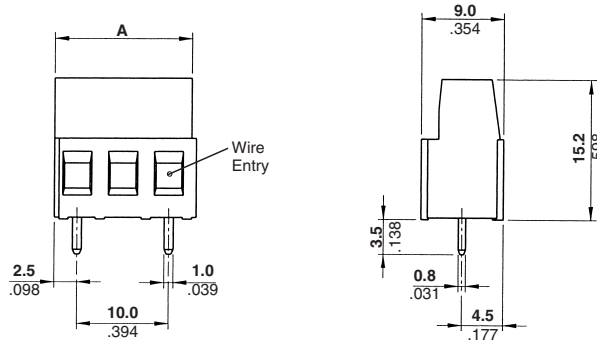

Recommended PC Board Layout

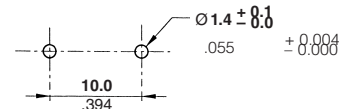

No. of Positions	Dim. A	Part Numbers
2	15.0 [0.591]	282842-2
3	25.0 [0.984]	282842-3
4	35.0 [1.378]	282842-4
5	45.0 [1.772]	282842-5
6	55.0 [2.165]	282842-6
7	65.0 [2.559]	282842-7
8	75.0 [2.953]	282842-8
9	85.0 [3.346]	282842-9
10	95.0 [3.740]	1-282842-0
11	105.0 [4.134]	1-282842-1
12	115.0 [4.528]	1-282842-2
13	125.0 [4.921]	1-282842-3

Board Mount
10.0 mm Centerline,
Side Wire Entry
Color – See Chart
UL Rating – 600 V, 24 A
12-30 AWG
20 A for field wiring applications

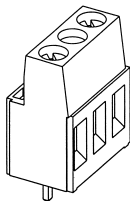

Suggested Screw Torque—
 7.0 in.-lbs.

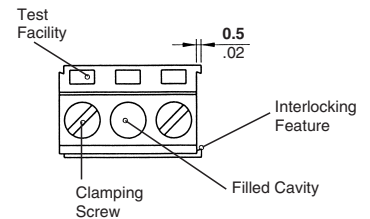
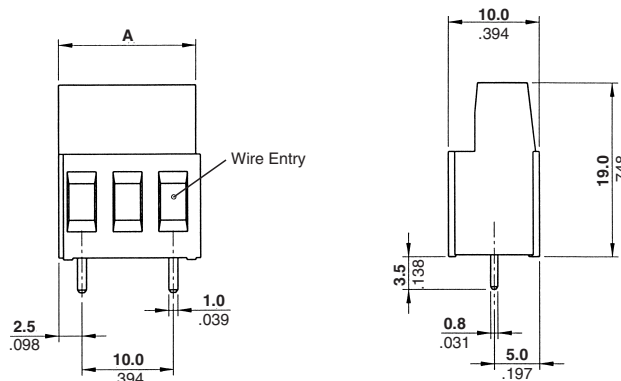

Recommended PC Board Layout

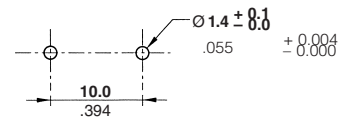

No. of Positions	Dim. A	Part Numbers	
		Green	Blue
2	15.0 [0.591]	282858-2	796704-2
3	25.0 [0.984]	282858-3	796704-3
4	35.0 [1.378]	282858-4	796704-4
5	45.0 [1.772]	282858-5	796704-5
6	55.0 [2.165]	282858-6	796704-6
7	65.0 [2.559]	282858-7	796704-7

No. of Positions	Dim. A	Part Numbers	
		Green	Blue
8	75.0 [2.953]	282858-8	796704-8
9	85.0 [3.346]	282858-9	796704-9
10	95.0 [3.740]	1-282858-0	1-796704-0
11	105.0 [4.134]	1-282858-1	1-796704-1
12	115.0 [4.528]	1-282858-2	1-796704-2
13	125.0 [4.921]	1-282858-3	1-796704-3

Note: BUCHANAN Terminal Block Series B03C5VxxT has been superceded/replaced with 796704-x.



Note: All part numbers are RoHS Compliant.

Board Mount, Side Wire Entry (Continued)

Board Mount w/Interlock, Low Profile, 10.16 mm Centerline, Side Wire Entry

UL Rating – 300 V, 13.5 A 16-30 AWG 15 A for field wiring applications

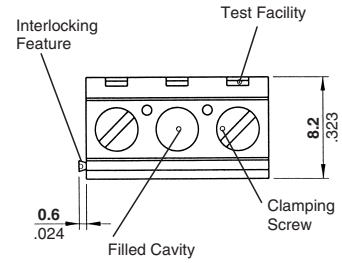
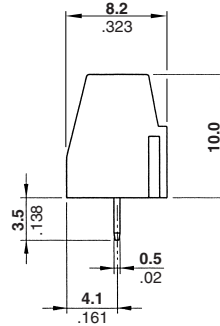
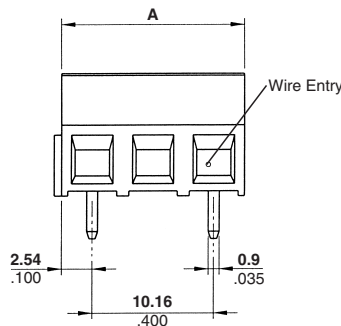
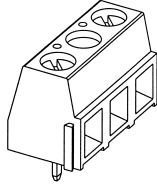

Recommended PC Board Layout

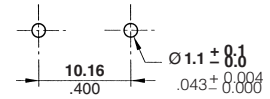

Suggested Screw Torque—
6.0 in.-lbs.

No. of Positions	Dim. A	Part Numbers	
		Green	Black*
2	15.24 [0.600]	282839-2	1776123-2
3	25.40 [1.000]	282839-3	1776123-3
4	35.56 [1.400]	282839-4	1776123-4
5	45.72 [1.800]	282839-5	—
6	55.88 [2.200]	282839-6	—
7	66.04 [2.600]	282839-7	—

*Wave solder process capable to 265°C [509°F] for 10 seconds

No. of Positions	Dim. A	Part Numbers	
		Green	Black*
8	76.20 [3.000]	282839-8	—
9	86.36 [3.400]	282839-9	—
10	96.52 [3.800]	1-282839-0	—
11	106.68 [4.200]	1-282839-1	—
12	116.84 [4.600]	1-282839-2	—
13	127.00 [5.000]	1-282839-3	—

Board Mount 10.16 mm Centerline, Side Wire Entry Color – Green

UL Rating – 600 V, 17.5 A 12-30 AWG 15 A for field wiring applications

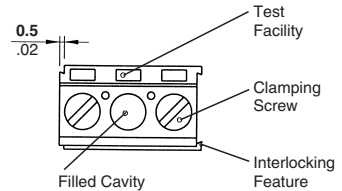
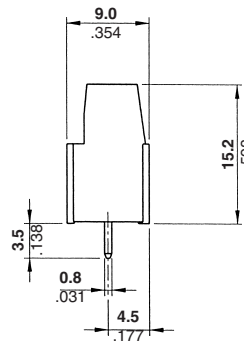
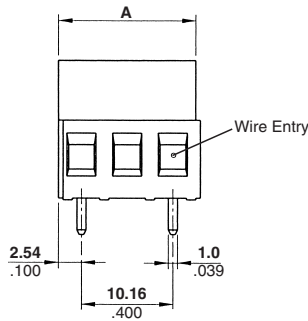
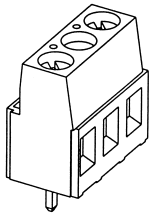

Recommended PC Board Layout

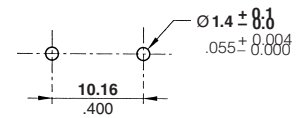

Suggested Screw Torque—
7.0 in.-lbs.

No. of Positions	Dim. A	Part Numbers
2	15.24 [0.600]	282843-2
3	25.40 [1.000]	282843-3
4	35.56 [1.400]	282843-4
5	45.72 [1.800]	282843-5
6	55.88 [2.200]	282843-6
7	66.04 [2.600]	282843-7

No. of Positions	Dim. A	Part Numbers
8	76.20 [3.000]	282843-8
9	86.36 [3.400]	282843-9
10	96.52 [3.800]	1-282843-0
11	106.68 [4.200]	1-282843-1
12	116.84 [4.600]	1-282843-2
13	127.00 [5.000]	1-282843-3

Note: All part numbers are RoHS Compliant.

Board Mount, Top Wire Entry

Board Mount w/Interlock, 3.5 mm Centerline, Top Wire Entry, Color – Green

UL Rating – 300 V, 12 A 14-30 AWG

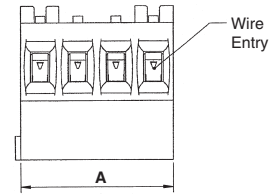
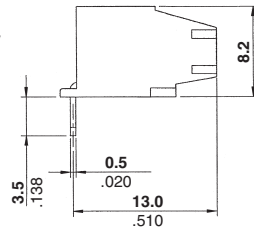
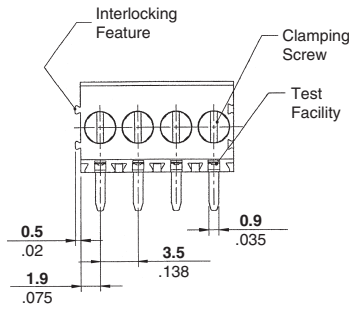
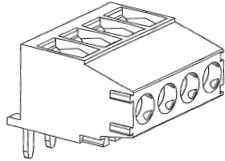

Recommended PC Board Layout

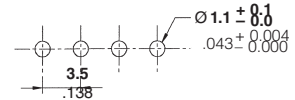

Suggested Screw Torque—
2.2 in.-lbs.

No. of Positions	Dim. A	Part Numbers
2	7.0 [0.276]	284414-2
3	10.5 [0.413]	284414-3
4	14.0 [0.551]	284414-4
5	17.5 [0.689]	284414-5
6	21.0 [0.827]	284414-6
7	24.5 [0.965]	284414-7
8	28.0 [1.102]	284414-8
9	31.5 [1.240]	284414-9
10	35.0 [1.378]	1-284414-0
11	38.5 [1.516]	1-284414-1
12	42.0 [1.654]	1-284414-2
13	45.5 [1.791]	1-284414-3

No. of Positions	Dim. A	Part Numbers
14	49.0 [1.929]	1-284414-4
15	52.5 [2.067]	1-284414-5
16	56.0 [2.205]	1-284414-6
17	59.5 [2.343]	1-284414-7
18	63.0 [2.480]	1-284414-8
19	66.5 [2.618]	1-284414-9
20	70.0 [2.756]	2-284414-0
21	73.5 [2.894]	2-284414-1
22	77.0 [3.031]	2-284414-2
23	80.5 [3.169]	2-284414-3
24	84.0 [3.307]	2-284414-4
25	87.5 [3.445]	2-284414-5

Board Mount w/Interlock, 3.81 mm Centerline, Top Wire Entry, Color – Green

UL Rating – 300 V, 12 A 14-30 AWG

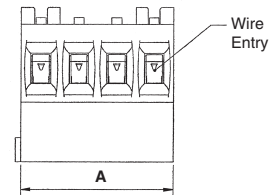
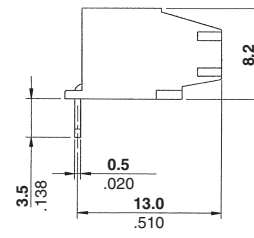
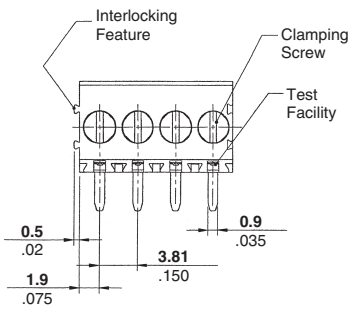
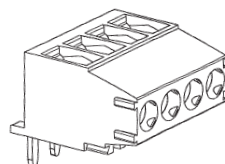

Recommended PC Board Layout

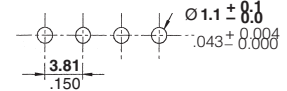

Suggested Screw Torque—
2.2 in.-lbs.

No. of Positions	Dim. A	Part Numbers
2	7.62 [0.300]	284415-2
3	11.43 [0.450]	284415-3
4	15.24 [0.600]	284415-4
5	19.05 [0.750]	284415-5
6	22.86 [0.900]	284415-6
7	26.67 [1.050]	284415-7
8	30.48 [1.200]	284415-8
9	34.29 [1.350]	284415-9
10	38.10 [1.500]	1-284415-0
11	41.91 [1.650]	1-284415-1
12	45.72 [1.800]	1-284415-2
13	49.53 [1.950]	1-284415-3

No. of Positions	Dim. A	Part Numbers
14	53.34 [2.100]	1-284415-4
15	57.15 [2.250]	1-284415-5
16	60.96 [2.400]	1-284415-6
17	64.77 [2.550]	1-284415-7
18	68.58 [2.700]	1-284415-8
19	72.39 [2.850]	1-284415-9
20	76.20 [3.000]	2-284415-0
21	80.01 [3.150]	2-284415-1
22	83.82 [3.300]	2-284415-2
23	87.63 [3.450]	2-284415-3
24	91.44 [3.600]	2-284415-4
25	95.25 [3.750]	2-284415-5

Note: All part numbers are RoHS Compliant.

Board Mount, Top Wire Entry (Continued)

**Board Mount, Low Profile
5.0 mm Centerline,
Top Wire Entry**
**UL Rating – 300 V, 13.5 A
16-30 AWG
10 A for field wiring applications**

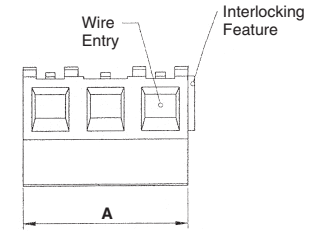
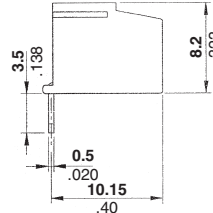
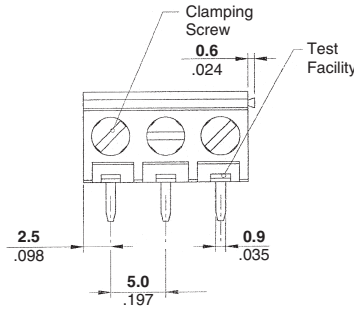
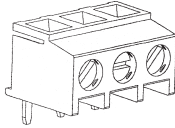

Recommended PC Board Layout

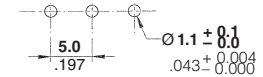

Suggested Screw Torque—
6.0 in.-lbs.

No. of Positions	Dim. A	Part Numbers		
		Green	Gray	Black*
2	10.0 [0.394]	284093-2	1546225-2	1776120-2
3	15.0 [0.591]	284093-3	1546225-3	1776120-3
4	20.0 [0.787]	284093-4	1546225-4	1776120-4
5	25.0 [0.984]	284093-5	1546225-5	1776120-5
6	30.0 [1.181]	284093-6	1546225-6	1776120-6
7	35.0 [1.378]	284093-7	1546225-7	1776120-7
8	40.0 [1.575]	284093-8	1546225-8	1776120-8
9	45.0 [1.772]	284093-9	1546225-9	—
10	50.0 [1.968]	1-284093-0	1-1546225-0	—
11	55.0 [2.165]	1-284093-1	1-1546225-1	—
12	60.0 [2.362]	1-284093-2	1-1546225-2	—
13	65.0 [2.559]	1-284093-3	1-1546225-3	—

No. of Positions	Dim. A	Part Numbers		
		Green	Gray	Black*
14	70.0 [2.756]	1-284093-4	1-1546225-4	—
15	75.0 [2.953]	1-284093-5	1-1546225-5	—
16	80.0 [3.150]	1-284093-6	1-1546225-6	—
17	85.0 [3.346]	1-284093-7	1-1546225-7	—
18	90.0 [3.543]	1-284093-8	1-1546225-8	—
19	95.0 [3.740]	1-284093-9	1-1546225-9	—
20	100.0 [3.937]	2-284093-0	2-1546225-0	—
21	105.0 [4.134]	2-284093-1	2-1546225-1	—
22	110.0 [4.331]	2-284093-2	2-1546225-2	—
23	115.0 [4.528]	2-284093-3	2-1546225-3	—
24	120.0 [4.724]	2-284093-4	2-1546225-4	—
25	125.0 [4.921]	2-284093-5	2-1546225-5	—

*Wave solder process capable to 265°C [509°F] for 10 seconds

**Board Mount w/Interlock,
5.0 mm Centerline,
Top Wire Entry**
**UL Rating – 300 V, 17.5 A
12-30 AWG
15 A for field wiring applications**

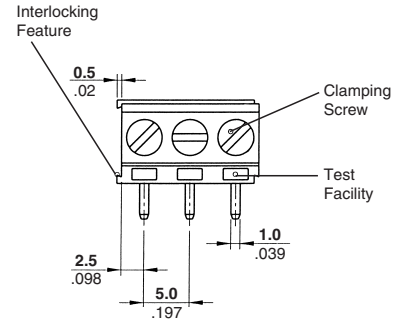
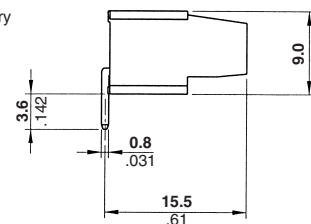
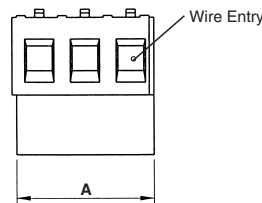
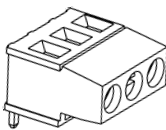

Recommended PC Board Layout

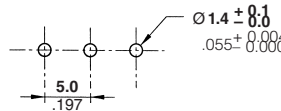

Suggested Screw Torque—
7.0 in.-lbs.

No. of Positions	Dim. A	Part Numbers	
		Green	Blue
2	10.0 [0.394]	796748-2	796684-2
3	15.0 [0.591]	796748-3	796684-3
4	20.0 [0.787]	796748-4	796684-4
5	25.0 [0.984]	796748-5	796684-5
6	30.0 [1.181]	796748-6	796684-6
7	35.0 [1.378]	796748-7	796684-7
8	40.0 [1.575]	796748-8	796684-8
9	45.0 [1.772]	796748-9	796684-9
10	50.0 [1.968]	1-796748-0	1-796684-0
11	55.0 [2.165]	1-796748-1	1-796684-1
12	60.0 [2.362]	1-796748-2	1-796684-2
13	65.0 [2.559]	1-796748-3	1-796684-3

No. of Positions	Dim. A	Part Numbers	
		Green	Blue
14	70.0 [2.756]	1-796748-4	1-796684-4
15	75.0 [2.953]	1-796748-5	1-796684-5
16	80.0 [3.150]	1-796748-6	1-796684-6
17	85.0 [3.346]	1-796748-7	1-796684-7
18	90.0 [3.543]	1-796748-8	1-796684-8
19	95.0 [3.740]	1-796748-9	1-796684-9
20	100.0 [3.937]	2-796748-0	2-796684-0
21	105.0 [4.134]	2-796748-1	2-796684-1
22	110.0 [4.331]	2-796748-2	2-796684-2
23	115.0 [4.528]	2-796748-3	2-796684-3
24	120.0 [4.724]	2-796748-4	2-796684-4
25	125.0 [4.921]	2-796748-5	2-796684-5

Note: BUCHANAN Terminal Block Series B02C4HxxT has been superseded/replaced with 796684-xx (blue).

Note: All part numbers are RoHS Compliant.

Board Mount, Top Wire Entry (Continued)

Board Mount w/Interlock, 5.0 mm Centerline, Top Wire Entry
Color – Green
UL Rating – 300 V, 24 A
12-30 AWG
20 A for field wiring applications

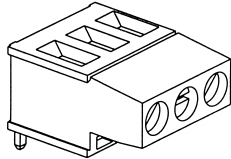

Suggested Screw Torque—
 7.0 in.-lbs.

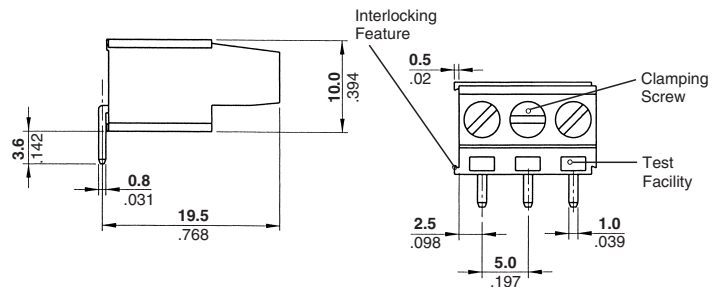
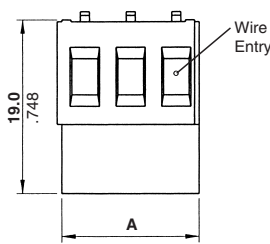

Recommended PC Board Layout

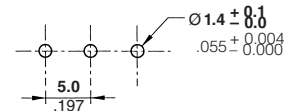

No. of Positions	Dim. A	Part Numbers
2	10.0 [.394]	282862-2
3	15.0 [.591]	282862-3
4	20.0 [.787]	282862-4
5	25.0 [.984]	282862-5
6	30.0 [1.181]	282862-6
7	35.0 [1.378]	282862-7
8	40.0 [1.575]	282862-8
9	45.0 [1.772]	282862-9
10	50.0 [1.968]	1-282862-0
11	55.0 [2.165]	1-282862-1
12	60.0 [2.362]	1-282862-2
13	65.0 [2.559]	1-282862-3

No. of Positions	Dim. A	Part Numbers
14	70.0 [2.756]	1-282862-4
15	75.0 [2.953]	1-282862-5
16	80.0 [3.150]	1-282862-6
17	85.0 [3.346]	1-282862-7
18	90.0 [3.543]	1-282862-8
19	95.0 [3.740]	1-282862-9
20	100.0 [3.937]	2-282862-0
21	105.0 [4.134]	2-282862-1
22	110.0 [4.331]	2-282862-2
23	115.0 [4.528]	2-282862-3
24	120.0 [4.724]	2-282862-4
25	125.0 [4.921]	2-282862-5

Board Mount w/Interlock, Low Profile, 5.08 mm Centerline, Top Wire Entry
UL Rating – 300 V, 13.5 A
16-30 AWG
10 A for field wiring applications

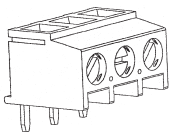

Suggested Screw Torque—
 6.0 in.-lbs.

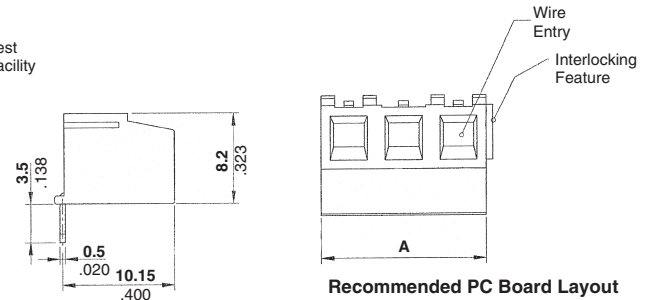
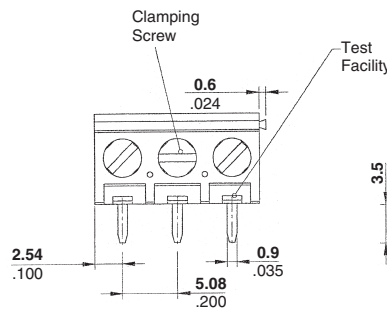

Recommended PC Board Layout

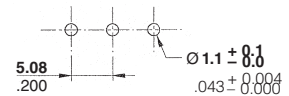

No. of Positions	Dim. A	Part Numbers	
		Green	Black*
2	10.16 [0.400]	284094-2	1776121-2
3	15.24 [0.600]	284094-3	1776121-3
4	20.32 [0.800]	284094-4	1776121-4
5	25.40 [1.000]	284094-5	1776121-5
6	30.48 [1.200]	284094-6	1776121-6
7	35.56 [1.400]	284094-7	1776121-7
8	40.64 [1.600]	284094-8	1776121-8
9	45.72 [1.800]	284094-9	—
10	50.80 [2.000]	1-284094-0	—
11	55.88 [2.200]	1-284094-1	—
12	60.96 [2.400]	1-284094-2	—
13	66.04 [2.600]	1-284094-3	—

No. of Positions	Dim. A	Part Numbers	
		Green	Black*
14	71.12 [2.800]	1-284094-4	—
15	76.20 [3.000]	1-284094-5	—
16	81.28 [3.200]	1-284094-6	—
17	86.36 [3.400]	1-284094-7	—
18	91.44 [3.600]	1-284094-8	—
19	96.52 [3.800]	1-284094-9	—
20	101.60 [4.000]	2-284094-0	—
21	106.68 [4.200]	2-284094-1	—
22	111.76 [4.400]	2-284094-2	—
23	116.84 [4.600]	2-284094-3	—
24	121.92 [4.800]	2-284094-4	—
25	127.00 [5.000]	2-284094-5	—

*Wave solder process capable to 265°C [509°F] for 10 seconds

Note: All part numbers are RoHS Compliant.

Board Mount, Top Wire Entry (Continued)

Board Mount w/Interlock, 5.08 mm Centerline, Top Wire Entry
UL Rating – 300 V, 17.5 A
12-30 AWG
15 A for field wiring applications

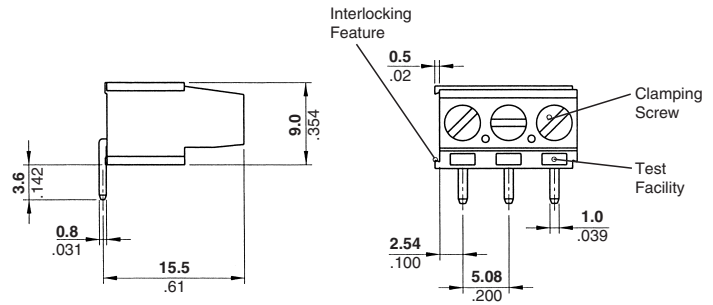
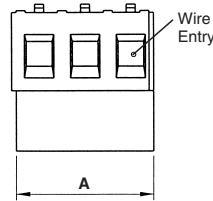
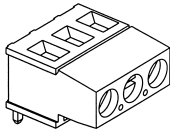

Recommended PC Board Layout

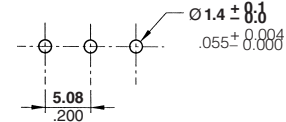

Suggested Screw Torque—
 7.0 in.-lbs.

No. of Positions	Dim. A	Part Numbers	
		Green	Black
2	10.16 [0.400]	282851-2	1546073-2
3	15.24 [0.600]	282851-3	1546073-3
4	20.32 [0.800]	282851-4	1546073-4
5	25.40 [1.000]	282851-5	1546073-5
6	30.48 [1.200]	282851-6	1546073-6
7	35.56 [1.400]	282851-7	1546073-7
8	40.64 [1.600]	282851-8	1546073-8
9	45.72 [1.800]	282851-9	1546073-9
10	50.80 [2.000]	1-282851-0	1-1546073-0
11	55.88 [2.200]	1-282851-1	1-1546073-1
12	60.96 [2.400]	1-282851-2	1-1546073-2
13	66.04 [2.600]	1-282851-3	1-1546073-3

No. of Positions	Dim. A	Part Numbers	
		Green	Black
14	71.12 [2.800]	1-282851-4	1-1546073-4
15	76.20 [3.000]	1-282851-5	1-1546073-5
16	81.28 [3.200]	1-282851-6	1-1546073-6
17	86.36 [3.400]	1-282851-7	1-1546073-7
18	91.44 [3.600]	1-282851-8	1-1546073-8
19	96.52 [3.800]	1-282851-9	1-1546073-9
20	101.60 [4.000]	2-282851-0	2-1546073-0
21	106.68 [4.200]	2-282851-1	2-1546073-1
22	111.76 [4.400]	2-282851-2	2-1546073-2
23	116.84 [4.600]	2-282851-3	2-1546073-3
24	121.92 [4.800]	2-282851-4	2-1546073-4
25	127.00 [5.000]	2-282851-5	2-1546073-5

Board Mount w/Interlock, 5.08 mm Centerline, Top Wire Entry Color – Green
UL Rating – 300 V, 24 A
12-30 AWG
20 A for field wiring applications

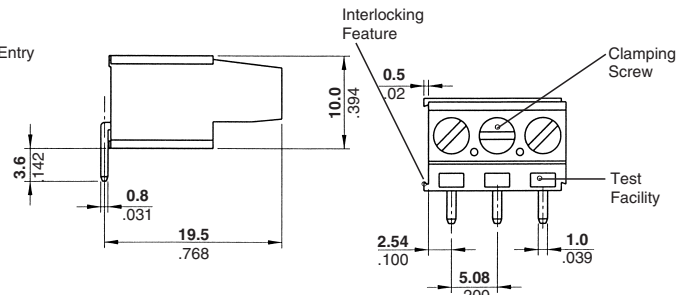
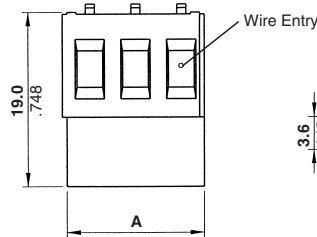
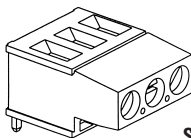

Recommended PC Board Layout

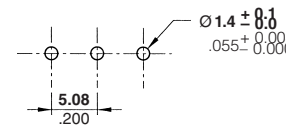

Suggested Screw Torque—
 7.0 in.-lbs.

No. of Positions	Dim. A	Part Numbers
2	10.16 [0.400]	282863-2
3	15.24 [0.600]	282863-3
4	20.32 [0.800]	282863-4
5	25.40 [1.000]	282863-5
6	30.48 [1.200]	282863-6
7	35.56 [1.400]	282863-7
8	40.64 [1.600]	282863-8
9	45.72 [1.800]	282863-9
10	50.80 [2.000]	1-282863-0
11	55.88 [2.200]	1-282863-1
12	60.96 [2.400]	1-282863-2
13	66.04 [2.600]	1-282863-3

No. of Positions	Dim. A	Part Numbers
14	71.12 [2.800]	1-282863-4
15	76.20 [3.000]	1-282863-5
16	81.28 [3.200]	1-282863-6
17	86.36 [3.400]	1-282863-7
18	91.44 [3.600]	1-282863-8
19	96.52 [3.800]	1-282863-9
20	101.60 [4.000]	2-282863-0
21	106.68 [4.200]	2-282863-1
22	111.76 [4.400]	2-282863-2
23	116.84 [4.600]	2-282863-3
24	121.92 [4.800]	2-282863-4
25	127.00 [5.000]	2-282863-5

Note: All part numbers are RoHS Compliant.

Board Mount, Top Wire Entry (Continued)

Top Wire Entry
7.5 mm Centerline,
Color – Green
UL Rating – 300 V, 17.5 A
12-30 AWG
15 A for field wiring applications

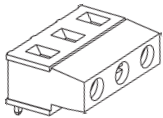

Suggested Screw Torque—
7.0 in.-lbs.

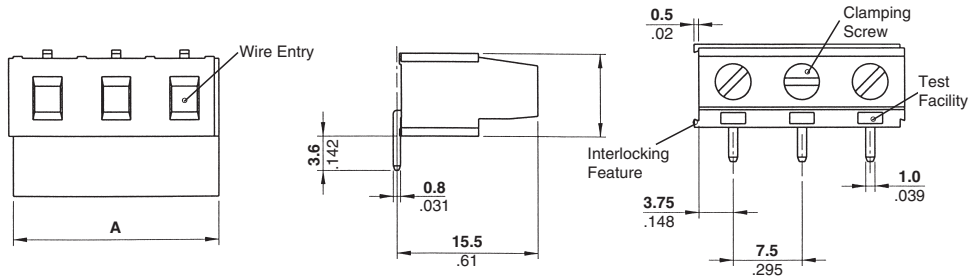

No. of Positions	Dim. A	Part Numbers
2	15.0 [0.591]	282854-2
3	22.5 [0.886]	282854-3
4	30.0 [1.181]	282854-4

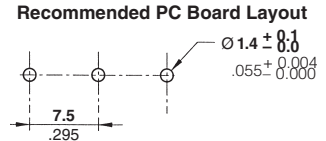

Top Wire Entry
7.62 mm Centerline,
Color – Green
UL Rating – 300 V, 17.5 A
12-30 AWG
15 A for field wiring applications

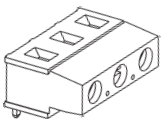

Suggested Screw Torque—
7.0 in.-lbs.

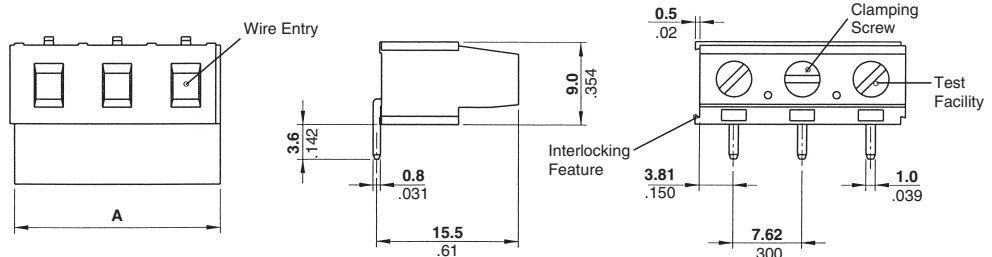

No. of Positions	Dim. A	Part Numbers
2	15.24 [.600]	282855-2
3	22.86 [.900]	282855-3

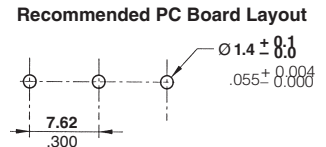

Top Wire Entry
7.62 mm Centerline,
Color – Green
UL Rating – 300 V, 24 A
12-30 AWG
20 A for field wiring applications

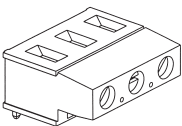

Suggested Screw Torque—
7.0 in.-lbs.

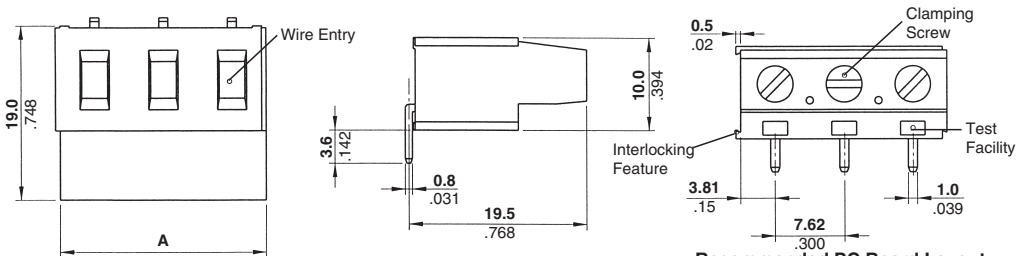

No. of Positions	Dim. A	Part Numbers
2	15.24 [.600]	282867-2
3	22.86 [.900]	282867-3

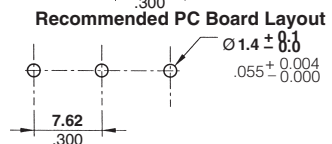

Note: All part numbers are RoHS Compliant.

Board Mount, Top Wire Entry (Continued)

Board Mount, Low Profile
10.0 mm Centerline,
Top Wire Entry,
Color – Black
UL Rating – 600 V, 13.5 A
16-30 AWG
10 A for field wiring applications

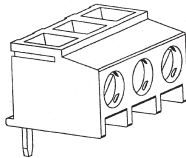

Suggested Screw Torque—
 6.0 in.-lbs.

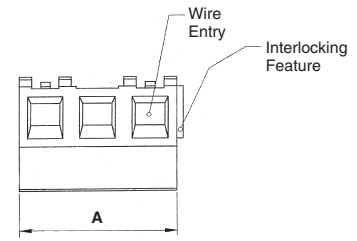
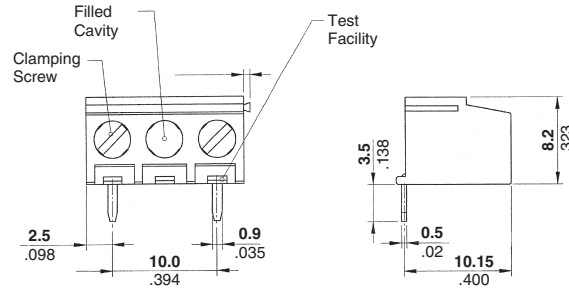

Recommended PC Board Layout

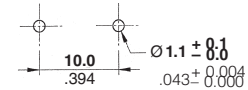

No. of Positions	Dim. A	Part Numbers
2	15.0 [.591]	1776124-2
3	20.0 [.787]	1776124-3
4	25.0 [.984]	1776124-4

Wave solder process capable to 265°C [509°F] for 10 seconds

Board Mount
10.0 mm Centerline,
Top Wire Entry
Color – Green
UL Rating – 600 V, 17.5 A
12-30 AWG
15 A for field entry applications

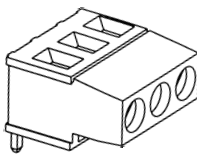

Suggested Screw Torque—
 7.0 in.-lbs.

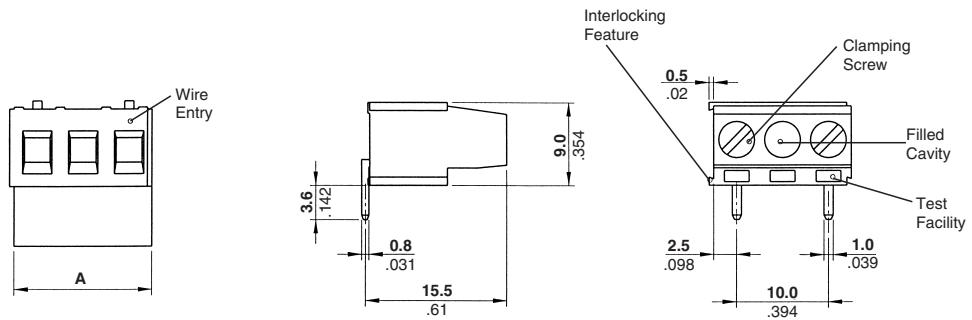

Recommended PC Board Layout

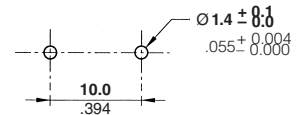

No. of Positions	Dim. A	Part Numbers
2	15.0 [.591]	282852-2
3	20.0 [.787]	282852-3
4	25.0 [.984]	282852-4
5	30.0 [1.181]	282852-5
6	35.0 [1.378]	282852-6
7	40.0 [1.575]	282852-7
8	45.0 [1.772]	282852-8
9	50.0 [1.968]	282852-9
10	55.0 [2.165]	1-282852-0
11	60.0 [2.362]	1-282852-1
12	65.0 [2.559]	1-282852-2
13	70.0 [2.775]	1-282852-3

Note: All part numbers are RoHS Compliant.

Board Mount, Top Wire Entry (Continued)

Board Mount, Low Profile, 10.16 mm Centerline, Top Wire Entry
Color – Black

UL Rating – 600 V, 13.5 A
16-30 AWG
10 A for field wiring applications

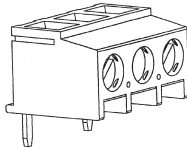

Suggested Screw Torque—
6.0 in.-lbs.

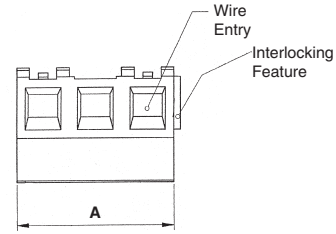
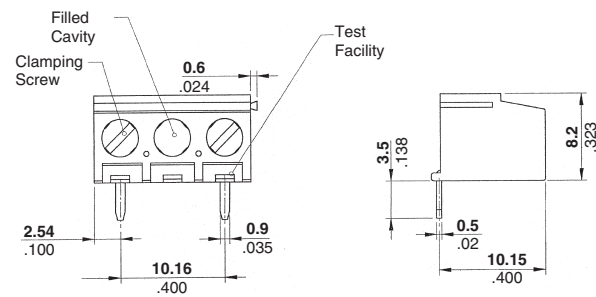

No. of Positions	Dim. A	Part Numbers
2	15.24 [0.600]	1776125-2
3	20.32 [0.800]	1776125-3
4	25.40 [1.000]	1776125-4

Recommended PC Board Layout

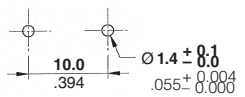

Wave solder process capable to 265°C [509°F] for 10 seconds

Board Mount, 10.16 mm Centerline, Top Wire Entry
Color – Green

UL Rating – 600 V, 17.5 A
12-30 AWG
15 A for field wiring applications

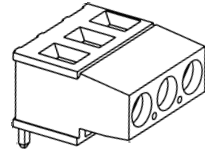

Suggested Screw Torque—
7.0 in.-lbs.

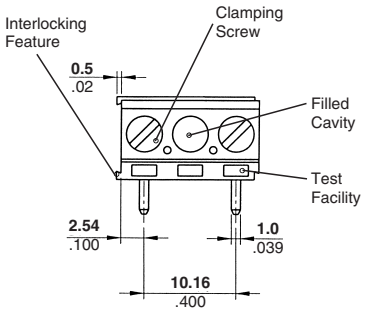
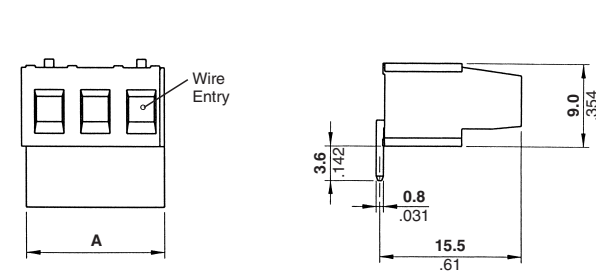

No. of Positions	Dim. A	Part Numbers
2	15.24 [0.600]	282853-2
3	20.32 [0.800]	282853-3
4	25.40 [1.000]	282853-4
5	30.48 [1.200]	282853-5
6	35.56 [1.400]	282853-6
7	40.64 [1.600]	282853-7
8	45.72 [1.800]	282853-8
9	50.80 [2.000]	282853-9
10	55.88 [2.200]	1-282853-0
11	60.96 [2.400]	1-282853-1
12	66.04 [2.600]	1-282853-2
13	71.12 [2.800]	1-282853-3

Recommended PC Board Layout

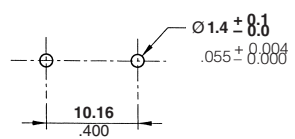

Note: All part numbers are RoHS Compliant.

Board Mount, 35° Angled Wire Entry

**Board Mount w/Interlock,
5.0 mm Centerline,
35° Angled Wire Entry**
**UL Rating – 300 V, 17.5 A
12-30 AWG
15 A for field wiring applications**

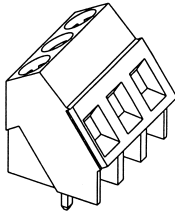

Suggested Screw Torque—
7.0 in.-lbs.

Notes:

1. BUCHANAN Terminal Block Series B04C4VXXT has been superceded/replaced with part number 796688-xx (blue color) and 796689-xx (black color).
2. RDI Terminal Block Series 5LEA-XX has been superceded/replaced with part number 796690-xx (green color).
3. RDI Terminal Block Series 5LEA-XX-1 has been superceded/replaced with part number 796689-xx (black color).

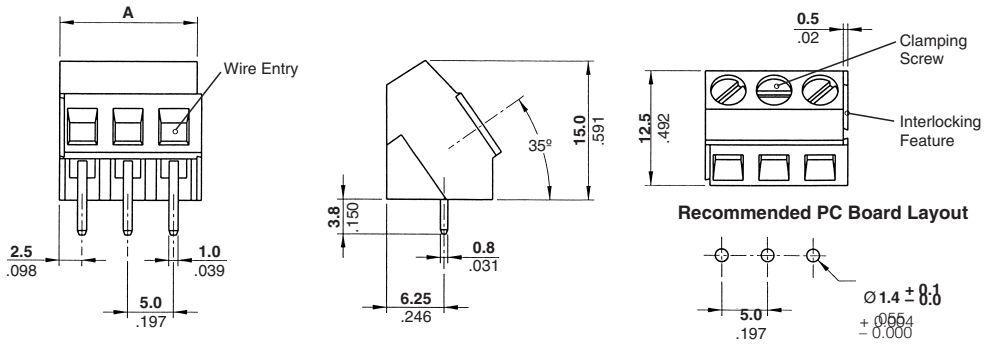

No. of Positions	Dim. A	Part Numbers			
		Gray	Blue	Black	Green
2	10.0 [0.394]	1546219-2	796688-2	796689-2	796690-2
3	15.0 [0.591]	1546219-3	796688-3	796689-3	796690-3
4	20.0 [0.787]	1546219-4	796688-4	796689-4	796690-4
5	25.0 [0.984]	1546219-5	796688-5	796689-5	796690-5
6	30.0 [1.181]	1546219-6	796688-6	796689-6	796690-6
7	35.0 [1.378]	1546219-7	796688-7	796689-7	796690-7
8	40.0 [1.575]	1546219-8	796688-8	796689-8	796690-8
9	45.0 [1.772]	1546219-9	796688-9	796689-9	796690-9
10	50.0 [1.968]	1-1546219-0	1-796688-0	1-796689-0	1-796690-0
11	55.0 [2.165]	1-1546219-1	1-796688-1	1-796689-1	1-796690-1
12	60.0 [2.362]	1-1546219-2	1-796688-2	1-796689-2	1-796690-2

**Board Mount w/Interlock,
5.08 mm Centerline,
35° Angled Wire Entry**
**UL Rating – 300 V, 17.5 A
12-30 AWG
15 A for field wiring applications**

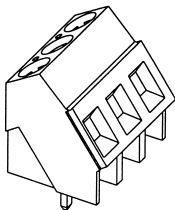

Suggested Screw Torque—
7.0 in.-lbs.

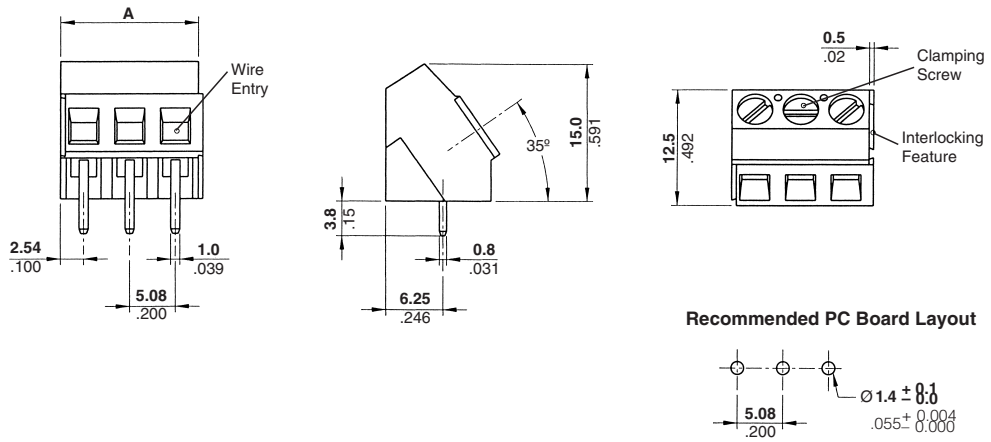

No. of Positions	Dim. A	Part Numbers		
		Gray	Green	Black
2	10.16 [0.400]	1546220-2	282847-2	1546074-2
3	15.24 [0.600]	1546220-3	282847-3	1546074-3
4	20.32 [0.800]	1546220-4	282847-4	1546074-4
5	25.40 [1.000]	1546220-5	282847-5	1546074-5
6	30.48 [1.200]	1546220-6	282847-6	1546074-6
7	35.56 [1.400]	1546220-7	282847-7	1546074-7
8	40.64 [1.600]	1546220-8	282847-8	1546074-8
9	45.72 [1.800]	1546220-9	282847-9	1546074-9
10	50.80 [2.000]	1-1546220-0	1-282847-0	1-1546074-0
11	55.88 [2.200]	1-1546220-1	1-282847-1	1-1546074-1
12	60.96 [2.400]	1-1546220-2	1-282847-2	1-1546074-2

Note: RDI Terminal Block Series 2EEA-xx has been superceded/replaced with 282847-xx series.

Note: All part numbers are RoHS Compliant.

Board Mount, 35° Angled Wire Entry (Continued)

**Board Mount,
10.0 mm Centerline,
35° Angled Wire Entry
Color – Green**
**UL Rating – 600 V, 17.5 A
12-30 AWG
15 A for field wiring applications**

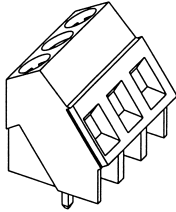

Suggested Screw Torque—
7.0 in.-lbs.

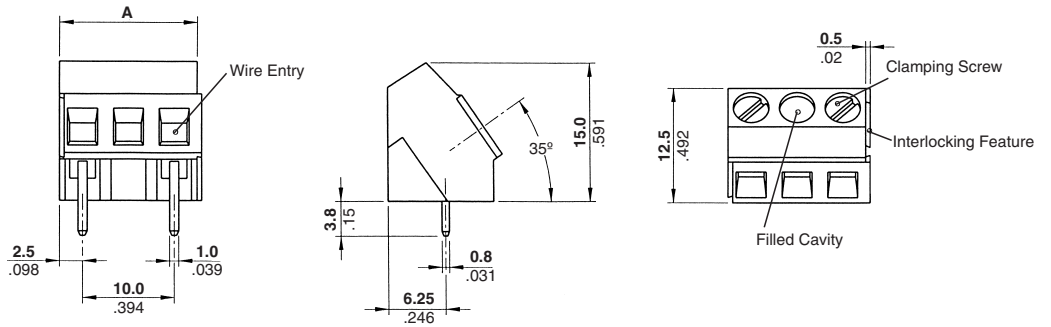

No. of Positions	Dim. A	Part Numbers
2	15.0 [0.591]	282848-2
3	25.0 [0.984]	282848-3
4	35.0 [1.378]	282848-4
5	45.0 [1.772]	282848-5
6	55.0 [2.165]	282848-6

Recommended PC Board Layout

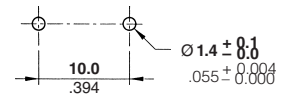

**Board Mount,
10.16 mm Centerline,
35° Angled Wire Entry
Color – Green**
**UL Rating – 600 V, 17.5 A
12-30 AWG
15 A for field wiring applications**

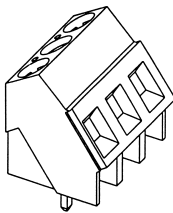

Suggested Screw Torque—
7.0 in.-lbs.

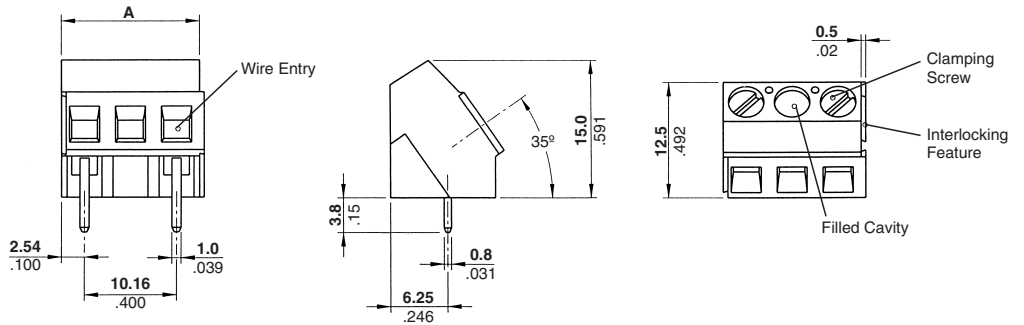

No. of Positions	Dim. A	Part Numbers
2	15.24 [0.600]	282849-2
3	25.40 [1.000]	282849-3
4	35.56 [1.400]	282849-4
5	45.72 [1.800]	282849-5
6	55.88 [2.200]	282849-6

Recommended PC Board Layout

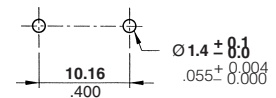

Note: All part numbers are RoHS Compliant.

Board Mount, Bottom Wire Entry

**Board Mount w/Interlock,
5.0 mm Centerline,
270° Bottom Wire Entry
Color – Green**

**UL Rating – 300 V, 17.5 A
12-30 AWG
15 A for field wiring applications**

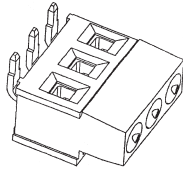

Suggested Screw Torque—
7.0 in.-lbs.

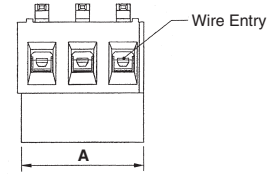
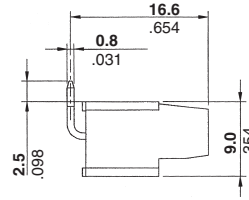
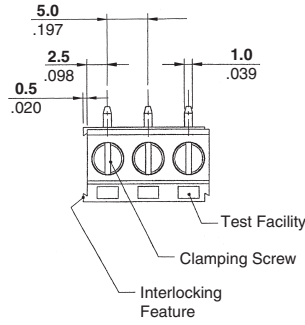

Recommended PC Board Layout

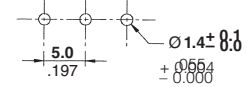

No. of Positions	Dim. A	Part Numbers
2	10.0 [0.394]	284410-2
3	15.0 [0.591]	284410-3
4	20.0 [0.787]	284410-4
5	25.0 [0.984]	284410-5
6	30.0 [1.181]	284410-6
7	35.0 [1.378]	284410-7
8	40.0 [1.575]	284410-8
9	45.0 [1.772]	284410-9
10	50.0 [1.968]	1-284410-0
11	55.0 [2.165]	1-284410-1
12	60.0 [2.362]	1-284410-2
13	65.0 [2.559]	1-284410-3
14	70.0 [2.756]	1-284410-4
15	75.0 [2.953]	1-284410-5
16	80.0 [3.150]	1-284410-6
17	85.0 [3.346]	1-284410-7
18	90.0 [3.543]	1-284410-8
19	95.0 [3.740]	1-284410-9
20	100.0 [3.937]	2-284410-0
21	105.0 [4.134]	2-284410-1
22	110.0 [4.331]	2-284410-2
23	115.0 [4.528]	2-284410-3
24	120.0 [4.724]	2-284410-4
25	125.0 [4.921]	2-284410-5

Note: All part numbers are RoHS Compliant.

High Current PCB Mount, Side Wire Entry

Product Facts

- Available in (2) centerline spacings: 6.35 mm and 9.52 mm pitch
- (2) position sizes available: 2 and 3 position
- Wire range: 10-24 AWG
- Available in (3) wire entry configurations: side wire, top wire and 35° angle

- Cage clamp style termination
- Product is modular; designed with a dovetail feature to allow building larger position sizes to increase the number of available wire positions
- Green color; other colors available upon request

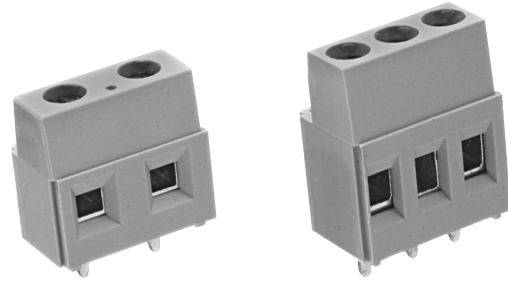

Board Mount w/Interlock, 6.35 mm Centerline, Side Wire Entry, Color – Green

UL Rating—300 V, 30 A 10-24 AWG

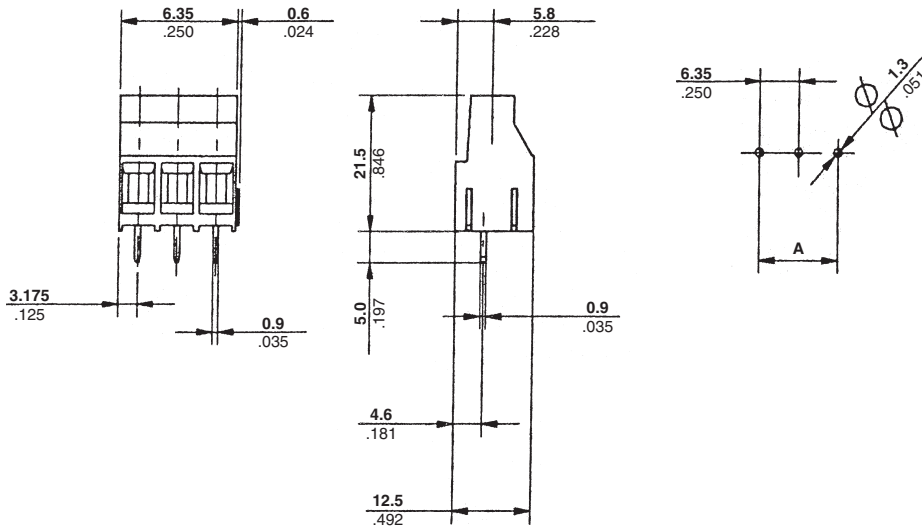

Suggested Screw Torque—
7.0 in.-lbs.

No. of Positions	Dim. A	Part Numbers
2	6.35 0.250	796740-2
3	12.70 0.500	796740-3

Board Mount w/Interlock, 9.52 mm Centerline, Side Wire Entry, Color – Green

UL Rating—600 V, 30 A 10-24 AWG

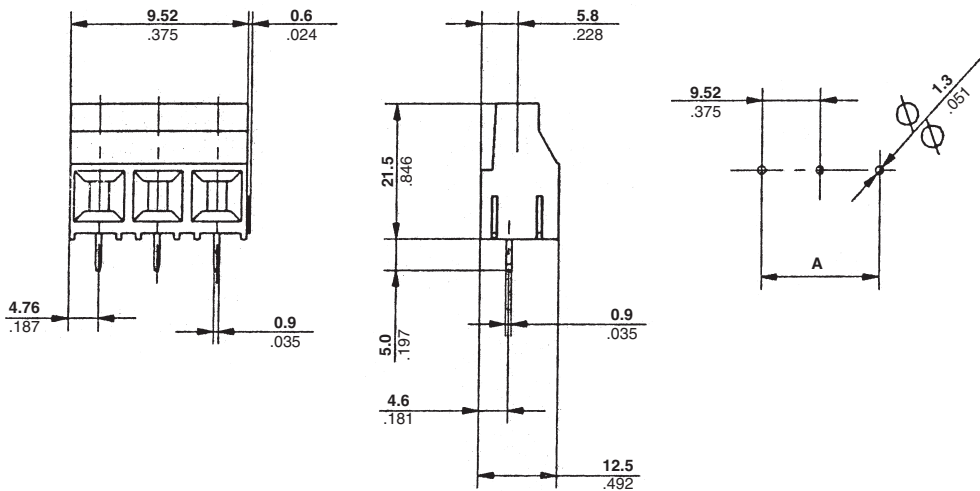

Suggested Screw Torque—
7.0 in.-lbs.

No. of Positions	Dim. A	Part Numbers
2	9.52 0.375	796739-2
3	19.04 0.704	796739-3

Note: All part numbers are RoHS Compliant.

High Current PCB Mount, 35° Angled Wire Entry

**Board Mount w/Interlock,
9.52 mm Centerline,
35° Wire Entry
Color – Green**

**UL Rating – 600 V, 30 A
10-24 AWG**

**Suggested Screw Torque—
7.0 in.-lbs.**

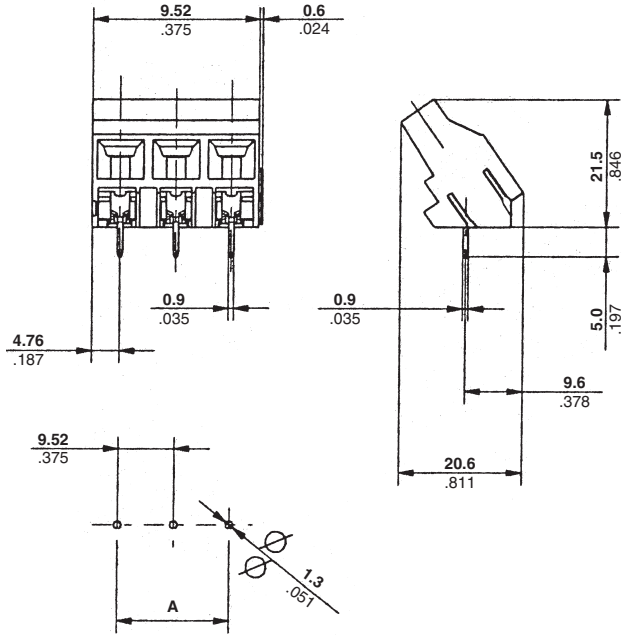

No. of Positions	Dim. A	Part Numbers
2	9.52 0.375	796741-2
3	19.04 0.704	796741-3

**Board Mount w/Interlock,
10.16 mm Centerline,
Side Wire Entry
Color – Green or Black**

**UL Rating – 300 V, 52 A
6-8 AWG**

**Suggested Screw Torque—
10.16 in.-lbs.**

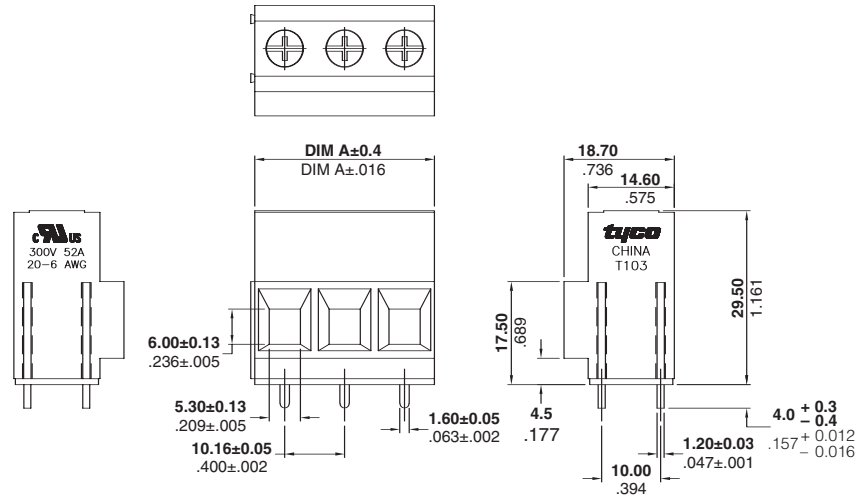

No. of Positions	Dim. A	Part Numbers	
		Green	Black
2	20.32 [.800]	1776886-2	1-1776886-2
3	30.48 [1.200]	1776886-3	1-1776886-3

Note: All part numbers are RoHS Compliant.

Board Mount Multi-Level Stacking

Board Mount w/Interlock, Multi-Level Stacking 16-30 AWG

Product Facts

- One-piece board mount terminal blocks
- Interchangeable with existing products of other terminal block suppliers
- PC board footprint fully compatible with existing Industry Standards: pc board thickness 1.6–2.4 mm
- Modular design with interlocking fixture to assemble higher number of ways applies to 5.0 and 5.08 mm centerlines
- Rising screw clamp design
- Funnel entry housing for easier wire insertion
- Test probe access
- Terminal blocks supplied with open captive screws

Tyco Electronics is expanding the range of board mount terminal blocks with its family of multi-level Terminal Block stacking connectors; three different heights are available to combine one-piece blocks, according to the user's need for better space utilization and easier wire accessibility.

5.0, 5.08, 10.0 and 10.16 mm centerline blocks suitable for 1.5 mm² max. solid wire and 1.0 mm² max. stranded wire are described in the following pages.

Mechanical/Environmental Performance

Operating Temperature—
-40°C up to +105°C

Climate Category—
40/110/21 per IEC 68-1

Level	Height	Level Combinations
1st Level	10.0 mm	1st and 2nd level; 2nd and 3rd level; three levels, 2nd level; 3rd level
2nd Level	19.0 mm	
3rd Level	28.0 mm	

Board Mount w/Interlock, Multi-Level Stacking 12-30 AWG

5.0, 5.08, 10.0 and 10.16 mm centerline blocks suitable for 4.0 mm² max. solid wire and 2.5 mm² max. stranded wire are described in the following pages.

Mechanical/Environmental Performance

Operating Temperature—
-40°C up to +105°C

Climate Category—
40/110/21 per IEC 68-1

Level	Height
1st Level	18.6 mm
2nd Level	31.5 mm
3rd Level	45.0 mm

Centerline	No. of Pos.	Level Combinations
5.00 mm	2–3	1st and 2nd level; 2nd and 3rd level; three levels, 2nd level; 3rd level
5.08 mm	2–3	1st and 2nd level; 2nd and 3rd level; three levels, 2nd level; 3rd level
10.00 mm	2	1st and 2nd level; 2nd and 3rd level; three levels, 2nd level; 3rd level
10.16 mm	2	1st and 2nd level; 2nd and 3rd level; three levels, 2nd level; 3rd level

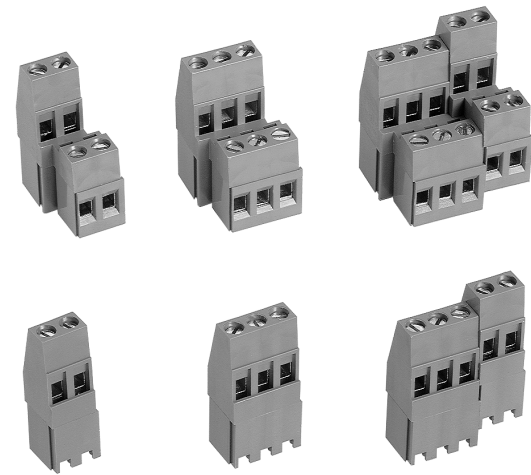

Note: All part numbers are RoHS Compliant.

Board Mount, 1st and 2nd Level Stacking Connectors

Board Mount w/Interlock, 5.0 mm Centerline, 1st and 2nd Level, Stacking Color – Green

**UL Rating – 300 V, 13.5 A
16-30 AWG
10 A for field wiring applications**

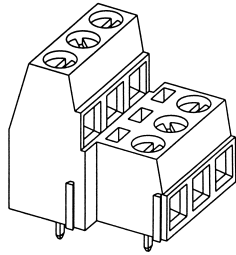

Suggested Screw Torque—
6.0 in.-lb.

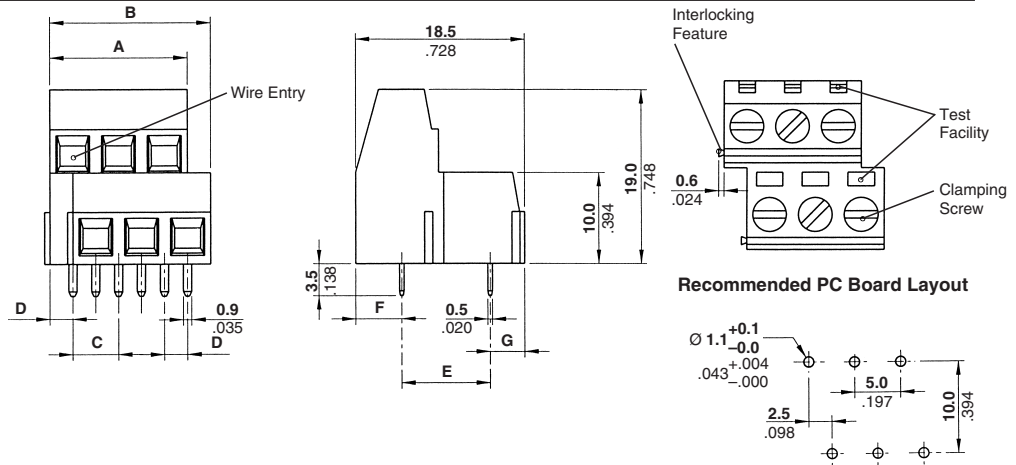

No. of Positions	Dimensions							Part Numbers
	A	B	C	D	E	F	G	
2	10.0 .394	12.5 .492	5.0 .197	2.5 .098	10.0 .394	4.4 .173	4.1 .161	282868-2
3	15.0 .591	17.5 .689	5.0 .197	2.5 .098	10.0 .394	4.4 .173	4.1 .161	282868-3

Board Mount w/Interlock, 5.0 mm Centerline, 1st and 2nd Level, Stacking

**UL Rating – 300 V, 17.5 A
12-30 AWG
15 A for field wiring applications**

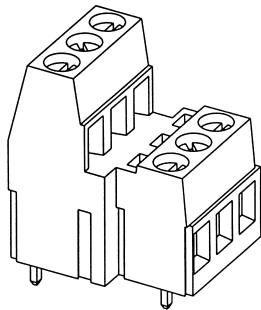

Suggested Screw Torque—
7.0 in.-lb.

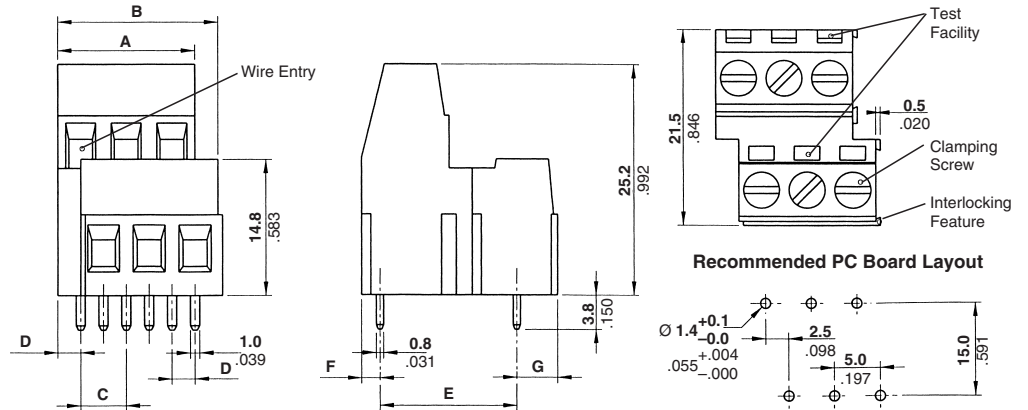

No. of Positions	Dimensions							Part Numbers	
	A	B	C	D	E	F	G	Green	Blue
2	10.0 .394	12.5 .492	5.0 .197	2.5 .098	15.0 .591	2.0 .079	4.5 .177	282888-2	796691-2
3	15.0 .591	17.5 .689	5.0 .197	2.5 .098	15.0 .591	2.0 .079	4.5 .177	282888-3	796691-3
4	20.0 .787	22.5 .886	5.0 .197	2.5 .098	15.0 .591	2.0 .079	4.5 .177	—	796691-4
5	25.0 .984	27.5 1.083	5.0 .197	2.5 .098	15.0 .591	2.0 .079	4.5 .177	—	796691-5
6	30.0 1.181	32.5 1.28	5.0 .197	2.5 .098	15.0 .591	2.0 .079	4.5 .177	—	796691-6
7	35.0 1.378	37.5 1.476	5.0 .197	2.5 .098	15.0 .591	2.0 .079	4.5 .177	—	796691-7
8	40.0 1.575	42.5 1.673	5.0 .197	2.5 .098	15.0 .591	2.0 .079	4.5 .177	—	796691-8
9	45.0 1.772	47.5 1.87	5.0 .197	2.5 .098	15.0 .591	2.0 .079	4.5 .177	—	796691-9
10	50.0 1.968	52.5 2.067	5.0 .197	2.5 .098	15.0 .591	2.0 .079	4.5 .177	—	1-796691-0
11	55.0 2.165	57.5 2.264	5.0 .197	2.5 .098	15.0 .591	2.0 .079	4.5 .177	—	1-796691-1
12	60.0 2.362	62.5 2.461	5.0 .197	2.5 .098	15.0 .591	2.0 .079	4.5 .177	—	1-796691-2

Note: BUCHANAN Terminal Block Series B07C4VxxT has been superceded/replaced with 796691-xx (blue). RDI Terminal Block Series 5LEEV-xx has been superceded/replaced with 796691-xx.

Note: All part numbers are RoHS Compliant.

Board Mount, 1st and 2nd Level Stacking Connectors (Continued)

Board Mount w/Interlock, 5.08 mm Centerline, 1st and 2nd Level, Stacking Color – Green

**UL Rating – 300 V, 13.5 A
16-30 AWG
10 A for field wiring applications**

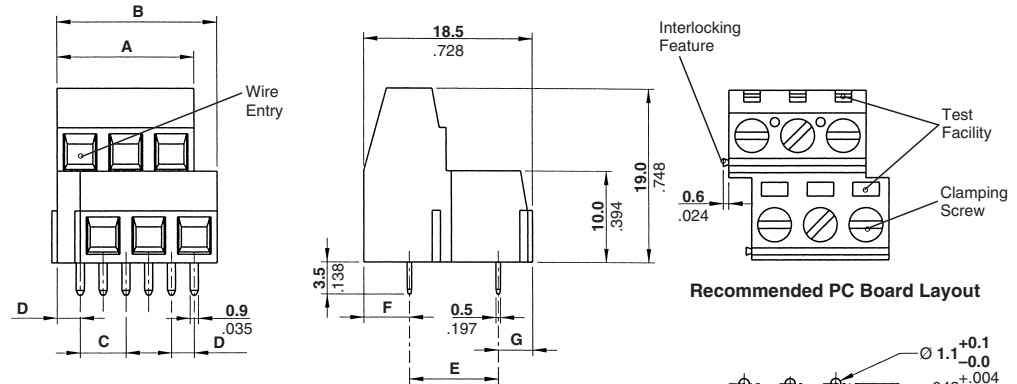
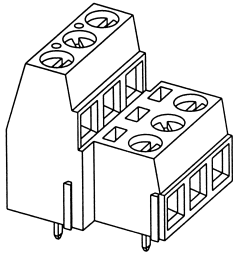

Recommended PC Board Layout

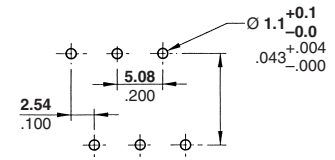

Suggested Screw Torque—
6.0 in.-lb.

No. of Positions	Dimensions							Part Numbers
	A	B	C	D	E	F	G	
2	10.16 .400	12.70 .500	5.08 .200	2.54 .100	10.16 .400	4.24 .167	4.1 .161	282869-2
3	15.24 .600	17.78 .700	5.08 .200	2.54 .100	10.16 .400	4.24 .167	4.1 .161	282869-3

Board Mount w/Interlock, 5.08 mm Centerline, 1st and 2nd Level, Stacking

**UL Rating – 300 V, 17.5 A
12-30 AWG
15 A for field wiring applications**

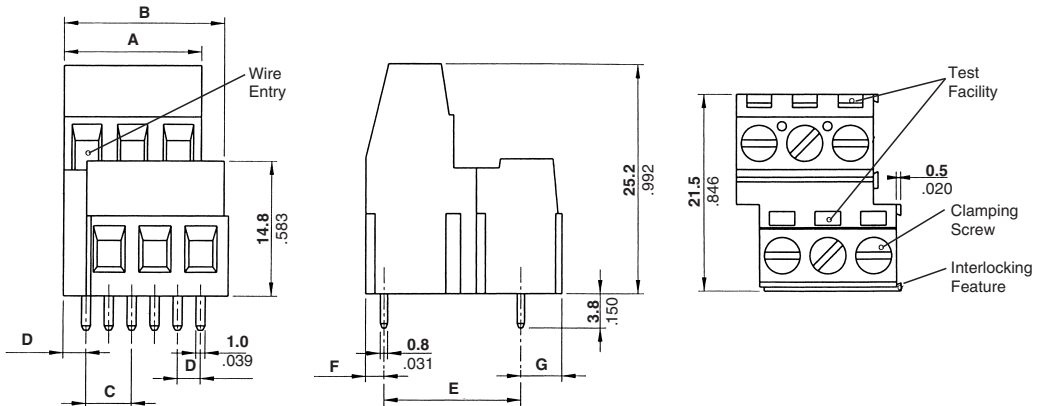
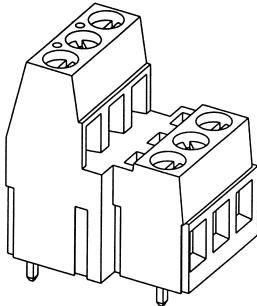

No. of Positions	Dimensions							Part Numbers		
	A	B	C	D	E	F	G	Gray	Green	Black
2	10.16 .400	12.70 .500	5.08 .200	2.54 .100	15.24 .600	1.76 .069	4.5 .177	1546222-2	796692-2	796984-2
3	15.24 .600	17.78 .700	5.08 .200	2.54 .100	15.24 .600	1.76 .069	4.5 .177	1546222-3	796692-3	796984-3
4	20.32 0.80	22.86 0.90	5.08 .200	2.54 .100	15.24 .600	1.76 .069	4.5 .177	—	796692-4	796984-4
5	25.40 1.00	27.94 1.10	5.08 .200	2.54 .100	15.24 .600	1.76 .069	4.5 .177	—	796692-5	796984-5
6	30.48 1.20	33.02 1.30	5.08 .200	2.54 .100	15.24 .600	1.76 .069	4.5 .177	—	796692-6	796984-6
7	35.56 1.40	38.10 1.50	5.08 .200	2.54 .100	15.24 .600	1.76 .069	4.5 .177	—	796692-7	796984-7
8	40.64 1.60	43.18 1.70	5.08 .200	2.54 .100	15.24 .600	1.76 .069	4.5 .177	—	796692-8	796984-8
9	45.72 1.80	48.26 1.90	5.08 .200	2.54 .100	15.24 .600	1.76 .069	4.5 .177	—	796692-9	796984-9
10	50.80 2.00	53.34 2.10	5.08 .200	2.54 .100	15.24 .600	1.76 .069	4.5 .177	—	1-796692-0	1-796984-0
11	55.88 2.20	58.42 2.30	5.08 .200	2.54 .100	15.24 .600	1.76 .069	4.5 .177	—	1-796692-1	1-796984-1
12	60.96 2.40	63.50 2.50	5.08 .200	2.54 .100	15.24 .600	1.76 .069	4.5 .177	—	1-796692-2	1-796984-2

Suggested Screw Torque—
7.0 in.-lb.

Recommended PC Board Layout

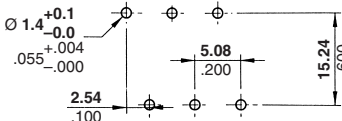

Note: RDI Terminal Block Series 2LEEV-xx/2 has been superceded/replaced with 796692-xx (green).



Note: All part numbers are RoHS Compliant.

Board Mount, 1st and 2nd Level Stacking Connectors (Continued)

Board Mount w/Interlock, 5.08 mm Centerline, 1st and 2nd Level, Stacking Color – Green

**UL Rating – 300 V, 24 A
12-30 AWG
20 A for field wiring applications**

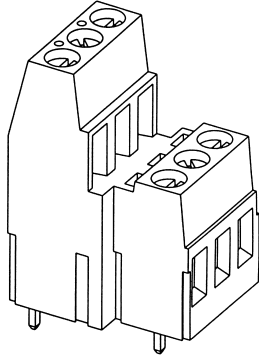

Suggested Screw Torque—
7.0 in.-lb.

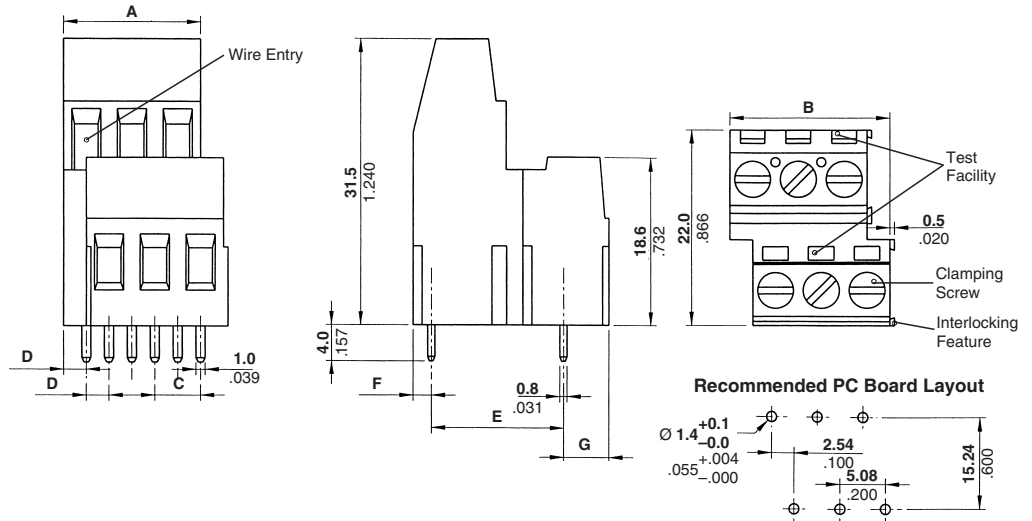

No. of Positions	Dimensions							Part Numbers
	A	B	C	D	E	F	G	
2	10.16 .400	12.70 .500	5.08 .200	2.54 .100	15.24 .600	1.76 .069	5.0 .197	282909-2
3	15.24 .600	17.78 .700	5.08 .200	2.54 .100	15.24 .600	1.76 .069	5.0 .197	282909-3

Board Mount, 2nd and 3rd Level Stacking Connectors

Board Mount w/Interlock, 5.08 mm Centerline, 2nd and 3rd Level, Stacking Color – Green

**UL Rating – 300 V, 13.5 A
16-30 AWG
10 A for field wiring applications**

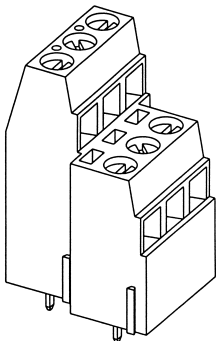

Suggested Screw Torque—
6.0 in.-lb.

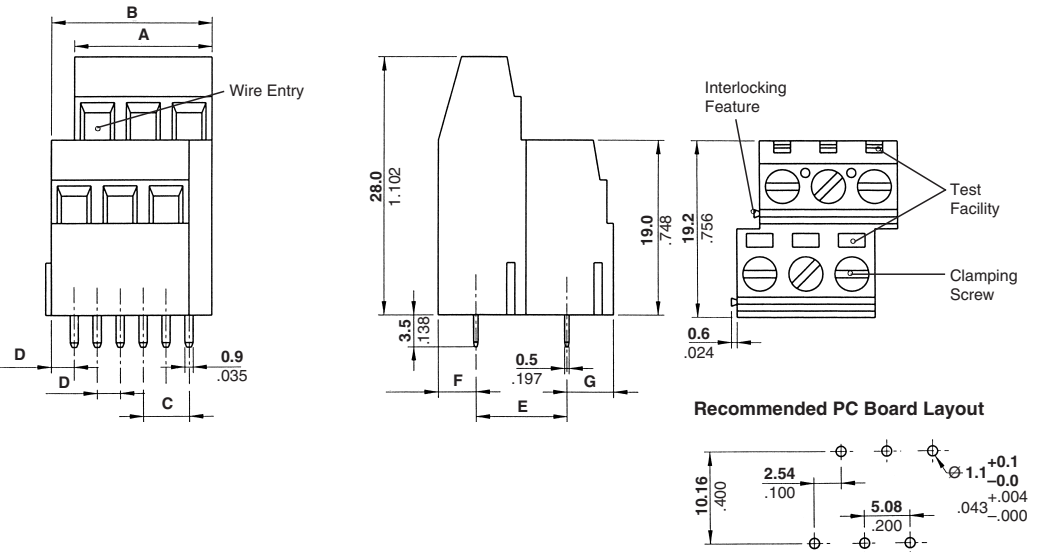

No. of Positions	Dimensions							Part Numbers
	A	B	C	D	E	F	G	
2	10.16 .400	12.70 .500	5.08 .200	2.54 .100	10.16 .400	3.78 .149	5.26 .207	282873-2
3	15.24 .600	17.78 .700	5.08 .200	2.54 .100	10.16 .400	3.78 .149	5.26 .207	282873-3

Note: All part numbers are RoHS Compliant.

Board Mount, 2nd and 3rd Level Stacking Connectors (Continued)

Board Mount w/Interlock, 5.08 mm Centerline, 2nd and 3rd Level, Stacking Color – Green

**UL Rating – 300 V, 24 A
12-30 AWG
20 A for field wiring applications**

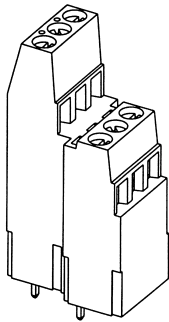

Suggested Screw Torque—
7.0 in.-lb.

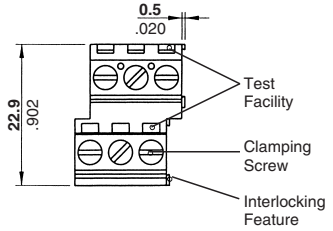
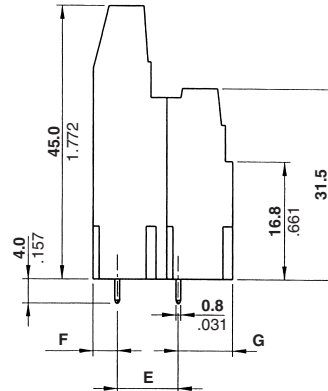
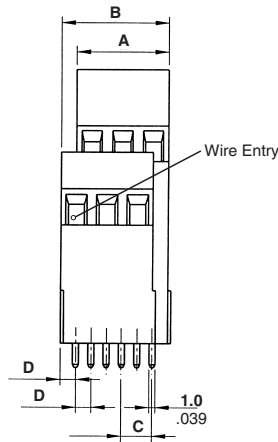

Recommended PC Board Layout

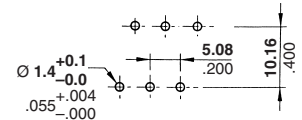

No. of Positions	Dimensions							Part Numbers
	A	B	C	D	E	F	G	
2	10.16 .400	12.70 .500	5.08 .200	2.54 .100	10.16 .400	3.6 .142	9.14 .360	282913-2
3	15.24 .600	17.78 .700	5.08 .200	2.54 .100	10.16 .400	3.6 .142	9.14 .360	282913-3

Board Mount, Three-Levels Stacking Connectors

Board Mount w/Interlock, 5.0 mm Centerline, Three Levels, Stacking Color – Green

**UL Rating – 300 V, 13.5 A
16-30 AWG
10 A for field wiring applications**

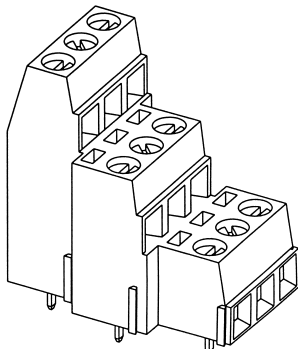

Suggested Screw Torque—
6.0 in.-lb.

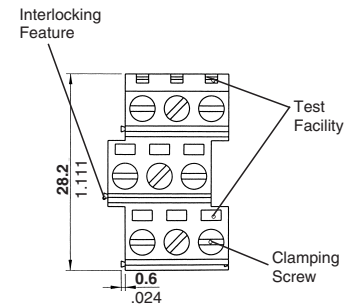
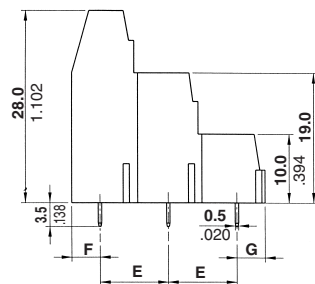
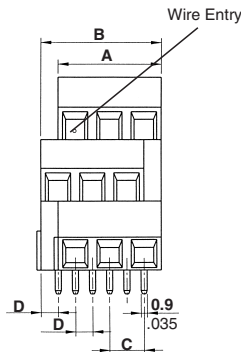

Recommended PC Board Layout

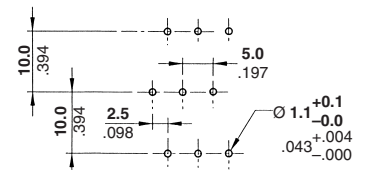

No. of Positions	Dimensions							Part Numbers
	A	B	C	D	E	F	G	
2	10.0 .394	12.5 .492	5.0 .197	2.5 .098	10.0 .394	4.1 .161	4.1 .161	282876-2
3	15.0 .591	17.5 .689	5.0 .197	2.5 .098	10.0 .394	4.1 .161	4.1 .161	282876-3

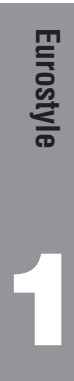

Note: All part numbers are RoHS Compliant.

Board Mount, Three-Levels Stacking Connectors

Board Mount w/Interlock
5.0 mm Centerline,
Three Levels, Stacking
Color – Green
UL Rating – 300 V, 24 A
12-30 AWG
20 A for field wiring applications

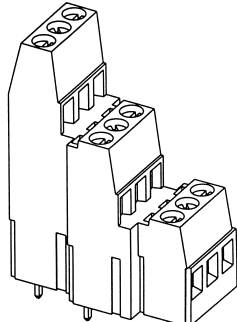

Suggested Screw Torque—
 7.0 in.-lb.

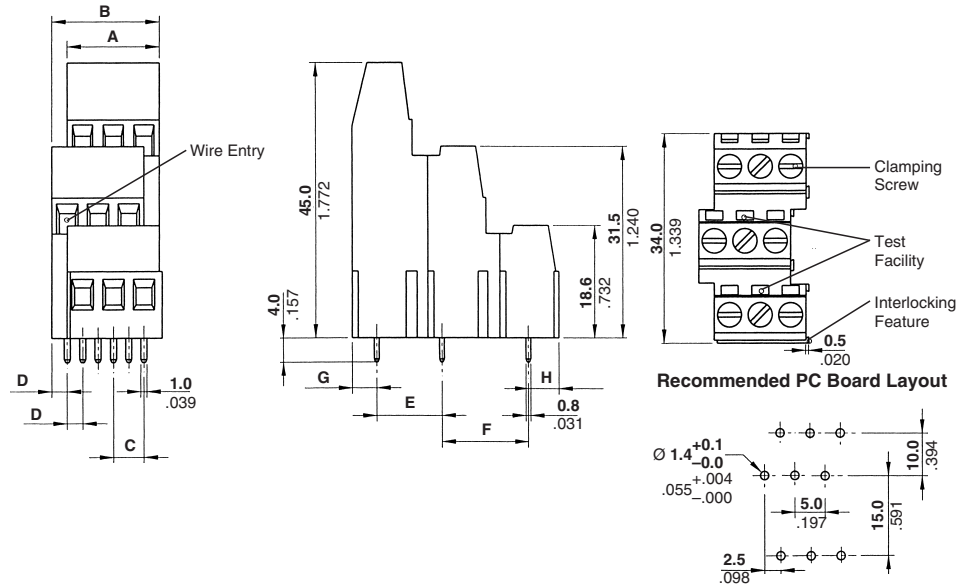

No. of Positions	Dimensions								Part Numbers
	A	B	C	D	E	F	G	H	
2	10.0 .394	12.5 .492	5.0 .197	2.5 .098	10.0 .394	15.0 .591	4.0 .157	5.0 .197	282916-2
3	15.0 .591	17.5 .689	5.0 .197	2.5 .098	10.0 .394	15.0 .591	4.0 .157	5.0 .197	282916-3

Board Mount w/Interlock
5.08 mm Centerline,
Three Levels, Stacking
Color – Green
UL Rating – 300 V, 13.5 A
16-30 AWG
10 A for field wiring applications

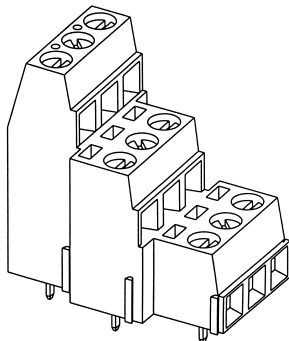

Suggested Screw Torque—
 6.0 in.-lb.

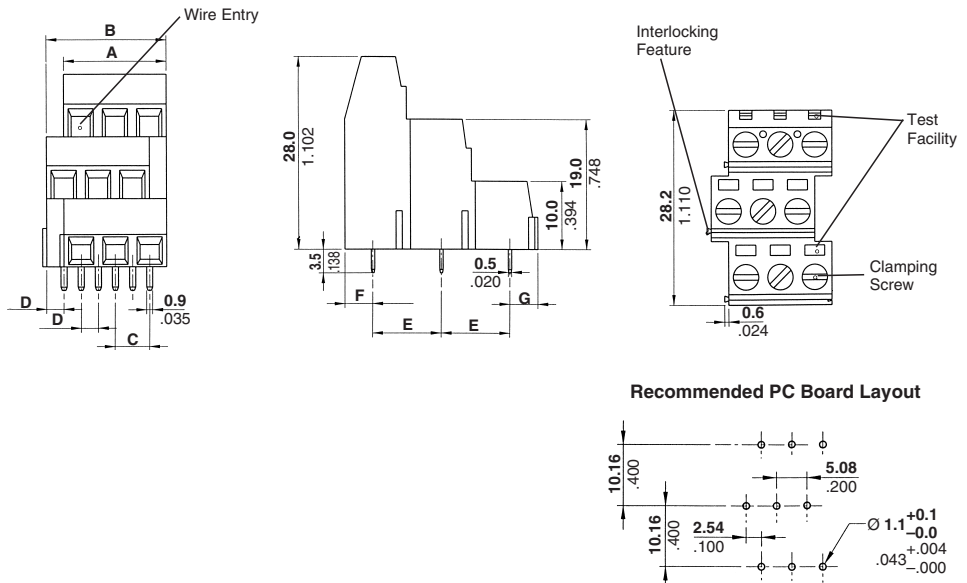

No. of Positions	Dimensions							Part Number
	A	B	C	D	E	F	G	
2	10.16 .400	12.70 .500	5.08 .200	2.54 .100	10.16 .400	3.78 .149	4.1 .161	282877-2
3	15.24 .600	17.78 .700	5.08 .200	2.54 .100	10.16 .400	3.78 .149	4.1 .161	282877-3

Note: All part numbers are RoHS Compliant.

Board Mount, Three-Levels Stacking Connectors (Continued)

**Board Mount w/Interlock
5.08 mm Centerline,
Three Levels, Stacking**
**UL Rating – 300 V, 17.5 A
12-30 AWG
15 A for field wiring applications**

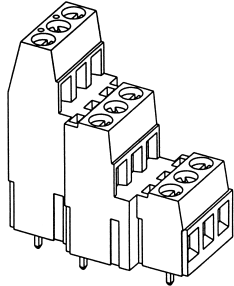

Suggested Screw Torque—
7.0 in.-lb.

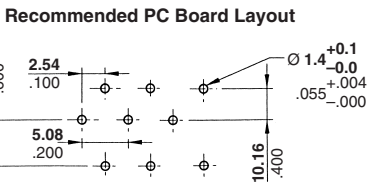
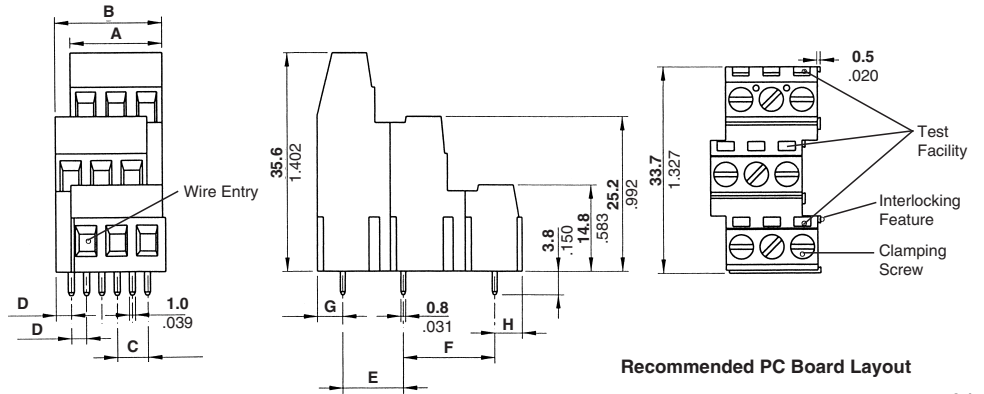

No. of Positions	Dimensions								Part Numbers	
	A	B	C	D	E	F	G	H	Green	Black
2	10.16	12.70	5.08	2.54	10.16	15.24	3.8	4.5	282897-2	1546233-2
	.400	.500	.200	.100	.400	.600	.150	.177		
3	15.24	17.78	5.08	2.54	10.16	15.24	3.8	4.5	282897-3	1546233-3
	.600	.700	.200	.100	.400	.600	.150	.177		

**Board Mount w/Interlock
5.08 mm Centerline,
Three Levels, Stacking
Color – Green**
**UL Rating – 300 V, 24 A
12-30 AWG
20 A for field wiring applications**

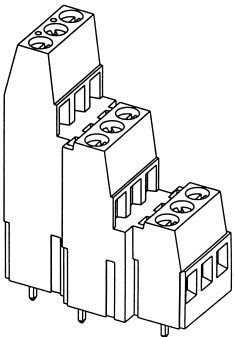

Suggested Screw Torque—
7.0 in.-lb.

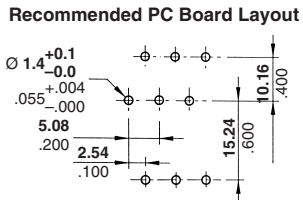
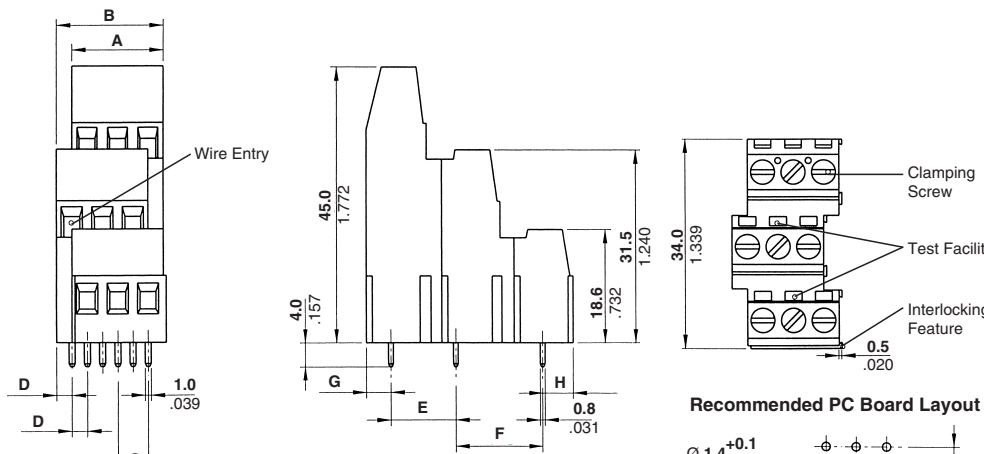

No. of Positions	Dimensions								Part Numbers
	A	B	C	D	E	F	G	H	
2	10.16	12.70	5.08	2.54	10.16	15.24	3.6	5.0	282917-2
	.400	.500	.200	.100	.400	.600	.142	.197	
3	15.24	17.78	5.08	2.54	10.16	15.24	3.6	5.0	282917-3
	.600	.700	.200	.100	.400	.600	.142	.197	

Note: All part numbers are RoHS Compliant.

Board Mount, 2nd Level Stacking Connectors

Board Mount w/Interlock
5.0 mm Centerline,
2nd Level, Stacking
Color – Green
UL Rating – 300 V, 13.5 A
16-30 AWG
10 A for field wiring applications

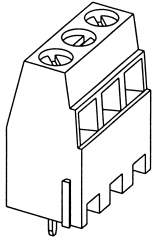

Suggested Screw Torque—
 6.0 in.-lb.

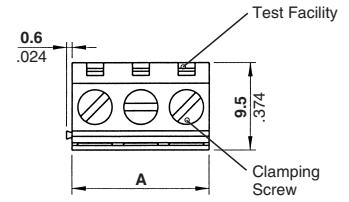
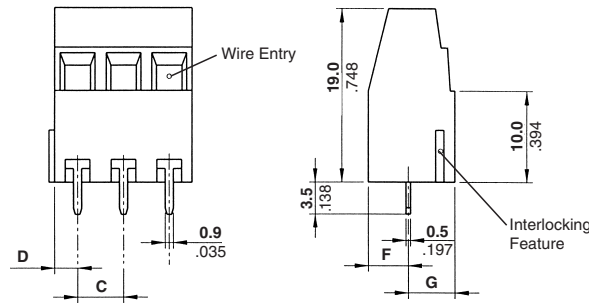

Recommended PC Board Layout

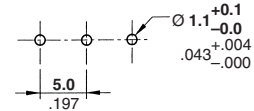

No. of Positions	Dimensions					Part Numbers
	A	C	D	F	G	
2	10.0 .394	5.0 .197	2.5 .098	4.4 .173	5.1 .201	282880-2
3	15.0 .591	5.0 .197	2.5 .098	4.4 .173	5.1 .201	282880-3

Board Mount w/Interlock
5.0 mm Centerline,
2nd Level, Stacking
Color – Green
UL Rating – 300 V, 17.5 A
12-30 AWG
15 A for field wiring applications

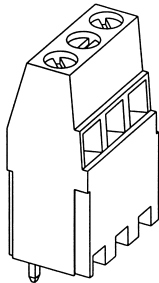

Suggested Screw Torque—
 7.0 in.-lb.

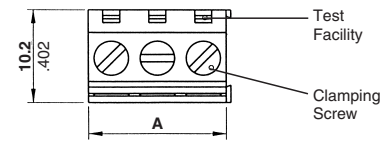
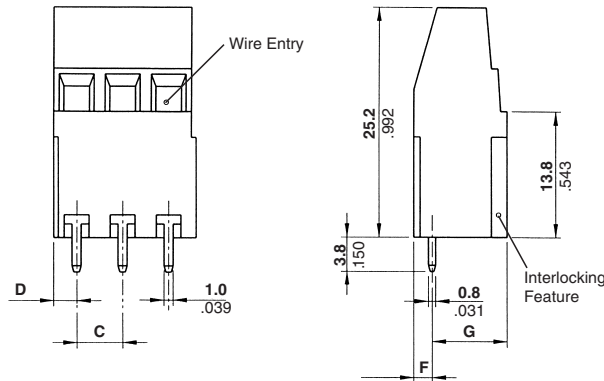

Recommended PC Board Layout

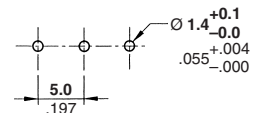

No. of Positions	Dimensions					Part Numbers
	A	C	D	F	G	
2	10.0 .394	5.0 .197	2.5 .098	2.0 .079	8.2 .323	282900-2
3	15.0 .591	5.0 .197	2.5 .098	2.0 .079	8.2 .323	282900-3

Note: All part numbers are RoHS Compliant.

Board Mount, 2nd Level Stacking Connectors (Continued)

Board Mount w/Interlock
5.0 mm Centerline,
2nd Level, Stacking
Color – Green
UL Rating – 300 V, 24 A
12-30 AWG
20 A for field wiring applications

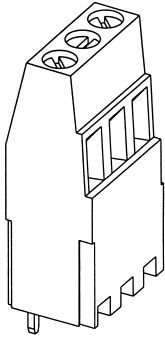

Suggested Screw Torque—
 7.0 in.-lb.

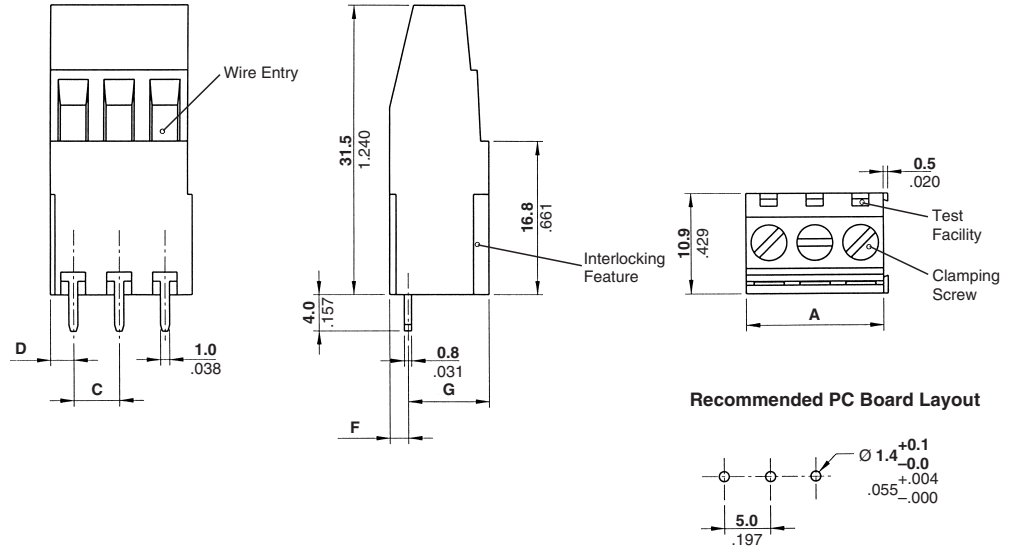

No. of Positions	Dimensions					Part Numbers
	A	C	D	F	G	
2	10.0 .394	5.0 .197	2.5 .098	2.0 .079	8.9 .350	282920-2
3	15.0 .591	5.0 .197	2.5 .098	2.0 .079	8.9 .350	282920-3

Board Mount w/Interlock
5.08 mm Centerline,
2nd Level, Stacking
Color – Green
UL Rating – 300 V, 13.5 A
16-30 AWG
10 A for field wiring applications

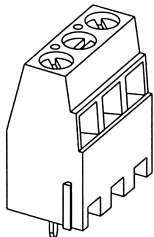

Suggested Screw Torque—
 6.0 in.-lb.

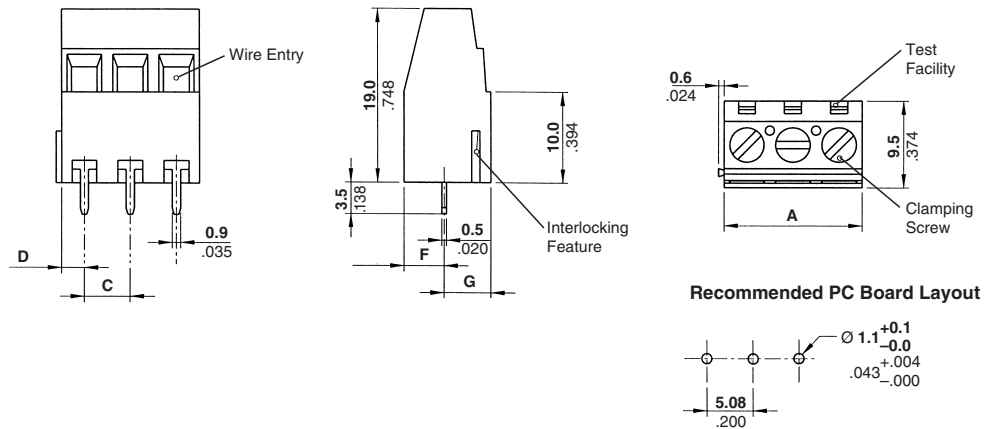

No. of Positions	Dimensions					Part Numbers
	A	C	D	F	G	
2	10.16 .400	5.08 .200	2.54 .100	4.24 .167	5.26 .207	282881-2
3	15.24 .600	5.08 .200	2.54 .100	4.24 .167	5.26 .207	282881-3



Note: All part numbers are RoHS Compliant.

Board Mount, 2nd Level Stacking Connectors (Continued)

Board Mount w/Interlock
5.08 mm Centerline,
2nd Level, Stacking
Color – Green
UL Rating – 300 V, 17.5 A
12-30 AWG
15 A for field wiring applications

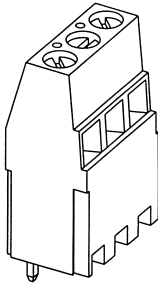

Suggested Screw Torque—
 7.0 in.-lb.

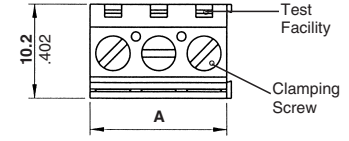
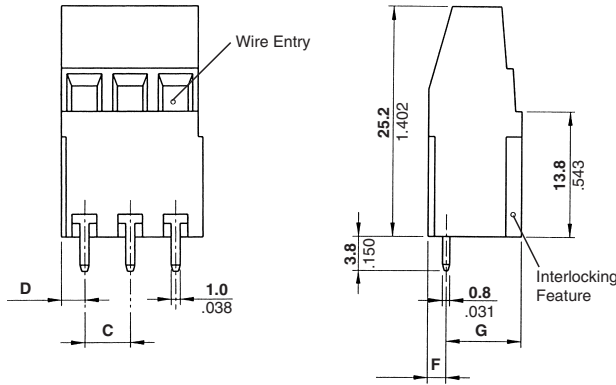

Recommended PC Board Layout

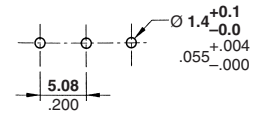

No. of Positions	Dimensions					Part Numbers
	A	C	D	F	G	
2	10.16 .400	5.08 .200	2.54 .100	1.76 .069	8.44 .332	282901-2
3	15.24 .600	5.08 .200	2.54 .100	1.76 .069	8.44 .332	282901-3

Board Mount w/Interlock
5.08 mm Centerline,
2nd Level, Stacking
Color – Green
UL Rating – 300 V, 24 A
12-30 AWG
20 A for field wiring applications

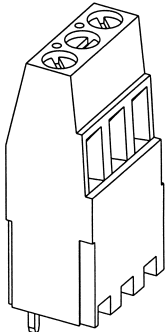

Suggested Screw Torque—
 7.0 in.-lb.

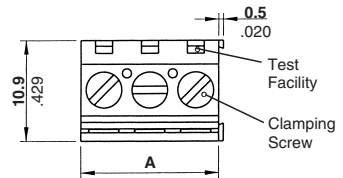
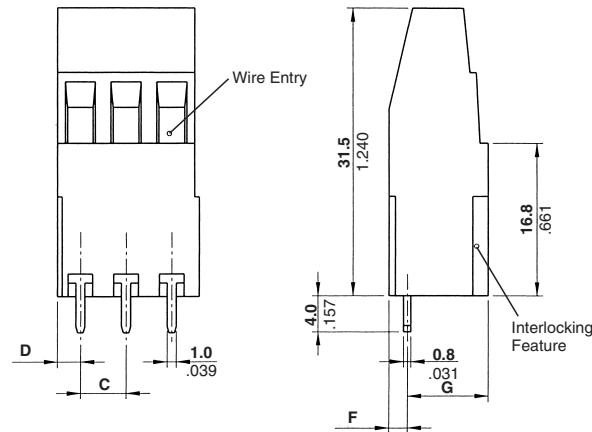

Recommended PC Board Layout

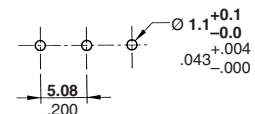

No. of Positions	Dimensions					Part Numbers
	A	C	D	F	G	
2	10.16 .400	5.08 .200	2.54 .100	1.76 .069	9.14 .360	282921-2
3	15.24 .600	5.08 .200	2.54 .100	1.76 .069	9.14 .360	282921-3

Note: All part numbers are RoHS Compliant.

Board Mount, 3rd Level Stacking Connectors

Board Mount w/Interlock
5.0 mm Centerline,
3rd Level, Stacking
Color – Green
UL Rating – 300 V, 13.5 A
16-30 AWG
10 A for field wiring applications

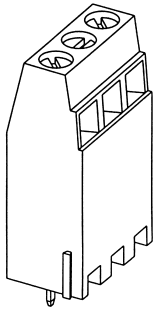

Suggested Screw Torque—
 6.0 in.-lb.

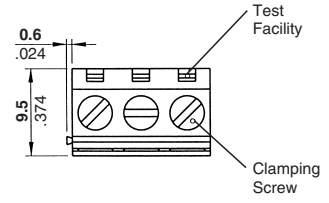
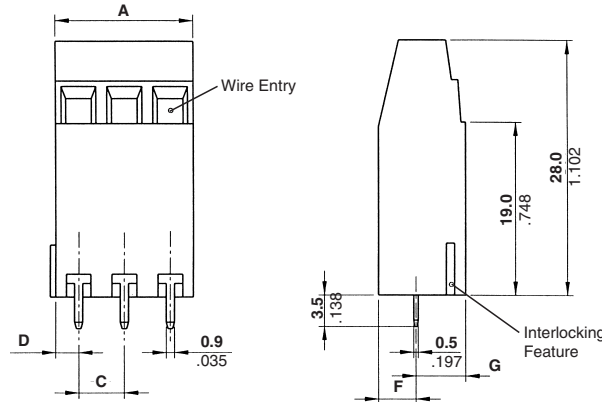

Recommended PC Board Layout

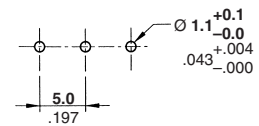

No. of Positions	Dimensions					Part Numbers
	A	C	D	F	G	
2	10.0 .394	5.0 .197	2.5 .098	4.1 .173	5.4 .213	282884-2
3	15.0 .591	5.0 .197	2.5 .098	4.1 .173	5.4 .213	282884-3

Board Mount w/Interlock
5.0 mm Centerline,
3rd Level, Stacking
Color – Green
UL Rating – 300 V, 24 A
12-30 AWG
20 A for field wiring applications

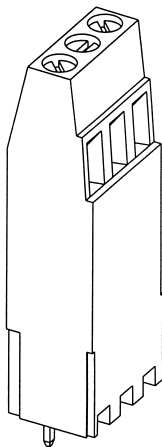

Suggested Screw Torque—
 7.0 in.-lb.

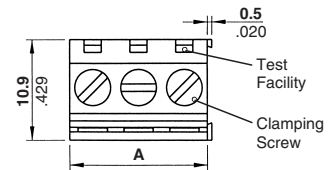
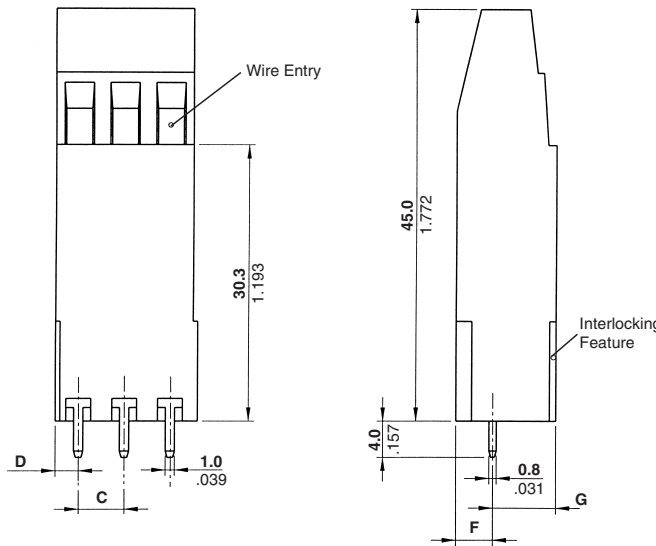

Recommended PC Board Layout

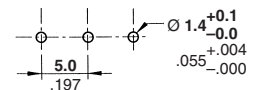

No. of Positions	Dimensions					Part Numbers
	A	C	D	F	G	
2	10.0 .394	5.0 .197	2.5 .098	4.0 .157	6.9 .272	282924-2
3	15.0 .591	5.0 .197	2.5 .098	4.0 .157	6.9 .272	282924-3

Note: All part numbers are RoHS Compliant.

Board Mount, 3rd Level Stacking Connectors (Continued)

Board Mount w/Interlock
5.08 mm Centerline,
3rd Level, Stacking
Color – Green

UL Rating – 300 V, 17.5 A
12-30 AWG
15 A for field wiring applications

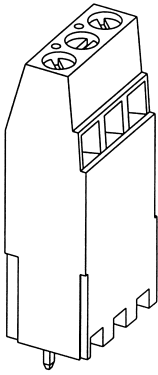

Suggested Screw Torque—
 7.0 in.-lb.

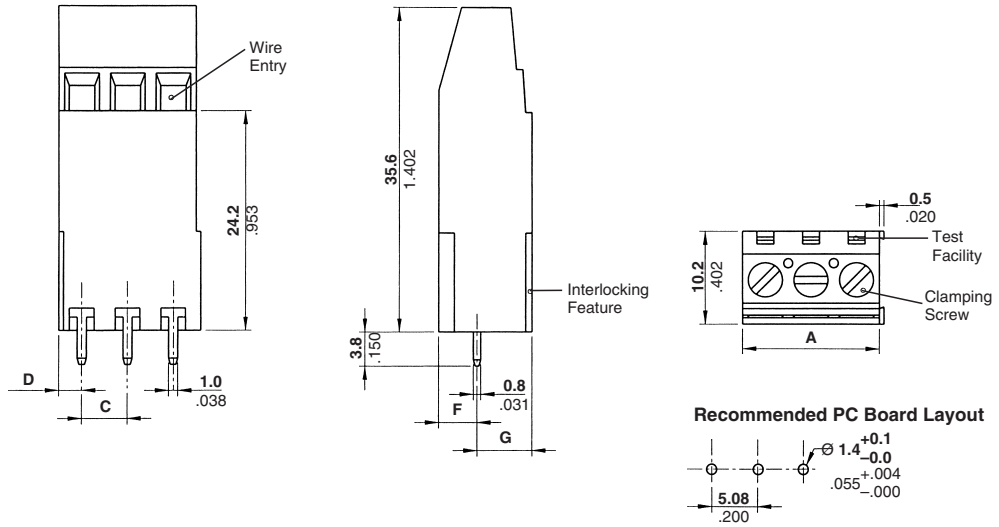

No. of Positions	Dimensions					Part Numbers
	A	C	D	F	G	
2	10.16 .400	5.08 .200	2.54 .100	3.8 .150	6.4 .252	282905-2
3	15.24 .600	5.08 .200	2.54 .100	3.8 .150	6.4 .252	282905-3

Board Mount w/Interlock
5.08 mm Centerline,
3rd Level, Stacking
Color – Green

UL Rating – 300 V, 24 A
12-30 AWG
20 A for field wiring applications

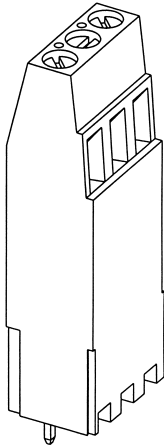

Suggested Screw Torque—
 7.0 in.-lb.

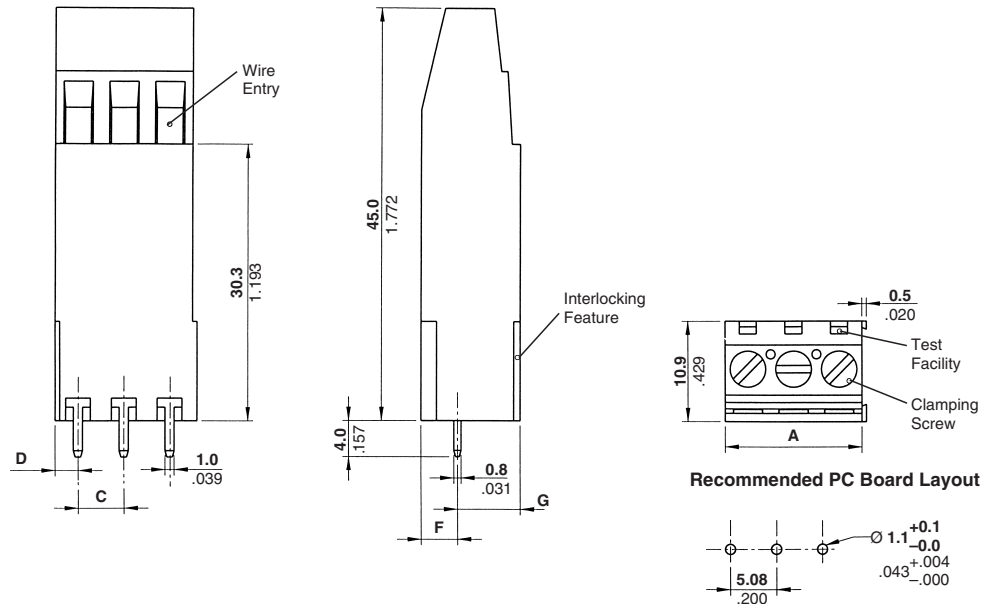

No. of Positions	Dimensions					Part Number
	A	C	D	F	G	
2	10.16 .400	5.08 .200	2.54 .100	3.6 .142	7.3 .287	282925-2
3	15.24 .600	5.08 .200	2.54 .100	3.6 .142	7.3 .287	282925-3

Note: All part numbers are RoHS Compliant.

Board Mount, 3rd Level Stacking Connectors (Continued)

Board Mount w/Interlock
10.0 mm Centerline,
3rd Level, Stacking
Color – Green

UL Rating – 600 V, 17.5 A
16-30 AWG
15 A for field wiring applications

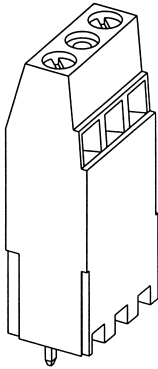

Suggested Screw Torque—
 7.0 in.-lb.

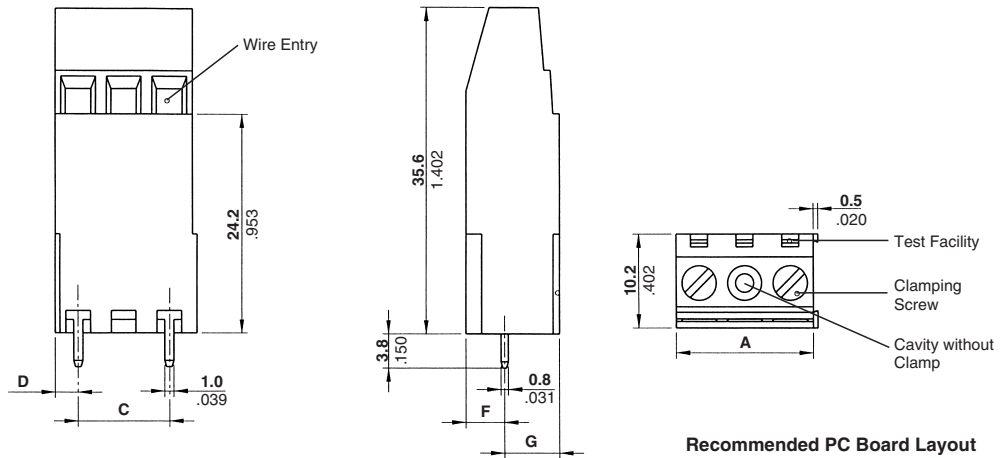

No. of Positions	Dimensions					Part Number
	A	C	D	F	G	
2	15.0 .591	10.0 .394	2.5 .098	4.2 .165	6.0 .236	282906-2



Two-Piece Terminal Block Connectors

Two-Piece Terminal Block Connectors

Tyco Electronics currently provides a full range of two-piece modular terminal blocks for headers with 3.5, 3.81, 5.0, 5.08, 7.5, 7.62, 10.0 and 10.16 mm centerline.

Product Facts

- n 3.5, 3.81, 5.0, 5.08, 7.5, 7.62, 10.0 and 10.16 mm centerlines
- n Straight and right-angle shrouded headers with open or closed ends
- n Double-sided female contact design
- n Built-in interlocks to assemble higher number of ways
- n Retention latches between plug and header
- n Polarization keys for easier mating
- n Special 90°/180° and 90°/270° Plugs and Unshrouded Headers (5.0 and 10.0mm Centerline)
- n Interchangeable with existing products of most terminal block suppliers
- n PC board footprint fully compatible with existing Industry Standards: pc board thickness 1.6–2.4 mm
- n 2-3-4 way modules with interlocking fixture, 3.5, 3.81, 5.0 and 5.08 mm centerline, to assemble higher number of ways
- n Polarizing keys promote proper mating (see page 108 for keys and page 107 for labeling)
- n Straight and right-angle headers
- n Stackable open end headers
- n Closed end headers
- n Retention latch between plug and header housings
- n Rising cage clamp design
- n Double-sided contact spring
- n Funnel entry plug housing for easier wire insertion
- n Captive screw
- n Plugs supplied with open screw

- n **Screw flange versions available on 3.5, 3.81, 5.0, and 5.08 mm centerlines**
- n **5.0 and 10.0 mm centerlines**
- n **Recognized under the Component Program of Underwriters Laboratories Inc., File No. E60677** 
- n **Certified by Canadian Standards Association, File No. 703157** 
- n **Interchangeable with most existing products**
- n **PC board footprint compatible with the existing Industry Standards**
- n **Rising cage clamp design**
- n **Funnel entry housing for easier wire insertion**
- n **Test probe access**
- n **Terminal blocks supplied with open captive screws**
- n **Adhesive labeling for numbering**

Housing Material—Polyamide 6/6, UL 94V-0 rated

Male Contact—Brass, tin plated

Female Contact—Phosphor bronze, tin plated

Screw Clamp—Brass, nickel plated

Screw—Brass, nickel plated

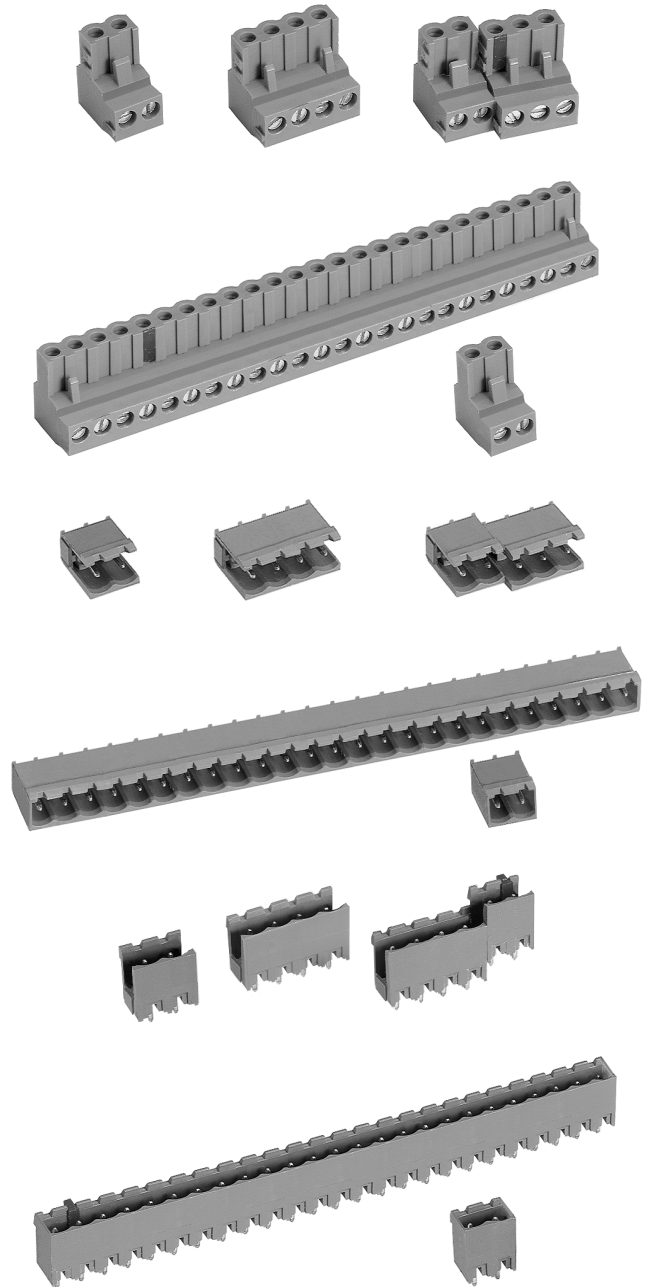

Two-Piece Header and Plug

Centerline	No. of Positions
3.50 [.138]*	2–25
3.81 [.150]*	2–25
5.00 [.197]*	2–25
5.08 [.200]*	2–25
7.50 [.295]	2–12
7.62 [.300]	2–12
10.00 [.394]	2–13
10.16 [.400]	2–13

*Flanged versions may not reflect standard position size.

Note: All part numbers are RoHS Compliant.

Two-Piece Terminal Block Connectors (Continued)

Straight Header w/Threaded Flange, 3.5 mm Centerline
UL Rating – 300 V, 11 A

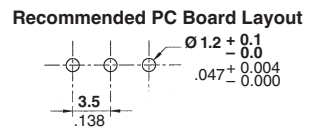
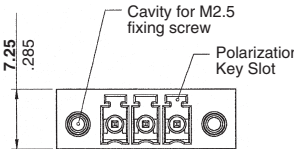
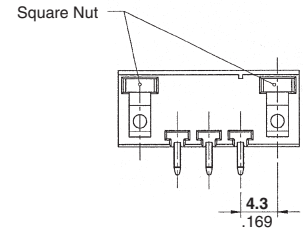
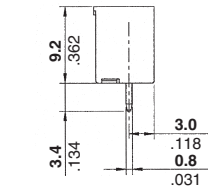
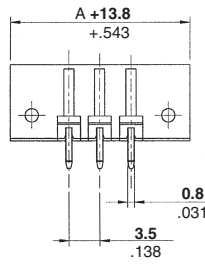
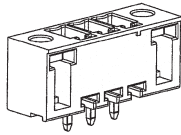

No. of Positions	Dim. A	Part Numbers	
		Green	Black*
2	3.5 [0.138]	284516-2	1776132-2
3	7.0 [0.276]	284516-3	1776132-3
4	10.5 [0.413]	284516-4	1776132-4
5	14.0 [0.551]	284516-5	1776132-5
6	17.5 [0.689]	284516-6	1776132-6
7	21.0 [0.827]	284516-7	1776132-7
8	24.5 [0.965]	284516-8	1776132-8
9	28.0 [1.102]	284516-9	1776132-9
10	31.5 [1.240]	1-284516-0	1-1776132-0
11	35.0 [1.378]	1-284516-1	1-1776132-1
12	38.5 [1.516]	1-284516-2	1-1776132-2

No. of Positions	Dim. A	Part Numbers	
		Green	Black*
13	42.0 [1.654]	1-284516-3	—
14	45.5 [1.791]	1-284516-4	—
15	49.0 [1.929]	1-284516-5	—
16	52.5 [2.067]	1-284516-6	—
17	56.0 [2.205]	1-284516-7	—
18	59.5 [2.343]	1-284516-8	—
19	63.0 [2.480]	1-284516-9	—
20	66.5 [2.618]	2-284516-0	—
21	70.0 [2.756]	2-284516-1	—
22	73.5 [2.894]	2-284516-2	—
23	77.0 [3.031]	2-284516-3	—

*Wave solder process capable to 265°C [509°F] for 10 seconds. Dimensions may vary from what is shown for High Temperature Parts. Please check Customer Drawing.

Straight Header w/Threaded Flange, 3.81 mm Centerline
UL Rating – 300 V, 11 A

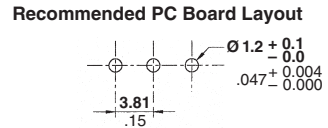
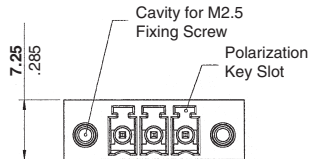
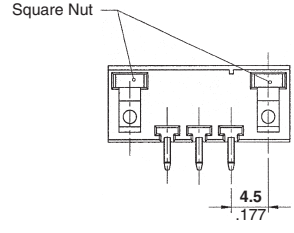
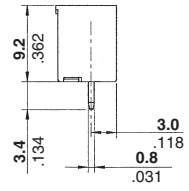
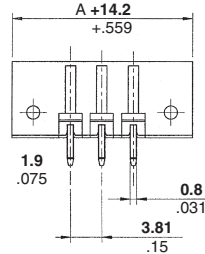
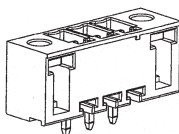

No. of Positions	Dim. A	Part Numbers	
		Green	Black*
2	3.81 [0.15]	284519-2	1776133-2
3	7.62 [0.30]	284519-3	1776133-3
4	11.43 [0.45]	284519-4	1776133-4
5	15.24 [0.60]	284519-5	1776133-5
6	19.05 [0.75]	284519-6	1776133-6
7	22.86 [0.90]	284519-7	1776133-7
8	26.67 [1.05]	284519-8	1776133-8
9	30.48 [1.20]	284519-9	1776133-9
10	34.29 [1.35]	1-284519-0	1-1776133-0
11	38.10 [1.50]	1-284519-1	1-1776133-1
12	41.91 [1.65]	1-284519-2	1-1776133-2

No. of Positions	Dim. A	Part Numbers	
		Green	Black*
13	45.72 [1.80]	1-284519-3	—
14	49.53 [1.95]	1-284519-4	—
15	53.34 [2.10]	1-284519-5	—
16	57.15 [2.25]	1-284519-6	—
17	60.96 [2.40]	1-284519-7	—
18	64.77 [2.55]	1-284519-8	—
19	68.58 [2.70]	1-284519-9	—
20	72.39 [2.85]	2-284519-0	—
21	76.20 [3.00]	2-284519-1	—
22	80.01 [3.15]	2-284519-2	—
23	83.82 [3.30]	2-284519-3	—

*Wave solder process capable to 265°C [509°F] for 10 seconds. Dimensions may vary from what is shown for High Temperature Parts. Please check Customer Drawing.



Two-Piece Terminal Block Connectors (Continued)

**Straight Header w/Locking
Screw Flange,
5.08 mm Centerline,
Color – Green
UL Rating – 300 V, 15 A**

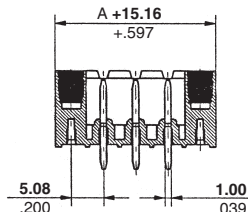
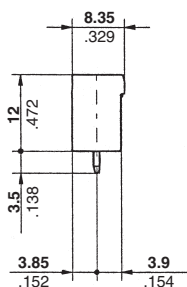

Recommended PC Board Layout



No. of Positions	Dim. A	Part Numbers
2	5.08 [0.20]	796867-2
3	10.16 [0.40]	796867-3
4	15.24 [0.60]	796867-4
5	20.32 [0.80]	796867-5
6	25.40 [1.00]	796867-6
7	30.48 [1.20]	796867-7
8	35.56 [1.40]	796867-8
9	40.64 [1.60]	796867-9
10	45.72 [1.80]	1-796867-0
11	50.80 [2.00]	1-796867-1
12	55.88 [2.20]	1-796867-2

No. of Positions	Dim. A	Part Numbers
13	60.96 [2.40]	1-796867-3
14	66.04 [2.60]	1-796867-4
15	71.12 [2.80]	1-796867-5
16	76.20 [3.00]	1-796867-6
17	81.28 [3.20]	1-796867-7
18	86.36 [3.40]	1-796867-8
19	91.44 [3.60]	1-796867-9
20	96.52 [3.80]	2-796867-0
21	101.60 [4.00]	2-796867-1
22	106.68 [4.20]	2-796867-2
23	111.76 [4.40]	2-796867-3

Note: All part numbers are RoHS Compliant.

Two-Piece Terminal Block Connectors (Continued)

Right-Angle Closed End Header w/Threaded Flange, 3.5 mm Centerline
UL Rating – 300 V, 11 A

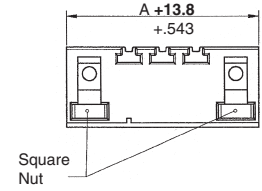
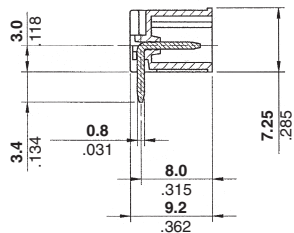
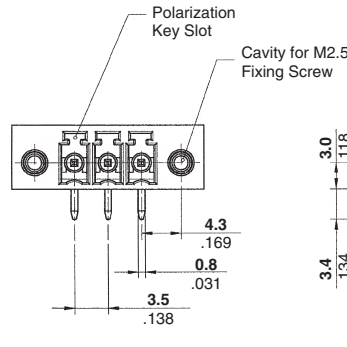
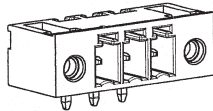

Recommended PC Board Layout

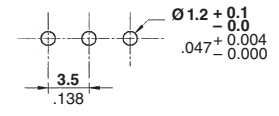

No. of Positions	Dim. A	Part Numbers	
		Green	Black*
2	3.5 [0.138]	284539-2	1776136-2
3	7.0 [0.276]	284539-3	1776136-3
4	10.5 [0.413]	284539-4	1776136-4
5	14.0 [0.551]	284539-5	1776136-5
6	17.5 [0.689]	284539-6	1776136-6
7	21.0 [0.827]	284539-7	1776136-7
8	24.5 [0.965]	284539-8	1776136-8
9	28.0 [1.102]	284539-9	1776136-9
10	31.5 [1.240]	1-284539-0	1-1776136-0
11	35.0 [1.378]	1-284539-1	1-1776136-1
12	38.5 [1.516]	1-284539-2	1-1776136-2

No. of Positions	Dim. A	Part Numbers	
		Green	Black*
13	42.0 [1.654]	1-284539-3	—
14	45.5 [1.791]	1-284539-4	—
15	49.0 [1.929]	1-284539-5	—
16	52.5 [2.067]	1-284539-6	—
17	56.0 [2.205]	1-284539-7	—
18	59.5 [2.343]	1-284539-8	—
19	63.0 [2.480]	1-284539-9	—
20	66.5 [2.618]	2-284539-0	—
21	70.0 [2.756]	2-284539-1	—
22	73.5 [2.894]	2-284539-2	—
23	77.0 [3.031]	2-284539-3	—

*Wave solder process capable to 265°C [509°F] for 10 seconds. Dimensions may vary from what is shown for High Temperature Parts. Please check Customer Drawing.

Right-Angle Closed End Header w/Threaded Flange, 3.81 mm Centerline
UL Rating – 300 V, 11 A

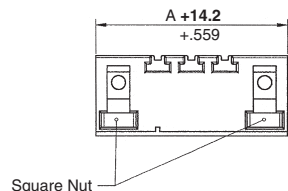
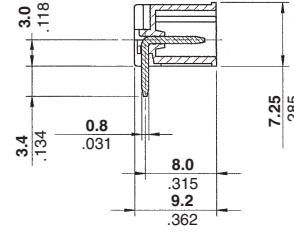
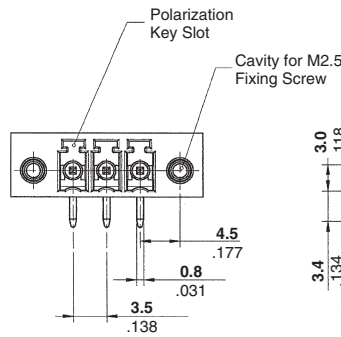
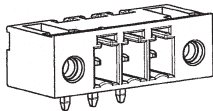

Recommended PC Board Layout

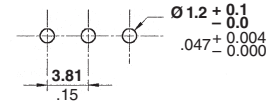

No. of Positions	Dim. A	Part Numbers	
		Green	Black*
2	3.81 [0.15]	284541-2	1776137-2
3	7.62 [0.30]	284541-3	1776137-3
4	11.43 [0.45]	284541-4	1776137-4
5	15.24 [0.60]	284541-5	1776137-5
6	19.05 [0.75]	284541-6	1776137-6
7	22.86 [0.90]	284541-7	1776137-7
8	26.67 [1.05]	284541-8	1776137-8
9	30.48 [1.20]	284541-9	1776137-9
10	34.29 [1.35]	1-284541-0	1-1776137-0
11	38.10 [1.50]	1-284541-1	1-1776137-1
12	41.91 [1.65]	1-284541-2	1-1776137-2

No. of Positions	Dim. A	Part Numbers	
		Green	Black*
13	45.72 [1.80]	1-284541-3	—
14	49.53 [1.95]	1-284541-4	—
15	53.34 [2.10]	1-284541-5	—
16	57.15 [2.25]	1-284541-6	—
17	60.96 [2.40]	1-284541-7	—
18	64.77 [2.55]	1-284541-8	—
19	68.58 [2.70]	1-284541-9	—
20	72.39 [2.85]	2-284541-0	—
21	76.20 [3.00]	2-284541-1	—
22	80.01 [3.15]	2-284541-2	—
23	83.82 [3.30]	2-284541-3	—

*Wave solder process capable to 265°C [509°F] for 10 seconds. Dimensions may vary from what is shown for High Temperature Parts. Please check Customer Drawing.

Note: All part numbers are RoHS Compliant.

Two-Piece Terminal Block Connectors (Continued)

Right-Angle Header w/Locking Screw Flange, 5.0 mm Centerline, Color – Green
UL Rating – 300 V, 15 A

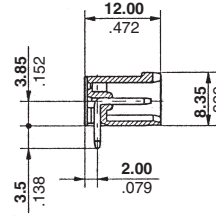
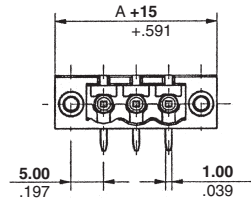
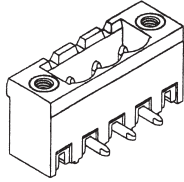

Recommended PC Board Layout

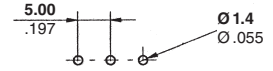

No. of Positions	Dim. A	Part Numbers
2	5.0 [0.197]	796864-2
3	10.0 [0.394]	796864-3
4	15.0 [0.591]	796864-4
5	20.0 [0.787]	796864-5
6	25.0 [0.984]	796864-6
7	30.0 [1.181]	796864-7
8	35.0 [1.378]	796864-8

Right-Angle Header w/Locking Screw Flange, 5.08 mm Centerline, Color – Green
UL Rating – 300 V, 15 A

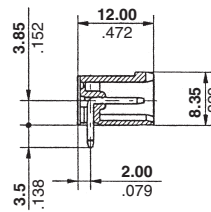
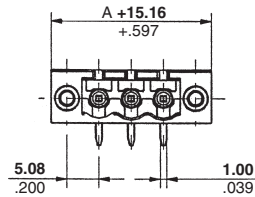
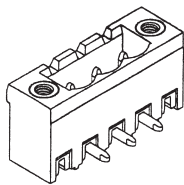

Recommended PC Board Layout

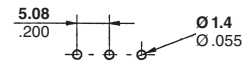

No. of Positions	Dim. A	Part Numbers
2	5.08 [0.20]	796866-2
3	10.16 [0.40]	796866-3
4	15.24 [0.60]	796866-4
5	20.32 [0.80]	796866-5
6	25.40 [1.00]	796866-6
7	30.48 [1.20]	796866-7
8	35.56 [1.40]	796866-8
9	40.64 [1.60]	796866-9
10	45.72 [1.80]	1-796866-0
11	50.80 [2.00]	1-796866-1
12	55.88 [2.20]	1-796866-2

No. of Positions	Dim. A	Part Numbers
13	60.96 [2.40]	1-796866-3
14	66.04 [2.60]	1-796866-4
15	71.12 [2.80]	1-796866-5
16	76.20 [3.00]	1-796866-6
17	81.28 [3.20]	1-796866-7
18	86.36 [3.40]	1-796866-8
19	91.44 [3.60]	1-796866-9
20	96.52 [3.80]	2-796866-0
21	101.60 [4.00]	2-796866-1
22	106.68 [4.20]	2-796866-2
23	111.76 [4.40]	2-796866-3

Note: All part numbers are RoHS Compliant.

Two-Piece Terminal Block Connectors (Continued)

Straight, Open End Headers, 3.5 mm Centerline

UL Rating – 300 V, 11 A

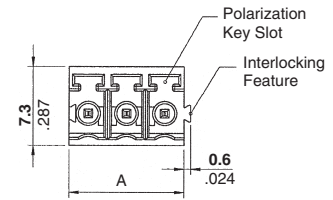
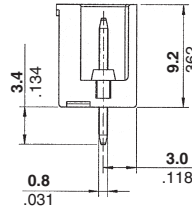
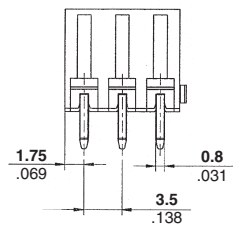
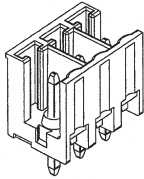

Recommended PC Board Layout

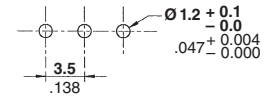

No. of Positions	Dim. A	Part Numbers Green
2	7.0 [0.276]	284515-2
3	10.5 [0.413]	284515-3
4	14.0 [0.551]	284515-4
5	17.5 [0.689]	284515-5
6	21.0 [0.827]	284515-6
7	24.5 [0.965]	284515-7
8	28.0 [1.102]	284515-8
9	31.5 [1.240]	284515-9
10	35.0 [1.378]	1-284515-0
11	38.5 [1.516]	1-284515-1
12	42.0 [1.654]	1-284515-2
13	45.5 [1.791]	1-284515-3

No. of Positions	Dim. A	Part Numbers Green
14	49.0 [1.929]	1-284515-4
15	52.5 [2.067]	1-284515-5
16	56.0 [2.205]	1-284515-6
17	59.5 [2.343]	1-284515-7
18	63.0 [2.480]	1-284515-8
19	66.5 [2.618]	1-284515-9
20	70.0 [2.756]	2-284515-0
21	73.5 [2.894]	2-284515-1
22	77.0 [3.031]	2-284515-2
23	80.5 [3.169]	2-284515-3
24	84.0 [3.307]	2-284515-4
25	87.5 [3.445]	2-284515-5

Straight, Closed End Headers, 3.5 mm Centerline

UL Rating – 300 V, 11 A

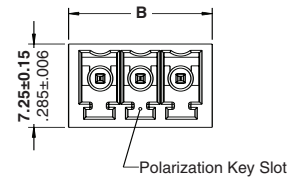
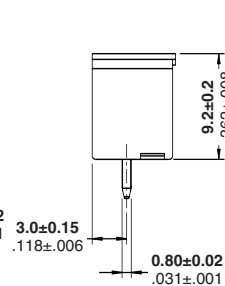
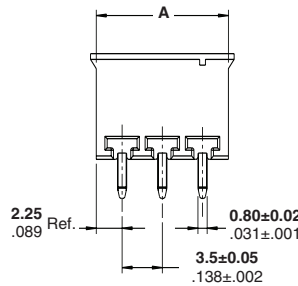
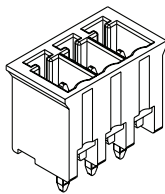

Recommended PC Board Layout

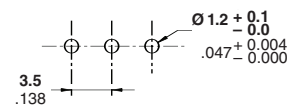

Number of Positions	Dimensions		Part Numbers		
	A	B	Green	Blue	Black*
2	8.0 [0.315]	9.0 [0.354]	284514-2	796694-2	1776130-2
3	11.5 [0.453]	12.5 [0.492]	284514-3	796694-3	1776130-3
4	15.0 [0.590]	16.0 [0.630]	284514-4	796694-4	1776130-4
5	18.5 [0.728]	19.5 [0.768]	284514-5	796694-5	1776130-5
6	22.0 [0.866]	23.0 [0.906]	284514-6	796694-6	1776130-6
7	25.5 [1.004]	26.5 [1.043]	284514-7	796694-7	1776130-7
8	29.0 [1.142]	30.0 [1.181]	284514-8	796694-8	1776130-8
9	32.5 [1.280]	33.5 [1.319]	284514-9	796694-9	1776130-9
10	36.0 [1.417]	37.0 [1.457]	1-284514-0	1-796694-0	1-1776130-0
11	39.5 [1.555]	40.5 [1.594]	1-284514-1	1-796694-1	1-1776130-1
12	43.0 [1.693]	44.0 [1.732]	1-284514-2	1-796694-2	1-1776130-2
13	46.5 [1.831]	47.5 [1.870]	1-284514-3	1-796694-3	—

Number of Positions	Dimensions		Part Numbers		
	A	B	Green	Blue	Black*
14	50.0 [1.968]	51.0 [2.008]	1-284514-4	1-796694-4	—
15	53.5 [2.106]	54.5 [2.146]	1-284514-5	1-796694-5	—
16	57.0 [2.244]	58.0 [2.283]	1-284514-6	1-796694-6	—
17	60.5 [2.382]	61.5 [2.421]	1-284514-7	1-796694-7	—
18	64.0 [2.520]	65.0 [2.599]	1-284514-8	1-796694-8	—
19	67.5 [2.657]	68.5 [2.697]	1-284514-9	1-796694-9	—
20	71.0 [2.795]	72.0 [2.835]	2-284514-0	2-796694-0	—
21	74.5 [2.933]	75.5 [2.972]	2-284514-1	2-796694-1	—
22	78.0 [3.071]	79.0 [3.110]	2-284514-2	2-796694-2	—
23	81.5 [3.209]	82.5 [3.248]	2-284514-3	2-796694-3	—
24	85.0 [3.346]	86.0 [3.386]	2-284514-4	2-796694-4	—
25	88.5 [3.484]	89.5 [3.524]	2-284514-5	2-796694-5	—

Note: BUCHANAN Terminal Block Series B73N3VxxT has been superseded/replaced with 796694-xx.

*Wave solder process capable to 265°C [509°F] for 10 seconds. Dimensions may vary from what is shown for High Temperature Parts. Please check Customer Drawing.



Note: All part numbers are RoHS Compliant.

Two-Piece Terminal Block Connectors (Continued)

**Straight, Open End Headers,
3.81 mm Centerline
Color – Green
UL Rating – 300 V, 11 A**

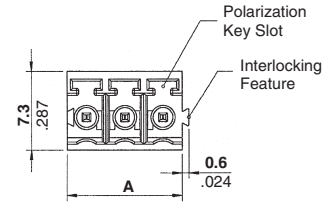
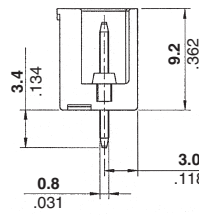
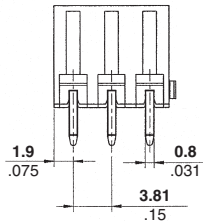
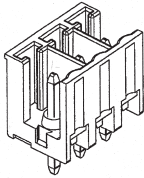

Recommended PC Board Layout

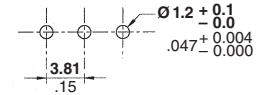

No. of Positions	Dim. A	Part Numbers
2	7.62 [0.30]	284518-2
3	11.43 [0.45]	284518-3
4	15.24 [0.60]	284518-4
5	19.05 [0.75]	284518-5
6	22.86 [0.90]	284518-6
7	26.67 [1.05]	284518-7
8	30.48 [1.20]	284518-8
9	34.29 [1.35]	284518-9
10	38.10 [1.50]	1-284518-0
11	41.91 [1.65]	1-284518-1
12	45.72 [1.80]	1-284518-2
13	49.53 [1.95]	1-284518-3

No. of Positions	Dim. A	Part Numbers
14	53.34 [2.10]	1-284518-4
15	57.15 [2.25]	1-284518-5
16	60.96 [2.40]	1-284518-6
17	64.77 [2.55]	1-284518-7
18	68.58 [2.70]	1-284518-8
19	72.39 [2.85]	1-284518-9
20	76.20 [3.00]	2-284518-0
21	80.01 [3.15]	2-284518-1
22	83.82 [3.30]	2-284518-2
23	87.63 [3.45]	2-284518-3
24	91.44 [3.60]	2-284518-4
25	95.25 [3.75]	2-284518-5

**Straight, Closed End Headers,
3.81 mm Centerline
UL Rating – 300 V, 11 A**

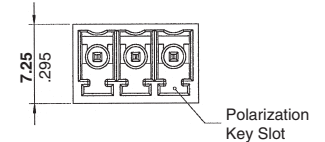
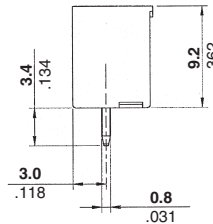
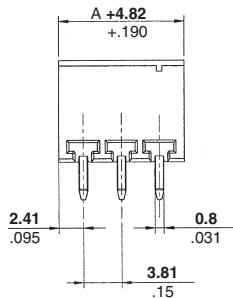
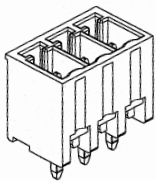

Recommended PC Board Layout

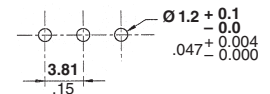

No. of Positions	Dim. A	Part Numbers	
		Green	Black*
2	3.81 [0.15]	284517-2	1776131-2
3	7.62 [0.30]	284517-3	1776131-3
4	11.43 [0.45]	284517-4	1776131-4
5	15.24 [0.60]	284517-5	1776131-5
6	19.05 [0.75]	284517-6	1776131-6
7	22.86 [0.90]	284517-7	1776131-7
8	26.67 [1.05]	284517-8	1776131-8
9	30.48 [1.20]	284517-9	1776131-9
10	34.29 [1.35]	1-284517-0	1-1776131-0
11	38.10 [1.50]	1-284517-1	1-1776131-1
12	41.91 [1.65]	1-284517-2	1-1776131-2
13	45.72 [1.80]	1-284517-3	—

No. of Positions	Dim. A	Part Numbers	
		Green	Black*
14	53.34 [2.10]	1-284517-4	—
15	57.15 [2.25]	1-284517-5	—
16	60.96 [2.40]	1-284517-6	—
17	64.77 [2.55]	1-284517-7	—
18	68.58 [2.70]	1-284517-8	—
19	72.39 [2.85]	1-284517-9	—
20	76.20 [3.00]	2-284517-0	—
21	80.01 [3.15]	2-284517-1	—
22	83.82 [3.30]	2-284517-2	—
23	87.63 [3.45]	2-284517-3	—
24	91.44 [3.60]	2-284517-4	—
25	95.25 [3.75]	2-284517-5	—

*Wave solder process capable to 265°C [509°F] for 10 seconds. Dimensions may vary from what is shown for High Temperature Parts. Please check Customer Drawing.

Note: All part numbers are RoHS Compliant.

Two-Piece Terminal Block Connectors (Continued)

Straight, Open End Stacking Headers, 5.0 mm Centerline Color – See chart.

UL Rating – 300 V, 15 A

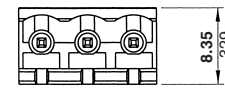
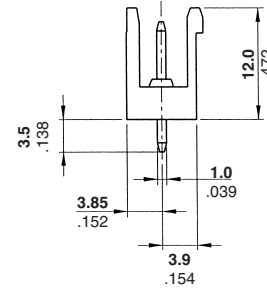
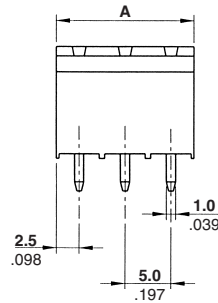
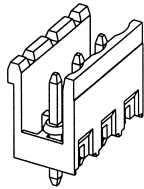

Recommended PC Board Layout

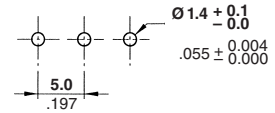

No. of Positions	Dim. A	Part Numbers				
		Gray	Green	Blue	Black*	
2	10.0 [0.394]	1546212-2	282822-2	796697-2	1776138-2	
3	15.0 [0.591]	1546212-3	282822-3	796697-3	1776138-3	
4	20.0 [0.787]	1546212-4	282822-4	796697-4	1776138-4	
5	25.0 [0.984]	1546212-5	282822-5	796697-5	1776138-5	
6	30.0 [1.181]	1546212-6	282822-6	796697-6	1776138-6	
7	35.0 [1.378]	1546212-7	282822-7	796697-7	1776138-7	
8	40.0 [1.575]	1546212-8	282822-8	796697-8	1776138-8	
9	45.0 [1.772]	1546212-9	282822-9	796697-9	1776138-9	
10	50.0 [1.968]	1-1546212-0	1-282822-0	1-796697-0	1-1776138-0	
11	55.0 [2.165]	1-1546212-1	1-282822-1	1-796697-1	1-1776138-1	
12	60.0 [2.362]	1-1546212-2	1-282822-2	1-796697-2	1-1776138-2	
13	65.0 [2.559]	1-1546212-3	1-282822-3	1-796697-3	—	

No. of Positions	Dim. A	Part Numbers				
		Gray	Green	Blue	Black*	
14	70.0 [2.756]	1-1546212-4	1-282822-4	1-796697-4	—	
15	75.0 [2.953]	1-1546212-5	1-282822-5	1-796697-5	—	
16	80.0 [3.150]	1-1546212-6	1-282822-6	1-796697-6	—	
17	85.0 [3.346]	1-1546212-7	1-282822-7	1-796697-7	—	
18	90.0 [3.543]	1-1546212-8	1-282822-8	1-796697-8	—	
19	95.0 [3.740]	1-1546212-9	1-282822-9	1-796697-9	—	
20	100.0 [3.937]	2-1546212-0	2-282822-0	2-796697-0	—	
21	105.0 [4.134]	2-1546212-1	2-282822-1	2-796697-1	—	
22	110.0 [4.331]	2-1546212-2	2-282822-2	2-796697-2	—	
23	115.0 [4.528]	2-1546212-3	2-282822-3	2-796697-3	—	
24	120.0 [4.724]	2-1546212-4	2-282822-4	2-796697-4	—	
25	125.0 [4.921]	2-1546212-5	2-282822-5	2-796697-5	—	

Note: BUCHANAN Terminal Block Series B72N4VxxT has been replaced by x-796697-x (blue).

*Wave solder process capable to 265°C [509°F] for 10 seconds. Dimensions may vary from what is shown for High Temperature Parts. Please check Customer Drawing.

Straight, Closed End Headers, 5.0 mm Centerline Color – See chart.

UL Rating – 300 V, 15 A

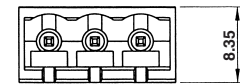
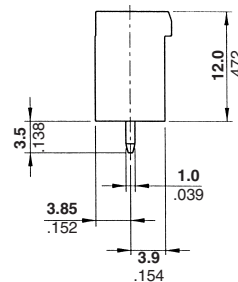
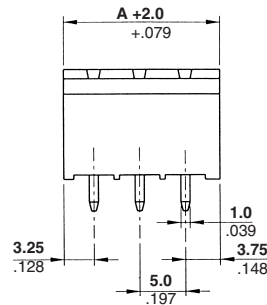
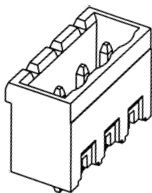

Recommended PC Board Layout

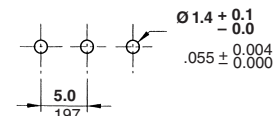

No. of Pos.	Dim. A	Part Numbers				
		Gray	Green	Blue	Black*	
2	10.0 [0.394]	1546211-2	796642-2	796699-2	1776146-2	
3	15.0 [0.591]	1546211-3	796642-3	796699-3	1776146-3	
4	20.0 [0.787]	1546211-4	796642-4	796699-4	1776146-4	
5	25.0 [0.984]	1546211-5	796642-5	796699-5	1776146-5	
6	30.0 [1.181]	1546211-6	796642-6	796699-6	1776146-6	
7	35.0 [1.378]	1546211-7	796642-7	796699-7	1776146-7	
8	40.0 [1.575]	1546211-8	796642-8	796699-8	1776146-8	
9	45.0 [1.772]	1546211-9	796642-9	796699-9	1776146-9	
10	50.0 [1.968]	1-1546211-0	1-796642-0	1-796699-0	1-1776146-0	
11	55.0 [2.165]	1-1546211-1	1-796642-1	1-796699-1	1-1776146-1	
12	60.0 [2.362]	1-1546211-2	1-796642-2	1-796699-2	1-1776146-2	
13	65.0 [2.559]	1-1546211-3	1-796642-3	1-796699-3	—	

No. of Positions	Dim. A	Part Numbers				
		Gray	Green	Blue	Black	
14	70.0 [2.756]	1-1546211-4	1-796642-4	1-796699-4	1-796643-4	
15	75.0 [2.953]	1-1546211-5	1-796642-5	1-796699-5	1-796643-5	
16	80.0 [3.150]	1-1546211-6	1-796642-6	1-796699-6	1-796643-6	
17	85.0 [3.346]	1-1546211-7	1-796642-7	1-796699-7	1-796643-7	
18	90.0 [3.543]	1-1546211-8	1-796642-8	1-796699-8	1-796643-8	
19	95.0 [3.740]	1-1546211-9	1-796642-9	1-796699-9	1-796643-9	
20	100.0 [3.937]	2-1546211-0	2-796642-0	2-796699-0	2-796643-0	
21	105.0 [4.134]	2-1546211-1	2-796642-1	2-796699-1	2-796643-1	
22	110.0 [4.331]	2-1546211-2	2-796642-2	2-796699-2	2-796643-2	
23	115.0 [4.528]	2-1546211-3	2-796642-3	2-796699-3	2-796643-3	
24	120.0 [4.724]	2-1546211-4	2-796642-4	2-796699-4	2-796643-4	
25	125.0 [4.921]	2-1546211-5	2-796642-5	2-796699-5	2-796643-5	

Note: BUCHANAN Terminal Block Series B73N4VxxT has been replaced with 796699-xx (blue) and 796643-xx (black).

RDI Terminal Block Series 2EHDV-xx has been replaced with 796642-xx (green) and 796643-xx (black).

*Wave solder process capable to 265°C [509°F] for 10 seconds. Dimensions may vary from what is shown for High Temperature Parts. Please check Customer Drawing.

Note: All part numbers are RoHS Compliant.

Two-Piece Terminal Block Connectors (Continued)

Straight, Open End Stacking Headers, 5.08 mm Centerline Color – See chart. UL Rating – 300 V, 15 A

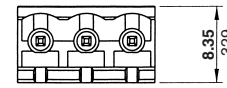
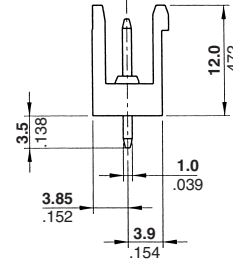
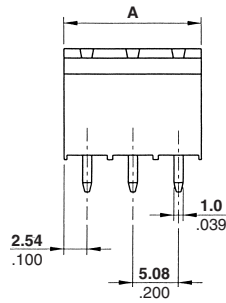
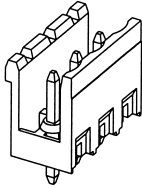

Recommended PC Board Layout

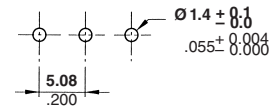

No. of Positions	Dim. A	Part Numbers		
		Green	Gray	Black*
2	10.16 [0.40]	282825-2	1546213-2	1776139-2
3	15.24 [0.60]	282825-3	1546213-3	1776139-3
4	20.32 [0.80]	282825-4	1546213-4	1776139-4
5	25.40 [1.00]	282825-5	1546213-5	1776139-5
6	30.48 [1.20]	282825-6	1546213-6	1776139-6
7	35.56 [1.40]	282825-7	1546213-7	1776139-7
8	40.64 [1.60]	282825-8	1546213-8	1776139-8
9	45.72 [1.80]	282825-9	1546213-9	—
10	50.80 [2.00]	1-282825-0	1-1546213-0	—
11	55.88 [2.20]	1-282825-1	1-1546213-1	—
12	60.96 [2.40]	1-282825-2	1-1546213-2	—
13	66.04 [2.60]	1-282825-3	1-1546213-3	—

No. of Positions	Dim. A	Part Numbers		
		Green	Gray	Black*
14	71.12 [2.80]	1-282825-4	1-1546213-4	—
15	76.20 [3.00]	1-282825-5	1-1546213-5	—
16	81.28 [3.20]	1-282825-6	1-1546213-6	—
17	86.36 [3.40]	1-282825-7	1-1546213-7	—
18	91.44 [3.60]	1-282825-8	1-1546213-8	—
19	96.52 [3.80]	1-282825-9	1-1546213-9	—
20	101.60 [4.00]	2-282825-0	2-1546213-0	—
21	106.68 [4.20]	2-282825-1	2-1546213-1	—
22	111.76 [4.40]	2-282825-2	2-1546213-2	—
23	116.84 [4.60]	2-282825-3	2-1546213-3	—
24	121.92 [4.80]	2-282825-4	2-1546213-4	—
25	127.00 [5.00]	2-282825-5	2-1546213-5	—

*Wave solder process capable to 265°C [509°F] for 10 seconds. Dimensions may vary from what is shown for High Temperature Parts. Please check Customer Drawing.

Straight, Closed End Headers, 5.08 mm Centerline Color – See chart. UL Rating – 300 V, 15 A

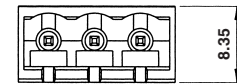
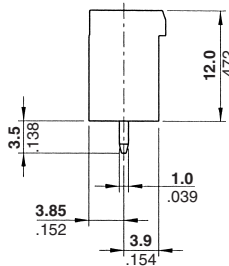
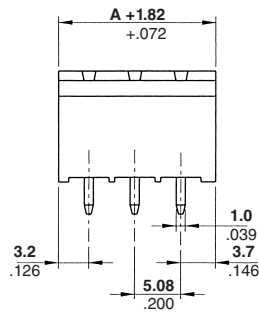
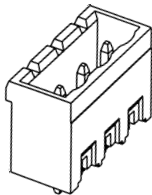

Recommended PC Board Layout

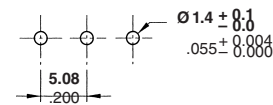

No. of Pos.	Dim. A	Part Numbers			
		Gray	Green	Black	Black*
2	10.16 [0.40]	1546111-2	796636-2	796637-2	1776147-2
3	15.24 [0.60]	1546111-3	796636-3	796637-3	1776147-3
4	20.32 [0.80]	1546111-4	796636-4	796637-4	1776147-4
5	25.40 [1.00]	1546111-5	796636-5	796637-5	1776147-5
6	30.48 [1.20]	1546111-6	796636-6	796637-6	1776147-6
7	35.56 [1.40]	1546111-7	796636-7	796637-7	1776147-7
8	40.64 [1.60]	1546111-8	796636-8	796637-8	1776147-8
9	45.72 [1.80]	1546111-9	796636-9	796637-9	—
10	50.80 [2.00]	1-1546111-0	1-796636-0	1-796637-0	—
11	55.88 [2.20]	1-1546111-1	1-796636-1	1-796637-1	—
12	60.96 [2.40]	1-1546111-2	1-796636-2	1-796637-2	—
13	66.04 [2.60]	1-1546111-3	1-796636-3	1-796637-3	—

No. of Positions	Dim. A	Part Numbers		
		Gray	Green	Black
14	71.12 [2.80]	1-1546111-4	1-796636-4	1-796637-4
15	76.20 [3.00]	1-1546111-5	1-796636-5	1-796637-5
16	81.28 [3.20]	1-1546111-6	1-796636-6	1-796637-6
17	86.36 [3.40]	1-1546111-7	1-796636-7	1-796637-7
18	91.44 [3.60]	1-1546111-8	1-796636-8	1-796637-8
19	96.52 [3.80]	1-1546111-9	1-796636-9	1-796637-9
20	101.60 [4.00]	2-1546111-0	2-796636-0	1-796637-0
21	106.68 [4.20]	2-1546111-1	2-796636-1	2-796637-1
22	111.76 [4.40]	2-1546111-2	2-796636-2	2-796637-2
23	116.84 [4.60]	2-1546111-3	2-796636-3	2-796637-3
24	121.92 [4.80]	2-1546111-4	2-796636-4	2-796637-4
25	127.00 [5.00]	2-1546111-5	2-796636-5	2-796637-5

Note: BUCHANAN Terminal Block Series B2EHDVxx has been superceded/replaced with 796636-xx (green) and 796637-xx (black).

*Wave solder process capable to 265°C [509°F] for 10 seconds. Dimensions may vary from what is shown for High Temperature Parts. Please check Customer Drawing.

Note: All part numbers are RoHS Compliant.

Two-Piece Terminal Block Connectors (Continued)

Straight, Open End Headers, 7.5 mm Centerline
UL Rating – 300 V, 15 A

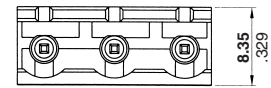
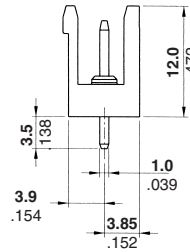
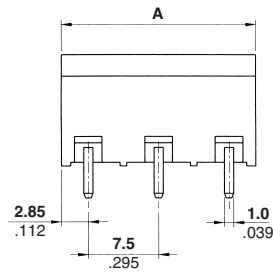
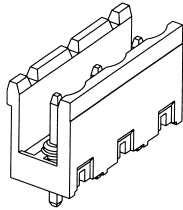

Recommended PC Board Layout

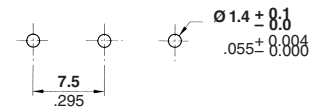

No. of Positions	Dim. A	Part Numbers	
		Green	Black*
2	13.2 [0.520]	282963-2	1776149-2
3	20.7 [0.815]	282963-3	1776149-3
4	28.2 [1.110]	282963-4	1776149-4
5	35.7 [1.406]	282963-5	1776149-5
6	43.2 [1.701]	282963-6	1776149-6
7	50.7 [1.996]	282963-7	1776149-7

No. of Positions	Dim. A	Part Numbers	
		Green	Black*
8	58.2 [2.291]	282963-8	1776149-8
9	65.7 [2.587]	282963-9	1776149-9
10	73.2 [2.882]	1-282963-0	1-1776149-0
11	80.7 [3.177]	1-282963-1	1-1776149-1
12	88.2 [3.472]	1-282963-2	1-1776149-2

*Wave solder process capable to 265°C [509°F] for 10 seconds. Dimensions may vary from what is shown for High Temperature Parts. Please check Customer Drawing.

Straight, Closed End Headers, 7.5 mm Centerline
UL Rating – 300 V, 15 A

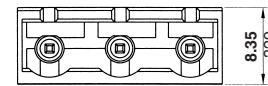
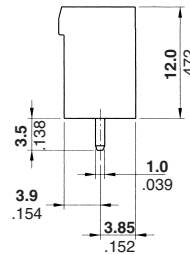
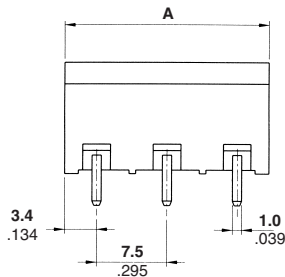
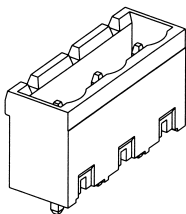

Recommended PC Board Layout

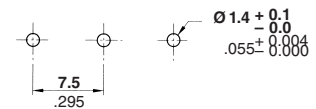

No. of Positions	Dim. A	Part Numbers	
		Green	Black*
2	14.3 [0.563]	282964-2	1776153-2
3	21.8 [0.858]	282964-3	1776153-3
4	29.3 [1.154]	282964-4	1776153-4
5	36.8 [1.449]	282964-5	1776153-5
6	44.3 [1.744]	282964-6	1776153-6
7	51.8 [2.039]	282964-7	1776153-7

No. of Positions	Dim. A	Part Numbers	
		Green	Black*
8	59.3 [2.335]	282964-8	1776153-8
9	66.8 [2.630]	282964-9	1776153-9
10	74.3 [2.925]	1-282964-0	1-1776153-0
11	81.8 [3.220]	1-282964-1	1-1776153-1
12	89.3 [3.516]	1-282964-2	1-1776153-2

*Wave solder process capable to 265°C [509°F] for 10 seconds. Dimensions may vary from what is shown for High Temperature Parts. Please check Customer Drawing.

Note: All part numbers are RoHS Compliant.

Two-Piece Terminal Block Connectors (Continued)

Straight, Open End Headers, 7.62 mm Centerline
UL Rating – 300 V, 15 A

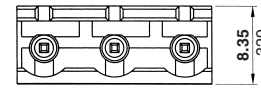
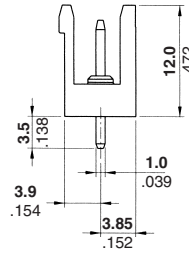
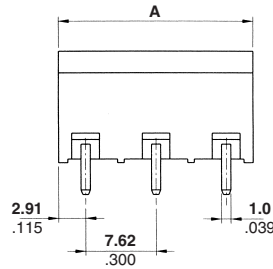
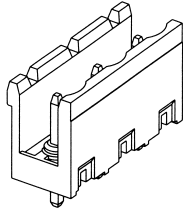

Recommended PC Board Layout

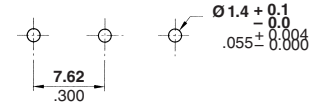

No. of Positions	Dim. A	Part Numbers	
		Green	Black*
2	13.44 [0.529]	282967-2	1776150-2
3	21.06 [0.829]	282967-3	1776150-3
4	28.68 [1.129]	282967-4	1776150-4
5	36.30 [1.429]	282967-5	1776150-5
6	43.92 [1.729]	282967-6	1776150-6
7	51.54 [2.029]	282967-7	1776150-7

No. of Positions	Dim. A	Part Numbers	
		Green	Black*
8	59.16 [2.329]	282967-8	1776150-8
9	66.78 [2.629]	282967-9	1776150-9
10	74.40 [2.929]	1-282967-0	1-1776150-0
11	82.02 [3.229]	1-282967-1	1-1776150-1
12	89.64 [3.529]	1-282967-2	1-1776150-2

*Wave solder process capable to 265°C [509°F] for 10 seconds. Dimensions may vary from what is shown for High Temperature Parts. Please check Customer Drawing.

Straight, Closed End Headers, 7.62 mm Centerline
UL Rating – 300 V, 15 A

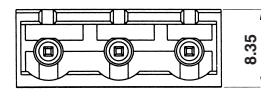
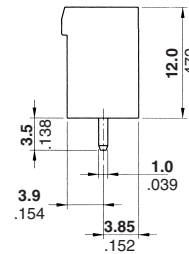
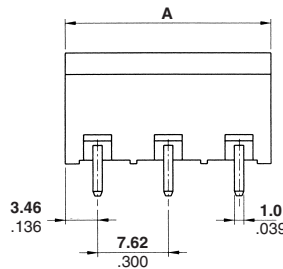
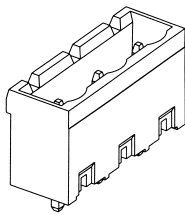

Recommended PC Board Layout

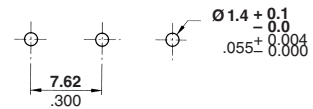

No. of Positions	Dim. A	Part Numbers	
		Green	Black*
2	14.54 [0.572]	796980-2	1776154-2
3	22.16 [0.872]	796980-3	1776154-3
4	29.78 [1.172]	796980-4	1776154-4
5	37.40 [1.472]	796980-5	1776154-5
6	45.02 [1.772]	796980-6	1776154-6
7	52.64 [2.072]	796980-7	1776154-7

No. of Positions	Dim. A	Part Numbers	
		Green	Black*
8	60.26 [2.372]	796980-8	1776154-8
9	67.88 [2.672]	796980-9	1776154-9
10	75.50 [2.972]	1-796980-0	1-1776154-0
11	83.12 [3.272]	1-796980-1	1-1776154-1
12	90.74 [3.572]	1-796980-2	1-1776154-2

*Wave solder process capable to 265°C [509°F] for 10 seconds. Dimensions may vary from what is shown for High Temperature Parts. Please check Customer Drawing.

Note: All part numbers are RoHS Compliant.

Two-Piece Terminal Block Connectors (Continued)

**Straight,
Open End Headers,
10.0 mm Centerline
UL Rating – 600 V, 24 A**

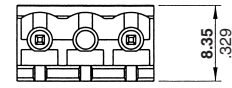
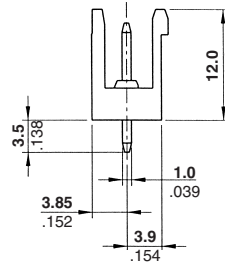
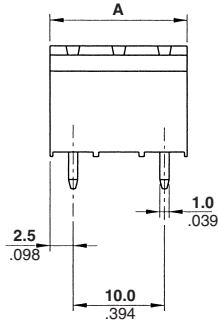
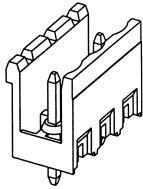

Recommended PC Board Layout

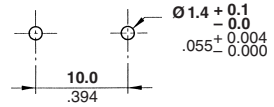

No. of Positions	Dim. A	Part Numbers	
		Green	Black*
2	15.0 [0.591]	282827-2	1776156-2
3	25.0 [0.984]	282827-3	1776156-3
4	35.0 [1.378]	282827-4	1776156-4
5	45.0 [1.772]	282827-5	—
6	55.0 [2.165]	282827-6	—
7	65.0 [2.559]	282827-7	—

No. of Positions	Dim. A	Part Numbers	
		Green	Black*
8	75.0 [2.953]	282827-8	—
9	85.0 [3.346]	282827-9	—
10	95.0 [3.740]	1-282827-0	—
11	105.0 [4.134]	1-282827-1	—
12	115.0 [4.528]	1-282827-2	—
13	125.0 [4.921]	1-282827-3	—

*Wave solder process capable to 265°C [509°F] for 10 seconds. Dimensions may vary from what is shown for High Temperature Parts. Please check Customer Drawing.

**Straight,
Closed End Headers,
10.0 mm Centerline
UL Rating – 600 V, 24 A**

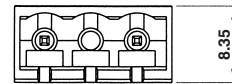
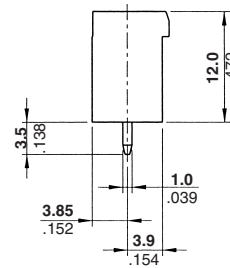
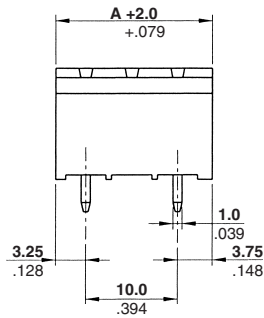
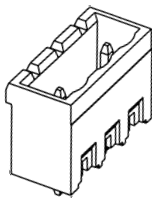

Recommended PC Board Layout

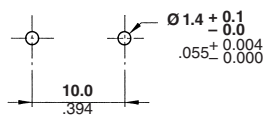

No. of Positions	Dim. A	Part Numbers	
		Green	Black*
2	15.0 [0.591]	282826-2	1776160-2
3	25.0 [0.984]	282826-3	1776160-3
4	35.0 [1.378]	282826-4	1776160-4
5	45.0 [1.772]	282826-5	—
6	55.0 [2.165]	282826-6	—
7	65.0 [2.559]	282826-7	—

No. of Positions	Dim. A	Part Numbers	
		Green	Black*
8	75.0 [2.953]	282826-8	—
9	85.0 [3.346]	282826-9	—
10	95.0 [3.740]	1-282826-0	—
11	105.0 [4.134]	1-282826-1	—
12	115.0 [4.528]	1-282826-2	—
13	125.0 [4.921]	1-282826-3	—

*Wave solder process capable to 265°C [509°F] for 10 seconds. Dimensions may vary from what is shown for High Temperature Parts. Please check Customer Drawing.



Note: All part numbers are RoHS Compliant.

Two-Piece Terminal Block Connectors (Continued)

Straight, Open End Headers, 10.16 mm Centerline
UL Rating – 600 V, 15 A

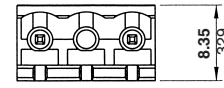
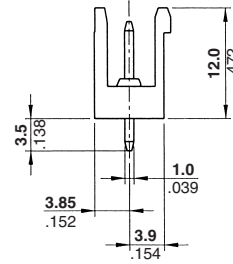
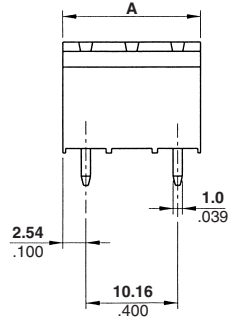
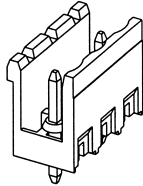

Recommended PC Board Layout

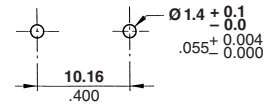

No. of Positions	Dim. A	Part Numbers Black*
2	15.24 [0.60]	1776157-2
3	25.40 [1.00]	1776157-3
4	35.56 [1.40]	1776157-4

*Wave solder process capable to 265°C [509°F] for 10 seconds
Dimensions may vary from what is shown for High Temperature Parts.
Please check Customer Drawing.

Straight, Closed End Headers, 10.16 mm Centerline
UL Rating – 600 V, 15 A

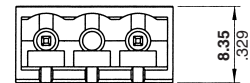
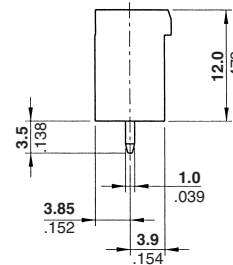
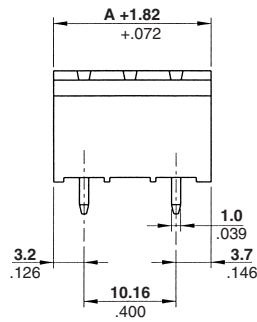
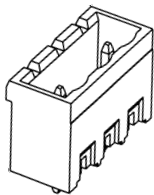

Recommended PC Board Layout

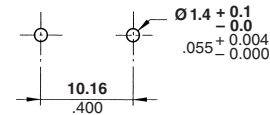

No. of Positions	Dim. A	Part Numbers	
		Green	Black*
2	15.24 [0.60]	282828-2	1776161-2
3	25.40 [1.00]	282828-3	1776161-3
4	35.56 [1.40]	282828-4	1776161-4
5	45.72 [1.80]	282828-5	—
6	55.88 [2.20]	282828-6	—
7	66.04 [2.60]	282828-7	—

No. of Positions	Dim. A	Part Numbers	
		Green	Black*
8	76.20 [3.00]	282828-8	—
9	86.36 [3.40]	282828-9	—
10	96.52 [3.80]	1-282828-0	—
11	106.68 [4.20]	1-282828-1	—
12	116.84 [4.60]	1-282828-2	—
13	127.00 [5.00]	1-282828-3	—

*Wave solder process capable to 265°C [509°F] for 10 seconds. Dimensions may vary from what is shown for High Temperature Parts. Please check Customer Drawing.

Note: All part numbers are RoHS Compliant.

Two-Piece Terminal Block Connectors (Continued)

Straight, Open End Stacking Headers w/Interlock, 5.0 mm Centerline
UL Rating – 300 V, 15 A

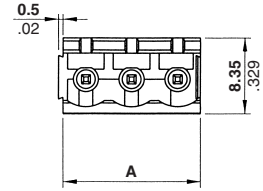
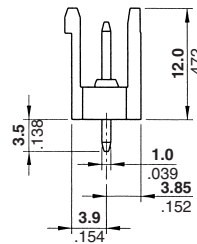
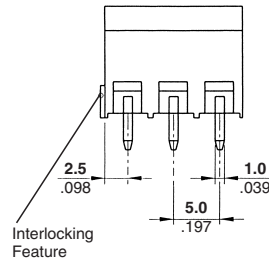
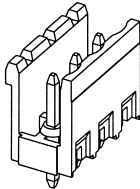

Recommended PC Board Layout

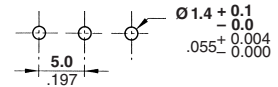

No. of Positions	Dim. A	Part Numbers	
		Green	Black*
2	10.0 [.394]	282821-2	1776142-2
3	15.0 [.591]	282821-3	1776142-3
4	20.0 [.787]	282821-4	1776142-4

*Wave solder process capable to 265°C [509°F] for 10 seconds
Dimensions may vary from what is shown for High Temperature Parts.
Please check Customer Drawing.

Straight, Open End Stacking Headers w/Interlock, 5.08 mm Centerline
UL Rating – 300 V, 15 A

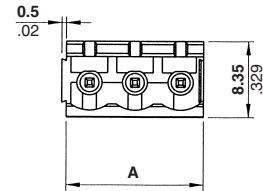
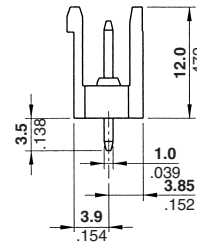
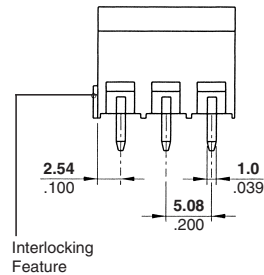
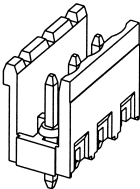

Recommended PC Board Layout

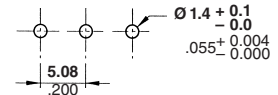

No. of Positions	Dim. A	Part Numbers	
		Green	Black*
2	10.16 [.400]	282824-2	1776143-2
3	15.24 [.600]	282824-3	1776143-3
4	20.32 [.800]	282824-4	1776143-4

*Wave solder process capable to 265°C [509°F] for 10 seconds
Dimensions may vary from what is shown for High Temperature Parts.
Please check Customer Drawing.

Note: All part numbers are RoHS Compliant.

Two-Piece Terminal Block Connectors (Continued)

Right-Angle, Closed End Headers, 3.5 mm Centerline Color – See chart. UL Rating – 300 V, 11 A

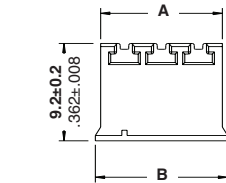
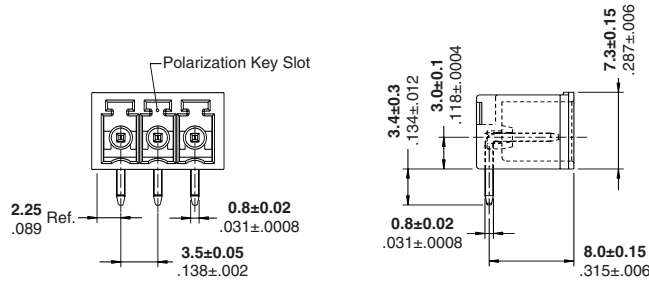
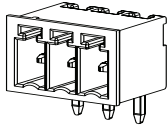

Recommended PC Board Layout

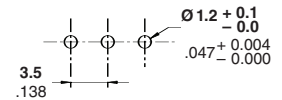

Number of Positions	Dimensions		Part Numbers		
	A	B	Green	Blue	Black*
2	8.0 [0.315]	9.0 [0.354]	284512-2	796695-2	1776134-2
3	11.5 [0.453]	12.5 [0.492]	284512-3	796695-3	1776134-3
4	15.0 [0.590]	16.0 [0.630]	284512-4	796695-4	1776134-4
5	18.5 [0.728]	19.5 [0.768]	284512-5	796695-5	1776134-5
6	22.0 [0.866]	23.0 [0.906]	284512-6	796695-6	1776134-6
7	25.5 [1.004]	26.5 [1.043]	284512-7	796695-7	1776134-7
8	29.0 [1.142]	30.0 [1.181]	284512-8	796695-8	1776134-8
9	32.5 [1.280]	33.5 [1.319]	284512-9	796695-9	—
10	36.0 [1.417]	37.0 [1.457]	1-284512-0	1-796695-0	—
11	39.5 [1.555]	40.5 [1.594]	1-284512-1	1-796695-1	—
12	43.0 [1.693]	44.0 [1.732]	1-284512-2	1-796695-2	—
13	46.5 [1.831]	47.5 [1.870]	1-284512-3	1-796695-3	—

Number of Positions	Dimensions		Part Numbers		
	A	B	Green	Blue	Black*
14	50.0 [1.968]	51.0 [2.008]	1-284512-4	1-796695-4	—
15	53.5 [2.106]	54.5 [2.146]	1-284512-5	1-796695-5	—
16	57.0 [2.244]	58.0 [2.283]	1-284512-6	1-796695-6	—
17	60.5 [2.382]	61.5 [2.421]	1-284512-7	1-796695-7	—
18	64.0 [2.520]	65.0 [2.559]	1-284512-8	1-796695-8	—
19	67.5 [2.657]	68.5 [2.697]	1-284512-9	1-796695-9	—
20	71.0 [2.795]	72.0 [2.835]	2-284512-0	2-796695-0	—
21	74.5 [2.933]	75.5 [2.972]	2-284512-1	2-796695-1	—
22	78.0 [3.071]	79.0 [3.110]	2-284512-2	2-796695-2	—
23	81.5 [3.209]	82.5 [3.248]	2-284512-3	2-796695-3	—
24	85.0 [3.346]	86.0 [3.386]	2-284512-4	2-796695-4	—
25	88.5 [3.484]	89.5 [3.524]	2-284512-5	2-796695-5	—

Note: BUCHANAN Terminal Block Series B73N3HxxT has been replaced with Part Number 796695-xx (blue).

*Wave solder process capable to 265°C [509°F] for 10 seconds. Dimensions may vary from what is shown for High Temperature Parts. Please check Customer Drawing.

Right-Angle, Closed End Headers, 3.81 mm Centerline UL Rating – 300 V, 11 A

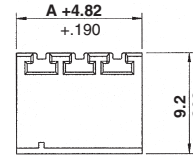
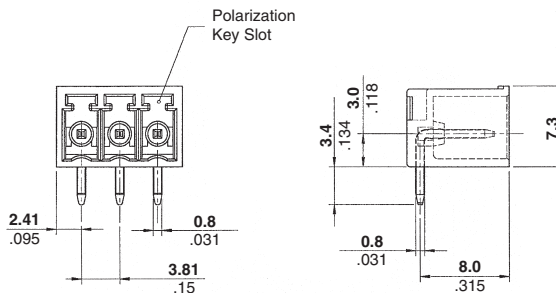
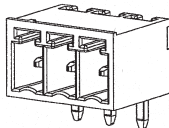

Recommended PC Board Layout

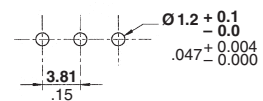

No. of Positions	Dim. A	Part Numbers	
		Green	Black*
2	3.81 [0.15]	284513-2	1776135-2
3	7.62 [0.30]	284513-3	1776135-3
4	11.43 [0.45]	284513-4	1776135-4
5	15.24 [0.60]	284513-5	1776135-5
6	19.05 [0.75]	284513-6	1776135-6
7	22.86 [0.90]	284513-7	1776135-7
8	26.67 [1.05]	284513-8	1776135-8
9	30.48 [1.20]	284513-9	1776135-9
10	34.29 [1.35]	1-284513-0	1-1776135-0
11	38.10 [1.50]	1-284513-1	1-1776135-1
12	41.91 [1.65]	1-284513-2	1-1776135-2
13	45.72 [1.80]	1-284513-3	—

No. of Positions	Dim. A	Part Numbers	
		Green	Black*
14	49.53 [1.95]	1-284513-4	—
15	53.34 [2.10]	1-284513-5	—
16	57.15 [2.25]	1-284513-6	—
17	60.96 [2.40]	1-284513-7	—
18	64.77 [2.55]	1-284513-8	—
19	68.58 [2.70]	1-284513-9	—
20	72.39 [2.85]	2-284513-0	—
21	76.20 [3.00]	2-284513-1	—
22	80.01 [3.15]	2-284513-2	—
23	83.82 [3.30]	2-284513-3	—
24	87.63 [3.45]	2-284513-4	—
25	91.44 [3.60]	2-284513-5	—

*Wave solder process capable to 265°C [509°F] for 10 seconds. Dimensions may vary from what is shown for High Temperature Parts. Please check Customer Drawing.

Two-Piece Terminal Block Connectors (Continued)

**Right-Angle,
Open End Stacking Headers,
5.0 mm Centerline
Color – See chart.**

UL Rating – 300 V, 15 A

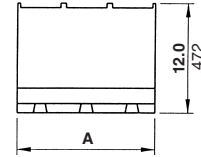
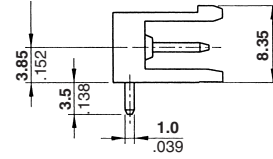
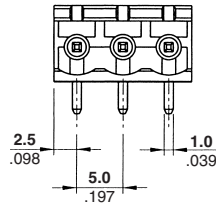
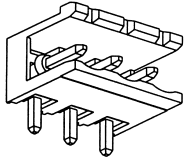

Recommended PC Board Layout

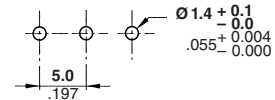

No. of Pos.	Dim. A	Part Numbers				
		Gray	Green	Blue	Black	Black*
2	10.0 [0.394]	1546210-2	282812-2	796698-2	1546179-2	1776140-2
3	15.0 [0.591]	1546210-3	282812-3	796698-3	1546179-3	1776140-3
4	20.0 [0.787]	1546210-4	282812-4	796698-4	1546179-4	1776140-4
5	25.0 [0.984]	1546210-5	282812-5	796698-5	1546179-5	1776140-5
6	30.0 [1.181]	1546210-6	282812-6	796698-6	1546179-6	1776140-6
7	35.0 [1.378]	1546210-7	282812-7	796698-7	1546179-7	1776140-7
8	40.0 [1.575]	1546210-8	282812-8	796698-8	1546179-8	1776140-8
9	45.0 [1.772]	1546210-9	282812-9	796698-9	1546179-9	1776140-9
10	50.0 [1.968]	1-1546210-0	1-282812-0	1-796698-0	1-1546179-0	1-1776140-0
11	55.0 [2.165]	1-1546210-1	1-282812-1	1-796698-1	1-1546179-1	1-1776140-1
12	60.0 [2.362]	1-1546210-2	1-282812-2	1-796698-2	1-1546179-2	1-1776140-2
13	65.0 [2.559]	1-1546210-3	1-282812-3	1-796698-3	1-1546179-3	—
14	70.0 [2.756]	1-1546210-4	1-282812-4	1-796698-4	1-1546179-4	—
15	75.0 [2.953]	1-1546210-5	1-282812-5	1-796698-5	1-1546179-5	—
16	80.0 [3.150]	1-1546210-6	1-282812-6	1-796698-6	1-1546179-6	—
17	85.0 [3.346]	1-1546210-7	1-282812-7	1-796698-7	1-1546179-7	—
18	90.0 [3.543]	1-1546210-8	1-282812-8	1-796698-8	1-1546179-8	—
19	95.0 [3.740]	1-1546210-9	1-282812-9	1-796698-9	1-1546179-9	—
20	100.0 [3.937]	2-1546210-0	2-282812-0	2-796698-0	2-1546179-0	—
21	105.0 [4.134]	2-1546210-1	2-282812-1	2-796698-1	2-1546179-1	—
22	110.0 [4.331]	2-1546210-2	2-282812-2	2-796698-2	2-1546179-2	—
23	115.0 [4.528]	2-1546210-3	2-282812-3	2-796698-3	2-1546179-3	—
24	120.0 [4.724]	2-1546210-4	2-282812-4	2-796698-4	2-1546179-4	—
25	125.0 [4.921]	2-1546210-5	2-282812-5	2-796698-5	2-1546179-5	—

Note: BUCHANAN Terminal Block Series B72N4HxxT has been replaced with 796698-xx (blue).
*Wave solder process capable to 265°C [509°F] for 10 seconds. Dimensions may vary from what is shown for High Temperature Parts. Please check Customer Drawing.

Note: All part numbers are RoHS Compliant.

Two-Piece Terminal Block Connectors (Continued)

Right-Angle, Closed End Headers, 5.0 mm Centerline Color – See chart. UL Rating – 300 V, 15 A

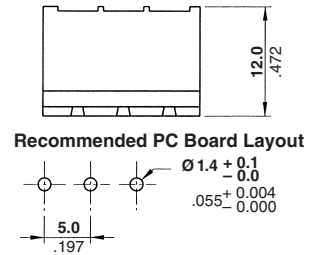
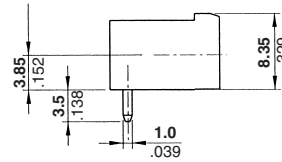
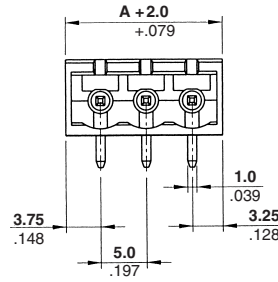
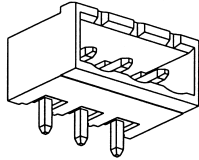

No. of Pos.	Dim. A	Part Numbers				
		Gray	Green	Blue	Black	Black*
2	10.0 [0.394]	1546209-2	796644-2	796700-2	796645-2	1776148-2
3	15.0 [0.591]	1546209-3	796644-3	796700-3	796645-3	1776148-3
4	20.0 [0.787]	1546209-4	796644-4	796700-4	796645-4	1776148-4
5	25.0 [0.984]	1546209-5	796644-5	796700-5	796645-5	1776148-5
6	30.0 [1.181]	1546209-6	796644-6	796700-6	796645-6	1776148-6
7	35.0 [1.378]	1546209-7	796644-7	796700-7	796645-7	1776148-7
8	40.0 [1.575]	1546209-8	796644-8	796700-8	796645-8	1776148-8
9	45.0 [1.772]	1546209-9	796644-9	796700-9	796645-9	—
10	50.0 [1.968]	1-1546209-0	1-796644-0	1-796700-0	1-796645-0	—
11	55.0 [2.165]	1-1546209-1	1-796644-1	1-796700-1	1-796645-1	—
12	60.0 [2.362]	1-1546209-2	1-796644-2	1-796700-2	1-796645-2	—
13	65.0 [2.559]	1-1546209-3	1-796644-3	1-796700-3	1-796645-3	—
14	70.0 [2.756]	1-1546209-4	1-796644-4	1-796700-4	1-796645-4	—
15	75.0 [2.953]	1-1546209-5	1-796644-5	1-796700-5	1-796645-5	—
16	80.0 [3.150]	1-1546209-6	1-796644-6	1-796700-6	1-796645-6	—
17	85.0 [3.346]	1-1546209-7	1-796644-7	1-796700-7	1-796645-7	—
18	90.0 [3.543]	1-1546209-8	1-796644-8	1-796700-8	1-796645-8	—
19	95.0 [3.740]	1-1546209-9	1-796644-9	1-796700-9	1-796645-9	—
20	100.0 [3.937]	2-1546209-0	2-796644-0	2-796700-0	2-796645-0	—
21	105.0 [4.134]	2-1546209-1	2-796644-1	2-796700-1	2-796645-1	—
22	110.0 [4.331]	2-1546209-2	2-796644-2	2-796700-2	2-796645-2	—
23	115.0 [4.528]	2-1546209-3	2-796644-3	2-796700-3	2-796645-3	—
24	120.0 [4.724]	2-1546209-4	2-796644-4	2-796700-4	2-796645-4	—
25	125.0 [4.921]	2-1546209-5	2-796644-5	2-796700-5	2-796645-5	—

Note: RDI Terminal Block Series 2EHDR-xx has been replaced with 796644-xx (green) and 796645-xx (black). BUCHANAN Terminal Block Series B73N4HxxT has been replaced with 796700-xx (blue) and 796645-xx (black).

*Wave solder process capable to 265°C [509°F] for 10 seconds. Dimensions may vary from what is shown for High Temperature Parts. Please check Customer Drawing.

Note: All part numbers are RoHS Compliant.

Two-Piece Terminal Block Connectors (Continued)

Right-Angle, Open End Stacking Headers, 5.08 mm Centerline Color – See chart.

UL Rating – 300 V, 15 A

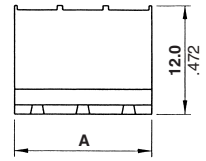
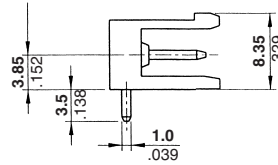
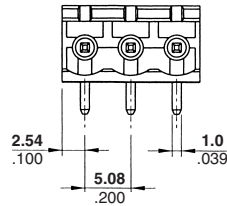
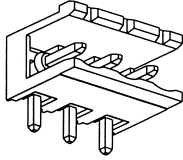

Recommended PC Board Layout

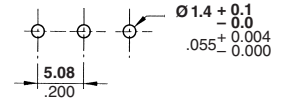

No. of Positions	Dim. A	Part Numbers		
		Green	Gray	Black*
2	10.16 [0.40]	282815-2	1546110-2	1776141-2
3	15.24 [0.60]	282815-3	1546110-3	1776141-3
4	20.32 [0.80]	282815-4	1546110-4	1776141-4
5	25.40 [1.00]	282815-5	1546110-5	1776141-5
6	30.48 [1.20]	282815-6	1546110-6	1776141-6
7	35.56 [1.40]	282815-7	1546110-7	1776141-7
8	40.64 [1.60]	282815-8	1546110-8	1776141-8
9	45.72 [1.80]	282815-9	1546110-9	—
10	50.80 [2.00]	1-282815-0	1-1546110-0	—
11	55.88 [2.20]	1-282815-1	1-1546110-1	—
12	60.96 [2.40]	1-282815-2	1-1546110-2	—
13	66.04 [2.60]	1-282815-3	1-1546110-3	—

No. of Positions	Dim. A	Part Numbers		
		Green	Gray	Black*
14	71.12 [2.80]	1-282815-4	1-1546110-4	—
15	76.20 [3.00]	1-282815-5	1-1546110-5	—
16	81.28 [3.20]	1-282815-6	1-1546110-6	—
17	86.36 [3.40]	1-282815-7	1-1546110-7	—
18	91.44 [3.60]	1-282815-8	1-1546110-8	—
19	96.52 [3.80]	1-282815-9	1-1546110-9	—
20	101.60 [4.00]	2-282815-0	2-1546110-0	—
21	106.68 [4.20]	2-282815-1	2-1546110-1	—
22	111.76 [4.40]	2-282815-2	2-1546110-2	—
23	116.84 [4.60]	2-282815-3	2-1546110-3	—
24	121.92 [4.80]	2-282815-4	2-1546110-4	—
25	127.00 [5.00]	2-282815-5	2-1546110-5	—

*Wave solder process capable to 265°C [509°F] for 10 seconds. Dimensions may vary from what is shown for High Temperature Parts. Please check Customer Drawing.

Right-Angle, Closed End Headers, 5.08 mm Centerline Color – See chart.

UL Rating – 300 V, 15 A

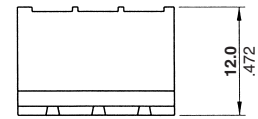
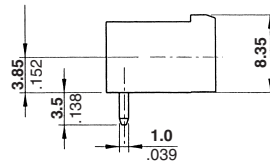
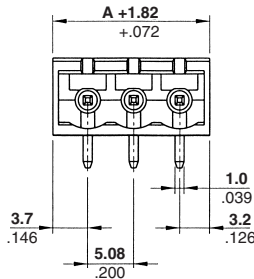
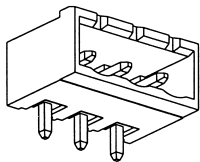

Recommended PC Board Layout

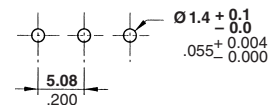

No. of Pos.	Dim. A	Part Numbers			
		Gray	Green	Black	Black*
2	10.16 [0.40]	1546109-2	796638-2	796639-2	1776038-2
3	15.24 [0.60]	1546109-3	796638-3	796639-3	1776038-3
4	20.32 [0.80]	1546109-4	796638-4	796639-4	1776038-4
5	25.40 [1.00]	1546109-5	796638-5	796639-5	1776038-5
6	30.48 [1.20]	1546109-6	796638-6	796639-6	1776038-6
7	35.56 [1.40]	1546109-7	796638-7	796639-7	1776038-7
8	40.64 [1.60]	1546109-8	796638-8	796639-8	1776038-8
9	45.72 [1.80]	1546109-9	796638-9	796639-9	—
10	50.80 [2.00]	1-1546109-0	1-796638-0	1-796639-0	—
11	55.88 [2.20]	1-1546109-1	1-796638-1	1-796639-1	—
12	60.96 [2.40]	1-1546109-2	1-796638-2	1-796639-2	—
13	66.04 [2.60]	1-1546109-3	1-796638-3	1-796639-3	—

No. of Positions	Dim. A	Part Numbers		
		Gray	Green	Black
14	71.12 [2.80]	1-1546109-4	1-796638-4	1-796639-4
15	76.20 [3.00]	1-1546109-5	1-796638-5	1-796639-5
16	81.28 [3.20]	1-1546109-6	1-796638-6	1-796639-6
17	86.36 [3.40]	1-1546109-7	1-796638-7	1-796639-7
18	91.44 [3.60]	1-1546109-8	1-796638-8	1-796639-8
19	96.52 [3.80]	1-1546109-9	1-796638-9	1-796639-9
20	101.60 [4.00]	2-1546109-0	2-796638-0	2-796639-0
21	106.68 [4.20]	2-1546109-1	2-796638-1	2-796639-1
22	111.76 [4.40]	2-1546109-2	2-796638-2	2-796639-2
23	116.84 [4.60]	2-1546109-3	2-796638-3	2-796639-3
24	121.92 [4.80]	2-1546109-4	2-796638-4	2-796639-4
25	127.00 [5.00]	2-1546109-5	2-796638-5	2-796639-5

Note: RDI Terminal Block Series 2EHDR-xx has been superceded/replaced with 796638-xx (green) and 796639-xx (black).

*Wave solder process capable to 265°C [509°F] for 10 seconds. Dimensions may vary from what is shown for High Temperature Parts. Please check Customer Drawing.

Note: All part numbers are RoHS Compliant.

Two-Piece Terminal Block Connectors (Continued)

**Right-Angle,
Open End Headers,
7.5 mm Centerline
Color – Green**

UL Rating – 300 V, 15 A

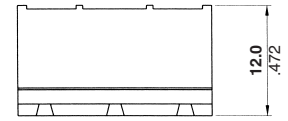
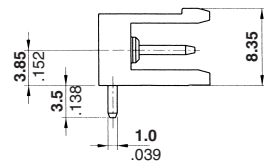
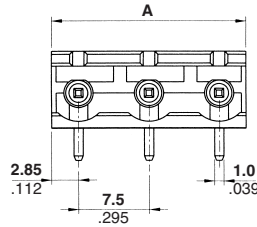
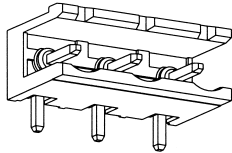

Recommended PC Board Layout

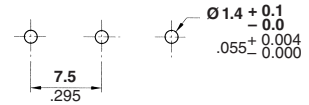

No. of Positions	Dim. A	Part Numbers
2	13.2 [0.520]	282961-2
3	20.7 [0.815]	282961-3
4	28.2 [1.110]	282961-4
5	35.7 [1.406]	282961-5
6	43.2 [1.701]	282961-6
7	50.7 [1.996]	282961-7

No. of Positions	Dim. A	Part Numbers
8	58.2 [2.291]	282961-8
9	65.7 [2.587]	282961-9
10	73.2 [2.882]	1-282961-0
11	80.7 [3.177]	1-282961-1
12	88.2 [3.472]	1-282961-2

**Right-Angle,
Closed End Headers,
7.5 mm Centerline
Color – Green**

UL Rating – 300 V, 15 A

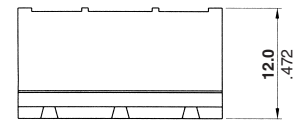
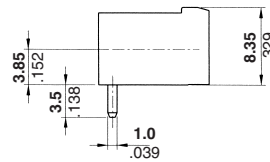
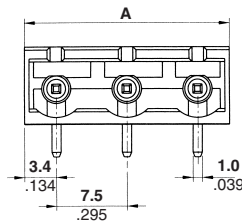
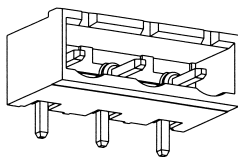

Recommended PC Board Layout

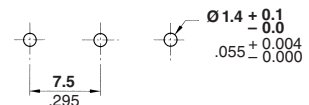

No. of Positions	Dim. A	Part Numbers
2	14.3 [0.563]	282962-2
3	21.8 [0.858]	282962-3
4	29.3 [1.154]	282962-4
5	36.8 [1.449]	282962-5
6	44.3 [1.744]	282962-6
7	51.8 [2.039]	282962-7

No. of Positions	Dim. A	Part Numbers
8	59.3 [2.335]	282962-8
9	66.8 [2.630]	282962-9
10	74.3 [2.925]	1-282962-0
11	81.8 [3.220]	1-282962-1
12	89.3 [3.516]	1-282962-2

Note: All part numbers are RoHS Compliant.

Two-Piece Terminal Block Connectors (Continued)

Right-Angle, Open End Headers, 7.62 mm Centerline
UL Rating – 300 V, 15 A

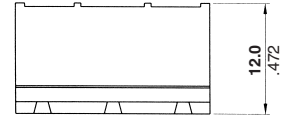
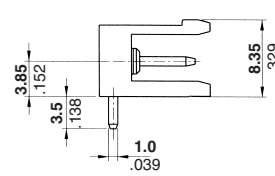
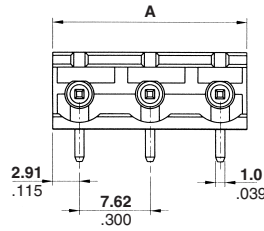
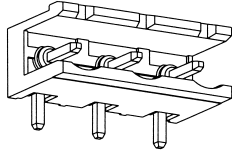

Recommended PC Board Layout

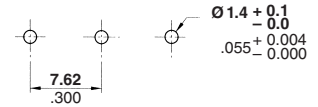

No. of Positions	Dim. A	Part Numbers	
		Green	Black*
2	13.44 [0.529]	282965-2	1776152-2
3	21.06 [0.829]	282965-3	1776152-3
4	28.68 [1.129]	282965-4	—
5	36.30 [1.429]	282965-5	—
6	43.92 [1.729]	282965-6	—
7	51.54 [2.029]	282965-7	—

*Wave solder process capable to 265°C [509°F] for 10 seconds
Dimensions may vary from what is shown for High Temperature Parts.
Please check Customer Drawing.

No. of Positions	Dim. A	Part Numbers	
		Green	Black*
8	59.16 [2.329]	282965-8	—
9	66.78 [2.629]	282965-9	—
10	74.40 [2.929]	1-282965-0	—
11	82.02 [3.229]	1-282965-1	—
12	89.64 [3.529]	1-282965-2	—

Right-Angle, Closed End Headers, 7.62 mm Centerline
UL Rating – 300 V, 15 A

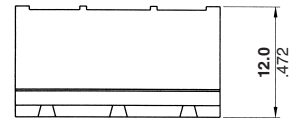
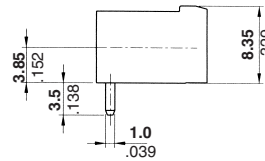
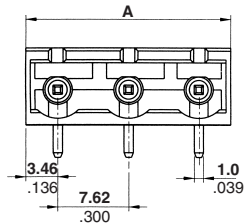
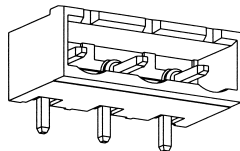

Recommended PC Board Layout

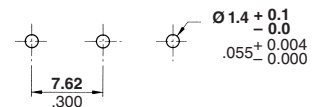

No. of Positions	Dim. A	Part Numbers	
		Green	Black*
2	14.44 [0.568]	282966-2	1776155-2
3	22.06 [0.868]	282966-3	1776155-3
4	29.68 [1.168]	282966-4	1776155-4
5	37.30 [1.468]	282966-5	1776155-5
6	44.92 [1.768]	282966-6	1776155-6
7	52.54 [2.068]	282966-7	1776155-7

*Wave solder process capable to 265°C [509°F] for 10 seconds
Dimensions may vary from what is shown for High Temperature Parts.
Please check Customer Drawing.

No. of Positions	Dim. A	Part Numbers	
		Green	Black*
8	60.16 [2.368]	282966-8	1776155-8
9	67.78 [2.668]	282966-9	1776155-9
10	75.40 [2.968]	1-282966-0	1-1776155-0
11	83.02 [3.268]	1-282966-1	1-1776155-1
12	90.64 [3.568]	1-282966-2	1-1776155-2

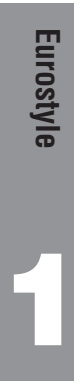

Note: All part numbers are RoHS Compliant.

Two-Piece Terminal Block Connectors (Continued)

Right-Angle, Open End Headers, 10.0 mm Centerline
UL Rating – 600 V, 15 A

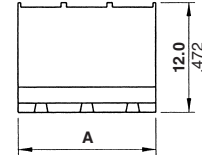
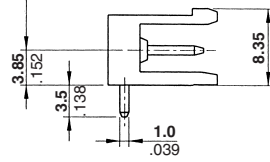
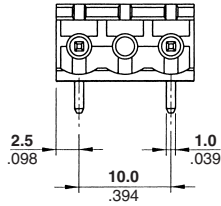
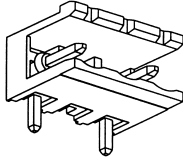

Recommended PC Board Layout

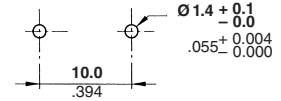

No. of Positions	Dim. A	Part Numbers	
		Green	Black*
2	15.0 [0.591]	282817-2	1776158-2
3	25.0 [0.984]	282817-3	1776158-3
4	35.0 [1.378]	282817-4	1776158-4
5	45.0 [1.772]	282817-5	—
6	55.0 [2.165]	282817-6	—
7	65.0 [2.559]	282817-7	—

No. of Positions	Dim. A	Part Numbers	
		Green	Black*
8	75.0 [2.953]	282817-8	—
9	85.0 [3.346]	282817-9	—
10	95.0 [3.740]	1-282817-0	—
11	105.0 [4.134]	1-282817-1	—
12	115.0 [4.528]	1-282817-2	—
13	125.0 [4.921]	1-282817-3	—

*Wave solder process capable to 265°C [509°F] for 10 seconds. Dimensions may vary from what is shown for High Temperature Parts. Please check Customer Drawing.

Right-Angle, Closed End Headers, 10.0 mm Centerline
UL Rating – 600 V, 15 A

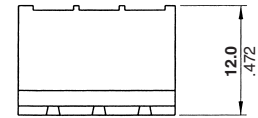
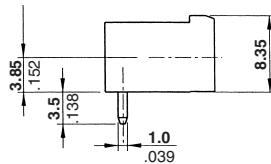
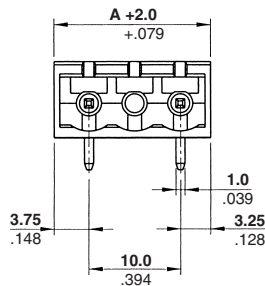
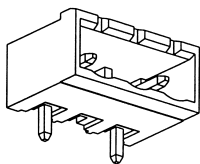

Recommended PC Board Layout

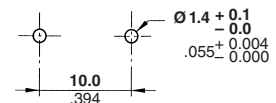

No. of Positions	Dim. A	Part Numbers	
		Green	Black*
2	15.0 [0.591]	282816-2	1776162-2
3	25.0 [0.984]	282816-3	1776162-3
4	35.0 [1.378]	282816-4	1776162-4
5	45.0 [1.772]	282816-5	—
6	55.0 [2.165]	282816-6	—
7	65.0 [2.559]	282816-7	—

No. of Positions	Dim. A	Part Numbers	
		Green	Black*
8	75.0 [2.953]	282816-8	—
9	85.0 [3.346]	282816-9	—
10	95.0 [3.740]	1-282816-0	—
11	105.0 [4.134]	1-282816-1	—
12	115.0 [4.528]	1-282816-2	—
13	125.0 [4.921]	1-282816-3	—

*Wave solder process capable to 265°C [509°F] for 10 seconds. Dimensions may vary from what is shown for High Temperature Parts. Please check Customer Drawing.

Note: All part numbers are RoHS Compliant.

Two-Piece Terminal Block Connectors (Continued)

Right-Angle, Open End Headers, 10.16 mm Centerline
UL Rating – 600 V, 15 A

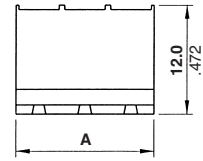
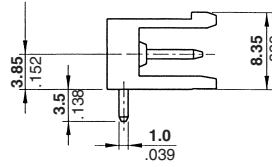
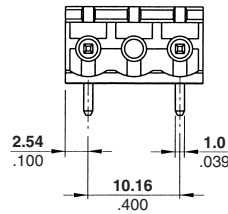
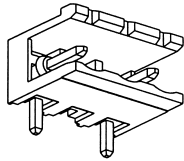

Recommended PC Board Layout

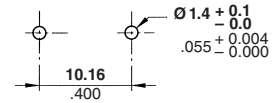

No. of Positions	Dim. A	Part Numbers	
		Green	Black*
2	15.24 [0.60]	282819-2	1776159-2
3	25.40 [1.00]	282819-3	1776159-3
4	35.56 [1.40]	282819-4	1776159-4
5	45.72 [1.80]	282819-5	—
6	55.88 [2.20]	282819-6	—
7	66.04 [2.60]	282819-7	—

No. of Positions	Dim. A	Part Numbers	
		Green	Black*
8	76.20 [3.00]	282819-8	—
9	86.36 [3.40]	282819-9	—
10	96.52 [3.80]	1-282819-0	—
11	106.68 [4.20]	1-282819-1	—
12	116.84 [4.60]	1-282819-2	—
13	127.00 [5.00]	1-282819-3	—

*Wave solder process capable to 265°C [509°F] for 10 seconds. Dimensions may vary from what is shown for High Temperature Parts. Please check Customer Drawing.

Right-Angle, Closed End Headers, 10.16 mm Centerline
UL Rating – 600 V, 15 A

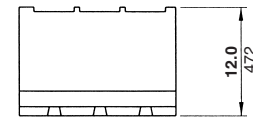
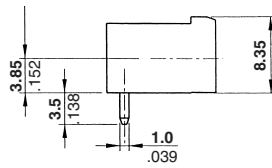
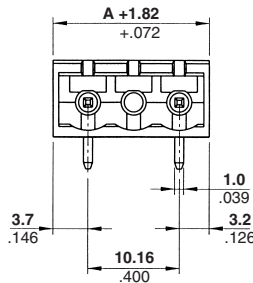
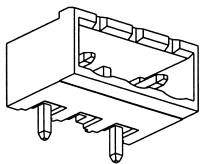

Recommended PC Board Layout

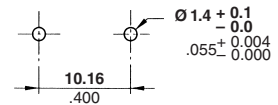

No. of Positions	Dim. A	Part Numbers	
		Green	Black*
2	15.24 [0.60]	282818-2	1776163-2
3	25.40 [1.00]	282818-3	1776163-3
4	35.56 [1.40]	282818-4	1776163-4
5	45.72 [1.80]	282818-5	—
6	55.88 [2.20]	282818-6	—
7	66.04 [2.60]	282818-7	—

No. of Positions	Dim. A	Part Numbers	
		Green	Black*
8	76.20 [3.00]	282818-8	—
9	86.36 [3.40]	282818-9	—
10	96.52 [3.80]	1-282818-0	—
11	106.68 [4.20]	1-282818-1	—
12	116.84 [4.60]	1-282818-2	—
13	127.00 [5.00]	1-282818-3	—

*Wave solder process capable to 265°C [509°F] for 10 seconds. Dimensions may vary from what is shown for High Temperature Parts. Please check Customer Drawing.



Note: All part numbers are RoHS Compliant.

Two-Piece Terminal Block Connectors (Continued)

Right-Angle, Open End Stacking Headers with Interlock, 5.0 mm Centerline
UL Rating – 300 V, 15 A

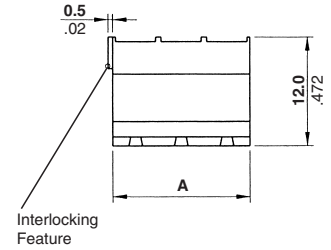
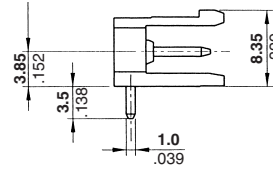
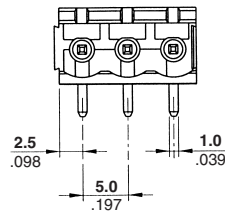
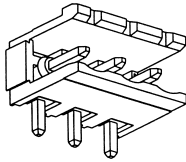

Recommended PC Board Layout

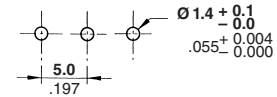

No. of Positions	Dim. A	Part Numbers	
		Green	Black*
2	10.0 [.394]	282811-2	1776144-2
3	15.0 [.591]	282811-3	1776144-3
4	20.0 [.787]	282811-4	1776144-4

*Wave solder process capable to 265°C [509°F] for 10 seconds
 Dimensions may vary from what is shown for High Temperature Parts.
 Please check Customer Drawing.

Right-Angle, Open End Stacking Headers with Interlock, 5.08 mm Centerline
UL Rating – 300 V, 15 A

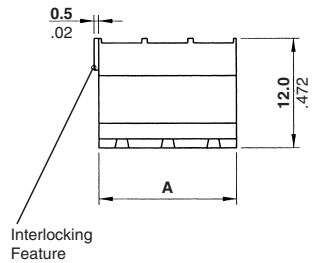
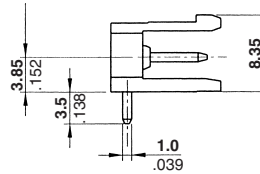
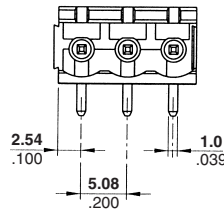
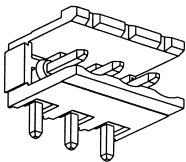

Recommended PC Board Layout

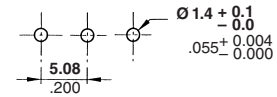

No. of Positions	Dim. A	Part Numbers	
		Green	Black*
2	10.16 [.400]	282814-2	1776145-2
3	15.24 [.600]	282814-3	1776145-3
4	20.32 [.800]	282814-4	1776145-4

*Wave solder process capable to 265°C [509°F] for 10 seconds
 Dimensions may vary from what is shown for High Temperature Parts.
 Please check Customer Drawing.

Note: All part numbers are RoHS Compliant.

Two-Piece Terminal Block Connectors (Continued)

**Right-Angle,
Closed End Headers,
w/Ejectors,
5.08 mm Centerline
Color – Green**
UL Rating – 300 V, 15 A

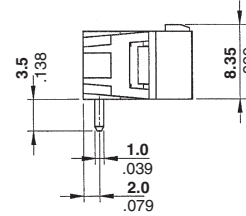
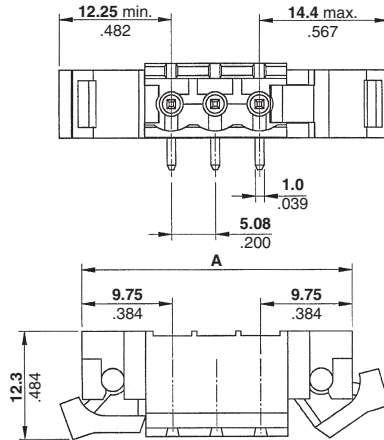
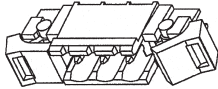

Recommended PC Board Layout

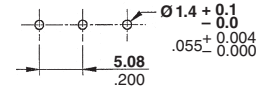

No. of Positions	Dim. A	Part Numbers
2	24.58 [.968]	284008-2
3	29.66 [1.168]	284008-3
4	34.74 [1.368]	284008-4
5	39.82 [1.568]	284008-5
6	44.90 [1.768]	284008-6
7	49.98 [1.968]	284008-7
8	55.06 [2.168]	284008-8
9	60.14 [2.368]	284008-9
10	65.22 [2.568]	1-284008-0
11	70.30 [2.768]	1-284008-1

No. of Positions	Dim. A	Part Numbers
12	75.38 [2.968]	1-284008-2
13	80.46 [3.168]	1-284008-3
14	85.54 [3.368]	1-284008-4
15	90.62 [3.568]	1-284008-5
16	95.70 [3.768]	1-284008-6
17	100.78 [3.968]	1-284008-7
18	105.86 [4.168]	1-284008-8
19	110.94 [4.368]	1-284008-9
20	116.02 [4.568]	2-284008-0
21	121.10 [4.768]	2-284008-1

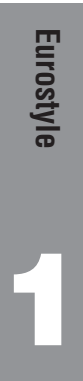

Note: All part numbers are RoHS Compliant.

Two-Piece Terminal Block Connectors (Continued)

Vertical, Closed End Double-Row Header
5.0 mm Centerline
Color – See chart.
UL Rating – 300 V, 12 A

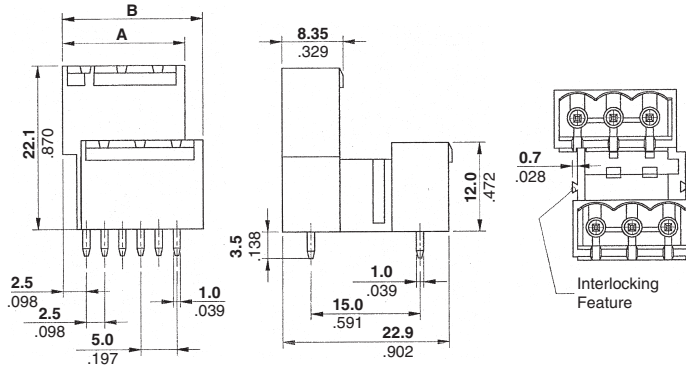
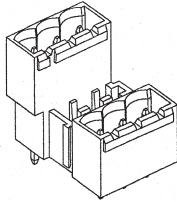

Recommended PC Board Layout

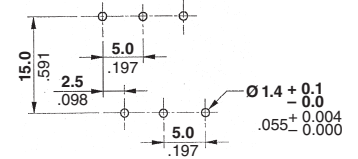

No. of Positions	Dimensions		Part Numbers		
	A	B	Green	Gray	Black*
2	12.0 [0.472]	14.5 [0.571]	284056-2	1546106-2	1776164-2
3	17.0 [0.669]	19.5 [0.768]	284056-3	1546106-3	1776164-3
4	22.0 [0.866]	24.5 [0.965]	284056-4	1546106-4	1776164-4
5	27.0 [1.063]	29.5 [1.161]	284056-5	1546106-5	1776164-5
6	32.0 [1.260]	34.5 [1.358]	284056-6	1546106-6	1776164-6
7	37.0 [1.457]	39.5 [1.555]	284056-7	1546106-7	1776164-7
8	42.0 [1.654]	44.5 [1.752]	284056-8	1546106-8	1776164-8
9	47.0 [1.850]	49.5 [1.949]	284056-9	1546106-9	—
10	52.0 [2.047]	54.5 [2.146]	284056-10	1-1546106-0	—
11	57.0 [2.244]	59.5 [2.343]	284056-11	1-1546106-1	—
12	62.0 [2.441]	64.5 [2.539]	284056-12	1-1546106-2	—
13	67.0 [2.638]	69.5 [2.736]	284056-13	1-1546106-3	—

*Wave solder process capable to 265°C [509°F] for 10 seconds

No. of Positions	Dimensions		Part Numbers		
	A	B	Green	Gray	Black*
14	72.0 [2.835]	74.5 [2.933]	284056-14	1-1546106-4	—
15	77.0 [3.031]	79.5 [3.130]	284056-15	1-1546106-5	—
16	82.0 [3.228]	84.5 [3.327]	284056-16	1-1546106-6	—
17	87.0 [3.425]	89.5 [3.524]	284056-17	1-1546106-7	—
18	92.0 [3.622]	94.5 [3.720]	284056-18	1-1546106-8	—
19	97.0 [3.819]	99.5 [3.917]	284056-19	1-1546106-9	—
20	102.0 [4.016]	104.5 [4.114]	284056-20	2-1546106-0	—
21	107.0 [4.213]	109.5 [4.311]	284056-21	2-1546106-1	—
22	112.0 [4.409]	114.5 [4.508]	284056-22	2-1546106-2	—
23	117.0 [4.606]	119.5 [4.705]	284056-23	2-1546106-3	—
24	122.0 [4.803]	124.5 [4.902]	284056-24	2-1546106-4	—
25	127.0 [5.000]	129.5 [5.098]	284056-25	2-1546106-5	—

Vertical, Closed End Double-Row Header
5.08 mm Centerline
UL Rating – 300 V, 12 A

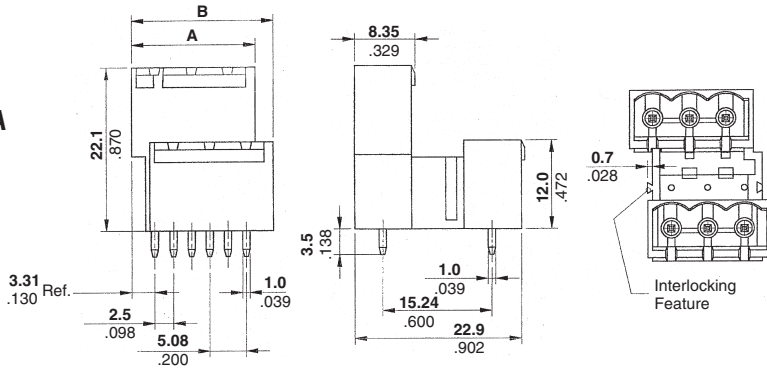
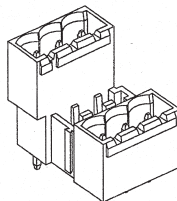

Recommended PC Board Layout

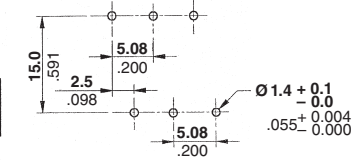

No. of Positions	Dim.		Part Numbers	
	A	B	Green	Black*
2	12.20 [0.48]	14.74 [0.58]	284065-2	1776165-2
3	17.28 [0.68]	19.82 [0.78]	284065-3	1776165-3
4	22.36 [0.88]	24.90 [0.98]	284065-4	1776165-4
5	27.44 [1.08]	29.98 [1.18]	284065-5	1776165-5
6	32.52 [1.28]	35.06 [1.38]	284065-6	1776165-6
7	37.60 [1.48]	40.14 [1.58]	284065-7	1776165-7
8	42.68 [1.68]	45.22 [1.78]	284065-8	1776165-8
9	47.76 [1.88]	50.30 [1.98]	284065-9	—
10	52.84 [2.08]	55.38 [2.18]	1-284065-0	—
11	57.92 [2.28]	60.46 [2.68]	1-284065-1	—
12	63.00 [2.48]	65.54 [2.58]	1-284065-2	—
13	68.08 [2.68]	70.62 [2.78]	1-284065-3	—

*Wave solder process capable to 265°C [509°F] for 10 seconds

No. of Positions	Dim.		Part Numbers	
	A	B	Green	Black*
14	72.0 [2.835]	74.5 [2.933]	1-284065-4	—
15	77.0 [3.031]	79.5 [3.130]	1-284065-5	—
16	82.0 [3.228]	84.5 [3.327]	1-284065-6	—
17	87.0 [3.425]	89.5 [3.524]	1-284065-7	—
18	92.0 [3.622]	94.5 [3.720]	1-284065-8	—
19	97.0 [3.819]	99.5 [3.917]	1-284065-9	—
20	102.0 [4.016]	104.5 [4.114]	2-284065-0	—
21	107.0 [4.213]	109.5 [4.311]	2-284065-1	—
22	112.0 [4.409]	114.5 [4.508]	2-284065-2	—
23	117.0 [4.606]	119.5 [4.705]	2-284065-3	—
24	122.0 [4.803]	124.5 [4.902]	2-284065-4	—
25	127.0 [5.000]	129.5 [5.098]	2-284065-5	—

Note: All part numbers are RoHS Compliant.

Two-Piece Terminal Block Connectors (Continued)

Vertical, Closed End Double-Row Header
10.0 mm Centerline
Color – Black
UL Rating – 600 V, 12 A

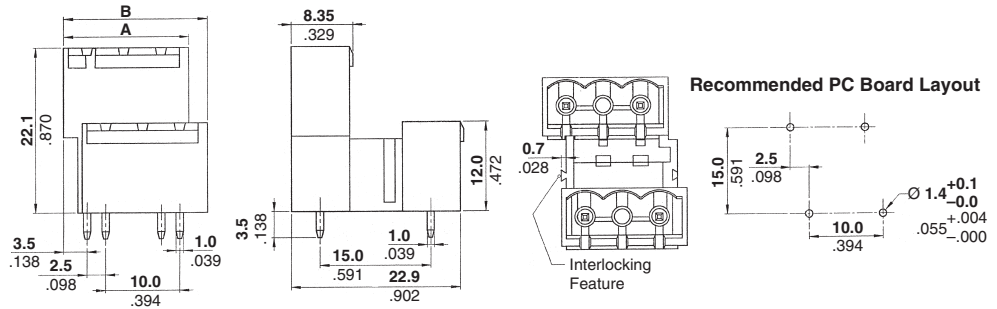
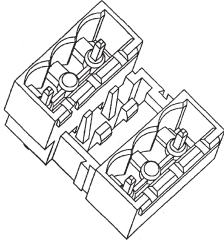

No. of Positions	Dim.		Part Numbers*
	A	B	
2	17.0 [0.669]	19.5 [0.768]	1776168-2
3	27.0 [1.063]	29.5 [1.161]	1776168-3
4	37.0 [1.457]	39.5 [1.555]	1776168-4

*Wave solder process capable to 265°C [509°F] for 10 seconds

Vertical, Closed End Double-Row Header
10.16 mm Centerline
Color – Black
UL Rating – 600 V, 12 A

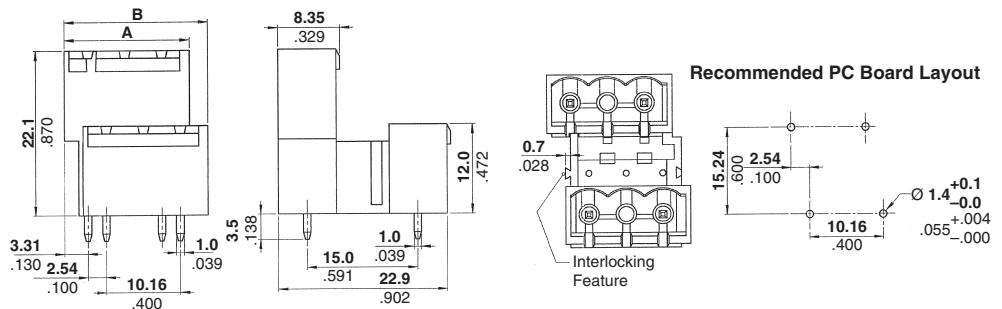
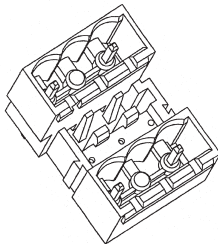

No. of Positions	Dim.		Part Numbers*
	A	B	
2	17.28 [0.68]	19.82 [0.78]	1776169-2
3	27.44 [1.08]	29.98 [1.18]	1776169-3
4	37.60 [1.48]	40.14 [1.58]	1776169-4

*Wave solder process capable to 265°C [509°F] for 10 seconds

Note: All part numbers are RoHS Compliant.

Two-Piece Terminal Block Connectors (Continued)

Right-Angle, Open End Double-Row Header w/Interlock, 5.0 mm Centerline Color – Green
UL Rating – 300 V, 12 A

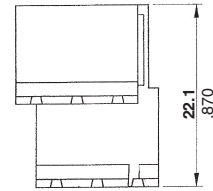
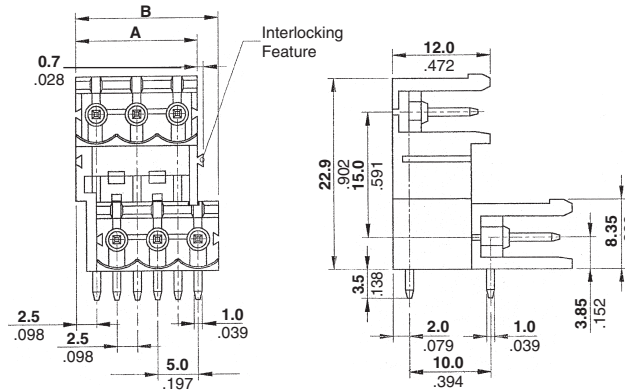
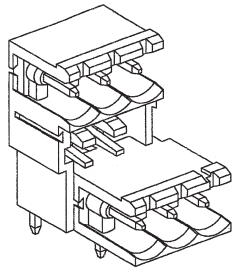

Recommended PC Board Layout

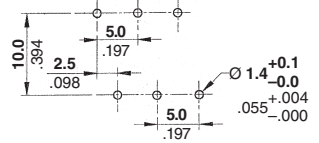

No. of Positions	Dim.		Part Numbers
	A	B	
2	10.0 [.394]	12.5 [.492]	284052-2
3	15.0 [.591]	17.5 [.689]	284052-3

Right-Angle, Open End Double-Row Header w/Interlock, 5.08 mm Centerline Color – See chart.
UL Rating – 300 V, 12 A

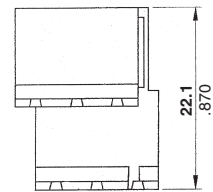
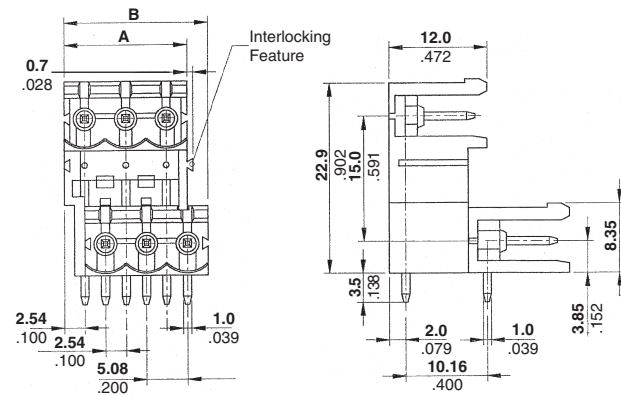
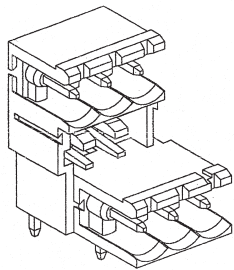

Recommended PC Board Layout

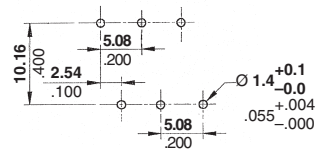

No. of Positions	Dim.		Part Numbers	
	A	B	Green	Gray
2	10.16 [.400]	12.70 [.500]	284053-2	1546237-2
3	15.24 [.600]	17.78 [.700]	284053-3	1546237-3

Note: All part numbers are RoHS Compliant.

Two-Piece Terminal Block Connectors (Continued)

Right-Angle, Closed End Double-Row Header w/Interlock, 5.0 mm Centerline Color – Black
UL Rating – 300 V, 12 A

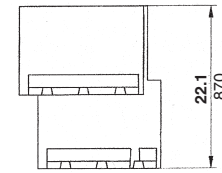
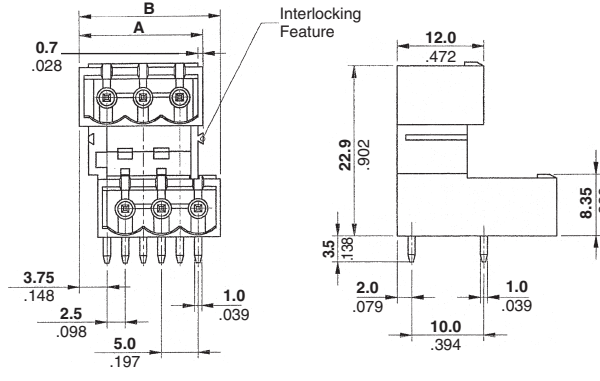
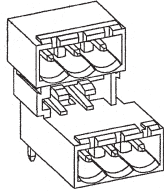

Recommended PC Board Layout

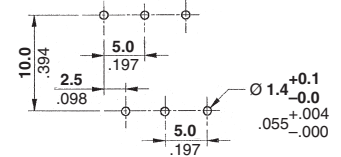

No. of Positions	Dim.		Part Numbers*
	A	B	
2	12.0 [0.472]	14.5 [0.571]	1776166-2
3	17.0 [0.669]	19.5 [0.768]	1776166-3
4	22.0 [0.866]	24.5 [0.965]	1776166-4
5	27.0 [1.063]	29.5 [1.161]	1776166-5
6	32.0 [1.260]	34.5 [1.358]	1776166-6
7	37.0 [1.457]	39.5 [1.555]	1776166-7
8	42.0 [1.654]	44.5 [1.752]	1776166-8

*Wave solder process capable to 265°C [509°F] for 10 seconds

Right-Angle, Closed End Double-Row Header w/Interlock, 5.08 mm Centerline
UL Rating – 300 V, 12 A

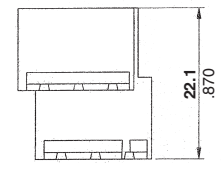
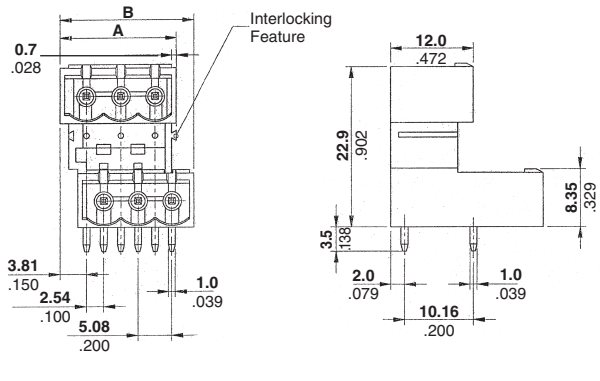
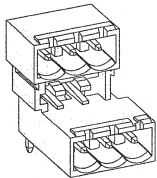

Recommended PC Board Layout

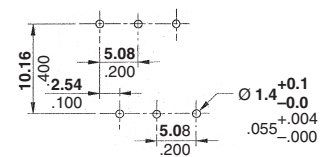

No. of Positions	Dim.		Part Numbers	
	A	B	Green	Black*
2	12.20 [0.48]	14.74 [0.58]	284061-2	1776167-2
3	17.28 [0.68]	19.82 [0.78]	284061-3	1776167-3
4	22.36 [0.88]	24.90 [0.98]	284061-4	1776167-4
5	27.44 [1.08]	29.98 [1.18]	284061-5	1776167-5
6	32.52 [1.28]	35.06 [1.38]	284061-6	1776167-6
7	37.60 [1.48]	40.14 [1.58]	284061-7	1776167-7
8	42.68 [1.68]	45.22 [1.78]	284061-8	1776167-8
9	47.76 [1.88]	50.30 [1.98]	284061-9	—
10	52.84 [2.08]	55.38 [2.18]	1-284061-0	—
11	57.92 [2.28]	60.46 [2.68]	1-284061-1	—
12	63.00 [2.48]	65.54 [2.58]	1-284061-2	—
13	68.08 [2.68]	70.62 [2.78]	1-284061-3	—

*Wave solder process capable to 265°C [509°F] for 10 seconds

No. of Positions	Dim.		Part Numbers	
	A	B	Green	Black*
14	73.16 [2.88]	75.70 [2.98]	1-284061-4	—
15	78.24 [3.08]	80.78 [3.18]	1-284061-5	—
16	83.32 [3.28]	85.86 [3.38]	1-284061-6	—
17	88.40 [3.48]	90.94 [3.58]	1-284061-7	—
18	93.48 [3.68]	96.02 [3.78]	1-284061-8	—
19	98.56 [3.88]	101.10 [3.98]	1-284061-9	—
20	103.64 [4.08]	106.18 [4.18]	2-284061-0	—
21	108.72 [4.48]	111.26 [4.38]	2-284061-1	—
22	113.80 [4.88]	116.34 [4.58]	2-284061-2	—
23	118.88 [4.68]	121.42 [4.78]	2-284061-3	—
24	123.96 [4.88]	126.50 [4.98]	2-284061-4	—
25	129.04 [5.08]	131.58 [5.18]	2-284061-5	—



Note: All part numbers are RoHS Compliant.

Two-Piece Terminal Block Connectors (Continued)

Right-Angle, Closed End Double-Row Header w/Interlock, 10.0 mm Centerline Color – Black
UL Rating – 600 V, 12 A

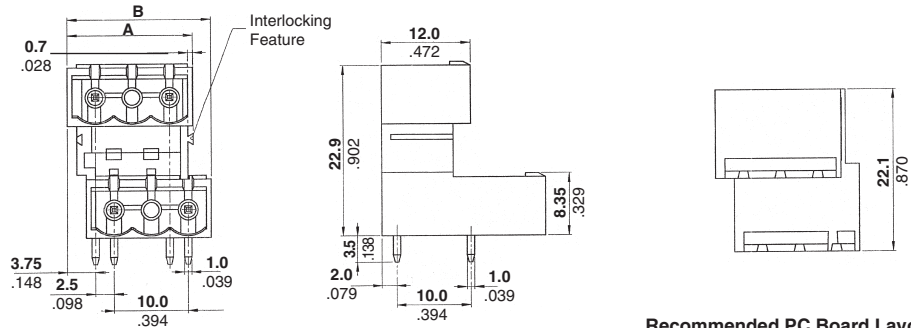
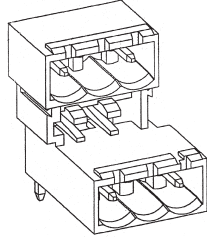

Recommended PC Board Layout

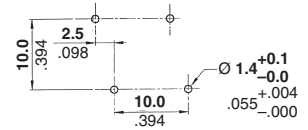

No. of Positions	Dim.		Part Numbers*
	A	B	
2	17.0 [0.669]	19.5 [0.768]	1776170-2
3	27.0 [1.063]	29.5 [1.161]	1776170-3
4	37.0 [1.457]	39.5 [1.555]	1776170-4

*Wave solder process capable to 265°C [509°F] for 10 seconds

Right-Angle, Closed End Double-Row Header w/Interlock, 10.16 mm Centerline Color – Black
UL Rating – 600 V, 12 A

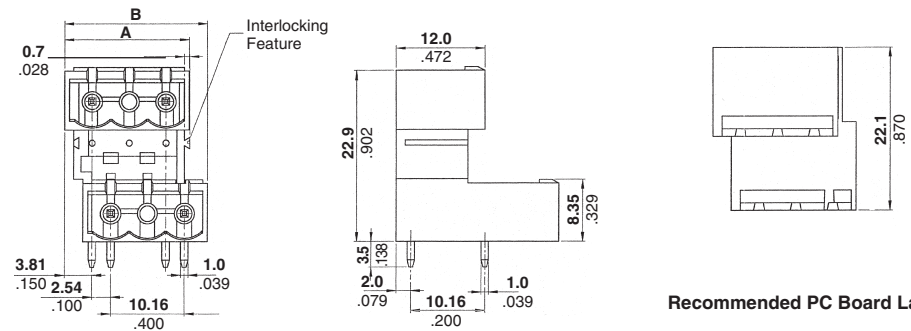
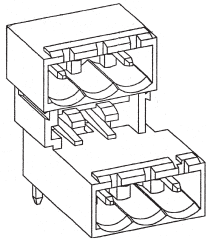

Recommended PC Board Layout

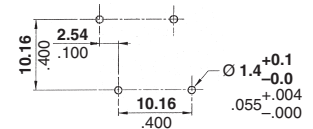

No. of Positions	Dim.		Part Numbers*
	A	B	
2	17.28 [0.68]	19.82 [0.78]	1776171-2
3	27.44 [1.08]	29.98 [1.18]	1776171-3
4	37.60 [1.48]	40.14 [1.58]	1776171-4

*Wave solder process capable to 265°C [509°F] for 10 seconds

Note: All part numbers are RoHS Compliant.

Two-Piece Terminal Block Connectors (Continued)

Plug, Right-Angle w/Screw Flange
3.5 mm Centerline
Color – Green
UL Rating – 300 V, 11 A
14-30 AWG

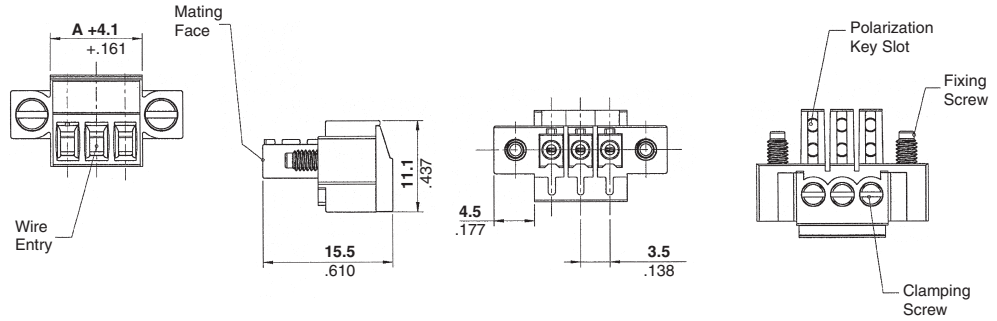
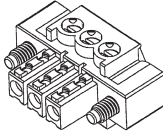

Suggested Screw Torque—
 2.7 in.-lb.

No. of Positions	Dim. A	Part Numbers
2	3.5 [0.138]	284510-2
3	7.0 [0.276]	284510-3
4	10.5 [0.413]	284510-4
5	14.0 [0.551]	284510-5
6	17.5 [0.689]	284510-6
7	21.0 [0.827]	284510-7
8	24.5 [0.965]	284510-8
9	28.0 [1.102]	284510-9
10	31.5 [1.240]	1-284510-0
11	35.0 [1.378]	1-284510-1
12	38.5 [1.516]	1-284510-2

No. of Positions	Dim. A	Part Numbers
13	42.0 [1.654]	1-284510-3
14	45.5 [1.791]	1-284510-4
15	49.0 [1.929]	1-284510-5
16	52.5 [2.067]	1-284510-6
17	56.0 [2.205]	1-284510-7
18	59.5 [2.343]	1-284510-8
19	63.0 [2.480]	1-284510-9
20	66.5 [2.618]	2-284510-0
21	70.0 [2.756]	2-284510-1
22	73.5 [2.894]	2-284510-2
23	77.0 [3.031]	2-284510-3

Plug, Right-Angle w/Screw Flange
3.81 mm Centerline
Color – Green
UL Rating – 300 V, 11 A
14-30 AWG

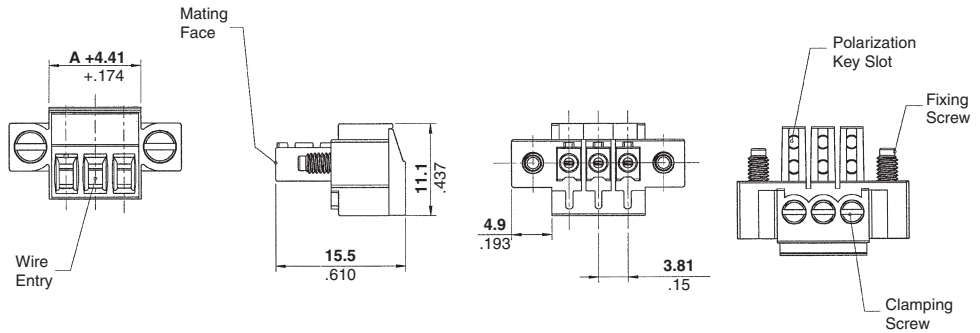
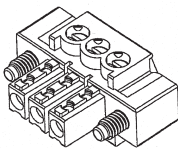

Suggested Screw Torque—
 2.7 in.-lb.

No. of Positions	Dim. A	Part Numbers
2	3.81 [0.15]	284511-2
3	7.62 [0.30]	284511-3
4	11.43 [0.45]	284511-4
5	15.24 [0.60]	284511-5
6	19.05 [0.75]	284511-6
7	22.86 [0.90]	284511-7
8	26.67 [1.05]	284511-8
9	30.48 [1.20]	284511-9
10	34.29 [1.35]	1-284511-0
11	38.10 [1.50]	1-284511-1
12	41.91 [1.65]	1-284511-2

No. of Positions	Dim. A	Part Numbers
13	45.72 [1.80]	1-284511-3
14	49.53 [1.95]	1-284511-4
15	53.34 [2.10]	1-284511-5
16	57.15 [2.25]	1-284511-6
17	60.96 [2.40]	1-284511-7
18	64.77 [2.55]	1-284511-8
19	68.58 [2.70]	1-284511-9
20	72.39 [2.85]	2-284511-0
21	76.20 [3.00]	2-284511-1
22	80.01 [3.15]	2-284511-2
23	83.82 [3.30]	2-284511-3



Note: All part numbers are RoHS Compliant.

Two-Piece Terminal Block Connectors (Continued)

Plug, Right-Angle w/Locking Screw Flange, 5.0 mm Centerline
Color – Green

UL Rating – 300 V, 15 A
12-30 AWG

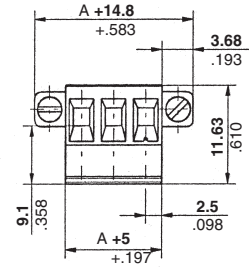
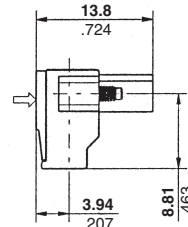
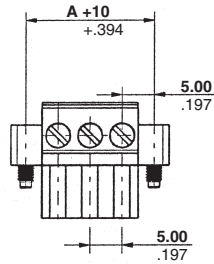
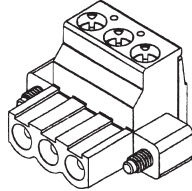

Suggested Screw Torque—
7.0 in.-lb.

No. of Positions	Dim. A	Part Numbers
2	5.0 [0.197]	796858-2
3	10.0 [0.394]	796858-3
4	15.0 [0.591]	796858-4
5	20.0 [0.787]	796858-5
6	25.0 [0.984]	796858-6
7	30.0 [1.181]	796858-7
8	35.0 [1.378]	796858-8

Plug, Right-Angle w/Locking Screw Flange, 5.08 mm Centerline
Color – Green

UL Rating – 300 V, 15 A
12-30 AWG

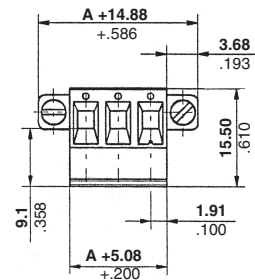
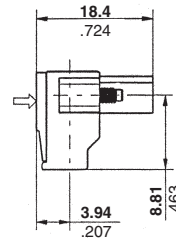
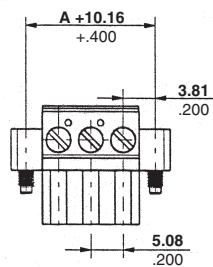
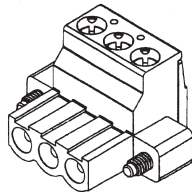

Suggested Screw Torque—
7.0 in.-lb.

No. of Positions	Dim. A	Part Numbers
2	5.08 [0.20]	796859-2
3	10.16 [0.40]	796859-3
4	15.24 [0.60]	796859-4
5	20.32 [0.80]	796859-5
6	25.40 [1.00]	796859-6
7	30.48 [1.20]	796859-7
8	35.56 [1.40]	796859-8
9	40.64 [1.60]	796859-9
10	45.72 [1.80]	1-796859-0
11	50.80 [2.00]	1-796859-1
12	55.88 [2.20]	1-796859-2

No. of Positions	Dim. A	Part Numbers
13	60.96 [2.40]	1-796859-3
14	66.04 [2.60]	1-796859-4
15	71.12 [2.80]	1-796859-5
16	76.20 [3.00]	1-796859-6
17	81.28 [3.20]	1-796859-7
18	86.36 [3.40]	1-796859-8
19	91.44 [3.60]	1-796859-9
20	96.52 [3.80]	2-796859-0
21	101.60 [4.00]	2-796859-1
22	106.68 [4.20]	2-796859-2
23	111.76 [4.40]	2-796859-3

Note: All part numbers are RoHS Compliant.

Two-Piece Terminal Block Connectors (Continued)

**Plug (Left-Hand Version),
Straight w/Locking Screw
Flange,
5.08 mm Centerline
Color – Green**

**UL Rating – 300 V, 15 A
12-30 AWG**

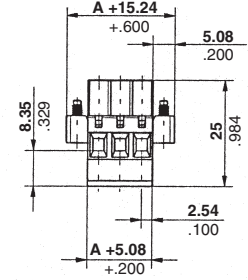
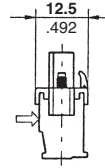
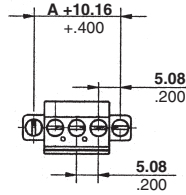
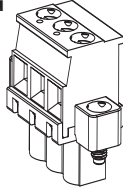

**Suggested Screw Torque—
7.0 in.-lb.**

No. of Positions	Dim. A	Part Numbers
2	5.08 [0.20]	796861-2
3	10.16 [0.40]	796861-3
4	15.24 [0.60]	796861-4
5	20.32 [0.80]	796861-5
6	25.40 [1.00]	796861-6
7	30.48 [1.20]	796861-7
8	35.56 [1.40]	796861-8
9	40.64 [1.60]	796861-9
10	45.72 [1.80]	1-796861-0
11	50.80 [2.00]	1-796861-1
12	55.88 [2.20]	1-796861-2

No. of Positions	Dim. A	Part Numbers
13	60.96 [2.40]	1-796861-3
14	66.04 [2.60]	1-796861-4
15	71.12 [2.80]	1-796861-5
16	76.20 [3.00]	1-796861-6
17	81.28 [3.20]	1-796861-7
18	86.36 [3.40]	1-796861-8
19	91.44 [3.60]	1-796861-9
20	96.52 [3.80]	2-796861-0
21	101.60 [4.00]	2-796861-1
22	106.68 [4.20]	2-796861-2
23	111.76 [4.40]	2-796861-3

**Plug (Right-Hand Version),
Straight w/Locking Screw
Flange,
5.08 mm Centerline
Color – Green**

**UL Rating – 300 V, 15 A
12-30 AWG**

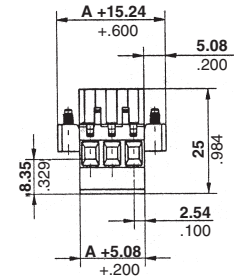
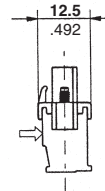
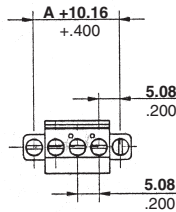
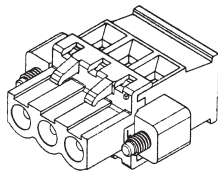

**Suggested Screw Torque—
7.0 in.-lb.**

No. of Positions	Dim. A	Part Numbers
2	5.08 [0.20]	796863-2
3	10.16 [0.40]	796863-3
4	15.24 [0.60]	796863-4
5	20.32 [0.80]	796863-5
6	25.40 [1.00]	796863-6
7	30.48 [1.20]	796863-7
8	35.56 [1.40]	796863-8
9	40.64 [1.60]	796863-9
10	45.72 [1.80]	1-796863-0
11	50.80 [2.00]	1-796863-1
12	55.88 [2.20]	1-796863-2

No. of Positions	Dim. A	Part Numbers
13	60.96 [2.40]	1-796863-3
14	66.04 [2.60]	1-796863-4
15	71.12 [2.80]	1-796863-5
16	76.20 [3.00]	1-796863-6
17	81.28 [3.20]	1-796863-7
18	86.36 [3.40]	1-796863-8
19	91.44 [3.60]	1-796863-9
20	96.52 [3.80]	2-796863-0
21	101.60 [4.00]	2-796863-1
22	106.68 [4.20]	2-796863-2
23	111.76 [4.40]	2-796863-3

Note: All part numbers are RoHS Compliant.

Two-Piece Terminal Block Connectors (Continued)

Plug, Right-Angle, 3.5 mm Centerline Colors – See chart.

UL Rating – 300 V, 11 A 14-30 AWG

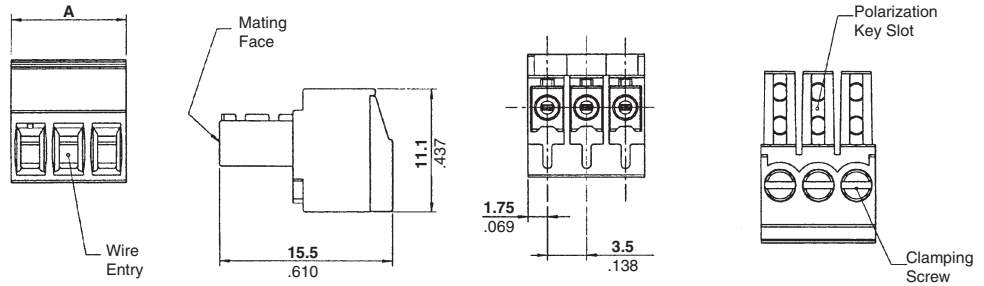
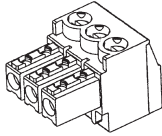

Suggested Screw Torque—2.7 in.-lb.

No. of Positions	Dim. A	Part Numbers	
		Green	Blue
2	7.0 [0.276]	284506-2	796693-2
3	10.5 [0.413]	284506-3	796693-3
4	14.0 [0.551]	284506-4	796693-4
5	17.5 [0.689]	284506-5	796693-5
6	21.0 [0.827]	284506-6	796693-6
7	24.5 [0.965]	284506-7	796693-7
8	28.0 [1.102]	284506-8	796693-8
9	31.5 [1.240]	284506-9	796693-9
10	35.0 [1.378]	1-284506-0	1-796693-0
11	38.5 [1.516]	1-284506-1	1-796693-1
12	42.0 [1.654]	1-284506-2	1-796693-2
13	45.5 [1.791]	1-284506-3	1-796693-3

No. of Positions	Dim. A	Part Numbers	
		Green	Blue
14	49.0 [1.929]	1-284506-4	1-796693-4
15	52.5 [2.067]	1-284506-5	1-796693-5
16	56.0 [2.205]	1-284506-6	1-796693-6
17	59.5 [2.343]	1-284506-7	1-796693-7
18	63.0 [2.450]	1-284506-8	1-796693-8
19	66.5 [2.618]	1-284506-9	1-796693-9
20	70.0 [2.756]	2-284506-0	2-796693-0
21	73.5 [2.894]	2-284506-1	2-796693-1
22	77.0 [3.031]	2-284506-2	2-796693-2
23	80.5 [3.169]	2-284506-3	2-796693-3
24	84.0 [3.307]	2-284506-4	2-796693-4
25	87.5 [3.445]	2-284506-5	2-796693-5

Note: BUCHANAN Terminal Block Series B52C3UxxT has been superseded/replaced with 796693-xx (blue).

Plug, Right-Angle, 3.81 mm Centerline Color – Green

UL Rating – 300 V, 11 A 14-30 AWG

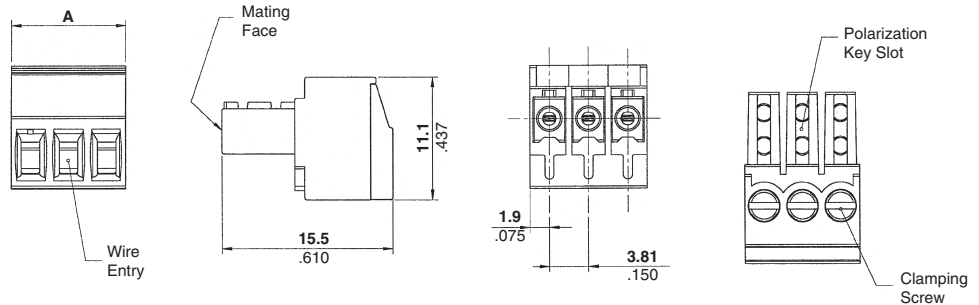
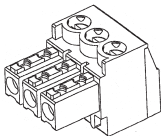

Suggested Screw Torque—2.7 in.-lb.

No. of Positions	Dim. A	Part Numbers
2	7.62 [0.30]	284507-2
3	11.43 [0.45]	284507-3
4	15.24 [0.60]	284507-4
5	19.05 [0.75]	284507-5
6	22.86 [0.90]	284507-6
7	26.67 [1.05]	284507-7
8	30.48 [1.20]	284507-8
9	34.29 [1.35]	284507-9
10	38.10 [1.50]	1-284507-0
11	41.91 [1.65]	1-284507-1
12	45.72 [1.80]	1-284507-2
13	49.53 [1.95]	1-284507-3

No. of Positions	Dim. A	Part Numbers
14	53.34 [2.10]	1-284507-4
15	57.15 [2.25]	1-284507-5
16	60.96 [2.40]	1-284507-6
17	64.77 [2.55]	1-284507-7
18	68.58 [2.70]	1-284507-8
19	72.39 [2.85]	1-284507-9
20	76.20 [3.00]	2-284507-0
21	80.01 [3.15]	2-284507-1
22	83.82 [3.30]	2-284507-2
23	87.63 [3.45]	2-284507-3
24	91.44 [3.60]	2-284507-4
25	95.25 [3.75]	2-284507-5

Note: All part numbers are RoHS Compliant.

Two-Piece Terminal Block Connectors (Continued)

Plug, Right-Angle, 5.0 mm Centerline Colors – See chart.

UL Rating – 300 V, 15 A 12-30 AWG

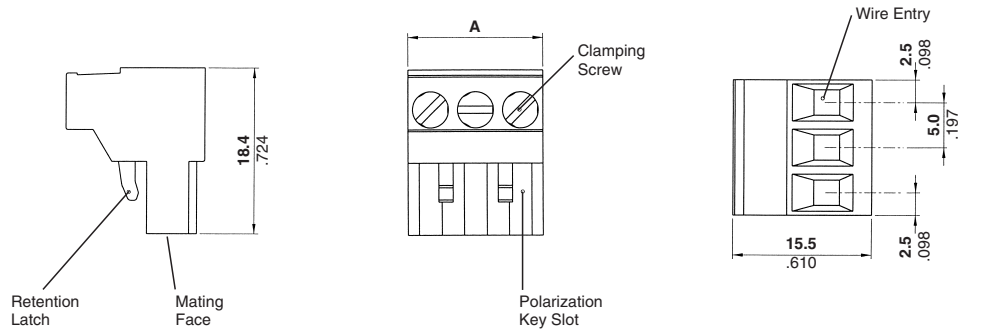
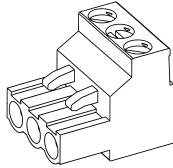

Suggested Screw Torque—
7.0 in.-lb.

No. of Positions	Dim. A	Part Numbers			
		Gray	Green	Blue	Black
2	10.0 [0.394]	1546208-2	796640-2	796696-2	796641-2
3	15.0 [0.591]	1546208-3	796640-3	796696-3	796641-3
4	20.0 [0.787]	1546208-4	796640-4	796696-4	796641-4
5	25.0 [0.984]	1546208-5	796640-5	796696-5	796641-5
6	30.0 [1.181]	1546208-6	796640-6	796696-6	796641-6
7	35.0 [1.378]	1546208-7	796640-7	796696-7	796641-7
8	40.0 [1.575]	1546208-8	796640-8	796696-8	796641-8
9	45.0 [1.772]	1546208-9	796640-9	796696-9	796641-9
10	50.0 [1.968]	1-1546208-0	1-796640-0	1-796696-0	1-796641-0
11	55.0 [2.165]	1-1546208-1	1-796640-1	1-796696-1	1-796641-1
12	60.0 [2.362]	1-1546208-2	1-796640-2	1-796696-2	1-796641-2
13	65.0 [2.559]	1-1546208-3	1-796640-3	1-796696-3	1-796641-3

No. of Positions	Dim. A	Part Numbers			
		Gray	Green	Blue	Black
14	70.0 [2.756]	1-1546208-4	1-796640-4	1-796696-4	1-796641-4
15	75.0 [2.953]	1-1546208-5	1-796640-5	1-796696-5	1-796641-5
16	80.0 [3.150]	1-1546208-6	1-796640-6	1-796696-6	1-796641-6
17	85.0 [3.346]	1-1546208-7	1-796640-7	1-796696-7	1-796641-7
18	90.0 [3.543]	1-1546208-8	1-796640-8	1-796696-8	1-796641-8
19	95.0 [3.740]	1-1546208-9	1-796640-9	1-796696-9	1-796641-9
20	100.0 [3.937]	2-1546208-0	2-796640-0	2-796696-0	2-796641-0
21	105.0 [4.134]	2-1546208-1	2-796640-1	2-796696-1	2-796641-1
22	110.0 [4.331]	2-1546208-2	2-796640-2	2-796696-2	2-796641-2
23	115.0 [4.528]	2-1546208-3	2-796640-3	2-796696-3	2-796641-3
24	120.0 [4.724]	2-1546208-4	2-796640-4	2-796696-4	2-796641-4
25	125.0 [4.921]	2-1546208-5	2-796640-5	2-796696-5	2-796641-5

Note: BUCHANAN Terminal Block Series B52C4UxxT has been replaced with 796696-xx (blue) and 796641-xx (black). RDI Terminal Block Series 5ESDV-xx has been replaced with 796640-xx (green) or 796641-xx (black).

Plug, Right-Angle, 5.08 mm Centerline Colors – See chart.

UL Rating – 300 V, 15 A 12-30 AWG

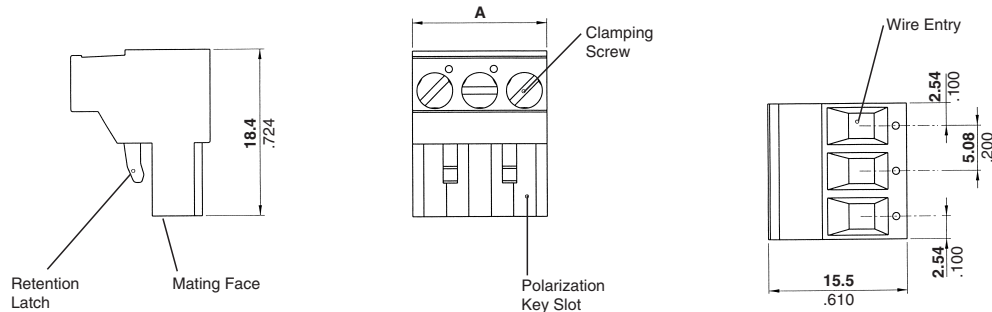
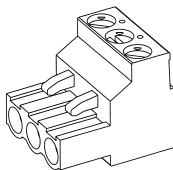

Suggested Screw Torque—
7.0 in.-lb.

No. of Positions	Dim. A	Part Numbers		
		Gray	Green	Black
2	10.16 [0.40]	1546108-2	796634-2	796635-2
3	15.24 [0.60]	1546108-3	796634-3	796635-3
4	20.32 [0.80]	1546108-4	796634-4	796635-4
5	25.40 [1.00]	1546108-5	796634-5	796635-5
6	30.48 [1.20]	1546108-6	796634-6	796635-6
7	35.56 [1.40]	1546108-7	796634-7	796635-7
8	40.64 [1.60]	1546108-8	796634-8	796635-8
9	45.72 [1.80]	1546108-9	796634-9	796635-9
10	50.80 [2.00]	1-1546108-0	1-796634-0	1-796635-0
11	55.88 [2.20]	1-1546108-1	1-796634-1	1-796635-1
12	60.96 [2.40]	1-1546108-2	1-796634-2	1-796635-2
13	66.04 [2.60]	1-1546108-3	1-796634-3	1-796635-3

No. of Positions	Dim. A	Part Numbers		
		Gray	Green	Black
14	71.12 [2.80]	1-1546108-4	1-796634-4	1-796635-4
15	76.20 [3.00]	1-1546108-5	1-796634-5	1-796635-5
16	81.28 [3.20]	1-1546108-6	1-796634-6	1-796635-6
17	86.36 [3.40]	1-1546108-7	1-796634-7	1-796635-7
18	91.44 [3.60]	1-1546108-8	1-796634-8	1-796635-8
19	96.52 [3.80]	1-1546108-9	1-796634-9	1-796635-9
20	101.60 [4.00]	2-1546108-0	2-796634-0	2-796635-0
21	106.68 [4.20]	2-1546108-1	2-796634-1	2-796635-1
22	111.76 [4.40]	2-1546108-2	2-796634-2	2-796635-2
23	116.84 [4.60]	2-1546108-3	2-796634-3	2-796635-3
24	121.92 [4.80]	2-1546108-4	2-796634-4	2-796635-4
25	127.00 [5.00]	2-1546108-5	2-796634-5	2-796635-5

Note: RDI Terminal Block Series 2ESDV-xx has been replaced with 796634-xx (green) and 796635-xx (black).

Note: All part numbers are RoHS Compliant.

Two-Piece Terminal Block Connectors (Continued)

**Plug, Right-Angle,
7.5 mm Centerline
Color – Green**

**UL Rating – 300 V, 15 A
12-30 AWG**

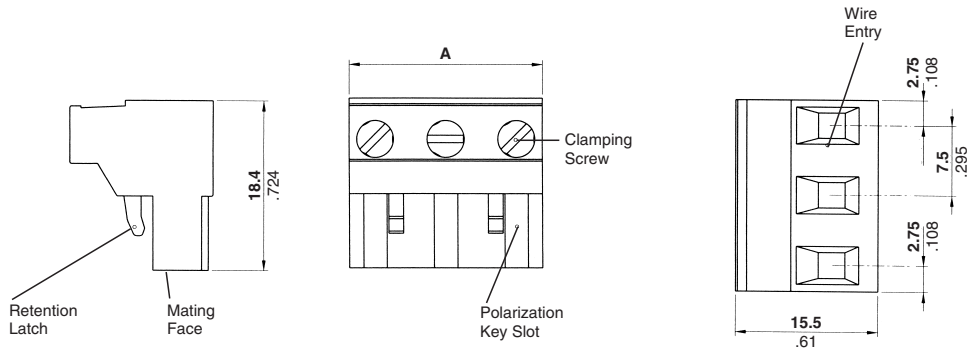
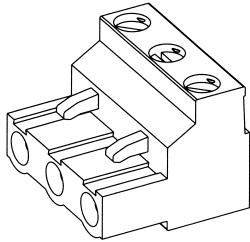

Suggested Screw Torque—
7.0 in.-lb.

No. of Positions	Dim. A	Part Numbers
2	13.0 [0.512]	282959-2
3	20.5 [0.807]	282959-3
4	28.0 [1.102]	282959-4
5	35.5 [1.398]	282959-5
6	43.0 [1.693]	282959-6
7	50.5 [1.988]	282959-7

No. of Positions	Dim. A	Part Numbers
8	58.0 [2.283]	282959-8
9	65.5 [2.579]	282959-9
10	73.0 [2.874]	1-282959-0
11	80.5 [3.169]	1-282959-1
12	88.0 [3.465]	1-282959-2

**Plug, Right-Angle,
7.62 mm Centerline
Color – Green**

**UL Rating – 300 V, 15 A
12-30 AWG**

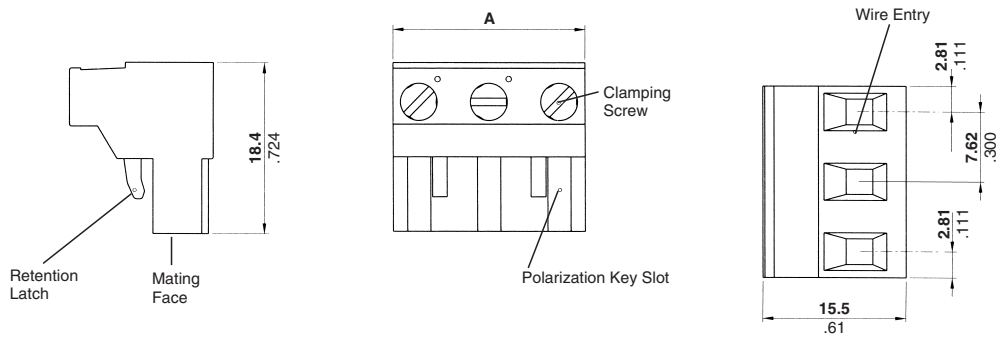
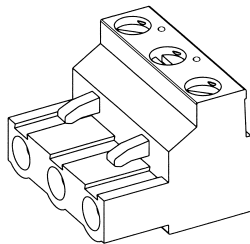

Suggested Screw Torque—
7.0 in.-lb.

No. of Positions	Dim. A	Part Numbers
2	13.24 [0.521]	796981-2
3	20.86 [0.821]	796981-3
4	28.48 [1.121]	796981-4
5	36.10 [1.421]	796981-5
6	43.72 [1.721]	796981-6
7	51.34 [2.021]	796981-7

No. of Positions	Dim. A	Part Numbers
8	58.96 [2.321]	796981-8
9	66.58 [2.621]	796981-9
10	74.20 [2.921]	1-796981-0
11	81.82 [3.221]	1-796981-1
12	89.44 [3.521]	1-796981-2

Note: All part numbers are RoHS Compliant.

Two-Piece Terminal Block Connectors (Continued)

**Plug, Right-Angle,
10.0 mm Centerline
Color – Green**

**UL Rating – 600 V, 15 A
12-30 AWG**

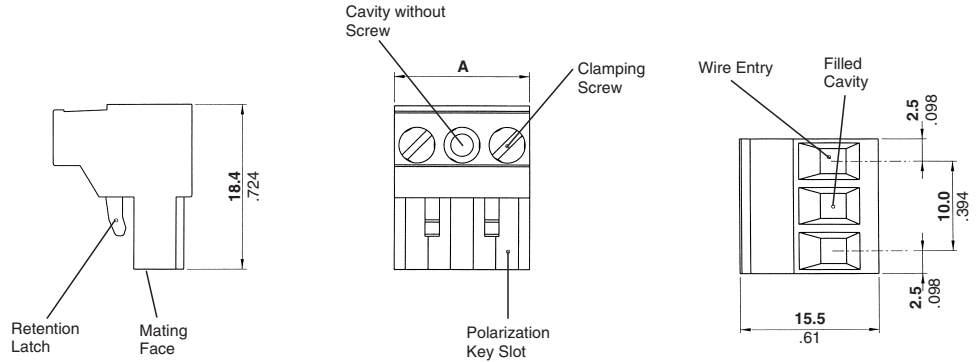
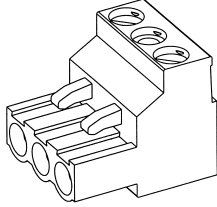

Suggested Screw Torque—
7.0 in.-lb.

No. of Positions	Dim. A	Part Numbers
2	15.0 [0.591]	282808-2
3	25.0 [0.984]	282808-3
4	35.0 [1.378]	282808-4
5	45.0 [1.772]	282808-5
6	55.0 [2.165]	282808-6
7	65.0 [2.559]	282808-7

No. of Positions	Dim. A	Part Numbers
8	75.0 [2.953]	282808-8
9	85.0 [3.346]	282808-9
10	95.0 [3.740]	1-282808-0
11	105.0 [4.134]	1-282808-1
12	115.0 [4.528]	1-282808-2
13	125.0 [4.921]	1-282808-3

**Plug, Right-Angle,
10.16 mm Centerline
Color – Green**

**UL Rating – 600 V, 15 A
12-30 AWG**

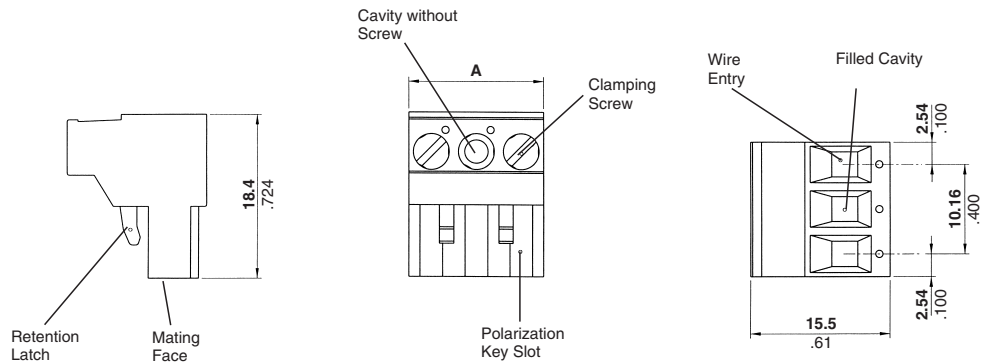
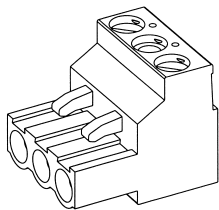

Suggested Screw Torque—
7.0 in.-lb.

No. of Positions	Dim. A	Part Numbers
2	15.24 [0.60]	282809-2
3	25.40 [1.00]	282809-3
4	35.56 [1.40]	282809-4
5	45.72 [1.80]	282809-5
6	55.88 [2.20]	282809-6
7	66.04 [2.60]	282809-7

No. of Positions	Dim. A	Part Numbers
8	76.20 [3.00]	282809-8
9	86.36 [3.40]	282809-9
10	96.52 [3.80]	1-282809-0
11	106.68 [4.20]	1-282809-1
12	116.84 [4.60]	1-282809-2
13	127.00 [5.00]	1-282809-3

Note: All part numbers are RoHS Compliant.

Two-Piece Terminal Block Connectors (Continued)

**Plug, Right-Angle w/Interlock,
3.81 mm Centerline
Color – Green**

**UL Rating – 150 V, 12 A
14-30 AWG**

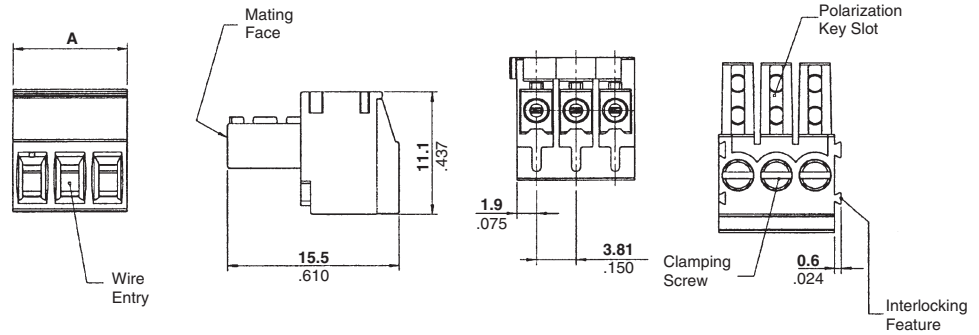
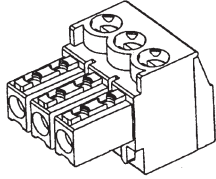

Suggested Screw Torque—
2.2 in.-lb.

No. of Positions	Dim. A	Part Numbers
2	7.62 [0.30]	284509-2
3	11.43 [0.45]	284509-3
4	15.24 [0.60]	284509-4
5	19.05 [0.75]	284509-5
6	22.86 [0.90]	284509-6
7	26.67 [1.05]	284509-7
8	30.48 [1.20]	284509-8
9	34.29 [1.35]	284509-9
10	38.10 [1.50]	1-284509-0
11	41.91 [1.65]	1-284509-1
12	45.72 [1.80]	1-284509-2
13	49.53 [1.95]	1-284509-3
14	53.34 [2.10]	1-284509-4
15	57.15 [2.25]	1-284509-5
16	60.96 [2.40]	1-284509-6
17	64.77 [2.55]	1-284509-7
18	68.58 [2.70]	1-284509-8
19	72.39 [2.85]	1-284509-9
20	86.20 [3.00]	2-284509-0
21	80.01 [3.15]	2-284509-1
22	83.82 [3.30]	2-284509-2
23	87.63 [3.45]	2-284509-3
24	91.44 [3.60]	2-284509-4
25	95.25 [3.75]	2-284509-5

Note: All part numbers are RoHS Compliant.

Two-Piece Terminal Block Connectors (Continued)

Stacking Plug, Right-Angle with Interlock, 5.0 mm Centerline Color – Green

UL Rating – 300 V, 15 A 12-30 AWG

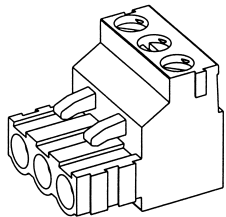

Suggested Screw Torque—
7.0 in.-lb.

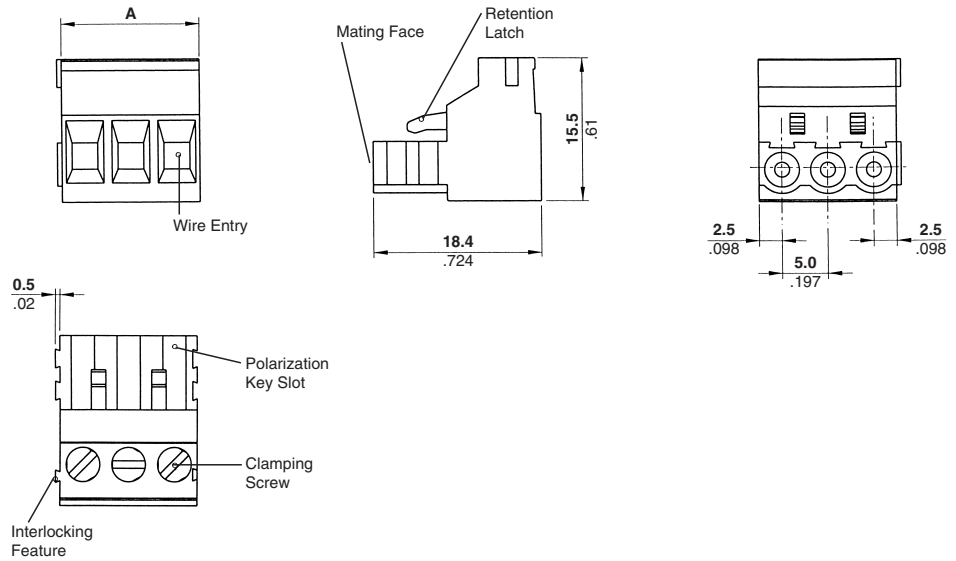

No. of Positions	Dim. A	Part Numbers
2	10.0 [.394]	282805-2
3	15.0 [.591]	282805-3
4	20.0 [.787]	282805-4

Stacking Plug, Right-Angle with Interlock, 5.08 mm Centerline Color – Green

UL Rating – 300 V, 15 A 12-30 AWG

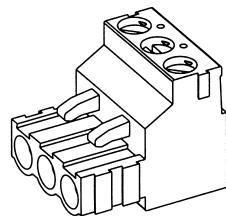

Suggested Screw Torque—
7.0 in.-lb.

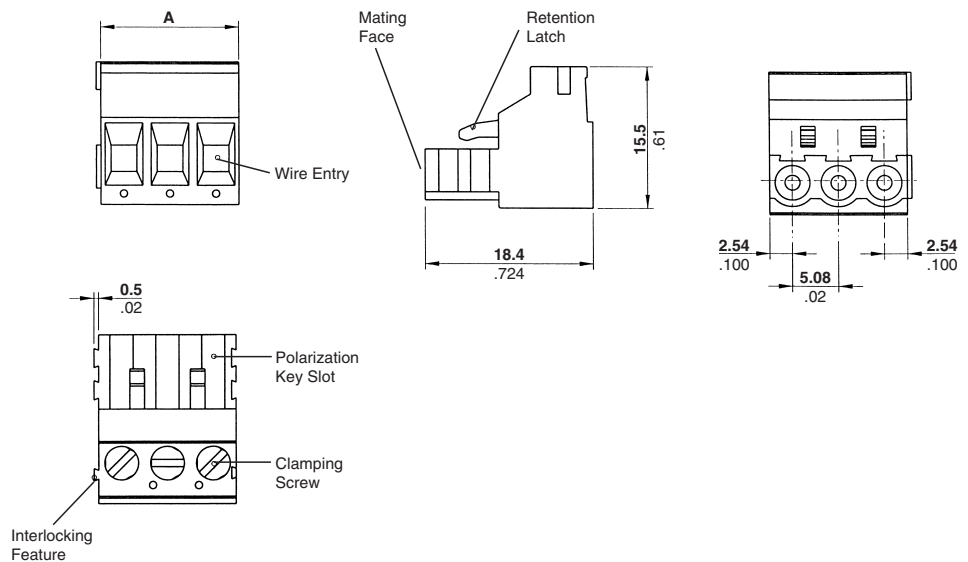

No. of Positions	Dim. A	Part Numbers
2	10.16 [.400]	282807-2
3	15.24 [.600]	282807-3
4	20.32 [.800]	282807-4



Note: All part numbers are RoHS Compliant.

Straight Plugs

**Plug, Straight,
5.0 mm Centerline
Color – See chart.**

**UL Rating – 300 V, 15 A
12-30 AWG**

**Suggested Screw Torque—
7.0 in.-lbs.**

Left-Hand Version

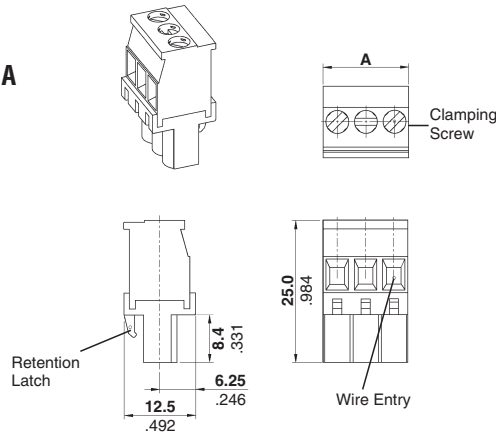

Right-Hand Version

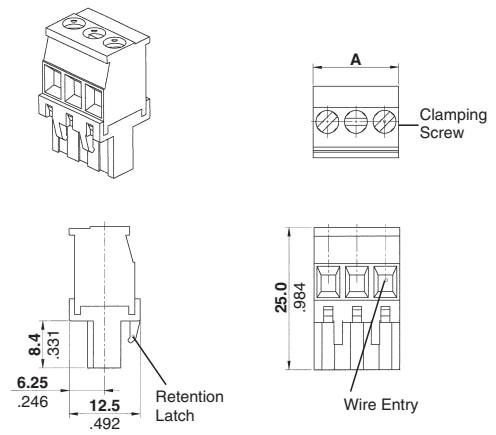

No. of Positions	Dim. A	Part Numbers					
		Left-Hand			Right-Hand		
		Green	Black	Gray	Green	Black	Gray
2	10.0 [.394]	284040-2	1546118-2	1546223-2	284046-2	1546625-2	1546857-2
3	15.0 [.591]	284040-3	1546118-3	1546223-3	284046-3	1546625-3	1546857-3
4	20.0 [.787]	284040-4	1546118-4	1546223-4	284046-4	1546625-4	1546857-4
5	25.0 [.984]	284040-5	1546118-5	1546223-5	284046-5	1546625-5	1546857-5
6	30.0 [1.181]	284040-6	1546118-6	1546223-6	284046-6	1546625-6	1546857-6
7	35.0 [1.378]	284040-7	1546118-7	1546223-7	284046-7	1546625-7	1546857-7
8	40.0 [1.575]	284040-8	1546118-8	1546223-8	284046-8	1546625-8	1546857-8
9	45.0 [1.772]	284040-9	1546118-9	1546223-9	284046-9	1546625-9	1546857-9
10	50.0 [1.968]	1-284040-0	1-1546118-0	1-1546223-0	1-284046-0	1-1546625-0	1-1546857-0
11	55.0 [2.165]	1-284040-1	1-1546118-1	1-1546223-1	1-284046-1	1-1546625-1	1-1546857-1
12	60.0 [2.362]	1-284040-2	1-1546118-2	1-1546223-2	1-284046-2	1-1546625-2	1-1546857-2
13	65.0 [2.559]	1-284040-3	1-1546118-3	1-1546223-3	1-284046-3	1-1546625-3	1-1546857-3
14	70.0 [2.756]	1-284040-4	1-1546118-4	1-1546223-4	1-284046-4	1-1546625-4	1-1546857-4
15	75.0 [2.953]	1-284040-5	1-1546118-5	1-1546223-5	1-284046-5	1-1546625-5	1-1546857-5
16	80.0 [3.150]	1-284040-6	1-1546118-6	1-1546223-6	1-284046-6	1-1546625-6	1-1546857-6
17	85.0 [3.346]	1-284040-7	1-1546118-7	1-1546223-7	1-284046-7	1-1546625-7	1-1546857-7
18	90.0 [3.543]	1-284040-8	1-1546118-8	1-1546223-8	1-284046-8	1-1546625-8	1-1546857-8
19	95.0 [3.740]	1-284040-9	1-1546118-9	1-1546223-9	1-284046-9	1-1546625-9	1-1546857-9
20	100.0 [3.937]	2-284040-0	2-1546118-0	2-1546223-0	2-284046-0	2-1546625-0	2-1546857-0
21	105.0 [4.134]	2-284040-1	2-1546118-1	2-1546223-1	2-284046-1	2-1546625-1	2-1546857-1
22	110.0 [4.331]	2-284040-2	2-1546118-2	2-1546223-2	2-284046-2	2-1546625-2	2-1546857-2
23	115.0 [4.528]	2-284040-3	2-1546118-3	2-1546223-3	2-284046-3	2-1546625-3	2-1546857-3
24	120.0 [4.724]	2-284040-4	2-1546118-4	2-1546223-4	2-284046-4	2-1546625-4	2-1546857-4
25	125.0 [4.921]	2-284040-5	2-1546118-5	2-1546223-5	2-284046-5	2-1546625-5	2-1546857-5

Note: All part numbers are RoHS Compliant.

Straight Plugs (Continued)

**Plug, Straight,
5.08 mm Centerline
Color – See chart.
UL Rating – 300 V, 15 A
12-30 AWG**

**Suggested Screw Torque—
7.0 in.-lbs.**

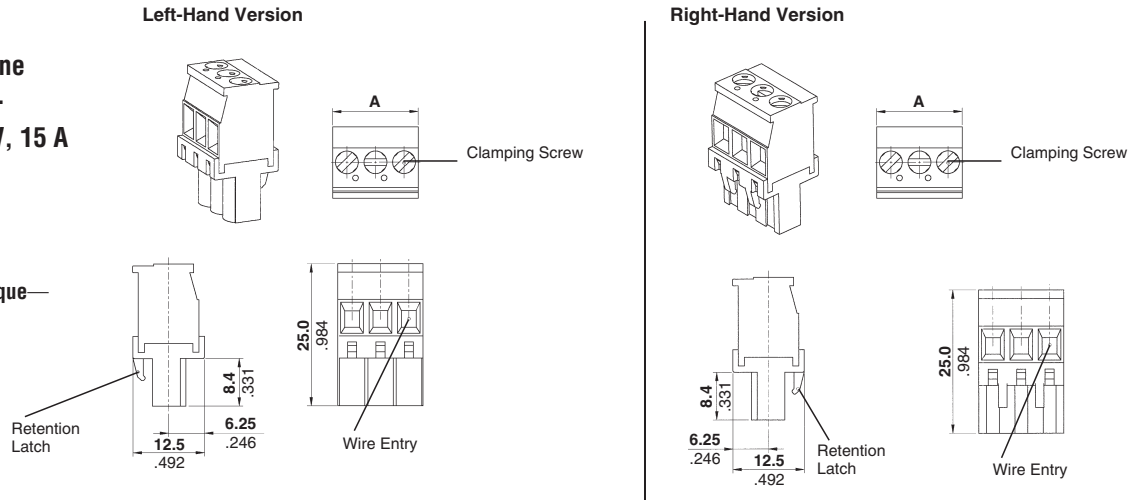

No. of Positions	Dim. A	Part Numbers					
		Left-Hand			Right-Hand		
		Green	Black	Gray	Green	Black	Gray
2	10.16 [.400]	284041-2	1546105-2	1546224-2	284047-2	1546231-2	1546122-2
3	15.24 [.600]	284041-3	1546105-3	1546224-3	284047-3	1546231-3	1546122-3
4	20.32 [.800]	284041-4	1546105-4	1546224-4	284047-4	1546231-4	1546122-4
5	25.40 [1.000]	284041-5	1546105-5	1546224-5	284047-5	1546231-5	1546122-5
6	30.48 [1.200]	284041-6	1546105-6	1546224-6	284047-6	1546231-6	1546122-6
7	35.56 [1.400]	284041-7	1546105-7	1546224-7	284047-7	1546231-7	1546122-7
8	40.64 [1.600]	284041-8	1546105-8	1546224-8	284047-8	1546231-8	1546122-8
9	45.72 [1.800]	284041-9	1546105-9	1546224-9	284047-9	1546231-9	1546122-9
10	50.80 [2.000]	1-284041-0	1-1546105-0	1-1546224-0	1-284047-0	1-1546231-0	1-1546122-0
11	55.88 [2.200]	1-284041-1	1-1546105-1	1-1546224-1	1-284047-1	1-1546231-1	1-1546122-1
12	60.96 [2.400]	1-284041-2	1-1546105-2	1-1546224-2	1-284047-2	1-1546231-2	1-1546122-2
13	66.04 [2.600]	1-284041-3	1-1546105-3	1-1546224-3	1-284047-3	1-1546231-3	1-1546122-3
14	71.12 [2.800]	1-284041-4	1-1546105-4	1-1546224-4	1-284047-4	1-1546231-4	1-1546122-4
15	76.20 [3.000]	1-284041-5	1-1546105-5	1-1546224-5	1-284047-5	1-1546231-5	1-1546122-5
16	81.28 [3.200]	1-284041-6	1-1546105-6	1-1546224-6	1-284047-6	1-1546231-6	1-1546122-6
17	86.36 [3.400]	1-284041-7	1-1546105-7	1-1546224-7	1-284047-7	1-1546231-7	1-1546122-7
18	91.44 [3.600]	1-284041-8	1-1546105-8	1-1546224-8	1-284047-8	1-1546231-8	1-1546122-8
19	96.52 [3.800]	1-284041-9	1-1546105-9	1-1546224-9	1-284047-9	1-1546231-9	1-1546122-9
20	101.60 [4.000]	2-284041-0	2-1546105-0	2-1546224-0	2-284047-0	2-1546231-0	2-1546122-0
21	106.68 [4.200]	2-284041-1	2-1546105-1	2-1546224-1	2-284047-1	2-1546231-1	2-1546122-1
22	111.76 [4.400]	2-284041-2	2-1546105-2	2-1546224-2	2-284047-2	2-1546231-2	2-1546122-2
23	116.84 [4.600]	2-284041-3	2-1546105-3	2-1546224-3	2-284047-3	2-1546231-3	2-1546122-3
24	121.92 [4.800]	2-284041-4	2-1546105-4	2-1546224-4	2-284047-4	2-1546231-4	2-1546122-4
25	127.00 [5.000]	2-284041-5	2-1546105-5	2-1546224-5	2-284047-5	2-1546231-5	2-1546122-5



Note: All part numbers are RoHS Compliant.

Straight Plugs (Continued)

**Plug, Straight,
7.5 mm and 10.0 mm Centerline
Color – Green**

**UL Rating – 300 V, 15 A
12-30 AWG**

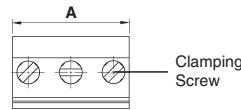
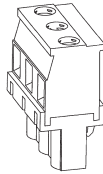

Left-Hand Version

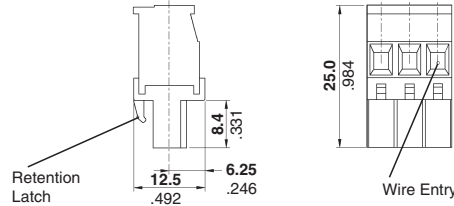

Suggested Screw Torque—7.0 in.-lbs.

No. of Positions	Dim. A	7.5 mm Centerline Part Numbers	
		Wire Entry	Left-Hand
2	13.0 [.512]	284042-2	
3	20.5 [.807]	284042-3	
4	28.0 [1.102]	284042-4	
5	35.5 [1.398]	284042-5	
6	43.0 [1.693]	284042-6	
7	50.5 [1.988]	284042-7	
8	58.0 [2.283]	284042-8	
9	65.5 [2.579]	284042-9	
10	73.0 [2.874]	1-284042-0	
11	80.5 [3.169]	1-284042-1	
12	88.0 [3.465]	1-284042-2	

No. of Positions	Dim. A	10.0 mm Centerline Part Numbers	
		Wire Entry	Left-Hand
2	15.0 [0.591]	284044-2	
3	25.0 [0.984]	284044-3	
4	35.0 [1.378]	284044-4	
5	45.0 [1.772]	284044-5	
6	55.0 [2.165]	284044-6	
7	65.0 [2.559]	284044-7	
8	75.0 [2.953]	284044-8	
9	85.0 [3.346]	284044-9	
10	95.0 [3.740]	1-284044-0	
11	105.0 [4.134]	1-284044-1	
12	115.0 [4.528]	1-284044-2	
13	125.0 [4.921]	1-284044-3	

**Plug, Straight,
7.62 mm and 10.16 mm Centerline**

**UL Rating – 300 V, 15 A
12-30 AWG**

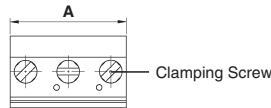

Left-Hand Version

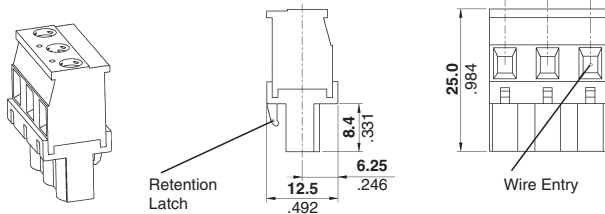

Right-Hand Version

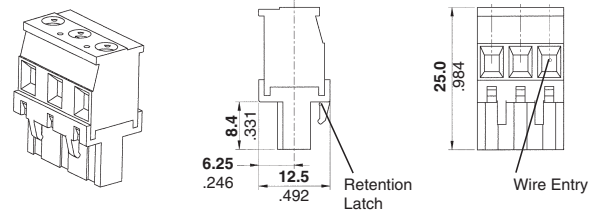

Suggested Screw Torque—7.0 in.-lbs.

No. of Positions	Dim. A	7.62 mm Centerline Part Numbers		
		Wire Entry		
		Left-Hand	Right-Hand	
		Green	Black	Green
2	13.24 [.521]	284043-2	1546935-2	284049-2
3	20.86 [.821]	284043-3	1546935-3	284049-3
4	28.48 [1.121]	284043-4	1546935-4	284049-4
5	36.10 [1.421]	284043-5	1546935-5	284049-5
6	43.72 [1.721]	284043-6	1546935-6	284049-6
7	51.34 [2.021]	284043-7	1546935-7	284049-7
8	58.96 [2.321]	284043-8	1546935-8	284049-8
9	66.58 [2.621]	284043-9	1546935-9	284049-9
10	74.20 [2.921]	1-284043-0	1-1546935-0	1-284049-0
11	81.82 [3.221]	1-284043-1	1-1546935-1	1-284049-1
12	89.44 [3.521]	1-284043-2	—	1-284049-2

No. of Positions	Dim. A	10.16 mm Centerline Part Numbers		
		Wire Entry		
		Left-Hand	Right-Hand	
		Green	Green	Black
2	15.24 [0.600]	284045-2	284051-2	1776538-2
3	25.40 [1.000]	284045-3	284051-3	1776538-3
4	35.56 [1.400]	284045-4	284051-4	1776538-4
5	45.72 [1.800]	284045-5	284051-5	1776538-5
6	55.88 [2.200]	284045-6	284051-6	1776538-6
7	66.04 [2.600]	284045-7	284051-7	1776538-7
8	76.20 [3.000]	284045-8	284051-8	1776538-8
9	86.36 [3.400]	284045-9	284051-9	1776538-9
10	96.52 [3.800]	1-284045-0	1-284051-0	1-1776538-0
11	106.68 [4.200]	1-284045-1	1-284051-1	1-1776538-1
12	116.84 [4.600]	1-284045-2	1-284051-2	1-1776538-2
13	127.00 [5.000]	1-284045-3	1-284051-3	—

Note: All part numbers are RoHS Compliant.

Unshrouded Straight Pin Headers

Unshrouded Straight Pin Headers, 5.0 mm Centerline Color – Black UL Rating – 300 V, 12 A

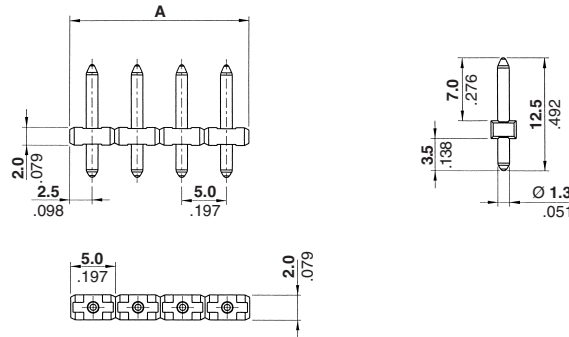
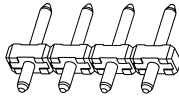

Recommended PC Board Layout

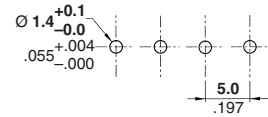

No. of Positions	Dim. A	Part Numbers*
2	10.0 [.394]	1546931-2
3	15.0 [.591]	1546931-3
4	20.0 [.787]	1546931-4
5	25.0 [.984]	1546931-5
6	30.0 [1.181]	1546931-6
7	35.0 [1.378]	1546931-7
8	40.0 [1.575]	1546931-8
9	45.0 [1.772]	1546931-9
10	50.0 [1.968]	1-1546931-0
11	55.0 [2.165]	1-1546931-1
12	60.0 [2.362]	1-1546931-2
13	65.0 [2.559]	1-1546931-3

No. of Positions	Dim. A	Part Numbers*
14	70.0 [2.756]	1-1546931-4
15	75.0 [2.953]	1-1546931-5
16	80.0 [3.150]	1-1546931-6
17	85.0 [3.346]	1-1546931-7
18	90.0 [3.543]	1-1546931-8
19	95.0 [3.740]	1-1546931-9
20	100.0 [3.937]	2-1546931-0
21	105.0 [4.134]	2-1546931-1
22	110.0 [4.331]	2-1546931-2
23	115.0 [4.528]	2-1546931-3
24	120.0 [4.724]	2-1546931-4
25	125.0 [4.921]	2-1546931-5

Note: Mate with Special Plug Connectors on pages 86 and 87.
*Wave solder process capable to 265°C [509°F] for 10 seconds.

Unshrouded Straight Pin Headers, 10.0 mm Centerline Color – Black UL Rating – 300 V, 12 A

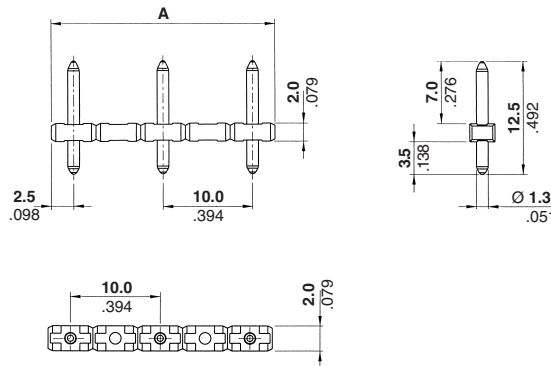
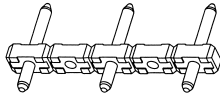

Recommended PC Board Layout

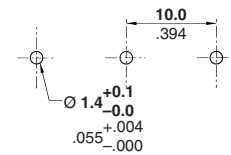

No. of Positions	Dim. A	Part Numbers*
2	15.0 [.591]	1546932-2
3	25.0 [.984]	1546932-3
4	35.0 [1.378]	1546932-4
5	45.0 [1.772]	1546932-5
6	55.0 [2.165]	1546932-6

Note: Mate with Special Plug Connectors on page 88.
*Wave solder process capable to 265°C [509°F] for 10 seconds.



Note: All part numbers are RoHS Compliant.

Special Plug Connectors

Special 90°/180° Plug Connectors, 5.0 mm Centerline Color – See chart.

UL Rating – 300 V, 12 A 14-30 AWG

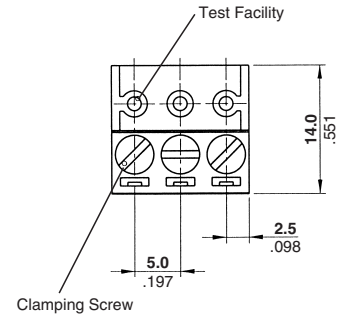
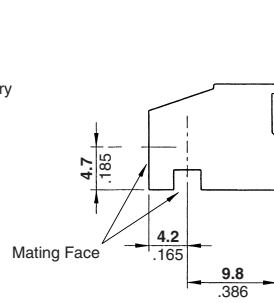
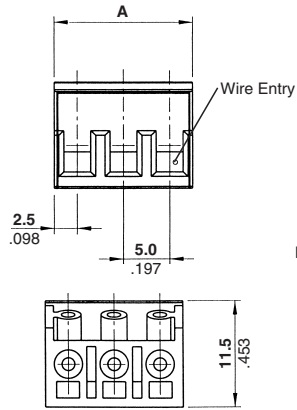
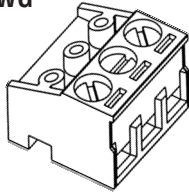

Suggested Screw Torque—6.0 in.-lbs.

No. of Positions	Dim. A	Part Numbers	
		Green	Black
2	10.0 [.394]	282830-2	1546018-2
3	15.0 [.591]	282830-3	1546018-3
4	20.0 [.787]	282830-4	1546018-4
5	25.0 [.984]	282830-5	1546018-5
6	30.0 [1.181]	282830-6	1546018-6
7	35.0 [1.378]	282830-7	1546018-7
8	40.0 [1.575]	282830-8	1546018-8
9	45.0 [1.772]	282830-9	1546018-9
10	50.0 [1.968]	1-282830-0	1-1546018-0
11	55.0 [2.165]	1-282830-1	1-1546018-1
12	60.0 [2.362]	1-282830-2	1-1546018-2
13	65.0 [2.559]	1-282830-4	1-1546018-3

Note: Mate only with 1546931 (black) pin headers.

No. of Positions	Dim. A	Part Numbers	
		Green	Black
14	70.0 [.591]	1-282830-5	1-1546018-4
15	75.0 [.787]	1-282830-6	1-1546018-5
16	80.0 [.984]	1-282830-7	1-1546018-6
17	85.0 [1.181]	1-282830-8	1-1546018-7
18	90.0 [1.378]	1-282830-9	1-1546018-8
19	95.0 [1.575]	2-282830-0	1-1546018-9
20	100.0 [1.772]	2-282830-1	2-1546018-0
21	105.0 [1.968]	2-282830-2	2-1546018-1
22	110.0 [2.165]	2-282830-3	2-1546018-2
23	115.0 [2.362]	2-282830-4	2-1546018-3
24	120.0 [2.362]	2-282830-5	2-1546018-4
25	125.0 [2.362]	2-282830-6	2-1546018-5

Special 90°/270° Plug Connectors, 5.0 mm Centerline Color – Gray

UL Rating – 300 V, 12 A 14-30 AWG

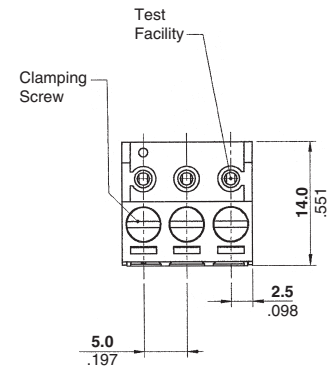
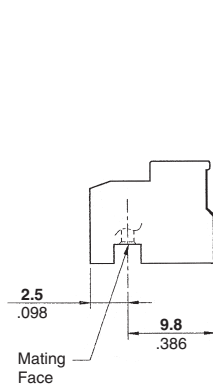
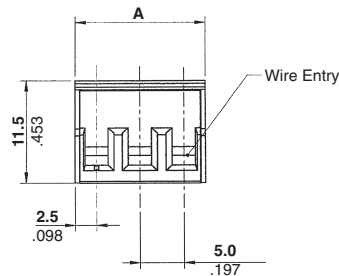
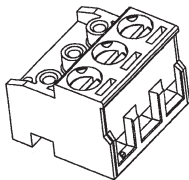

Suggested Screw Torque—6.0 in.-lbs.

No. of Positions	Dim. A	Part Numbers
2	10.0 [.394]	1546226-2
3	15.0 [.591]	1546226-3
4	20.0 [.787]	1546226-4
5	25.0 [.984]	1546226-5
6	30.0 [1.181]	1546226-6
7	35.0 [1.378]	1546226-7
8	40.0 [1.575]	1546226-8
9	45.0 [1.772]	1546226-9
10	50.0 [1.968]	1-1546226-0
11	55.0 [2.165]	1-1546226-1
12	60.0 [2.362]	1-1546226-2
13	65.0 [2.559]	1-1546226-3

Note: Mate only with 1546931 (black) pin headers.

No. of Positions	Dim. A	Part Numbers
14	70.0 [.591]	1-1546226-4
15	75.0 [.787]	1-1546226-5
16	80.0 [.984]	1-1546226-6
17	85.0 [1.181]	1-1546226-7
18	90.0 [1.378]	1-1546226-8
19	95.0 [1.575]	1-1546226-9
20	100.0 [1.772]	2-1546226-0
21	105.0 [1.968]	2-1546226-1
22	110.0 [2.165]	2-1546226-2
23	115.0 [2.362]	2-1546226-3
24	120.0 [2.362]	2-1546226-4
25	125.0 [2.362]	2-1546226-5

Note: All part numbers are RoHS Compliant.

Special Plug Connectors with Latch

Special 90°/270° Plug Connectors with Latch, 5.0 mm Centerline Color – Green

UL Rating – 300 V, 12 A 14-30 AWG

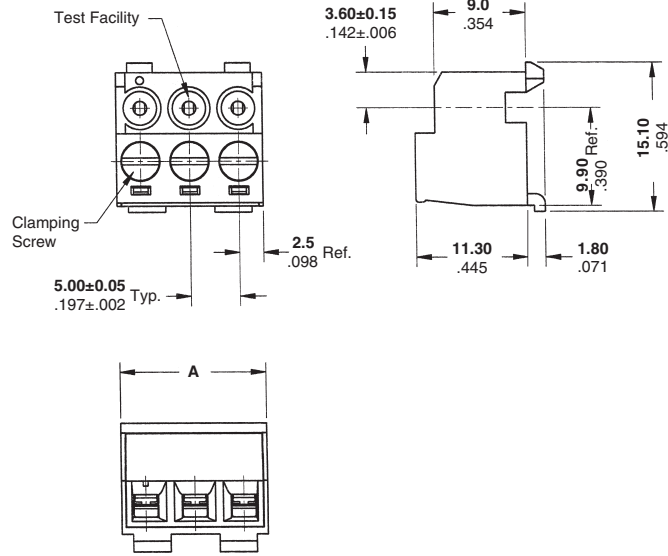
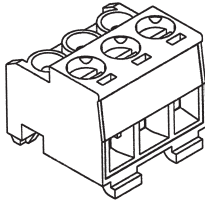

Suggested Screw Torque—6.0 in.-lbs.

No. of Positions	Dimension A	Part Numbers
2	10.0 [0.394]	1546173-2
3	15.0 [0.591]	1546173-3
4	20.0 [0.787]	1546173-4
5	25.0 [0.984]	1546173-5
6	30.0 [1.181]	1546173-6
7	35.0 [1.378]	1546173-7
8	40.0 [1.575]	1546173-8
9	45.0 [1.772]	1546173-9
10	50.0 [1.969]	1-1546173-0
11	55.0 [2.165]	1-1546173-1
12	60.0 [2.362]	1-1546173-2

Note: Mate only with 1546931 (black) pin headers.



Note: All part numbers are RoHS Compliant.

Special Plug Connectors

Special 90°/180° Plug Connectors, 10.0 mm Centerline Color – Green
UL Rating – 600 V, 12 A
14-30 AWG

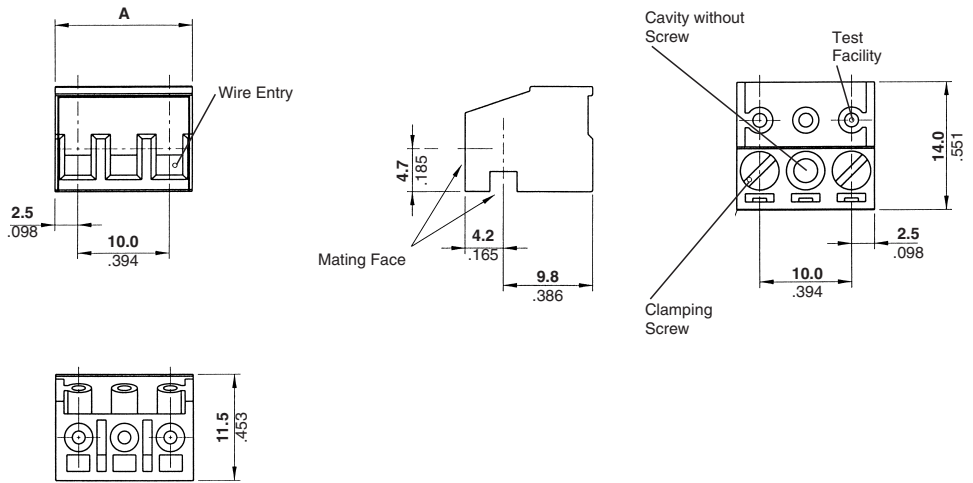
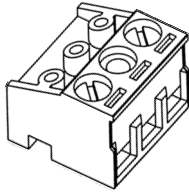

Suggested Screw Torque—6.0 in.-lbs.

No. of Positions	Dim. A	Part Numbers
2	15.0 [.591]	282831-2
3	25.0 [.984]	282831-3
4	35.0 [1.378]	282831-4
5	45.0 [1.772]	282831-5
6	55.0 [2.165]	282831-6

Note: Mate only with 1546932 pin headers.

Note: All part numbers are RoHS Compliant.

Flush-Mount Connectors

5 mm Pitch



B51C4U (universal mounting)

A DIM
5 mm: A = N x 5
N = # of Poles

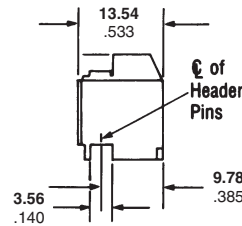
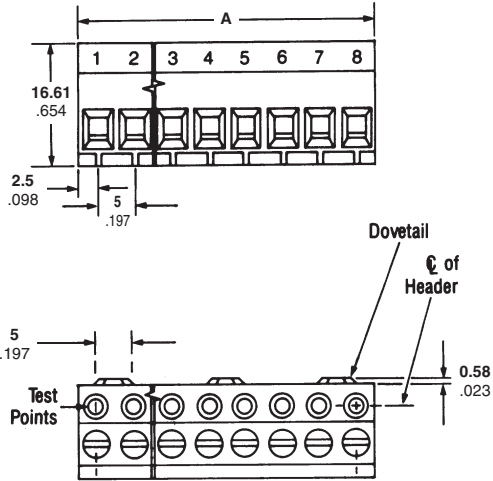

5 mm Flush-Mount Plug-In Connectors with Cage Clamp Series B51C4 (Mate with Series B71N4 Pin Headers)

Material & Finish

Housing Material—Polyamide, Type 6/6

Flammability—UL94V-0

Color—Black

Wire Entry Contact and Spring—Phosphor bronze, tin plated

Wire Cage—Hardened steel, zinc plated, yellow chromate treated

Screw—M2.5 x 6.2mm, steel, zinc plated, clear chromate treated

Mechanical Properties

Pitch (terminal spacing)—5mm

Wire Strip Length—6.4mm

Recommended Tightening Torque—0.5Nm [4.4 in-lbs]

Electrical Properties

Maximum Current—15A

Operating Voltage—300V (5mm)

Wire Range—12-30 AWG

Dielectric Withstand—2200V (5mm)

Environmental Properties

Operating Temperature Range—-60°C to +105°C [-76°F to +221°F]

No. of Positions	5mm Universal	
	Part Number	Catalog Number
2	1437426-1	B51C4U02T
3	1437426-3	B51C4U03T
4	1437426-9	B51C4U04T
5	1-1437426-3	B51C4U05T
6	1-1437426-6	B51C4U06T
7	2-1437426-0	B51C4U07T
8	2-1437426-5	B51C4U08T
9	2-1437426-8	B51C4U09T
10	3-1437426-2	B51C4U10T
11	3-1437426-6	B51C4U11T
12	3-1437426-9	B51C4U12T
13	4-1437426-6	B51C4U13T
14	4-1437426-9	B51C4U14T
15	5-1437426-1	B51C4U15T
16	5-1437426-3	B51C4U16T
17	—	B51C4U17T
18	5-1437426-6	B51C4U18T
19	—	B51C4U19T
20	5-1437426-7	B51C4U20T
21	—	B51C4U21T
22	5-1437426-8	B51C4U22T
23	—	B51C4U23T
24	5-1437426-9	B51C4U24T



Note: All part numbers are RoHS Compliant.

Flush-Mount Pin Headers

5 mm Pitch



5 mm Flush-Mount Pin Headers Series B71N4 (Mate with Series B51C4 Connectors)

Material & Finish

Housing Material—Liquid crystal polymer

Flammability—UL94V-0

Color—Black

Solder Pin—Phosphor bronze, tin plated

Mechanical Properties

Pitch (Pin Spacing)—5mm

Recommended PCB Hole Dia.—1.7mm

Electrical Properties

Maximum Current—15A

Operating Voltage—300V (5mm)

Environmental Properties

Operating Temperature Range—
-30°C to +105°C [-22°F to 221°F] Tin contact system

(Vertical Solder Pins)

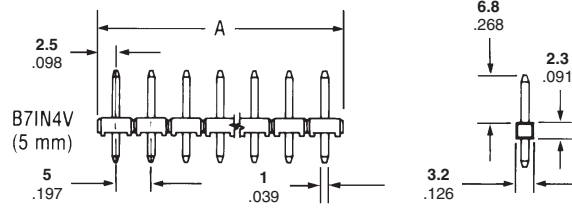

Series B51C4 Plug-in Connector

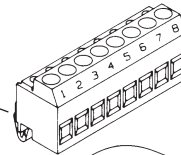

Series B71N4 Vertical Pin Header

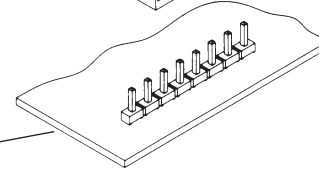

No. of Positions	Dimension A	Part Number	Catalog Number
2	10.00 [.394]	1776452-2	B71N4V02T
3	15.00 [.591]	1776452-3	B71N4V03T
4	15.00 [.591]	1776452-4	B71N4V04T
5	25.00 [.984]	1776452-5	B71N4V05T
6	30.00 [1.181]	1776452-6	B71N4V06T
7	35.00 [1.378]	1776452-7	B71N4V07T
8	40.00 [1.575]	1776452-8	B71N4V08T
9	45.00 [1.772]	1776452-9	B71N4V09T
10	50.00 [1.969]	1-1776452-0	B71N4V10T
11	55.00 [2.165]	1-1776452-1	B71N4V11T
12	60.00 [2.362]	1-1776452-2	B71N4V12T
13	65.00 [2.559]	1-1776452-3	B71N4V13T
14	70.00 [2.756]	1-1776452-4	B71N4V14T
15	75.00 [2.953]	1-1776452-5	B71N4V15T
16	80.00 [3.150]	1-1776452-6	B71N4V16T
17	85.00 [3.346]	1-1776452-7	B71N4V17T
18	90.00 [3.543]	1-1776452-8	B71N4V18T
19	—	—	B71N4V19T
20	100.00 [3.937]	2-1776452-0	B71N4V20T
21	—	—	B71N4V21T
22	110.00 [4.331]	2-1776452-2	B71N4V22T
23	—	—	B71N4V23T
24	120.00 [4.724]	2-1776452-4	B71N4V24T



Note: All part numbers are RoHS Compliant.

Flush-Mount Connectors

5.08 mm Pitch

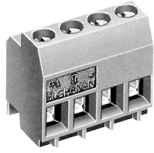

B51C8U (universal mounting)

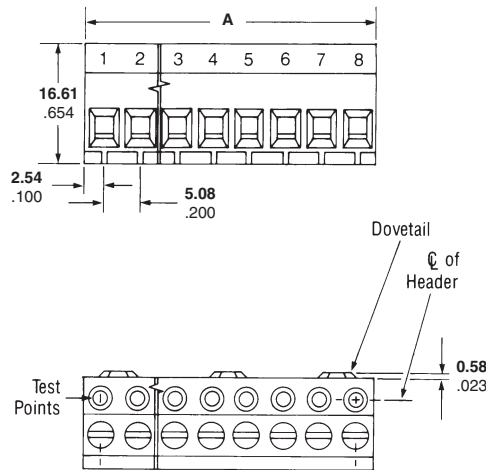

5.08 mm Flush-Mount Plug-In Connectors with Cage Clamp Series B51C8 (Mate with Series B71N8 Pin Headers)

Material & Finish

Housing Material—Polyamide, Type 6/6

Flammability—UL94V-0

Color—Blue

Wire Entry Contact and Spring—Phosphor bronze, tin plated

Wire Cage—Hardened steel, zinc plated, yellow chromate treated

Screw—M2.5 x 6.2mm, steel, zinc plated, clear chromate treated

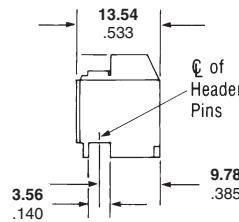

Mechanical Properties

Pitch (terminal spacing)—5.08mm

Mounting—Universal (vertical & horizontal)

Wire Strip Length—6.4mm

Recommended Tightening Torque—0.5 Nm (4.4 in-lbs)

Electrical Properties

Maximum Current—15A

Operating Voltage—300V (5.08mm)

Wire Range—12-30 AWG

Dielectric Withstand—2200V (5.08mm)

Environmental Properties

Operating Temperature Range—-60°C to +105°C [-76°F to 221°F]

No. of Positions	Dim. A	Part Number	Catalog Number
2	10.16 [.400]	7-1437426-1	B51C8U02T
3	15.24 [.600]	7-1437426-2	B51C8U03T
4	20.32 [.800]	7-1437426-4	B51C8U04T
5	25.40 [1.000]	7-1437426-5	B51C8U05T
6	30.48 [1.200]	7-1437426-7	B51C8U06T
7	35.56 [1.400]	7-1437426-8	B51C8U07T
8	40.64 [1.600]	8-1437426-0	B51C8U08T
9	45.72 [1.800]	8-1437426-1	B51C8U09T
10	50.80 [2.000]	8-1437426-3	B51C8U10T
11	55.88 [2.200]	8-1437426-6	B51C8U11T
12	60.96 [2.400]	8-1437426-7	B51C8U12T
13	66.04 [2.600]	9-1437426-0	B51C8U13T
14	71.12 [2.800]	9-1437426-1	B51C8U14T
15	76.20 [3.000]	9-1437426-2	B51C8U15T

Note: All part numbers are RoHS Compliant.

Flush-Mount Pin Headers

5.08 mm Pitch



5.08 mm Flush-Mount Pin Headers Series B71N8 (Mates with Series B51C8 Connectors)

Material & Finish

Housing Material—Liquid crystal polymer

Flammability—UL94V-0

Color—Brown

Pin—Phosphor bronze, tin plated

Mechanical Properties

Pitch (pin spacing)—5.08mm

Recommended PCB Hole Dia.—1.7mm

Electrical Properties

Maximum Current—15A

Operating Voltage—300V (5mm)

Environmental Properties

Operating Temperature Range—
-30°C to +105°C [-22°F to 221°F] Tin contact system

(vertical solder pins)

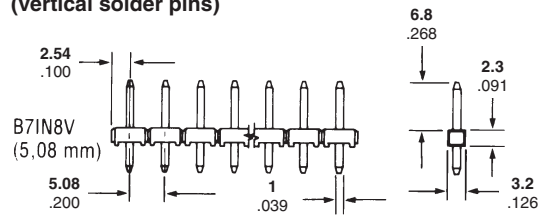

Series B51C8 Plug-in Connector

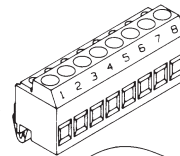

Series B71N8 Vertical Pin Header

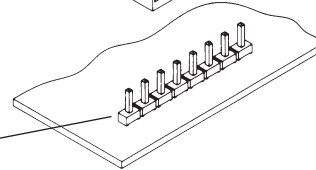

No. of Positions	Part Number	Catalog Number
2	1776453-2	B71N8V02T
3	1776453-3	B71N8V03T
4	1776453-4	B71N8V04T
5	1776453-5	B71N8V05T
6	1776453-6	B71N8V06T
7	1776453-7	B71N8V07T
8	1776453-8	B71N8V08T
9	1776453-9	B71N8V09T
10	1-1776453-0	B71N8V10T
11	1-1776453-1	B71N8V11T
12	1-1776453-2	B71N8V12T
13	—	B71N8V13T
14	1-1776453-4	B71N8V14T
15	—	B71N8V15T
16	1-1776453-6	B71N8V16T
17	1-1776453-7	B71N8V17T
18	1-1776453-8	B71N8V18T
19	—	B71N8V19T
20	2-1776453-0	B71N8V20T
21	—	B71N8V21T
22	2-1776453-2	B71N8V22T
23	—	B71N8V23T
24	2-1776453-4	B71N8V24T



LR28387 E63810

Note: All part numbers are RoHS Compliant.

Wire Protector Versions

Product Facts

- **Modular configuration designed with a dovetail and special detent to provide a more reliable attachment after combining smaller sizes to increase the number of available wire positions**
- **Accepts various wire ranges from 14-22 AWG**
- **Exceptional UL Flammability Classification. All are rated to a flammability classification of UL 94V-0. To achieve the UL94V-0 classification, all materials are tested and proven to be self-extinguishing**
- **UL Recognition File No. E28476**
- **CSA Certification File No. 209071**
- **Pitches Available**
 - **5.0 mm and 5.08 mm Low Profile**
 - **Side and top wire entry**
 - **3.5 mm Side Entry Only**
 - **5.00 mm**
 - **5.0 mm and 5.08 mm 45° wire entry**
- **Various position sizes available**
- **Ink marking available**
- **Other colors available upon request other than those listed in catalog**

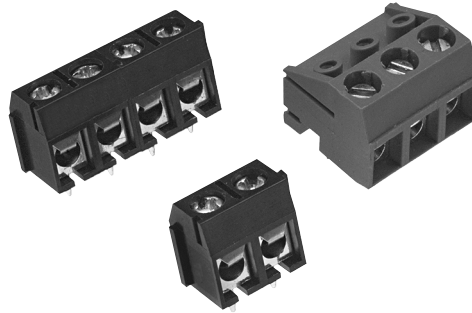

Has full wire guard protection so that the screw does not press directly on the wire. Offers "Lower Profile" terminal block than the cage clamp style. Designed for infrequent terminations.

The screw is able to accommodate both Slot head and Phillips style screwdrivers.

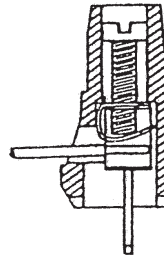

Open

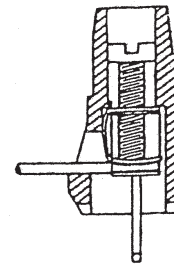

Closed

Note: All part numbers are RoHS Compliant.

PCB Mount, Straight, Top Wire Entry Connectors

**Terminal Block PCB Mount
Top Wire Entry
w/Interlock
5.0 mm Pitch (LT)
Color – Blue
UL Rating – 250 V, 10 A
14-22 AWG**

**Suggested Screw Torque—
4.0 in.-lbs.**

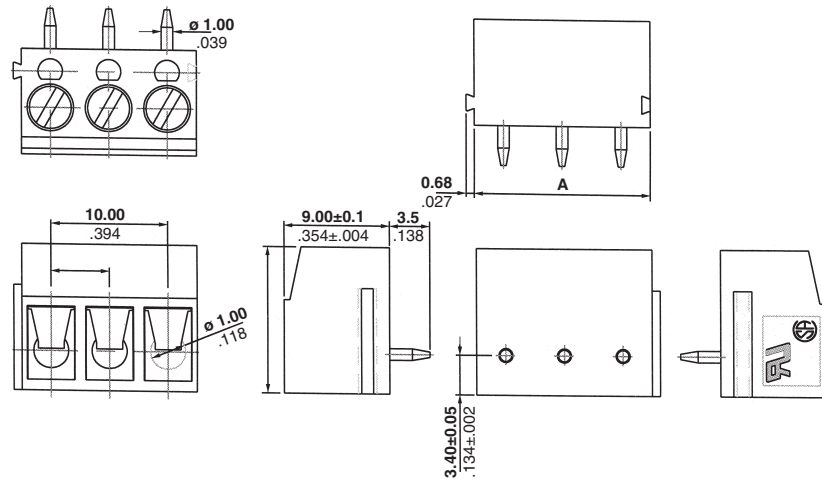

No. of Positions	Dim. A	Part Numbers
2	10.0 [0.394]	1776492-2
3	15.0 [0.591]	1776492-3
4	20.0 [0.787]	1776492-4
5	25.0 [0.984]	1776492-5
6	30.0 [1.181]	1776492-6
7	35.0 [1.378]	1776492-7
8	40.0 [1.575]	1776492-8
9	45.0 [1.772]	1776492-9
10	50.0 [1.968]	1-1776492-0
11	55.0 [2.165]	1-1776492-1
12	60.0 [2.362]	1-1776492-2
13	65.0 [2.559]	1-1776492-3
14	70.0 [2.756]	1-1776492-4
15	75.0 [2.953]	1-1776492-5
16	80.0 [3.150]	1-1776492-6
17	85.0 [3.346]	1-1776492-7
18	90.0 [3.543]	1-1776492-8
19	95.0 [3.740]	1-1776492-9
20	100.0 [3.937]	2-1776492-0
21	105.0 [4.134]	2-1776492-1
22	110.0 [4.331]	2-1776492-2
23	115.0 [4.528]	2-1776492-3
24	120.0 [4.724]	2-1776492-4

Wave solder process capable to 265°C [509°F] for 10 seconds

Note: All part numbers are RoHS Compliant.

PCB Mount, Straight, Top Wire Entry Connectors (Continued)

**Terminal Block PCB Mount
Top Wire Entry
Low Profile w/Interlock
5.0 mm Pitch (LT)
Color – See chart.**

**UL Rating – 250 V, 10 A
14-22 AWG**

**Suggested Screw Torque—
4.5 in.-lbs.**

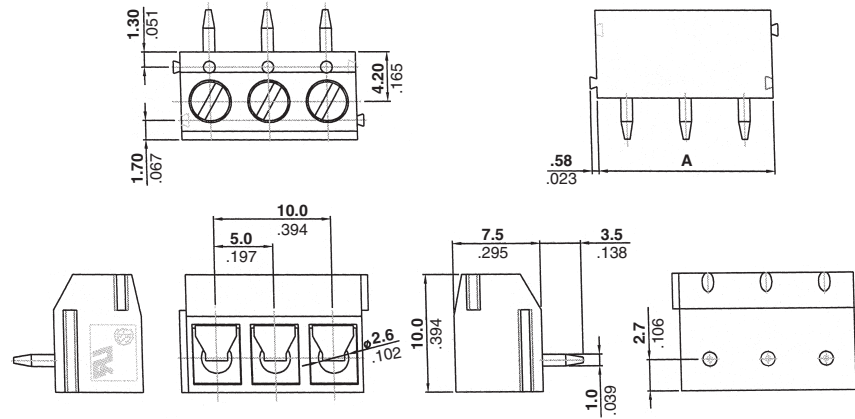

No. of Positions	Dim. A	Part No.	
		Blue	Green
2	10.0 [.394]	1776555-2	1776267-2
3	15.0 [.591]	1776555-3	1776267-3
4	20.0 [.787]	1776555-4	1776267-4
5	25.0 [.984]	1776555-5	1776267-5
6	30.0 [1.181]	1776555-6	1776267-6
7	35.0 [1.378]	1776555-7	1776267-7
8	40.0 [1.575]	1776555-8	1776267-8
9	45.0 [1.772]	1776555-9	1776267-9
10	50.0 [1.968]	1-1776555-0	1-1776267-0
11	55.0 [2.165]	1-1776555-1	1-1776267-1
12	60.0 [2.362]	1-1776555-2	1-1776267-2
13	65.0 [2.559]	1-1776555-3	1-1776267-3
14	70.0 [.591]	1-1776555-4	1-1776267-4
15	75.0 [.787]	1-1776555-5	1-1776267-5
16	80.0 [.984]	1-1776555-6	1-1776267-6
17	85.0 [1.181]	1-1776555-7	1-1776267-7
18	90.0 [1.378]	1-1776555-8	1-1776267-8
19	95.0 [1.575]	1-1776555-9	1-1776267-9
20	100.0 [1.772]	2-1776555-0	2-1776267-0
21	105.0 [1.968]	2-1776555-1	2-1776267-1
22	110.0 [2.165]	2-1776555-2	2-1776267-2
23	115.0 [2.362]	2-1776555-3	2-1776267-3
24	120.0 [2.362]	2-1776555-4	2-1776267-4

Wave solder process capable to 265°C [509°F] for 10 seconds



Note: All part numbers are RoHS Compliant.

PCB Mount, Straight, Side Wire Entry Connectors

**Terminal Block PCB Mount
Side Wire Entry
w/Interlock
3.5 mm Pitch (LT)
Color – Blue**

**UL Rating – 250 V, 7 A
18-26 AWG**

**Suggested Screw Torque—
2.5 in.-lbs.**

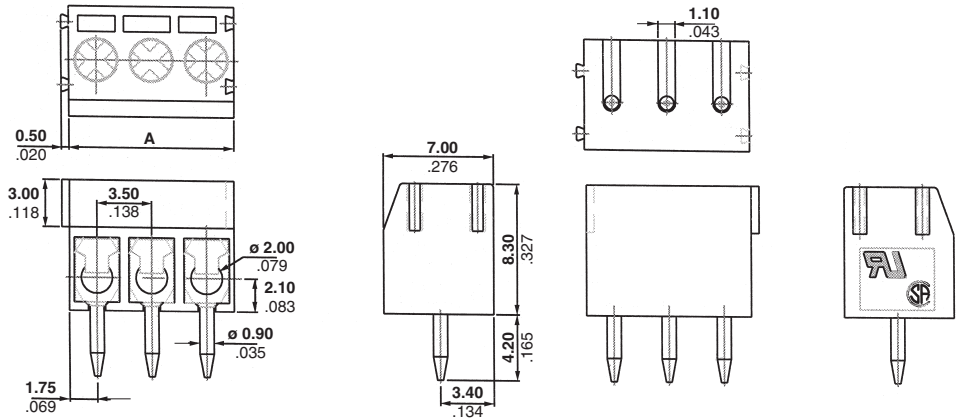

No. of Positions	Dim. A	Part Numbers
2	7.00 [.276]	1776275-2
3	10.50 [.413]	1776275-3
4	14.00 [.551]	1776275-4
5	17.50 [.689]	1776275-5
6	21.00 [.827]	1776275-6
7	24.50 [.965]	1776275-7
8	28.00 [1.102]	1776275-8
9	31.50 [1.240]	1776275-9
10	35.00 [1.378]	1-1776275-0
11	38.50 [1.516]	1-1776275-1
12	42.00 [1.654]	1-1776275-2
13	45.50 [1.791]	1-1776275-3
14	49.00 [1.929]	1-1776275-4
15	52.50 [2.067]	1-1776275-5
16	54.00 [2.126]	1-1776275-6
17	57.50 [2.264]	1-1776275-7
18	61.00 [2.402]	1-1776275-8
19	64.50 [2.539]	1-1776275-9
20	68.00 [2.677]	2-1776275-0
21	71.50 [2.815]	2-1776275-1
22	75.00 [2.953]	2-1776275-2
23	78.50 [3.091]	2-1776275-3
24	82.00 [3.228]	2-1776275-4

Wave solder process capable to 265°C [509°F] for 10 seconds

Note: All part numbers are RoHS Compliant.

PCB Mount, Straight, Side Wire Entry Connectors (Continued)

**Terminal Block PCB Mount
Side Wire Entry
Low Profile w/Interlock
5.0 mm Pitch (LT)**

**UL Rating – 250 V, 10 A
14-22 AWG**

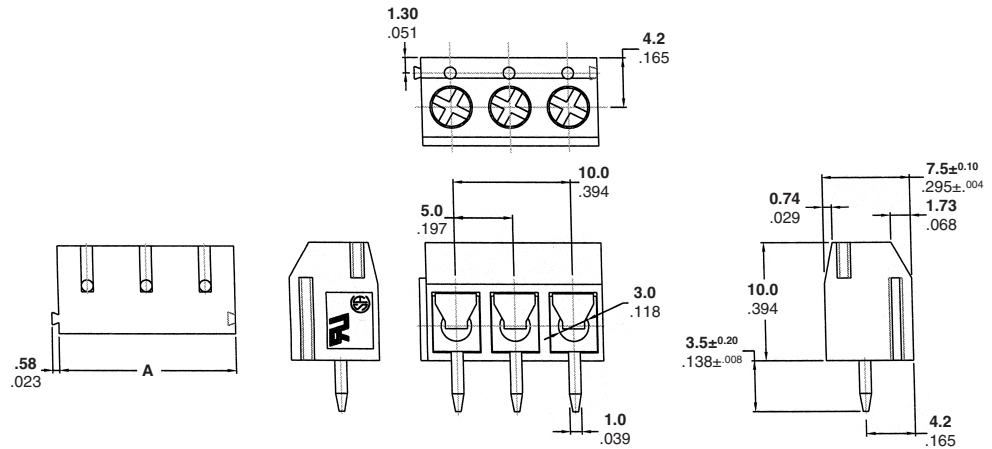

Suggested Screw Torque—
4.5 in.-lbs.

No. of Positions	Dim. A	Part Numbers			
		Blue	Green	Gray	Black
2	10.0 [.394]	1776244-2	1776266-2	1776504-2	1776269-2
3	15.0 [.591]	1776244-3	1776266-3	1776504-3	1776269-3
4	20.0 [.787]	1776244-4	1776266-4	1776504-4	1776269-4
5	25.0 [.984]	1776244-5	1776266-5	1776504-5	1776269-5
6	30.0 [1.181]	1776244-6	1776266-6	1776504-6	1776269-6
7	35.0 [1.378]	1776244-7	1776266-7	1776504-7	1776269-7
8	40.0 [1.575]	1776244-8	1776266-8	1776504-8	1776269-8
9	45.0 [1.772]	1776244-9	1776266-9	1776504-9	1776269-9
10	50.0 [1.968]	1-1776244-0	1-1776266-0	1-1776504-0	1-1776269-0
11	55.0 [2.165]	1-1776244-1	1-1776266-1	1-1776504-1	1-1776269-1
12	60.0 [2.362]	1-1776244-2	1-1776266-2	1-1776504-2	1-1776269-2
13	65.0 [2.559]	1-1776244-3	1-1776266-3	1-1776504-3	1-1776269-3
14	70.0 [.591]	1-1776244-4	1-1776266-4	1-1776504-4	1-1776269-4
15	75.0 [.787]	1-1776244-5	1-1776266-5	1-1776504-5	1-1776269-5
16	80.0 [.984]	1-1776244-6	1-1776266-6	1-1776504-6	1-1776269-6
17	85.0 [1.181]	1-1776244-7	1-1776266-7	1-1776504-7	1-1776269-7
18	90.0 [1.378]	1-1776244-8	1-1776266-8	1-1776504-8	1-1776269-8
19	95.0 [1.575]	1-1776244-9	1-1776266-9	1-1776504-9	1-1776269-9
20	100.0 [1.772]	2-1776244-0	2-1776266-0	2-1776504-0	2-1776269-0
21	105.0 [1.968]	2-1776244-1	2-1776266-1	2-1776504-1	2-1776269-1
22	110.0 [2.165]	2-1776244-2	2-1776266-2	2-1776504-2	2-1776269-2
23	115.0 [2.362]	2-1776244-3	2-1776266-3	2-1776504-3	2-1776269-3
24	120.0 [2.362]	2-1776244-4	2-1776266-4	2-1776504-4	2-1776269-4

Wave solder process capable to 265°C [509°F] for 10 seconds



Note: All part numbers are RoHS Compliant.

PCB Mount, Straight, Side Wire Entry Connectors (Continued)

Terminal Block PCB Mount
Side Wire Entry
w/Interlock
5.00 mm Pitch (LT)
Color – Blue
UL Rating – 250 V, 10 A
14-22 AWG

Suggested Screw Torque—
4.5 in.-lbs.

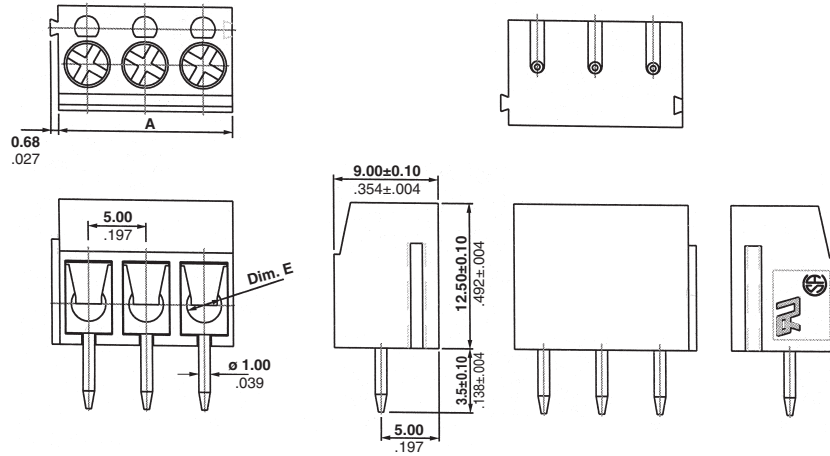

No. of Positions	Dim. A	Part Numbers
2	10.00 [.394]	1776491-2
3	15.00 [.591]	1776491-3
4	20.00 [.787]	1776491-4
5	25.00 [.984]	1776491-5
6	30.00 [1.181]	1776491-6
7	35.00 [1.378]	1776491-7
8	40.00 [1.575]	1776491-8
9	45.00 [1.772]	1776491-9
10	50.00 [1.969]	1-1776491-0
11	55.00 [2.165]	1-1776491-1
12	60.00 [2.362]	1-1776491-2
13	65.00 [2.559]	1-1776491-3
14	70.00 [2.756]	1-1776491-4
15	75.00 [2.953]	1-1776491-5
16	80.00 [3.150]	1-1776491-6
17	85.00 [3.346]	1-1776491-7
18	90.00 [3.543]	1-1776491-8
19	95.00 [3.740]	1-1776491-9
20	100.00 [3.937]	2-1776491-0
21	105.00 [4.134]	2-1776491-1
22	110.00 [4.331]	2-1776491-2
23	115.00 [4.525]	2-1776491-3
24	120.00 [4.724]	2-1776491-4

Wave solder process capable to 265°C [509°F] for 10 seconds

45° Wire Inlet Connectors

Terminal Block
45° Wire Inlet w/Interlock
5.00 mm Pitch (LT)
Color – Blue
UL Rating – 250 V, 10 A
14-22 AWG

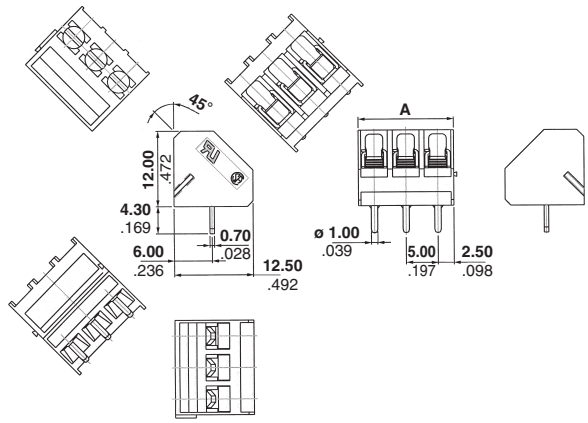

Suggested Screw Torque—
4.0 in.-lbs.

No. of Positions	Dim. A	Part Numbers
2	10.00 [.394]	1776252-2
3	15.00 [.591]	1776252-3
4	20.00 [.787]	1776252-4
5	25.00 [.984]	1776252-5
6	30.00 [1.181]	1776252-6
7	35.00 [1.378]	1776252-7
8	40.00 [1.575]	1776252-8
9	45.00 [1.772]	1776252-9
10	50.00 [1.969]	1-1776252-0
11	55.00 [2.165]	1-1776252-1
12	60.00 [2.362]	1-1776252-2
13	65.00 [2.559]	1-1776252-3

No. of Positions	Dim. A	Part Numbers
14	70.00 [2.756]	1-1776252-4
15	75.00 [2.953]	1-1776252-5
16	80.00 [3.150]	1-1776252-6
17	85.00 [3.346]	1-1776252-7
18	90.00 [3.543]	1-1776252-8
19	95.00 [3.740]	1-1776252-9
20	100.00 [3.937]	2-1776252-0
21	105.00 [4.134]	2-1776252-1
22	110.00 [4.331]	2-1776252-2
23	115.00 [4.528]	2-1776252-3
24	120.00 [4.724]	2-1776252-4

Wave solder process capable to 265°C [509°F] for 10 seconds

Terminal Block
45° Wire Inlet w/Interlock
5.08 mm Pitch (LT)
Color – Blue
UL Rating – 250 V, 10 A
14-22 AWG

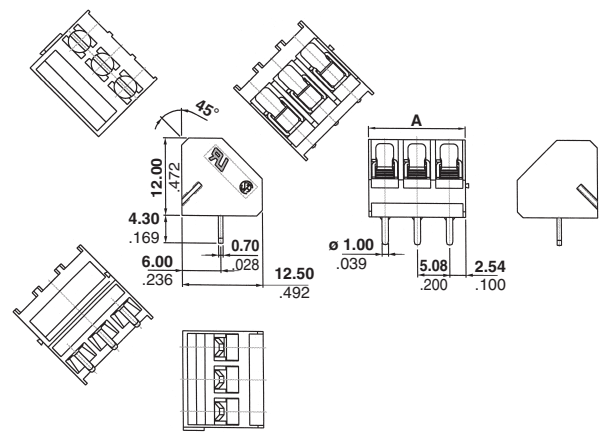

Suggested Screw Torque—
4.0 in.-lbs.

No. of Positions	Dim. A	Part Numbers
2	10.16 [.400]	1776258-2
3	15.24 [.600]	1776258-3
4	20.32 [.800]	1776258-4
5	25.40 [1.000]	1776258-5
6	30.48 [1.200]	1776258-6
7	35.56 [1.400]	1776258-7
8	40.64 [1.600]	1776258-8
9	45.72 [1.800]	1776258-9
10	50.80 [2.000]	1-1776258-0
11	55.88 [2.200]	1-1776258-1
12	60.96 [2.400]	1-1776258-2
13	66.04 [2.600]	1-1776258-3

No. of Positions	Dim. A	Part Numbers
14	71.12 [2.800]	1-1776258-4
15	76.20 [3.000]	1-1776258-5
16	81.28 [3.200]	1-1776258-6
17	86.36 [3.400]	1-1776258-7
18	91.44 [3.600]	1-1776258-8
19	96.52 [3.800]	1-1776258-9
20	101.60 [4.000]	2-1776258-0
21	106.68 [4.200]	2-1776258-1
22	111.76 [4.400]	2-1776258-2
23	116.84 [4.600]	2-1776258-3
24	121.92 [4.800]	2-1776258-4

Wave solder process capable to 265°C [509°F] for 10 seconds



Note: All part numbers are RoHS Compliant.

Plug, Flush Mount

**Plug
Flush Mount
5.00 mm Pitch
Color – See chart.**

**UL Rating – 250/300 V, 10 A
14-22 AWG**

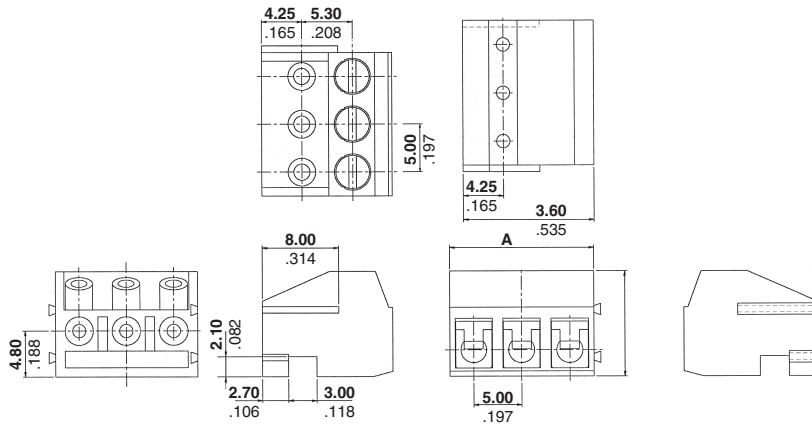

Suggested Screw Torque—
4.5 in.-lbs.

No. of Positions	Dim. A	Part No.	
		Black	Blue
2	10.00 [.394]	1776280-2	1776263-2
3	15.00 [.591]	1776280-3	1776263-3
4	20.00 [.787]	1776280-4	1776263-4
5	25.00 [.984]	1776280-5	1776263-5
6	30.00 [1.181]	1776280-6	1776263-6
7	35.00 [1.378]	1776280-7	1776263-7
8	40.00 [1.575]	1776280-8	1776263-8
9	45.00 [1.772]	1776280-9	1776263-9
10	50.00 [1.969]	1-1776280-0	1-1776263-0
11	55.00 [2.165]	1-1776280-1	1-1776263-1
12	60.00 [2.362]	1-1776280-2	1-1776263-2
13	65.00 [2.559]	1-1776280-3	1-1776263-3

No. of Positions	Dim. A	Part No.	
		Black	Blue
14	70.00 [2.756]	1-1776280-4	1-1776263-4
15	75.00 [2.953]	1-1776280-5	1-1776263-5
16	80.00 [3.150]	1-1776280-6	1-1776263-6
17	85.00 [3.346]	1-1776280-7	1-1776263-7
18	90.00 [3.543]	1-1776280-8	1-1776263-8
19	95.00 [3.740]	1-1776280-9	1-1776263-9
20	100.00 [3.937]	2-1776280-0	2-1776263-0
21	105.00 [4.134]	2-1776280-1	2-1776263-1
22	110.00 [4.331]	2-1776280-2	2-1776263-2
23	115.00 [4.528]	2-1776280-3	2-1776263-3
24	120.00 [4.724]	2-1776280-4	2-1776263-4

Header, Straight Mount

**Header
Straight Mount,
Unshrouded
5.00 mm Pitch
Color – Blue
UL Rating – 250/300 V, 10 A**

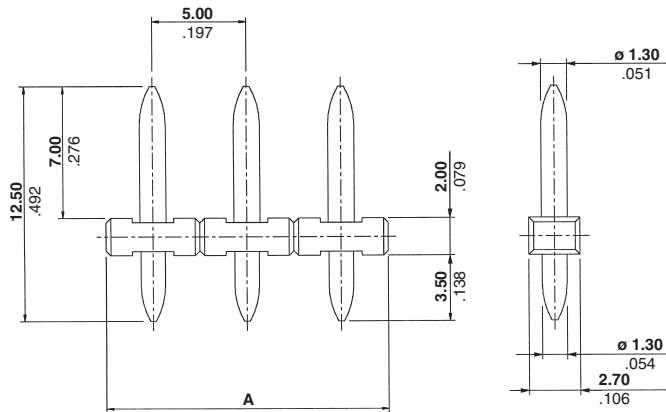

No. of Positions	Dim. A	Part Numbers
2	10.00 [.394]	1776489-2
3	15.00 [.591]	1776489-3
4	20.00 [.787]	1776489-4
5	25.00 [.984]	1776489-5
6	30.00 [1.181]	1776489-6
7	35.00 [1.378]	1776489-7
8	40.00 [1.575]	1776489-8
9	45.00 [1.772]	1776489-9
10	50.00 [1.969]	1-1776489-0
11	55.00 [2.165]	1-1776489-1
12	60.00 [2.362]	1-1776489-2
13	65.00 [2.559]	1-1776489-3

No. of Positions	Dim. A	Part Numbers
14	70.00 [2.756]	1-1776489-4
15	75.00 [2.953]	1-1776489-5
16	80.00 [3.150]	1-1776489-6
17	85.00 [3.346]	1-1776489-7
18	90.00 [3.543]	1-1776489-8
19	95.00 [3.740]	1-1776489-9
20	100.00 [3.937]	2-1776489-0
21	105.00 [4.134]	2-1776489-1
22	110.00 [4.331]	2-1776489-2
23	115.00 [4.528]	2-1776489-3
24	120.00 [4.724]	2-1776489-4

Wave solder process capable to 265°C [509°F] for 10 seconds

Note: All part numbers are RoHS Compliant.

Wire Trap

2.5 mm Pitch

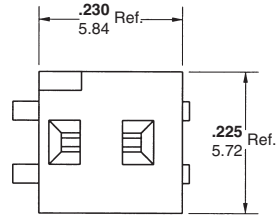
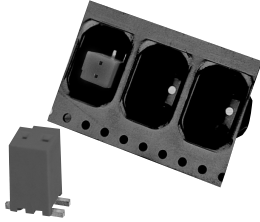

2.5 mm Surface Mount, Technology with Wire Trap, Series SMC

Material & Finish

Housing Material—Polyphenylene Sulfide (PPS)

Flammability—UL94V-0

Color—Black

Contact—Phosphor bronze, tin plated over nickel

Mechanical Properties

Pitch (terminal spacing)—2.5mm [.098]

Wire Strip Length—5.5mm min, 7.11mm max. [0.22" min, 0.28" max]

Max. Wire Insulation Diameter—1.7mm [.067]

Packaging—Tape and reel and loose piece

Electrical Properties

Maximum Current—3A

Operating Voltage—250V

Wire Range—24 AWG, stranded tin

Dielectric Withstand—1500 VAC

Environmental Properties

Max. Operating Temperature—105°C [221°F]

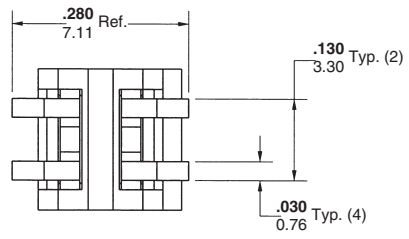
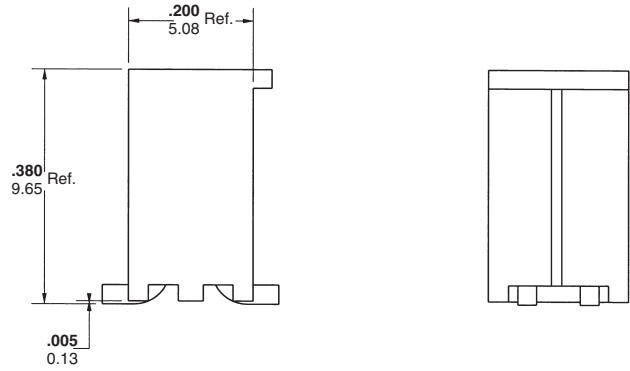

Surface Mount with Wire Trap

Product Facts

- n Available in 2.5 mm pitch
- n Accepts 24 AWG stranded tin
- n 2 position Connector
- n Current capability: 3 A
- n 250 V
- n Packaging: Tape and Reel and Loose Piece (25 pcs/bag)

Description	No. of Positions	Part Number	Catalog Number
Tape & Reel, 500 pieces	2	1776226-1	SMC2402
25 pieces	2	1776227-1	SM2V02

Note: All part numbers are RoHS Compliant.

PIVOT BLOCK 3.5 mm Plugs

Product Facts

- 3.5 mm [.138] centerline IDC plug
- Alternative to screw clamp plugs
- Two-piece pluggable terminal block system
- Mates with 3.5 mm horizontal and vertical terminal block headers on pages 45, 47, 49 and 58
- Proven pivot wire termination
- Multi-position connector, IDC termination and tactile feel when terminated
- No wire stripping required
- Flanged version available
- Designs available to terminate solid and stranded wires: 22-24 AWG (2-16 positions)
- Wire stuffer allows visual inspection of wire termination
- Screwdriver required to open wire stuffer

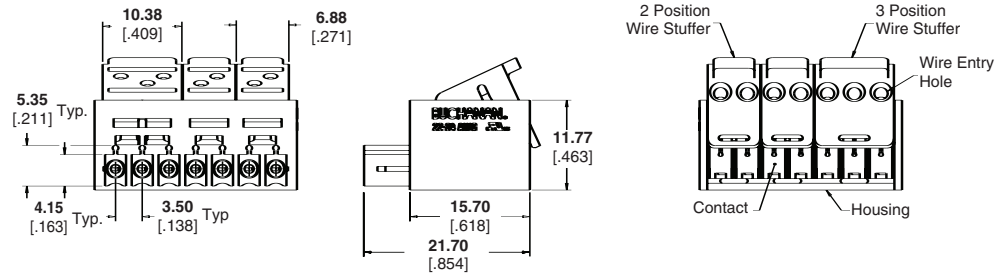
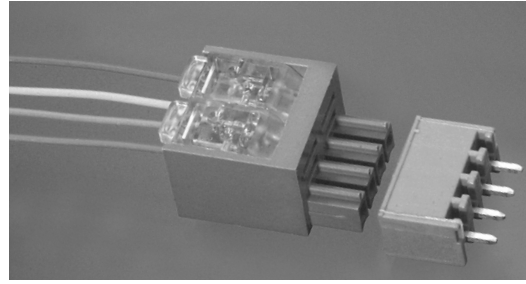

Material and Finish

- Wire Stuffer**—Polycarbonate
- Housing**—PBT Polyester, Green (standard color), blue also available
- Contact**—Phosphor Bronze
- Plating**—Tin over Nickel

Performance Characteristics

Mechanical Properties

- 10 cycles min. durability wire termination
- 15 lbs. closing force max. (2 position)
- 10 lbs. opening force max. (2 position)
- Screws for mounting flange M2.5 fixing screw

Electrical Properties

- Maximum current 5A (22-24 AWG)
- Operating voltage 250 V
- Dielectric withstanding 1500 VAC

Technical Documents

Product Specification:
108-1981

Application Specification:
114-13037

No. of Positions	Description	22-24 AWG	
		Part Number Blue	Part Number Green
2	IDC T/B	1776279-2	1776282-2
	IDC T/B with Screw Flange	1776281-2	1776283-2
3	IDC T/B	1776279-3	1776282-3
	IDC T/B with Screw Flange	1776281-3	1776283-3
4	IDC T/B	1776279-4	1776282-4
	IDC T/B with Screw Flange	1776281-4	1776283-4
5	IDC T/B	1776279-5	1776282-5
	IDC T/B with Screw Flange	1776281-5	1776283-5
6	IDC T/B	1776279-6	1776282-6
	IDC T/B with Screw Flange	1776281-6	1776283-6
7	IDC T/B	1776279-7	1776282-7
	IDC T/B with Screw Flange	1776281-7	1776283-7
8	IDC T/B	1776279-8	1776282-8
	IDC T/B with Screw Flange	1776281-8	1776283-8
9	IDC T/B	1776279-9	1776282-9
	IDC T/B with Screw Flange	1776281-9	1776283-9
10	IDC T/B	1-1776279-0	1-1776282-0
	IDC T/B with Screw Flange	1-1776281-0	1-1776283-0
11	IDC T/B	1-1776279-1	1-1776282-1
	IDC T/B with Screw Flange	1-1776281-1	1-1776283-1
12	IDC T/B	1-1776279-2	1-1776282-2
	IDC T/B with Screw Flange	1-1776281-2	1-1776283-2
13	IDC T/B	1-1776279-3	1-1776282-3
	IDC T/B with Screw Flange	1-1776281-3	1-1776283-3
14	IDC T/B	1-1776279-4	1-1776282-4
	IDC T/B with Screw Flange	1-1776281-4	1-1776283-4
15	IDC T/B	1-1776279-5	1-1776282-5
	IDC T/B with Screw Flange	1-1776281-5	1-1776283-5
16	IDC T/B	1-1776279-6	1-1776282-6
	IDC T/B with Screw Flange	1-1776281-6	1-1776283-6

Note: All part numbers are RoHS Compliant.

Vertical Screwless Wire Connectors

Product Facts

- Contact design allows for retermination
- Terminates 16-18 AWG solid wire and 18 AWG bonded wire
- Through-hole solder mount with kinked legs for PCB retention

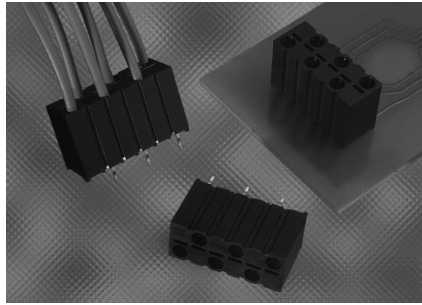

Material and Finish

Housing—UL94V-0 rated PBT
Contact—Phosphor Bronze
Contact Finish—Pre-tin over nickel underplate

Performance Characteristics

Mechanical Properties

5 cycles min. durability wire termination
Wire Retention—5 lb. [22.25N]
Pitch—.138 [3.5 mm] staggered centerline

Electrical Properties

Maximum current 2A
 Operating voltage 600 V
 Dielectric withstanding 2200 VAC

Technical Documents

Product Specification:
108-2059

Application Specification:
114-13075

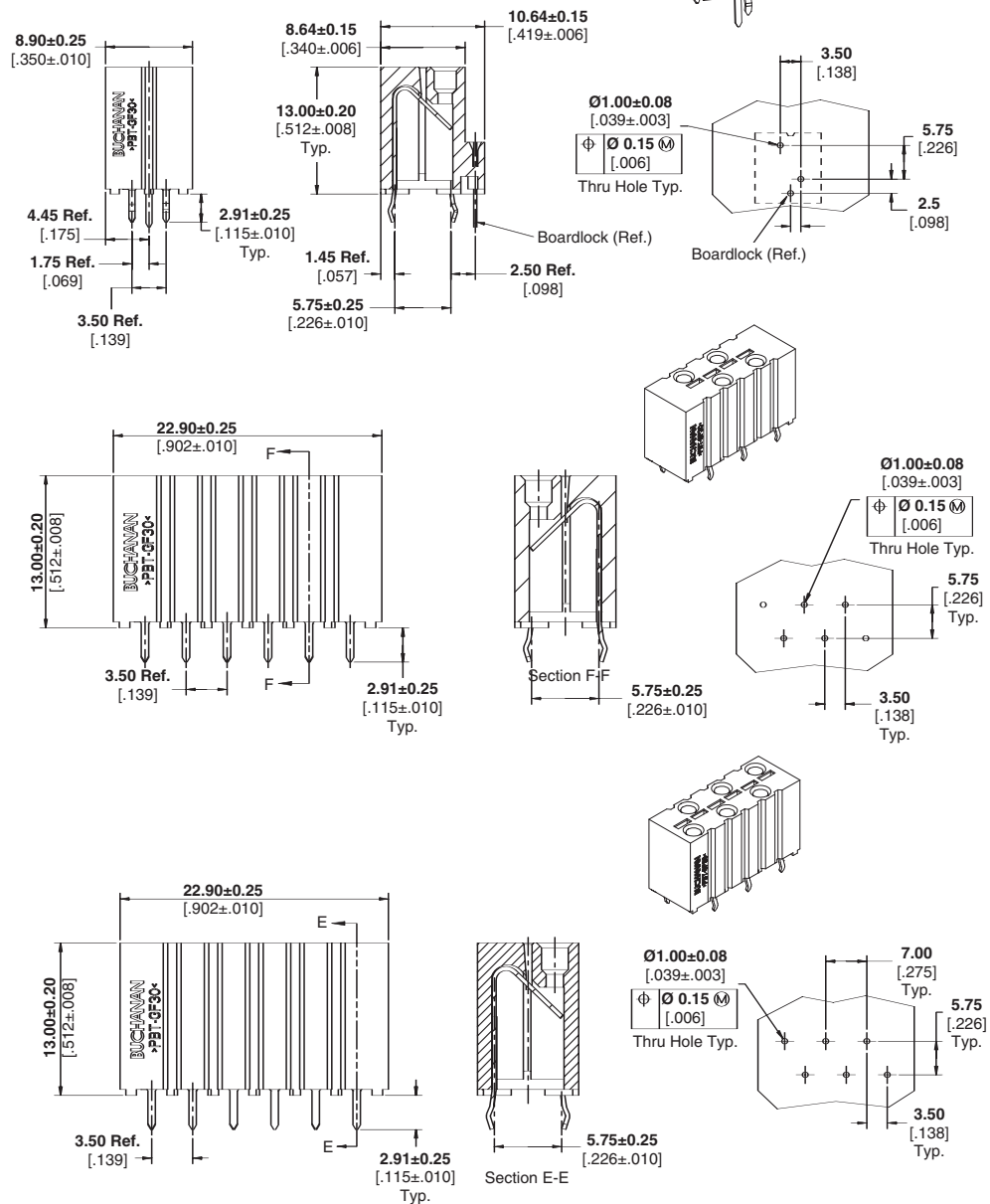



No. of Positions	Description	Part Numbers
2	W/Boardlock	1811957-1
4	—	1811444-1
6	—	1811398-1

Note: All part numbers are RoHS Compliant.

Screwless Terminal Blocks

Product Facts

- n Available in 5.0 mm [.197] and 5.08 mm [.200] pitch sizes
- n Wire range 14-22 AWG
- n Current capability: 10 A (5.08 mm [.200] lever version)
- n Vertical and right-angle wire insertion provides options to meet different application needs
- n No special tool required, levers can be easily actuated with a finger or a screwdriver
- n Screwless saves time when installing wires
- n UL Recognition 
- n CSA Certification 

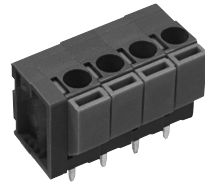

5.0 mm and 5.08 mm Pitch (Pages 104, 105)

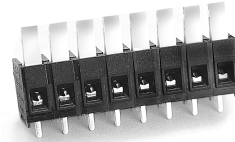

Series 2SV 5.08 mm Pitch (Below)

Screwless Terminal Blocks are suitable for both solid and stranded wires and offers a fast way to complete wire connections. The lever is fully integrated into the body of the terminal

block, which means no special tools are required.

The spring is made from stainless steel strip so that there is a strong connection.

5.08 mm Standard Connectors with Screwless Clamp Series 2SV

Material & Finish

Housing Material—Thermoplastic polyester

Flammability—UL94V-0

Color—Black

Clamping Terminal and Solder Pin— Acid-tin over copper alloy

Mechanical Properties

Pitch (terminal spacing)— 5.08mm [.200]

Recommended PCB Hole Dia.— 1.4mm [.055]

Electrical Properties

Maximum Current—10 A

Operating Voltage—150/300V (limited ratings)

Wire Range—18-22 AWG

Environmental Properties

Max. Operating Temperature— 130°C [266°F]

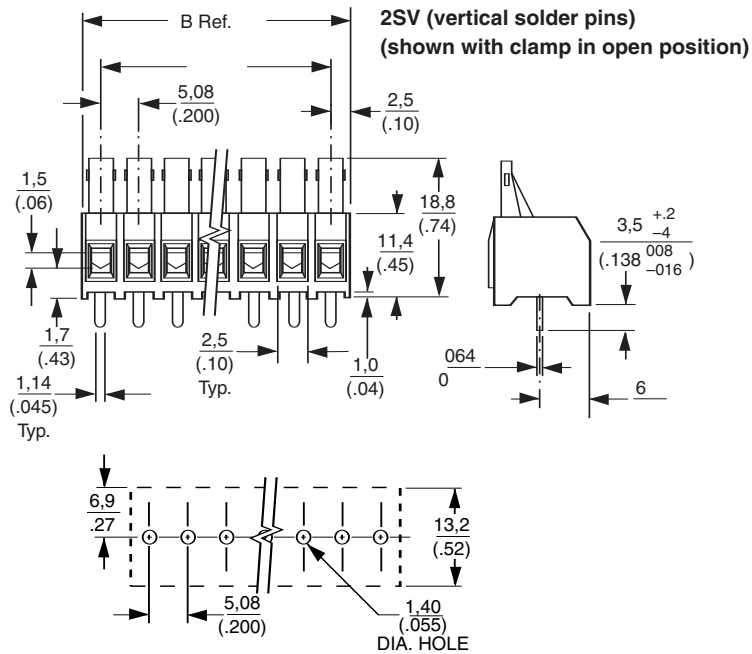

No. of Positions	Dimensions		Part Number	Catalog Number
	A	B		
2	0.2 [5.1]	0.4 [10.2]	1437671-1	2SV-02
3	0.4 [10.2]	0.6 [15.2]	1437671-4	2SV-03
4	0.6 [15.2]	0.8 [20.3]	1437671-6	2SV-04
5	0.8 [20.3]	1.0 [25.4]	1437671-7	2SV-05
6	1.0 [25.4]	1.2 [30.5]	1437671-9	2SV-06
7	1.2 [30.5]	1.4 [35.6]	1-1437671-0	2SV-07
8	1.4 [35.6]	1.6 [40.6]	1-1437671-1	2SV-08
9	1.6 [40.6]	1.8 [45.7]	1-1437671-2	2SV-09
10	1.8 [45.7]	2.0 [50.8]	1-1437671-3	2SV-10
11	2.0 [50.8]	2.2 [55.9]	1-1437671-4	2SV-11
12	2.2 [55.9]	2.4 [61.0]	1-1437671-5	2SV-12
13	2.4 [61.0]	2.6 [66.0]	1-1437671-6	2SV-13
14	2.6 [66.0]	2.8 [71.1]	1-1437671-9	2SV-14
15	2.8 [71.1]	3.0 [76.2]	2-1437671-0	2SV-15
16	3.0 [76.2]	3.2 [81.3]	2-1437671-1	2SV-16

Note: All part numbers are RoHS Compliant.

Screwless, Side Wire Entry Connectors

**Board Mount Screwless,
5.0 mm Pitch,
Side Wire Entry,
Terminal Block
Color – Green**

**UL Rating – 300 V, 10 A
14-22 AWG**

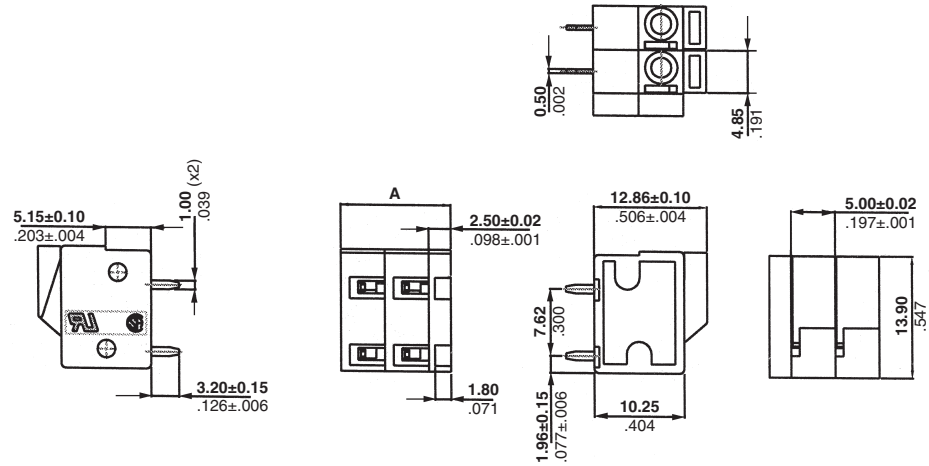

No. of Positions	Dim. A	Part Numbers
2	12.50 [.492]	1776261-2
3	17.50 [.689]	1776261-3
4	22.50 [.886]	1776261-4
5	27.50 [1.083]	1776261-5
6	32.50 [1.280]	1776261-6
7	37.50 [1.476]	1776261-7
8	42.50 [1.673]	1776261-8
9	47.50 [1.870]	1776261-9
10	52.20 [2.055]	1-1776261-0
11	57.50 [2.264]	1-1776261-1
12	62.50 [2.461]	1-1776261-2

Wave solder process capable to 265°C [509°F] for 10 seconds

**Board Mount Screwless,
5.08 mm Pitch,
Side Wire Entry,
Terminal Block
Color – Green**

**UL Rating – 300 V, 10 A
14-22 AWG**

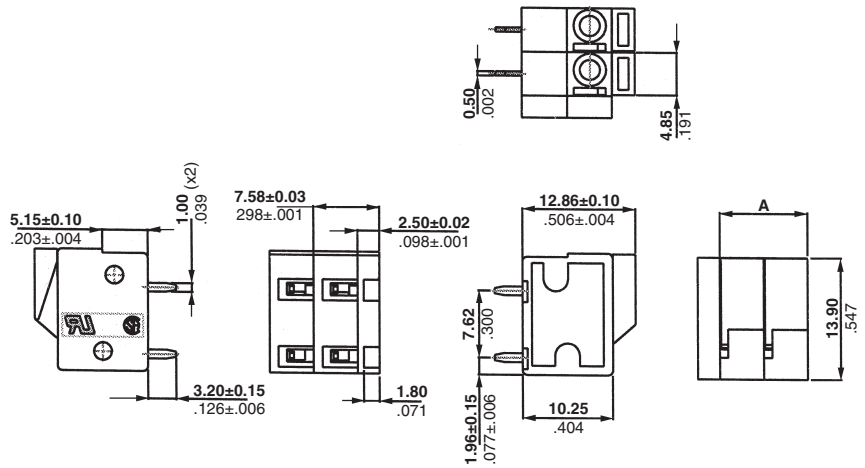

No. of Positions	Dim. A	Part Numbers
2	10.16 [.400]	1776262-2
3	15.24 [.600]	1776262-3
4	20.32 [.800]	1776262-4
5	25.40 [1.000]	1776262-5
6	30.48 [1.200]	1776262-6
7	35.56 [1.400]	1776262-7
8	40.64 [1.600]	1776262-8
9	45.72 [1.800]	1776262-9
10	50.80 [2.000]	1-1776262-0
11	55.88 [2.200]	1-1776262-1
12	60.96 [2.400]	1-1776262-2

Wave solder process capable to 265°C [509°F] for 10 seconds



Note: All part numbers are RoHS Compliant.

Screwless, Top Wire Entry Connectors

**Board Mount Screwless,
5.0 mm Pitch,
Top Wire Entry,
Terminal Block
Color – Green**

**UL Rating – 300 V, 10 A
14-22 AWG**

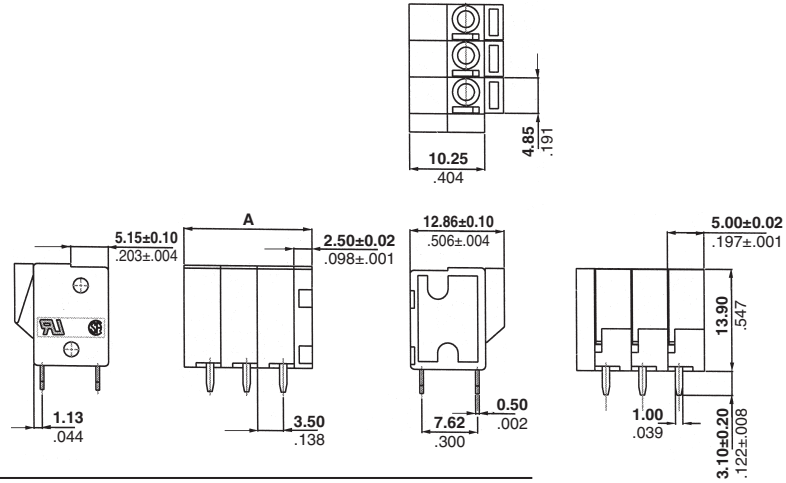

No. of Positions	Dim. A	Part Numbers
2	12.50 [.492]	1776259-2
3	17.50 [.689]	1776259-3
4	22.50 [.886]	1776259-4
5	27.50 [1.083]	1776259-5
6	32.50 [1.280]	1776259-6
7	37.50 [1.476]	1776259-7
8	42.50 [1.673]	1776259-8
9	47.50 [1.870]	1776259-9
10	52.20 [2.055]	1-1776259-0
11	57.50 [2.264]	1-1776259-1
12	62.50 [2.461]	1-1776259-2

Wave solder process capable to 265°C [509°F] for 10 seconds

**Board Mount Screwless,
5.08 mm Pitch,
Top Wire Entry,
Terminal Block
Color – Green**

**UL Rating – 300 V, 10 A
14-22 AWG**

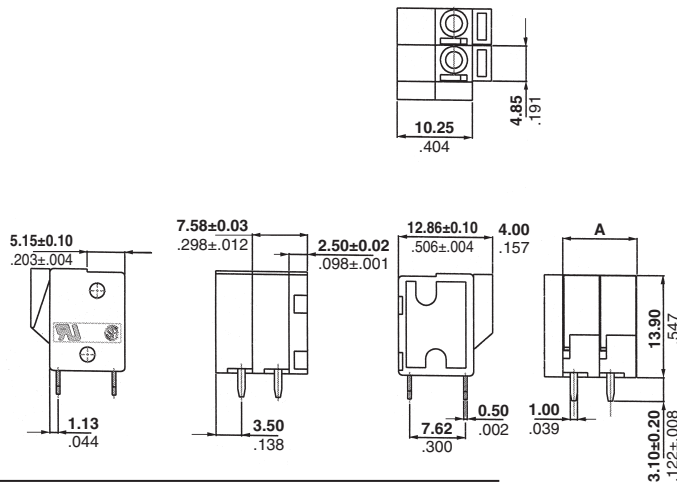

No. of Positions	Dim. A	Part Numbers
2	10.16 [.400]	1776260-2
3	15.24 [.600]	1776260-3
4	20.32 [.800]	1776260-4
5	25.40 [1.000]	1776260-5
6	30.48 [1.200]	1776260-6
7	35.56 [1.400]	1776260-7
8	40.64 [1.600]	1776260-8
9	45.72 [1.800]	1776260-9
10	50.80 [2.000]	1-1776260-0
11	55.88 [2.200]	1-1776260-1
12	60.96 [2.400]	1-1776260-2

Wave solder process capable to 265°C [509°F] for 10 seconds

Note: All part numbers are RoHS Compliant.

Labeling

Labeling

If you need to number Terminal Block connectors, Tyco Electronics makes available an easy-to-use numbering system based on adhesive labels with proper centerline.

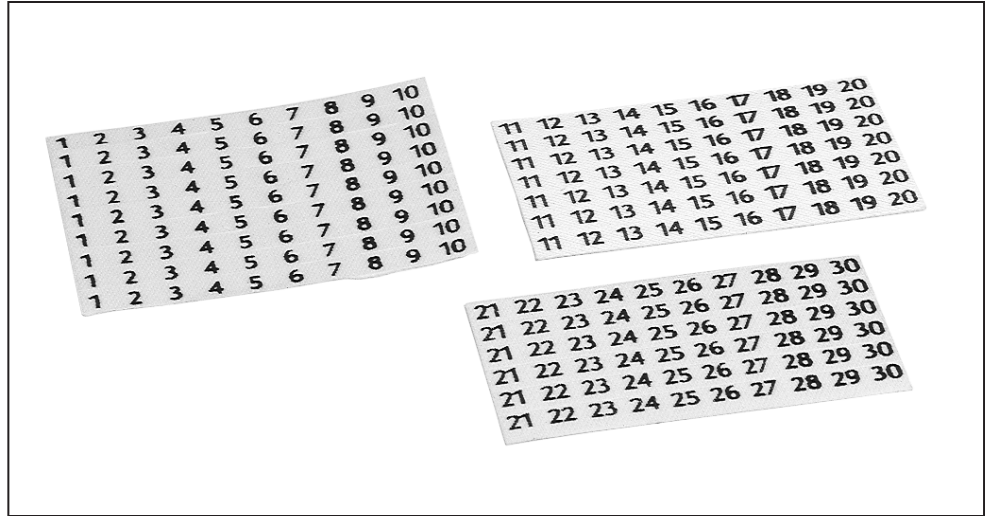

Centerline	Number of Positions	Numbering from...up to	Part Numbers
3.5 [.138]	10	1 ... 10	284627-1
3.5 [.138]	10	11 ... 20	284627-2
3.5 [.138]	10	21 ... 30	284627-3
3.5 [.138]	10	31 ... 40	284627-4
3.5 [.138]	10	41 ... 50	284627-5
3.5 [.138]	10	51 ... 60	284627-6
3.81 [.150]	10	1 ... 10	284628-1
3.81 [.150]	10	11 ... 20	284628-2
3.81 [.150]	10	21 ... 30	284628-3
3.81 [.150]	10	31 ... 40	284628-4
3.81 [.150]	10	41 ... 50	284628-5
3.81 [.150]	10	51 ... 60	284628-6
5.0-5.08 [.197-.200]	10	1 ... 10	282928-1
5.0-5.08 [.197-.200]	10	11 ... 20	282928-2
5.0-5.08 [.197-.200]	10	21 ... 30	282928-3
5.0-5.08 [.197-.200]	10	31 ... 40	282928-4
5.0-5.08 [.197-.200]	10	41 ... 50	282928-5
5.0-5.08 [.197-.200]	10	51 ... 60	282928-6
7.5-7.62 [.295-.300]	10	1 ... 10	282930-1
7.5-7.62 [.295-.300]	10	11 ... 20	282930-2
7.5-7.62 [.295-.300]	10	21 ... 30	282930-3
10.0-10.16 [.394-.400]	10	1 ... 10	282929-1
10.0-10.16 [.394-.400]	10	11 ... 20	282929-2
10.0-10.16 [.394-.400]	10	21 ... 30	282929-3

There are 12 adhesive labels per sheet. Please ask for customized labeling.

Note: All part numbers are RoHS Compliant.

Accessories

Polarization Keys

Polarization keys help prevent wrong mating of two-piece Terminal Block connectors (not valid for special version).

Special keys allow you to differentiate counterparts, meeting OEMs' requirement for error-free interconnections.

Color – Red

For Plugs

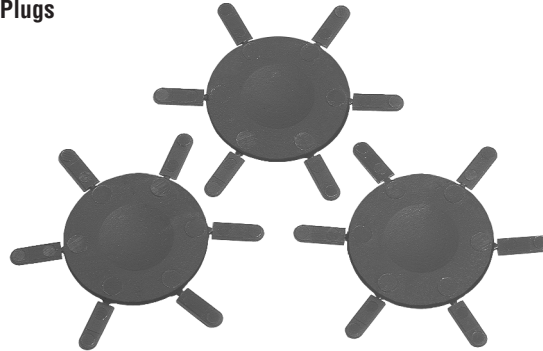

For Headers

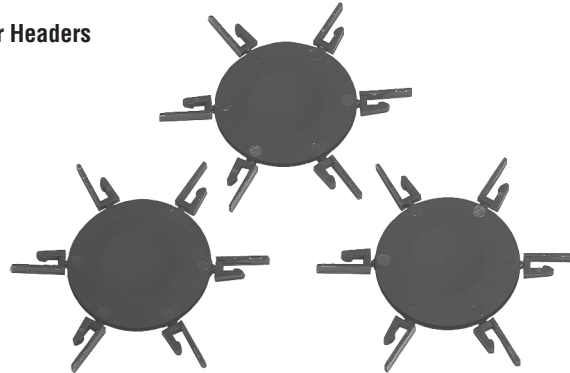

Application	Part Number*
Two-piece Terminal Block Plugs	282969-1
Two-piece Terminal Block Headers	282970-1
3.5, 3.81 mm [.138, .150] Plug	1546050-1
3.5, 3.81 mm [.138, .150] Header	1546051-1

*Comprised of 1 Circular Carrier with 6 Keys.

Screwdrivers

Screwdrivers are additional accessories to facilitate the application of Terminal Block stacking connectors.

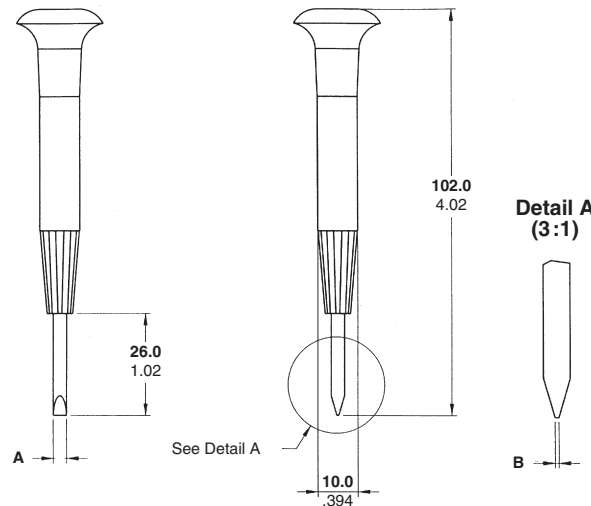

Screw	Dimensions		Part Number
	A	B	
M 1.6 [.063]	1.8 [.071]	0.3 [.012]	785730-1
M 3.0 [.118]	2.5 [.098]	0.6 [.024]	785730-2

Accessories (Continued)

PLASTI-GRIP

Wire Pins

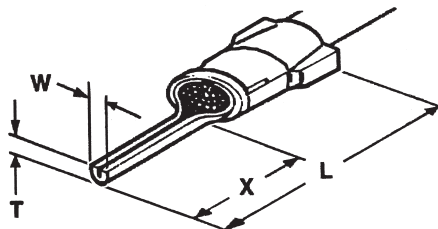

Wire Size Range AWG	Wire Size (mm ²)	DIN Wire Size Range (mm ²)	Insulation Diameter Max. (mm ²)	Insulation Color	Dimensions				Part Number	Packaging Unit	CERTI-CRIMP Hand Tool	
					X	W	T	L				
22-16	0.25-1.60	0.35-0.50-0.75- 1.00-1.50	0.5-1.0	3.7	Red	9.9 [.390]	1.8 [.071]	1.8 [.071]	23.8 [.937]	165167-0	100	47386
16-14	1.00-2.60	1.0-1.5-2.5	>1.0-2.5	4.9	Blue	6.7 [.264]	1.8 [.071]	1.8 [.071]	20.7 [.815]	165075	100	47387-7
						9.9 [.390]	1.8 [.071]	1.8 [.071]	23.7 [.933]	165171	100	47387-7
12-10	2.70-6.60	4.0-6.0	>2.5-6.0	6.4	Yellow	9.9 [.390]	2.6 [.102]	2.6 [.102]	29.2 [1.150]	165085-0	100	59239-4

PIDG

Wire Pins

Material and Finish

Pin – Copper, tin plated
Insulation Sleeve –
Nylon

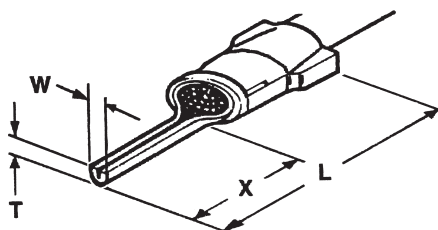

Wire Size Range AWG	Wire Size (mm ²)	DIN Wire Size Range (mm ²)	Insulation Diameter Max. (mm ²)	Insulation Color	Dimensions				Part Number	Packaging Unit	CERTI-CRIMP Hand Tool	
					X	W	T	L				
26-22	0.10-0.40	0.14-0.20- 0.25-0.35	0.14-0.35	2.1	Yellow	6.7 [.264]	1.1 [.043]	1.1 [.043]	18.2 [.717]	165514-1	500	46121
22-16	0.25-1.60	0.35-0.50-0.75- 1.00-1.50	0.5-1.0	3.6	Red	6.7 [.264]	1.8 [.071]	1.8 [.071]	19.7 [.776]	165142-0	500	47386
						9.9 [.390]	1.9 [.075]	1.8 [.071]	22.9 [.902]	165168-0	500	47386
						6.7 [.264]	1.8 [.071]	1.8 [.071]	20.3 [.799]	165046-0	500	47387-7
16-14	1.00-2.60	1.0-1.5-2.5	>1.0-2.5	4.3	Blue	9.9 [.390]	1.8 [.071]	1.8 [.071]	23.6 [.929]	165172-0	500	47387-7
						15.2 [.598]	2.7 [.106]	2.3 [.091]	29.1 [1.146]	9-160402-2	500	47387-7
12-10	2.70-6.60	4.0-6.0	>2.5-6.0	6.4	Yellow	9.9 [.390]	2.6 [.102]	2.6 [.102]	28.5 [1.122]	165049-0	500	59239-4

Related Product Data

For more information on AMP
Standard Terminals and Splices or
Quick-Connect FASTON Receptacles
and Tabs, request Catalog 82042.

Note: All part numbers are RoHS Compliant.

Accessories (Continued)

Wire Ferrules

These Wire Ferrules, suitable for the most common wire range of 0.5 mm² through 10.0 mm², [20AWG-7AWG] are terminated with hand tools.

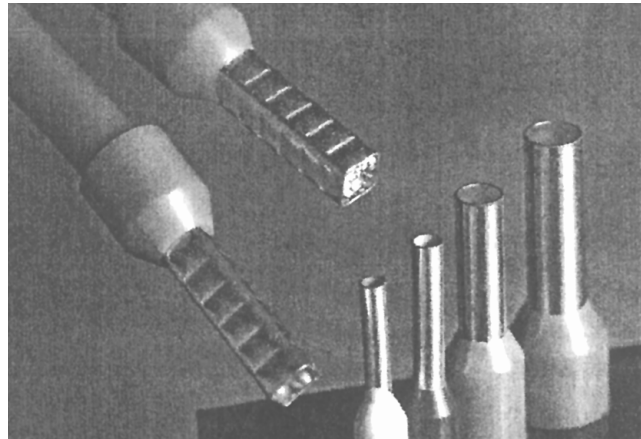

**DIN Wire Ferrules
Tubing Form
with Plastic Sleeve
According to DIN 46228,
Part 4**

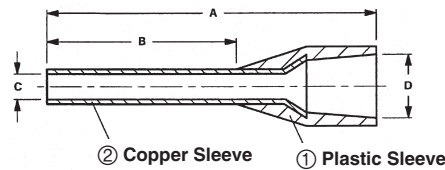

Wire Size Range AWG (mm ²)	Insulation Diameter Max	Version	Insulation Color	Dimensions				Strip Length	Part Number	Packaging Unit	
				A	B	C	D				
20	0.50	2.3 [.091]	Normal	White	14.0 [.551]	8.0 [.315]	1.0 [.039]	2.6 [.102]	10.0 [.394]	966067-2	500
18	0.75	2.5 [.098]	Normal	Grey	14.0 [.551]	8.0 [.315]	1.2 [.047]	2.8 [.110]	10.0 [.394]	966067-5	500
17	1.00	2.7 [.106]	Normal	Red	14.0 [.551]	8.0 [.315]	1.4 [.055]	3.0 [.118]	10.0 [.394]	966067-9	500
16	1.50	3.2 [.126]	Normal	Black	14.0 [.551]	8.0 [.315]	1.7 [.067]	3.5 [.138]	10.0 [.394]	1-966067-2	500
14	2.50	3.9 [.154]	Normal	Blue	14.0 [.551]	8.0 [.315]	2.2 [.087]	4.2 [.165]	10.0 [.394]	1-966067-6	500
11	4.00	4.5 [.177]	Normal	Grey	17.0 [.669]	10.0 [.394]	2.8 [.110]	4.8 [.189]	12.0 [.472]	1-966067-9	500
10	6.00	6.0 [.236]	Normal	Yellow	20.0 [.787]	12.0 [.472]	3.5 [.138]	6.3 [.248]	14.0 [.551]	2-966067-2	100
7	10.00	7.3 [.287]	Normal	Red	22.0 [.866]	12.0 [.472]	4.5 [.177]	7.6 [.299]	15.0 [.591]	2-966067-4	100

**Double Wire Ferrules
Tubing Form
with Plastic Sleeve,
According to DIN 46228,
Part 4**

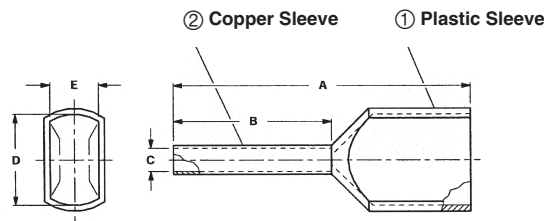

Wire Size Range AWG (mm ²)	Insulation Diameter Max	Version	Insulation Color	Dimensions					Strip Length	Part Number	Packaging Unit	
				A	B	C	D	E				
2 x 20	2 x 0.50	2.1 [.083]	Normal	White	15.0 [.591]	8.0 [.315]	1.40 [.055]	4.7 [.185]	2.5 [.098]	10.0 [.394]	966144-1	500
2 x 18	2 x 0.75	2.2 [.087]	Normal	Grey	15.0 [.591]	8.0 [.315]	1.70 [.067]	5.0 [.197]	2.8 [.110]	10.0 [.394]	966144-2	500
2 x 18	2 x 0.75	2.2 [.087]	Long	Grey	17.0 [.669]	10.0 [.394]	1.70 [.067]	5.0 [.197]	2.8 [.110]	12.0 [.472]	966144-3	500
2 x 17	2 x 1.00	2.5 [.098]	Normal	Red	15.0 [.591]	8.0 [.315]	1.95 [.077]	5.4 [.213]	3.4 [.134]	10.0 [.394]	966144-4	500
2 x 16	2 x 1.50	3.0 [.118]	Normal	Black	16.0 [.630]	8.0 [.315]	2.20 [.087]	6.6 [.260]	3.6 [.142]	10.0 [.394]	966144-6	500
2 x 14	2 x 2.50	3.6 [.142]	Normal	Blue	18.5 [.728]	10.0 [.394]	2.80 [.110]	7.8 [.307]	4.2 [.165]	12.0 [.472]	966144-8	250
2 x 11	2 x 4.00	4.1 [.161]	Normal	Grey	23.0 [.906]	12.0 [.472]	3.70 [.146]	8.8 [.346]	4.9 [.193]	14.0 [.551]	1-966144-0	100

Note: All part numbers are RoHS Compliant.

Accessories (Continued)

DIN Tubular End Sleeve with Plastic Sleeve

According to DIN 46228, Part 4, in Strip Form

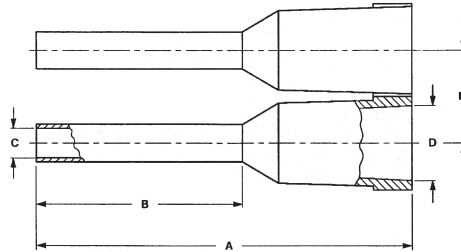

Wire Size Range		Insulation Diameter Max.	Insulation Color	Dimensions					Strip Length	Part Number	Packaging Unit
AWG	(mm ²)			A	B	C	D	E			
20	0.50	2.4 [.094]	White	14.5 [.571]	8.0 [.315]	1.1 [.043]	2.8 [.110]	3.5 [.138]	10.0 [.394]	1241000-1	1,000
18	0.75	2.6 [.102]	Grey	14.5 [.571]	8.0 [.315]	1.3 [.051]	2.9 [.114]	3.5 [.138]	10.0 [.394]	1241001-1	1,000
17	1.00	2.9 [.114]	Red	14.5 [.571]	8.0 [.315]	1.5 [.059]	3.2 [.126]	3.9 [.154]	10.0 [.394]	1241002-1	1,000
16	1.50	3.2 [.126]	Black	14.5 [.571]	8.0 [.315]	1.8 [.071]	3.4 [.134]	4.1 [.161]	10.0 [.394]	1241003-1	1,000
14	2.50	4.0 [.157]	Blue	14.5 [.571]	8.0 [.315]	2.3 [.091]	4.3 [.169]	5.0 [.197]	10.0 [.394]	1241004-1	500
14	2.50	4.0 [.157]	Grey	14.5 [.571]	8.0 [.315]	2.3 [.091]	4.3 [.169]	5.0 [.197]	10.0 [.394]	1241004-2	500

Product Facts

- Self-adjusting rectangular crimp profile for DIN-style crimp
- Only two hand tools are needed to crimp wire sizes from 0.14 mm² through 10.0 mm²
- Adjustable crimp pressure
- Crimp control

Application Tooling

Crimp Hand Tool for Wire Ferrules

This newly designed self-adjusting die set offers a time-saving crimping process and uniform crimp. A ratchet system provides for a complete crimp cycle before releasing. The crimp is according to DIN specification.

The tool handles are contoured for comfort.

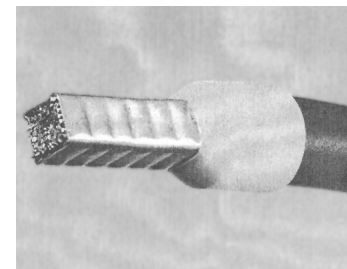
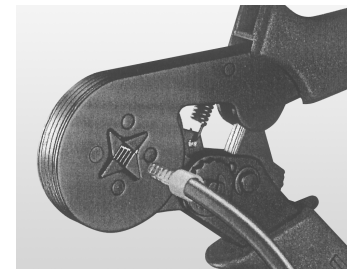
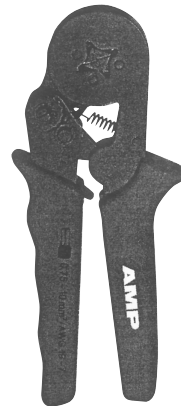

Loose Piece Tooling

Wire Size Range (mm ²)	Part Number
0.14-6.00	539660-1
0.75-10.0	539661-1

Strip Form Tooling

End Sleeve Part Number	Applicator Part No.		
	CLS IV+ Lead Maker	K Terminator	G Terminator
1241000-1	—*	—*	—*
1241001-1	—*	—*	—*
1241002-2	—*	—*	—*
1241003-1	—*	—*	—*
1241004-1	—*	—*	—*
1241004-2	—*	—*	—*

*Contact the Tooling Assistance Center for Part Number