

**B**  
TSS Series

**Slide Switches, Vertical, Single or Dual Actuator**

**MATERIAL SPECIFICATIONS:**

Contacts .....Copper w/gold plate over nickel  
 Case Material .....High temperature polyester (94-VO)  
 Actuator Material .....Polyester (94-VO)  
 Terminals .....Copper alloy tin/lead/nickel or gold/nickel  
 Terminal Seal .....Epoxy standard: single pole, optional: double pole

**TYPICAL PERFORMANCE CHARACTERISTICS:**

Contact Rating .....Gold: 0.4 VA max. @ 20 VDC or peak AC  
 Initial Contact Resistance .....20 Milliohms max.  
 Contact Timing .....Non-shorting  
 Insulation Resistance .....1,000 Megohms min. @ 500 VDC  
 Dielectric Strength .....1,000 Volts RMS @ sea level  
 Plunger/Actuator Travel .....0.120" (3.05)  
 Life Expectancy .....Up to 60,000-80,000 Cycles

**ENVIRONMENTAL SPECIFICATIONS:**

Operating Temperature .....-4°F to + 176°F (-20°C to + 80°C)  
 Storage Temperature .....-4°F to + 176°F (-20°C to + 80°C)

**SPST/SPDT**

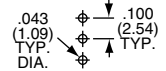
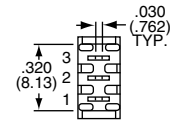
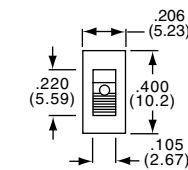
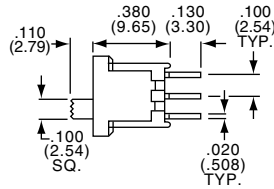

**SPST/SPDT (DUAL)**

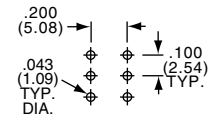
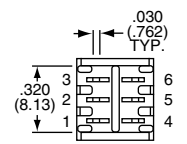
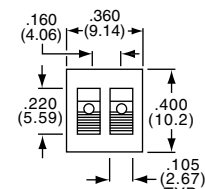
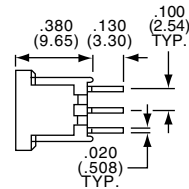

Extended Actuator Tyco Electronics	Alcoswitch	Type	Act. Code P. M6	On	None	Off	Extended Dual Actuator Tyco Electronics	Alcoswitch	Type	Act. Code P. M6	On	None	Off
1437578-3	TSS11AGPC	SPST	A	On	None	Off	—	TSD21AAGPC	2 x SPST	A	On	None	Off
1-1437589-0	TSS11DGPC	SPDT	D	On	None	On	1437579-5	TSD21DDGPC	2 x SPDT	D	On	None	On
1-1437579-4	TSS11EGPC	SPDT	E	On	Off	On	<b>Flush Dual Actuator</b>						
—	TSS11AG1PC	SPST	A	On	None	Off	—	TSD21DDG1PC	2 x SPDT	D	On	None	On
1437579-8	TSS11DG1PC	SPDT	D	On	None	On							
1-1437579-2	TSS11EG1PC	SPDT	E	On	Off	On							

Note: No center terminals on "A" action switches.

**DPST/DPDT**

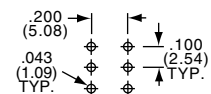
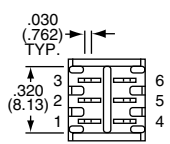
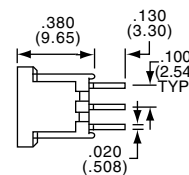
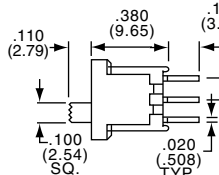
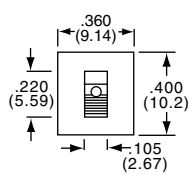

Extended Actuator Tyco Electronics	Alcoswitch	Type	Act. Code P. M6	On	None	Off	Flush Actuator Tyco Electronics	Alcoswitch	Act. Code Type	P. M6	On	None	Off
1-1437579-6	TSS21KGPC	DPST	K	On	None	Off	—	TSS21KG1PC	DPST	K	On	None	Off
1-1437579-9	TSS21NGPC	DPDT	N	On	None	On	1-1437579-7	TSS21NG1PC	DPDT	N	On	None	On
2-1437579-3	TSS21PGPC	DPDT	P	On	Off	On	2-1437579-1	TSD21RG1PC	DPDT	P	On	Off	On

Note: No center terminals on "K" action switches.

**4PDT**

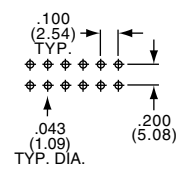
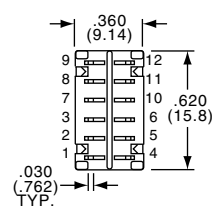
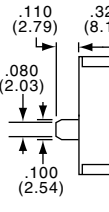
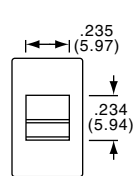

Extended Actuator Tyco Electronics	Alcoswitch	Type	Act. Code P. M6	On	None	Off
2-1437579-5	TSS41NGPC	4PDT	N	On	None	On

**Slide Switches, Right Angle, Single or Dual Actuator**

SEE PAGE B18 FOR PRODUCT SPECIFICATIONS

SPDT



Extended Actuator				Act. Code			Flush Actuator				Act. Code		
Tyco Electronics	Alcoswitch	Type	P. M6	On	None	Off	Tyco Electronics	Alcoswitch	Type	P. M6	On	None	Off
1-1437579-1	TSS11DGRA	SPDT	D	On	None	On	1437579-9	TSS11DG1RA	SPDT	D	On	None	On
1-1437579-5	TSS11EGRA	SPDT	E	On	Off	On	1-1437579-3	TSS11EG1RA	SPDT	E	On	Off	On

SPDT (DUAL)

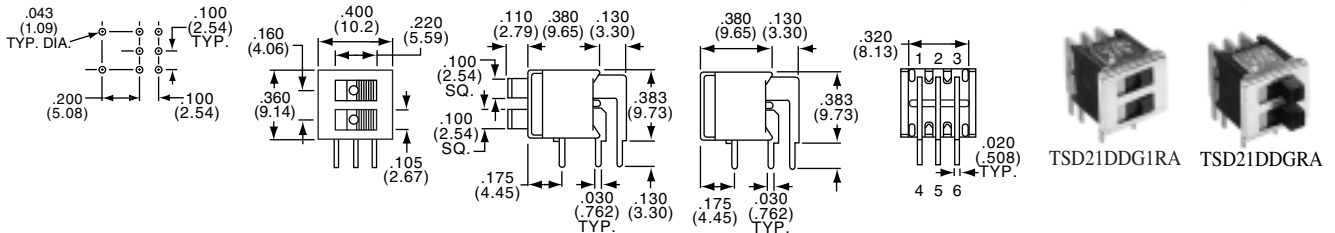

Extended Actuator				Act. Code			Flush Actuator				Act. Code		
Tyco Electronics	Alcoswitch	Type	P. M6	On	None	Off	Tyco Electronics	Alcoswitch	Type	P. M6	On	None	Off
1437579-6	TSD21DDGRA	2 x SPDT	D	On	None	On	1437579-4	TSD21DDG1RA	2 x SPDT	D	On	None	On
1437579-7	TSD21EEGRA	2 x SPDT	E	On	Off	On	—	TSD21EEG1RA	2 x SPDT	E	On	Off	On

DPDT

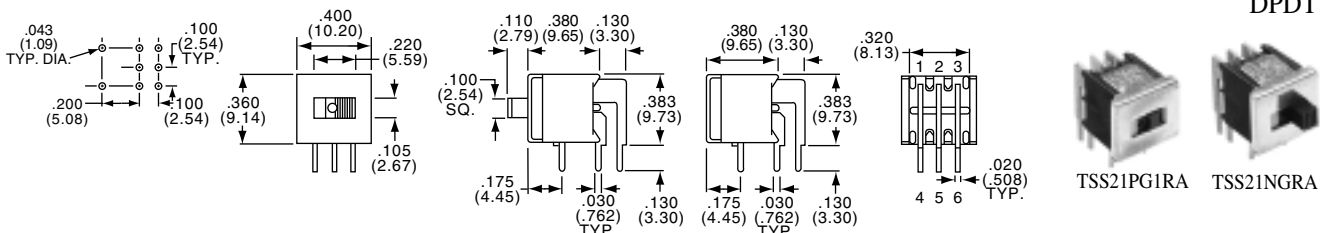

Extended Actuator				Act. Code			Flush Actuator				Act. Code		
Tyco Electronics	Alcoswitch	Type	P. M6	On	None	Off	Tyco Electronics	Alcoswitch	Type	P. M6	On	None	Off
—	TSS21PAGRA	SP3T	PA	On	On	On	—	TSS21NG1RA	DPDT	N	On	None	On
2-1437579-0	TSS21NGRA	DPDT	N	On	None	On	—	TSS21PG1RA	DPDT	P	On	Off	On
2-1437579-4	TSS21PGRA	DPDT	P	On	Off	On							

4PDT

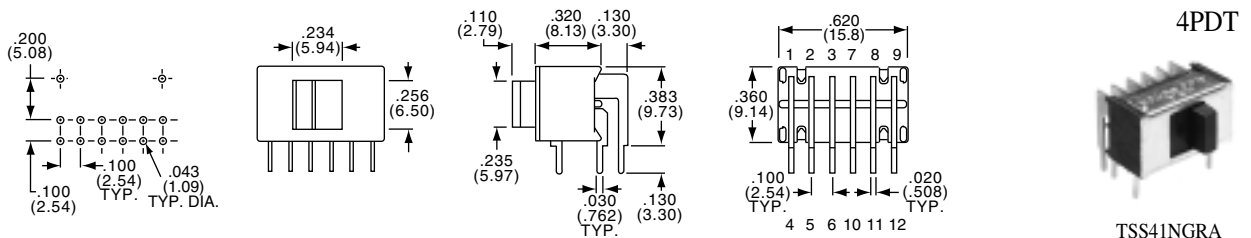

Extended Actuator		Act. Code				
Tyco Electronics	Alcoswitch	Type	P. M6	On	None	Off
2-1437579-7	TSS41NGRA	4PDT	N	On	None	On

**Slide Switches, Instrumentation Grade**

**MATERIAL SPECIFICATIONS:**

Contacts .....Gold or silver over nickel/copper alloy  
 Frame Material .....Tin plated steel  
 Terminals/Fixed Contacts.....Gold or silver over nickel/over copper alloy  
 Terminal Seal .....Epoxy  
 Actuator Material .....POM-UL94HB

**ENVIRONMENTAL SPECIFICATIONS:**

Operating Temperature.....-4°F to +185°F (-20°C to +85°C)  
 Storage Temperature.....-40°F to +212°F (-40°C to +100°C)  
 Solder Heat Resistance .....See page M3-4

**TYPICAL PERFORMANCE CHARACTERISTICS:**

Contact Rating .....Gold: 0.4 VA 20 VDC or peak AC  
 Silver: 300 mA @ 125 VAC  
 Initial Contact Resistance .....20 Milliohms max.  
 Contact Timing .....Make before break  
 Insulation Resistance .....1,000 Megohms min.  
 Dielectric Strength .....500 VAC  
 Actuation Force .....100 to 600 Grams  
 Life Expectancy .....Up to 15,000 Cycles  
 Travel .....0.079" (2.01) (unless otherwise specified)

**B**  
MSS Series

**SPDT**



MSS1200

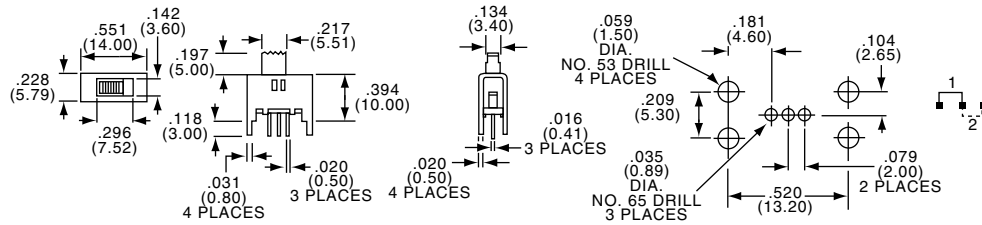

MSS1200R

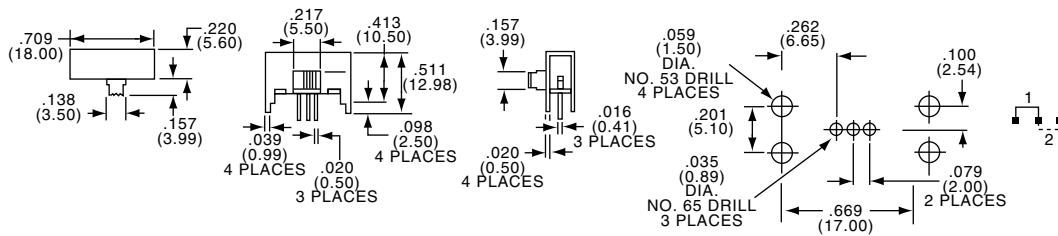

Tyco Electronics	Alcoswitch	Plating	Tyco Electronics	Alcoswitch	Plating
5-1437576-0	MSS1200	Silver	5-1437576-2	MSS1200R	Silver
5-1437576-1	MSS1200G	Gold	5-1437576-3	MSS1200RG	Gold

**SP3T**



MSS1300

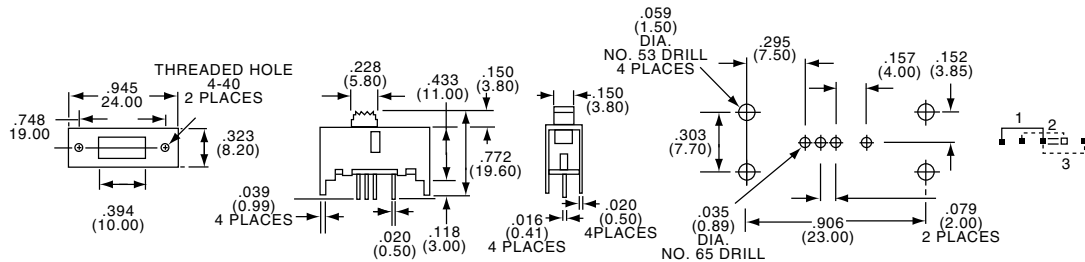

MSS1300R

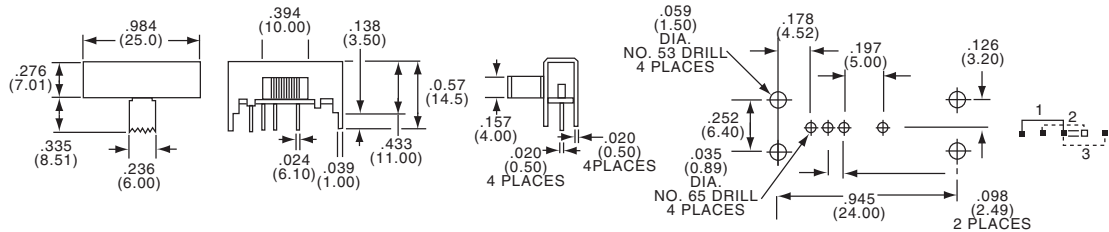

Tyco Electronics	Alcoswitch	Plating	Tyco Electronics	Alcoswitch	Plating	Total Actuator Travel
5-1437576-4	MSS1300	Silver	5-1437576-6	MSS1300R	Silver	.098(2.50)
5-1437576-5	MSS1300G	Gold	5-1437576-7	MSS1300RG	Gold	.098(2.50)

**Slide Switches, Instrumentation Grade**

SEE PAGE B20 FOR PRODUCT SPECIFICATIONS

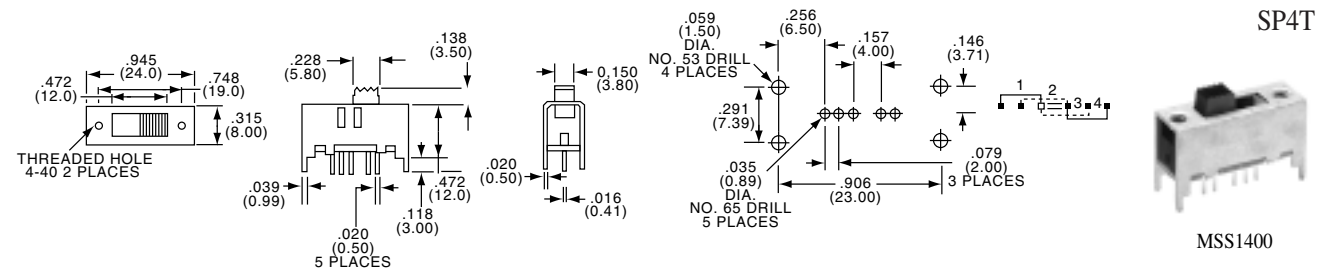

Tyco Electronics	Alcoswitch	Plating
5-1437576-8	MSS1400	Silver
1571423-1	MSS1400G	Gold

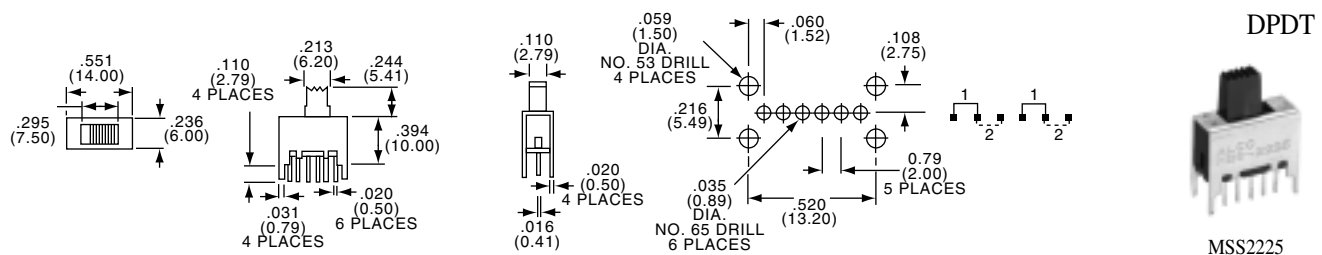

Tyco Electronics	Alcoswitch	Plating
6-1437576-3	MSS2225	Silver
6-1437576-4	MSS2225G	Gold

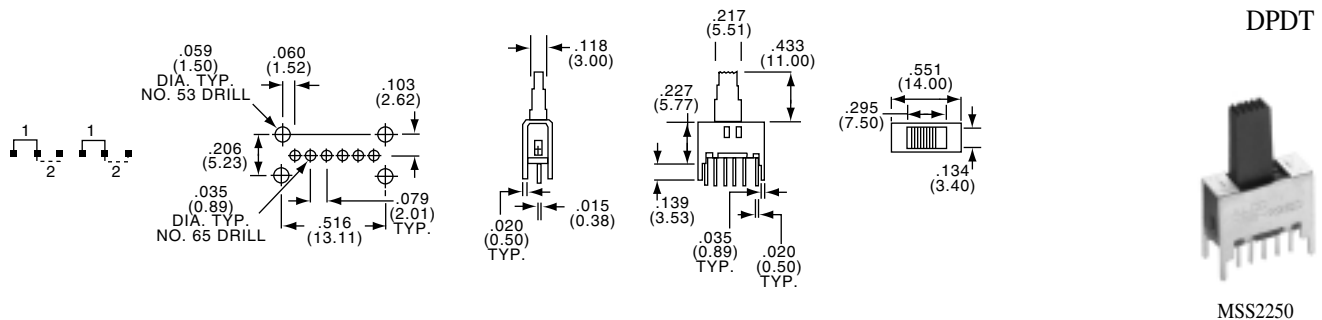

Tyco Electronics	Alcoswitch	Plating
6-1437576-5	MSS2250	Silver
6-1437576-6	MSS2250G	Gold

**Slide Switches, Instrumentation Grade**

SEE PAGE B20 FOR PRODUCT SPECIFICATIONS

DPDT



MSS2250R

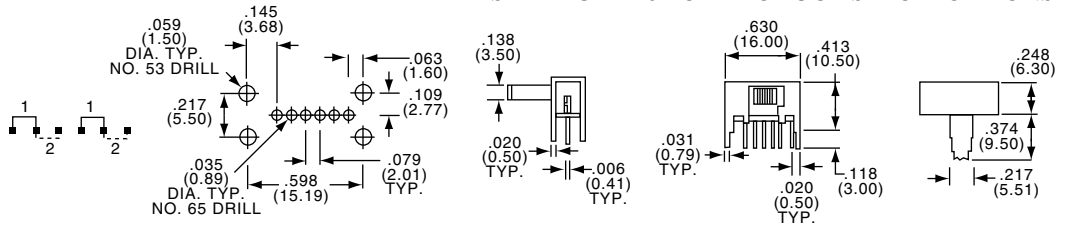

Tyco Electronics	Alcoswitch	Plating
6-1437576-7	MSS2250R	Silver
6-1437576-8	MSS2250RG	Gold

4PDT



MSS4200

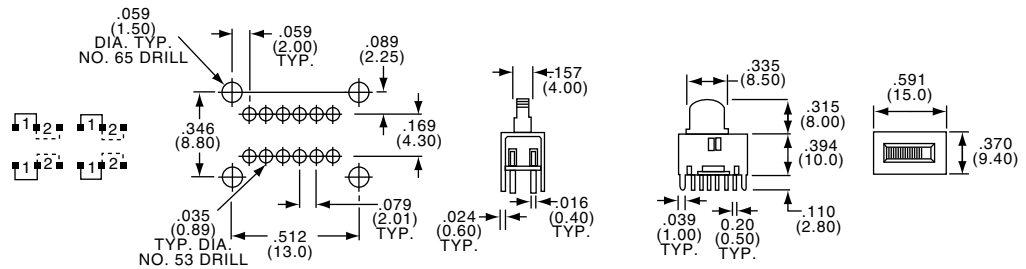

Tyco Electronics	Alcoswitch	Plating
6-1437576-9	MSS4200	Silver
7-1437576-0	MSS4200G	Gold

4PDT



MSS4250

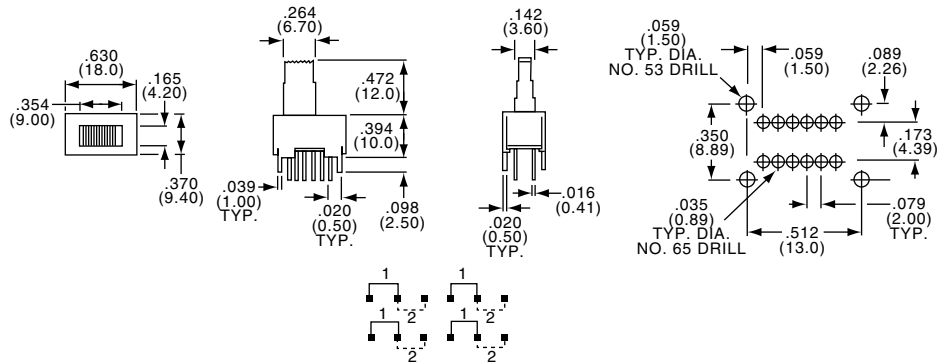

Tyco Electronics	Alcoswitch	Plating
7-1437576-4	MSS4250	Silver

**Slide Switches, Instrumentation Grade**

SEE PAGE B20 FOR PRODUCT SPECIFICATIONS

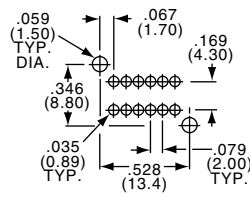
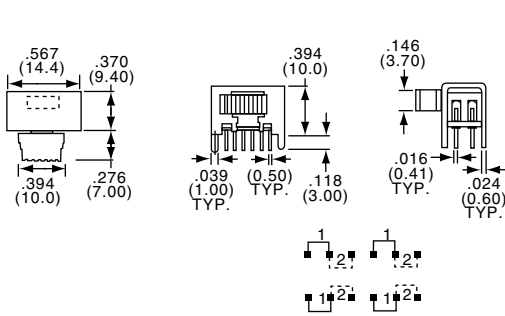

4PDT



MSS4200R

Tyco Electronics	Alcoswitch	Plating
7-1437576-2	MSS4200R	Silver
7-1437576-3	MSS4200RG	Gold

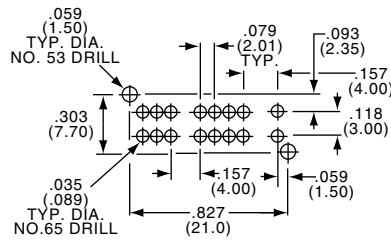
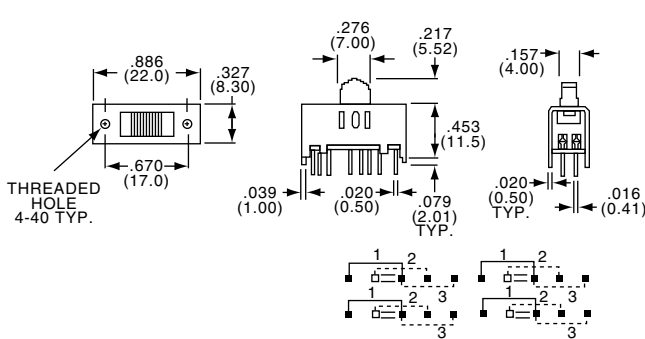

4P3T



MSS4300

Tyco Electronics	Alcoswitch	Plating
7-1437576-5	MSS4300	Silver
7-1437576-6	MSS4300G	Gold

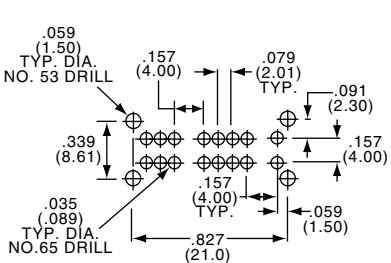
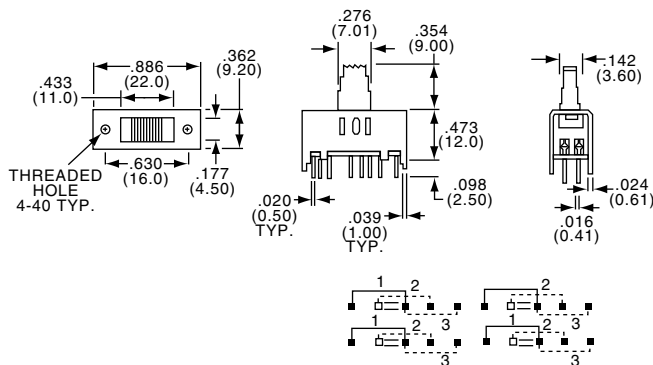

4P3T



MSS4335

Tyco Electronics	Alcoswitch	Plating
7-1437576-9	MSS4335	Silver