

**Note:** All part numbers are RoHS Compliant.

**Table of Contents—NEMA ETB**





Overview (Selector Chart) .....240-243  
 Catalog Numbering Code .....244  
 Miniature Blocks, 100 Series .....245-248  
 Medium Duty, 900 Series/ERT Series (Radiation Resistant) .....249-257  
 Heavy Duty, 200 Series .....259-266  
 Heavy Duty, Phenolic, 200 Series .....267-272  
 Intermediate Heavy Duty, 800 Series .....273-276  
 Ultra Heavy Duty, 400 Series .....277-279  
 Fuse & Switch .....281-288  
 One-Piece Phenolic Blocks .....289-292  
 Accessories .....293  
 Technical Summary .....294-295  
 UL 1059 Basic Voltage Rating .....296

## NEMA ETB Selector Chart

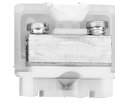
### High Density Series 100

### Medium Duty Series 900



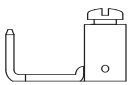







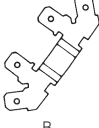
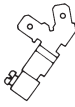

	High Density Miniature	High Density Single Tier	High Density Double Tier	Medium Duty			
<b>Mounting</b>	Direct Mount, Miniature Channel	Direct Mount, Standard & Breakaway Channel	Channel only: Standard & Breakaway	Direct Mount Standard, Miniature & Breakaway Channels			
<b>AWG Wire Range</b>	#30-12	#30-12	#30-12	#22-8	#22-8	10*, #22-14	#22-10
<b>Contact Types</b>		Tubular Clamp		Tubular Clamp	Tubular Screw	Strap Screw	Plug-In
<b>R</b> =Shipped with screws raised <b>B</b> =Shipped with screws bottomed		 B		 B	 B	 B	
<b>Ampacity</b>	28A	28A	25A	30A	50A	35A*, 15A	30A
<b>Voltage</b>	300 V 600 V (Limited Power Circuits)	600 V	600 V	600 V	600 V	600 V	600 V
<b>Center-to-Center Spacing</b>	.25" [6.35]	.25" [6.35]	.24" [6.10]	.375" [9.53]	.375" [9.53]	.375" [9.53]	.375" [9.53]
<b>Housing Material</b>	Nylon or Polypropylene	Nylon	Nylon	PCT	PCT	PCT	PCT
<b>Flammability Rating</b>	UL94V-2 or UL94V-0	UL94V-2	UL94V-2	UL94V-0	UL94V-0	UL94V-0	UL94V-0
<b>Max. Service Temperature</b>	125°C (257°F) or 105°C (222°F)	125°C (257°F)	125°C (257°F)	150°C (302°F)	150°C (302°F)	150°C (302°F)	150°C (302°F)
<b>Pages</b>		246		250	250	250	251

\*Acceptable for 35A max. factory wiring only when used with 10AWG wire preterminated with suitable ring tongue terminals.

**Note:** All part numbers are RoHS Compliant.











**NEMA ETB Selector Chart (Continued)**

	<b>Medium Duty Series 900</b>		<b>ERT Series</b>			<b>Heavy Duty Series 200</b>			
									
	<b>Medium Duty</b>		<b>Medium Duty Radiation Resistant</b>			<b>Nylon or Polypropylene</b>			
<b>Mounting</b>	Direct Mount Standard, Miniature & Breakaway Channels		Standard and Breakaway Channels			Direct Mount or: Flat Base fits Miniature Channel. Dovetail Base fits Standard & Breakaway Channels			
<b>AWG Wire Range</b>	— #18-12		#22-8	#22-8	#10*, #22-14	#18-6 smaller	#18-4	#18-8	#10 & smaller
<b>Contact Types</b>	Quick Connect	Tubular Quick Connect Combination	Tubular Clamp	Tubular Screw	Strap Screw	Tubular Clamp	Tubular Screw	Strap Clamp	Strap Screw
<b>R=</b> Shipped with screws raised <b>B=</b> Shipped with screws bottomed									
<b>Ampacity</b>	20A	20A	30A	50A	35A*, 15A	65A	85A	50A	35A
<b>Voltage</b>	300 V		600 V			600 V			
<b>Center-to-Center Spacing</b>	.375" [9.53]		.375" [9.53]			.50" [12.70]			
<b>Housing Material</b>	PCT		RYTON			Nylon or Polypropylene			
<b>Flammability Rating</b>	UL94V-0		UL94V-0			UL94V-2 or UL94V-0			
<b>Max. Service Temperature</b>	150°C (302°F)		200°C (392°F)			125°C (257°F) or 105°C (222°F)			
<b>Pages</b>	250	251	252			260-261			



**Note:** All part numbers are RoHS Compliant.

**NEMA ETB Selector Chart** (Continued)

	Heavy Duty Series 200				Intermediate HD Series 800		Ultra Heavy Duty Series 400	
								
	Phenolic				Intermediate Heavy Duty		Ultra Heavy Duty	
<b>Mounting</b>	Direct Mount or Standard & Breakaway Channels				Direct Mount or Standard & Breakaway Channels		Direct Mount or Standard & Breakaway Channels	
<b>AWG Wire Range</b>	#18-6	#18-4	#18-8	#10 & smaller	#12-1/0		#12-2/0 kcmil (MCM)	
<b>Contact Types</b>	Tubular Clamp	Tubular Screw	Strap Clamp	Strap Screw	Tubular Screw		Tubular Screw	Tubular Screw
<b>R</b> =Shipped with screws raised <b>B</b> =Shipped with screws bottomed	 B	 R	 B	 B	 B		 R	 R
<b>Ampacity</b>	65A	85A	50A	35A	150A		175A	255A
<b>Voltage</b>	600 V				600 V		600 V	
<b>Center-to-Center Spacing</b>	.56" [14.22]				.75" [19.05]		1.19" [30.23]	
<b>Housing Material</b>	Phenolic				Nylon		Phenolic	
<b>Flammability Rating</b>	UL94V-1				UL94V-2		UL94V-1	
<b>Max. Service Temperature</b>	150°C (302°F)				125°C (257°F)		150°C (302°F)	
<b>Pages</b>	267-272				273-276		277-279	









**Note:** All part numbers are RoHS Compliant.

**NEMA ETB Selector Chart (Continued)**

**Fuse and Switch Series 300**

**One-Piece**



	Nylon or Polypropylene			Phenolic			One-Piece		
<b>Mounting</b>	Direct Mount or Standard & Breakaway Channels			Direct Mount or Standard & Breakaway Channels			Direct Mount		
<b>AWG Wire Range</b>	#18-8	#18-8	#8	#18-8 & Smaller	#18-8	#8 & Smaller	#6	#8	#8
<b>Contact Types</b>	Tubular Screw	Strap Clamp	Strap Screw	Tubular Screw	Strap Clamp	Strap Screw	Tubular Clamp	Strap Clamp	Strap Screw
<b>R</b> =Shipped with screws raised <b>B</b> =Shipped with screws bottomed	 B	 B	 B	 B	 B	 B	 B	 B	 B
<b>Ampacity</b>	15A Switch 30A Fuse			15A Switch 30A Fuse			70A	50A	50A
<b>Voltage</b>	600 V			600 V			600 V		
<b>Center-to-Center Spacing</b>	.75" [19.05]			.75" [19.05]			.63" [16.00]		
<b>Housing Material</b>	Nylon or Polypropylene			Phenolic			Phenolic		
<b>Flammability Rating</b>	UL94V-2 or UL94V-0			UL94V-1			UL94V-1		
<b>Max. Service Temperature</b>	125°C (257°F) or 105°C (222°F)			150°C (302°F)			150°C (302°F)		
<b>Pages</b>	282-285			286-288			289-292		

**Note:** All part numbers are RoHS Compliant.

**Catalog Numbering Code**

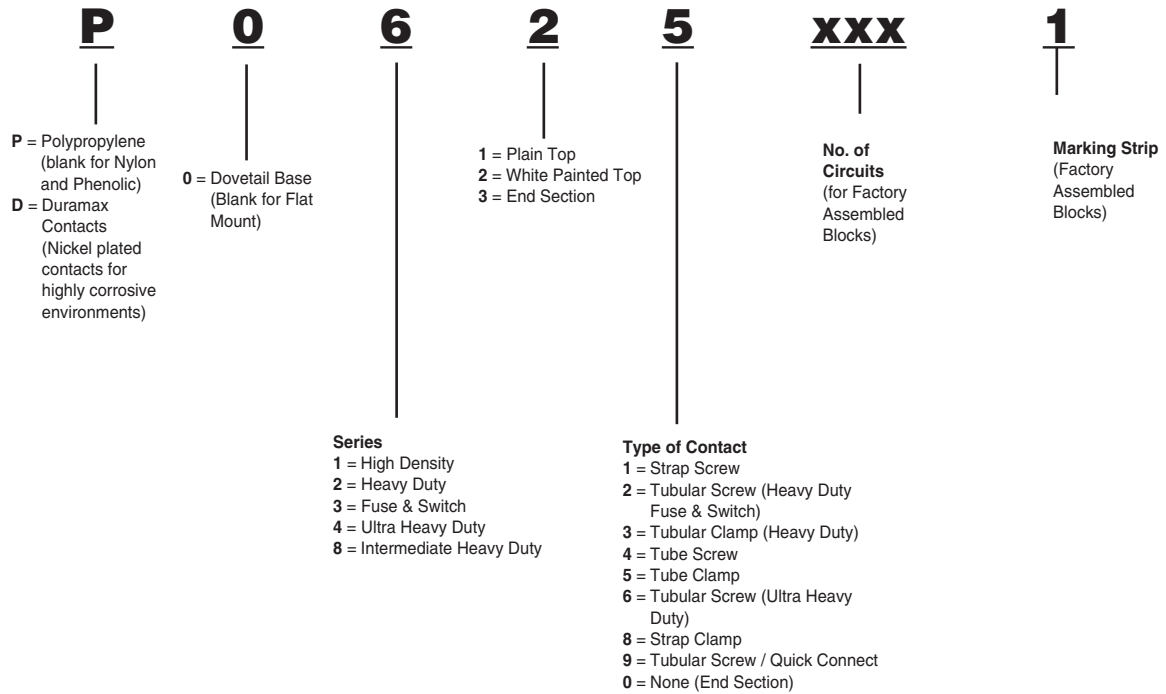

**Note:** Some catalog number combinations are not valid. Check appropriate catalog pages before ordering.

## 100 Series High Density Miniature Blocks

### Product Facts

- n **No Wire Crimping Required** — tubular clamp contacts hold wire ranging from #30 to #12 AWG better than crimp-on terminals.
  - n **Saves Installation Time and Costs** — tubular clamp contacts are supplied with captive screws backed out.
  - n **Nylon housing standard; polypropylene for fire retardant characteristics.**
  - n **Positive Stop** — helps prevent wire from being inserted too far, and helps prevent screw from being tightened on insulation. Easy access contact provides for safe, reliable, and cost-effective connection.
  - n **Quick Installation and Change** — additional sections may be added or removed without removing channel mounting screw.
  - n **Choice of Five Mounting Channels:**
    - n Miniature aluminum
    - n Zinc-plated steel
    - n Pre-punched aluminum
    - n Break-away steel
  - n **Single and Double Tier blocks fit all standard BUCHANAN mounting channels. Single Tier blocks fit both miniature and standard channels.**
  - n **Choice of Marking Surfaces** — matte-finish area for marking directly on block; slide-in vinyl strip (blank or preprinted) also available.

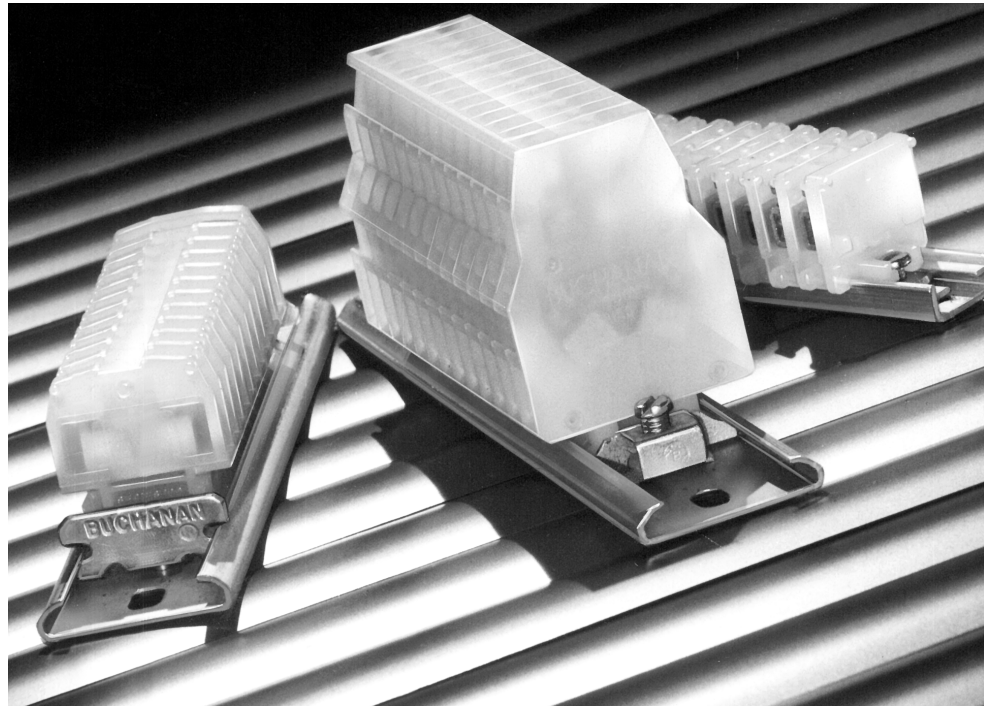

These miniature terminal blocks fit on a much smaller channel to save valuable panel space or can be surface mounted directly to the panel. Miniature blocks accept wire as large as #12 AWG and are available in four styles: Miniature (nylon), Miniature (polypropylene), Single Tier and Double Tier.

## 100 Series High Density Miniature Blocks



**Miniature  
Nylon**



**Miniature  
Polypropylene**



**Single Tier**

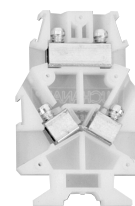

**Double Tier**

**Characteristics**

Type of Block	Model	Part Number	Model	Part Number	Model	Part Number	Model	Part Number
Standard Block	125-BU	2-1437392-3	P125	4-1437392-7	115-BU	1437381-5	105-BU	1-1437392-7
Corrosion Resistant (nickel plated contacts)	D125	3-1437389-3	DP125	7-1437389-1	D115	3-1437389-2	D105	2-1437392-9
<b>Specifications</b>								
Housing Material	Nylon	—	Polypropylene	—	Nylon	—	Nylon	—
Max. Service Temperature	125°C (257°F)	—	105°C (221°F)	—	125°C (257°F)	—	125°C (257°F)	—
Flammability	UL94V-2	—	UL94V-0	—	UL94V-2	—	UL94V-2	—
Wire Strip Length (in.)	5/16	—	5/16	—	5/16	—	5/16	—
Torque, in-lbs.	6-9	—	6-9	—	6-9	—	6-9	—
<b>Electrical Characteristics</b>								
UL Rating	20 A @ 300V	—	20 A @ 300V	—	20 A @ 600V	—	20 A @ 600V	—
Wire Range (solid & stranded)	30-12	—	30-12	—	30-12	—	30-12	—
<b>Spacing</b>								
Pitch	0.25"	—	0.25"	—	0.25"	—	0.24"	—
Terminals per Foot	48	—	48	—	48	—	102	—
<b>Accessories</b>								
End Section (gray)	130-BU	2-1437392-5	P130	4-1437392-9	120	2-1437392-1	110-BU	1-1437392-8
Jumper, 2 pole	10	1437381-1	10	1437381-1	10	1437381-1	—	—
Jumper, 10 pole	—	—	—	—	—	—	J10	3-1437392-1
Jumper, Inter-tier	—	—	—	—	—	—	J2-BU	3-1437392-2
<b>Mounting Channel</b>								
Miniature (3ft)	12	1437381-8	12	1437381-8	12	1437381-8	—	—
Steel, Zinc plated (6ft)	—	—	—	—	60	9-1437381-1	60	9-1437381-1
Steel, Zinc plated (3ft)	—	—	—	—	63-BU	9-1437381-8	63-BU	9-1437381-8
Breakaway, steel	—	—	—	—	60B36	9-1437381-2	60B36	9-1437381-2
Pre-punched aluminum (6ft)	—	—	—	—	64	9-1437381-9	64	9-1437381-9
Pre-punched aluminum (3ft)	—	—	—	—	67	1437382-2	67	1437382-2
<b>Channel Clamps</b>								
Miniature (use w/#12 channel)	11	1437381-4	11	1437381-4	11	1437381-4	—	—
Universal	—	—	—	—	68	1437382-3	68	1437382-3



**Note:** All part numbers are RoHS Compliant.

**100 Series High Density Miniature Blocks Accessories**

**Channel Clamps**

**Marking Accessories**



Screw Steel Channel	Universal	Snap-in	Miniature for #12 Channel	See-thru Cover	Ganging Rod	Miniature Vinyl Marking Strips	Elevated Marking Strip	Nylon Holding Plug	
<b>Part Number</b>	9-1437381-5	1437382-3	9-1437381-7	1437381-4	1-1437381-0	1-1437381-1	1-1437381-2	4-1437381-1	1-1437381-3
<b>Catalog Number</b>	61	68	62	11	13	14	15	52-BU	16
<b>Available For</b>	Single Tier Double Tier	Single Tier Double Tier	Single Tier Double Tier	Miniature Single Tier	Miniature Single Tier	Miniature Single Tier	Miniature Single Tier Double Tier	Miniature Single Tier Double Tier	Miniature Single Tier
<b>Standard Length</b>	—	—	—	—	—	2 feet	25 feet	18 inches	—

**Factory Assembled Blocks**

Description	Direct Mount	Channel Mount
Miniature (nylon)	125xx	0125xx
	D125xx (nickel)	D0125xx (nickel)
Single Tier (nylon)	115xx	0115xx
	D115xx (nickel)	D0115xx (nickel)
Double Tier (nylon)	105xx	0105xx
	D105xx (nickel)	D0105xx (nickel)
Miniature (polypropylene)	P125xx	P0125xx
	DP125xx (nickel)	DP0125xx (nickel)

**Note:** xx = number of blocks desired. For factory assembled blocks with removable marking strip, add "-1" to Catalog Number. Minimum order quantities may apply.

**Related Product Data**

**Wire Pins and Ferrules**—Pages 109-111

For more information on AMP Standard Terminals and Splices or Quick-Connect FASTON Receptacles and Tabs, request Catalog 82042.



**Note:** All part numbers are RoHS Compliant.

**Miniature Blocks**

**Miniature**

$C = .29 [7.37] + (.25 [6.35] \times N)$   
 $L = .51 [12.95] + (.25 [6.35] \times N)$

**On Miniature Channel:**

$C_{CH} = 1.00 [25.4] + (.25 [6.35] \times A)$   
 $L_{CH} = 1.35 [34.29] + (.25 [6.35] \times A)$   
 A = N when N is even  
 A = N + 1 when N is Odd  
 N = No. of Miniature Sections

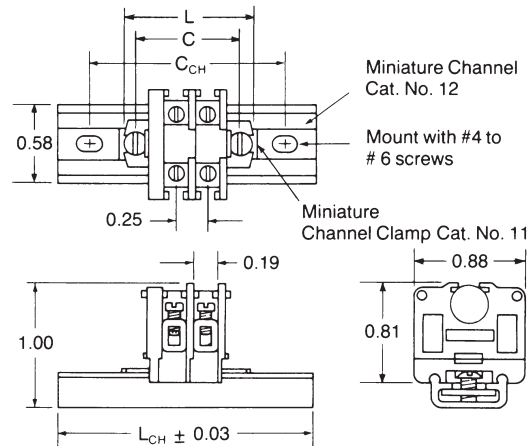

**Single Tier**

$C = .35 [8.89] + (.25 [6.35] \times N)$   
 $L = .50 [12.7] + (.25 [6.35] \times N)$

**On Standard Channel:**

$C_{CH} = 2.00 [50.8] + (.25 [6.35] \times N)$   
 $L_{CH} = 2.75 [69.85] + (.25 [6.35] \times N)$   
 N = No. of Single Tier Sections

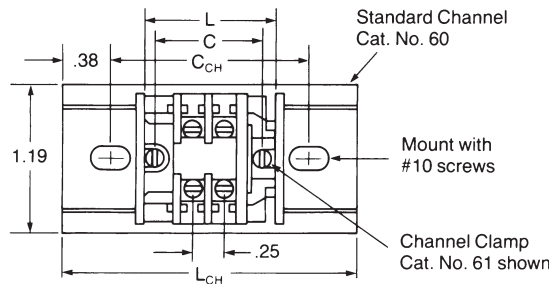

**On Miniature Channel:**

$C_{CH} = 1.00 [25.4] + (.25 [6.35] \times A)$   
 $L_{CH} = 1.35 [34.29] + (.25 [6.35] \times A)$   
 A = N when N is Even  
 A = N + 1 when N is Odd  
 N = No. of Single Tier Sections

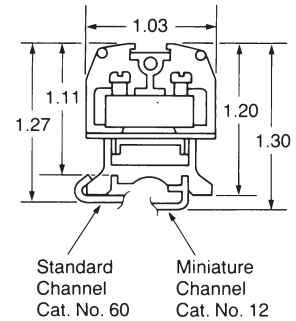
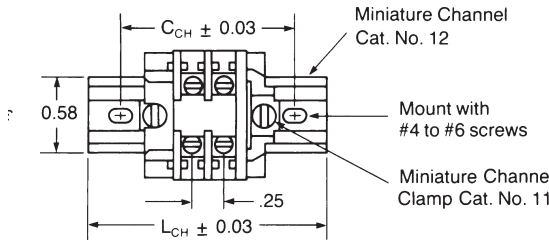

**Double Tier**

$L = .08 [2.03] + (.24 [6.10] \times N)$

**On Miniature Channel:**

$C_{CH} = 1.58 [2.03] + (.24 [6.10] \times A)$   
 $L_{CH} = 2.33 [59.18] + (.24 [6.10] \times A)$   
 N = No. of Double Tier Sections

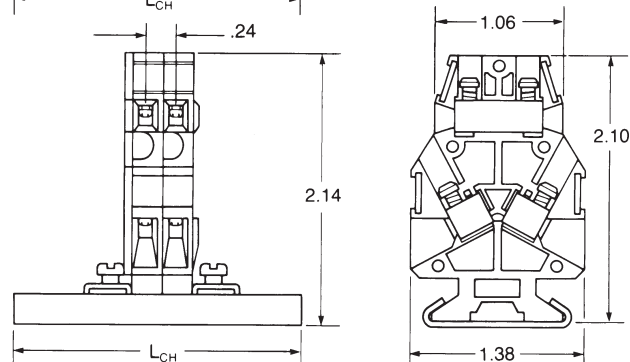
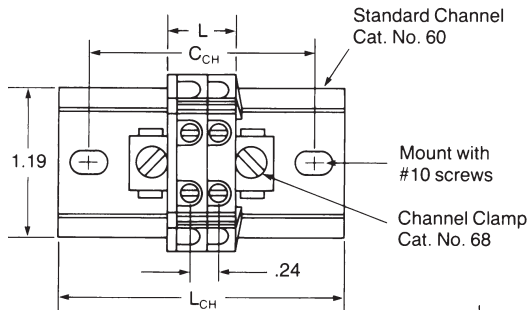

## 900 Series, Medium Duty

### Product Facts

- n High circuit density - 183 circuits per 6-foot length, 3/8 inch pitch.
- n Choice of five contact styles - tubular clamp, tubular screw, strap screw, quick connect and tubular screw quick connect.
- n Sections snap-fit with Heavy Duty, Intermediate Heavy Duty, and Fuse & Switch blocks.
- n Readily identify circuits - mark directly on block sections or use removable marking strip. Preprinted marking strips also available.
- n Rated up to 50 amperes per circuit.
- n Flat base models mount directly to surfaces or on miniature channel. Dovetail base mounts on standard size channel.
- n Packaged for rapid handling and assembly - 100 per carton.
- n Only one end section needed per block assembly.
- n Fanning strips - interlocking sectional fanning strips allow entire circuit groups to be connected and disconnected as a single unit.
- n Factory assembled blocks available, including marking strips and different contact sections.

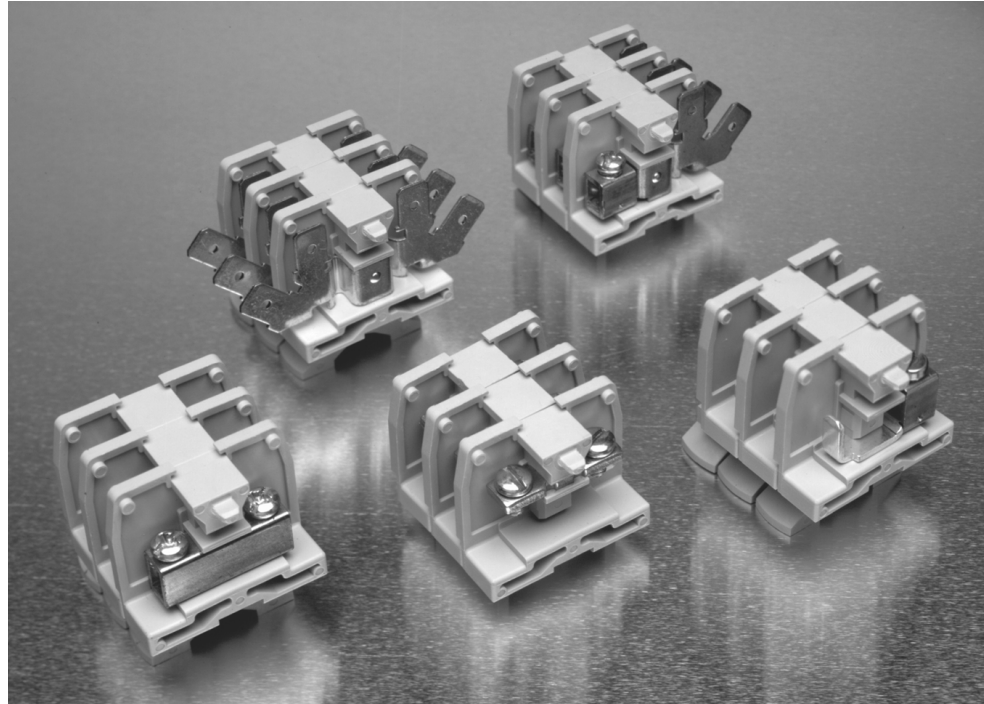

NEMA 900 Series is available in .375" [9.53] centerline, in direct or channel mount, tubular or strap versions, and screw, clamp or quick connect configurations. Corrosion-resistant versions are also available.

NEMA 900 Series snap fit with the Medium Duty 500, 600 and 700 Series, as well as with the Heavy Duty, Intermediate Heavy Duty and Fuse & Switch blocks.

**Note:** All part numbers are RoHS Compliant.

**900 Series, 600V Medium Duty, 0.375" [9.53] Pitch**

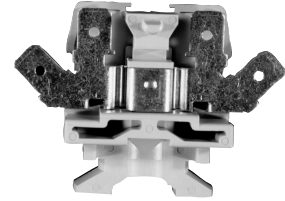
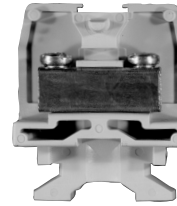
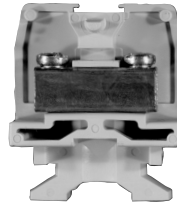

**Characteristics**

**Strap Screw**

**Tubular Screw**

**Tubular Clamp**

**Quick Connect**

Type of Block	Model	Part Number	Model	Part Number	Model	Part Number	Model	Part Number
<b>Direct Mount (Flat Base)</b>								
Standard	921	1546143-1	924	1546147-1	925	1546234-1	927	1546149-1
Corrosion Resistant (Duramax)	D921	1546143-2	D924	1546147-2	D925	1546234-2	—	—
<b>Channel Mount (Dovetail Base)</b>								
Standard	0921	1546144-1	0924	1546148-1	0925	1546235-1	0927	1546150-1
(Duramax)	D0921	1546144-2	D0924	1546148-2	D0925	1546235-2	—	—

**Contact Type**

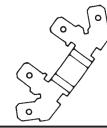

**Specifications**

Wire Range (AWG) Solid & Stranded	10*, 22-14	22-8	22-8	—
Wire Strip Length (in.)	—	11/32	11/32	—
Screw Type	6-32 Binding Head	10-32 Pan Head	10-32 Slotted Pan Head	—
Ampacity	35 A*, 15A	50 A	30 A	20 A

**End Sections**

Direct Mount	930	1546163-1	930	1546163-1	930	1546163-1	930	1546163-1
Channel Mount	0930	1546164-1	0930	1546164-1	0930	1546164-1	0930	1546164-1

\*Acceptable for 35A max. factory wiring only when used with 10AWG wire preterminated with suitable ring tongue terminals.  
**Note:** Standard package is 100 pieces for contact, 25 pieces for end section.

**Comparison (Type of Block)**



**Direct Mount (Flat Base)**

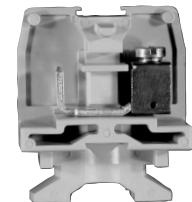

**Channel Mount (Dovetail Base)**



**Note:** All part numbers are RoHS Compliant.

**900 Series, 600V Medium Duty, 0.375" [9.53] Pitch** (Continued)

**Independent Testing Service Listing and Recognition**

WIRE SIZES, Solid or Stranded  
 Tubular Screw  
 1 #18 AWG to 1 #8 AWG,  
 2 or 3 #12 AWG, 2 to 4 #14 AWG,  
 2 or 4 #16 AWG, 2 to 5 #18 AWG,  
 Tubular Clamp  
 1 #22 AWG to 1 #10 AWG,  
 2 #12 AWG, 2 or 3 #14 AWG,  
 2 to 4 #16 AWG, 2 to 5 #18 AWG,  
 2 to 8 #20 AWG, 2 to 10 #22 AWG,  
 Strap Clamp  
 1 #22 AWG to 1 #10 AWG

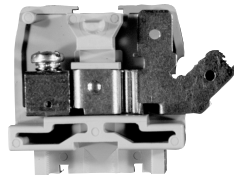

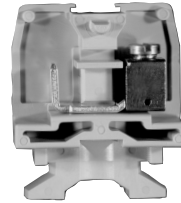

**Tubular Screw & Quick Connect**



**Tubular Clamp with Blade**

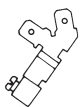
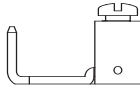

**Tubular Clamp with Cantilever**

Model	Part Number	Model	Part Number	Model	Part Number
929	1546151-1	—	—	—	—
0929	1546152-1	BP035M	3-1437394-6	BP35F	3-1437394-7
—	—	—	—	—	—
	18-12		22-10		22-10
—	—	—	11/32	—	11/32
—	—	—	10-32 Phil-slot	—	10-32 Phil-slot
20 A	—	30 A	—	30 A	—
930	1546163-1	—	—	—	—
0930	1546164-1	0930	1546164-1	—	—

NEMA Terminal Blocks

6



**Note:** All part numbers are RoHS Compliant.

**ERT Series, Medium Duty Radiation Resistant**

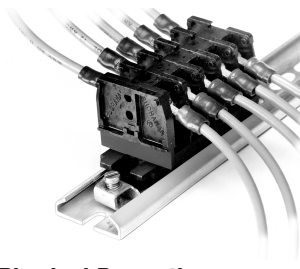

**Physical Properties**  
**Effect of Radiation on Physical Properties**

The effects of radiation (neutron and gamma particles) on RYTON R-4 material have been studied. Since RYTON, as an engineering plastic, may fill applications in nuclear installations these effects are important. The test results show no effects on physical properties by these relatively high exposures to gamma and neutron radiation. There is no indication from these data of crosslinking or degradation of the RYTON R-4 material.

**Note:** Determination of the suitability of the ERT Series Blocks for particular applications rests solely with customers.

DOVETAIL BASE MOUNTED ON STANDARD #60 CHANNEL

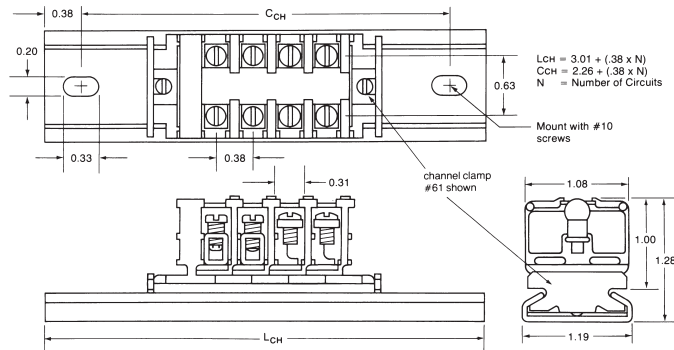

Description	Catalog Number	Part Number
Strap Screw	0721ERT	1437394-9
Tubular Clamp	0725ERT	1-1437394-6
Tubular Screw	0724ERT	1-1437394-1
End Section	0730ERT	2-1437394-0

Housing: RYTON (Polyphenylene Sulfide)		ASTM Test
Density	100 lbs./ft.3	D1505-68
Tensile Strength	19,500 psi	D638-72
Elongation	1.3%	D638-72
Flexural Modulus	1,700,000 psi	D790-91
Flexural Strength	29,000 psi	D790-91
Compressive Strength	21,000 psi	D695-69
Izod Impact Strength		
Unnotched, 1/8" Specimen	8.0 ft. lbs./in.	
Notched, 1/8" Specimen	1.4 ft. lbs./in.	
Rockwell Hardness	R-123	D785-65
Water Absorption	0.05%	D570-63
Heat Distortion Temp. @ 264 psi	500°F	D648-72
Specific Heat, 24 hrs. @ 25°C	0.25 btu/lb./°F	
Thermal Conductivity	2.0 btu-in./h-ft.2 F	
Coefficient/Linear Thermal Exp.	2.5 x 10-5 in./in./° F	
Flammability, UL 94	V-0	
Dielectric Strength	350 volts/mil	D149-64
Dielectric Constant, 25°C 1 kHz	3.9	D150-70
1MHz	3.8	
Dissipation Factor, 25°C 1kHz	0.0010	D150-70
1MHz	0.0013	
<b>Conditions</b>		
Temperature	In Reactor Core 35°C	In Water Pool 30°C
Radiation	Mainly neutrons	Mainly gamma
Intensity	1010 ergs g-1 (C)	109 ergs g-1 (C)
Used Particle Detectors	Calorimeter and activation detectors	Ionization chamber
<b>Radiation Dose</b>		
	Flexural Strength psi	Modulus of Elasticity, psi
0	28,700	1,900,000
<b>A. Neutron</b>		
5 x 10 rad	29,000	1,910,000
1 x 10 rad	28,900	1,880,000
<b>B. Gamma</b>		
5 x 10 rad	29,700	1,810,000
1 x 10 rad	30,200	1,840,000
5 x 10 rad	28,500	1,820,000

RYTON is a registered trademark of Chevron Phillips Chemical Company.



## Medium Duty Accessories

### Mounting Channel

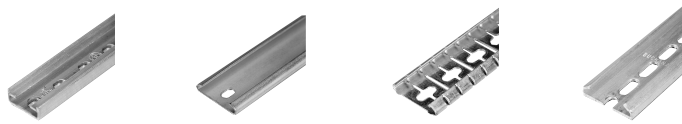

Miniature		Steel Channel		Break Away Steel		Pre-punched Aluminum Channel	
Part Number	Catalog Number	Part Number	Catalog Number	Part Number	Catalog Number	Part Number	Catalog Number
1437381-8	12	9-1437381-1 9-1437381-8	60 63-BU	9-1437381-2	60-B-36	9-1437381-9 1437382-2	64 67
<b>Standard Length</b>							
3 feet		6 feet 3 feet		3 feet		6 feet 3 feet	

### Channel Clamps



Screw Channel Clamps	Universal Clamps	Snap-In Clamps	Miniature for #12 Channel	See-thru Cover	Ganging Rod	Polarizing Plug
<b>Part Number</b>						
9-1437381-5	1437382-3	9-1437381-7	1437381-4	1-1437382-2	3-1437381-9	2-1437382-5
<b>Catalog Number</b>						
61	68	62	11	71	30-BU	84
<b>Standard Length</b>						
—	—	—	—	—	2 feet	—

### Jumpers



Jumper for tubular Contacts	Snap-apart for Tubular Contacts
<b>Part Number</b>	
1437382-6	1-1437382-3
<b>Catalog Number</b>	
70	73

### Related Product Data

**Wire Pins and Ferrules**—Pages 109-111  
For more information on AMP Standard Terminals and Splices or Quick-Connect FASTON Receptacles and Tabs, request Catalog 82042.

**Note:** All part numbers are RoHS Compliant.

**Medium Duty Accessories** (Continued)

**Marking Accessories**



Plastic Cloth Tape	Plastic Cloth Tape	Vinyl Marking Strips	Elevated Marking Strip	Nylon Holding Plug	
<b>Part Number</b>	1437382-1	8-1437381-0	6-1437381-3	4-1437391-1	4-1437393-0
<b>Catalog Number</b>	66	55-BU	50-BU	52-BU	65-BU
<b>Standard Length</b>	—	50 feet	25 feet	18 inches	—

**Sectional Fanning Strips**

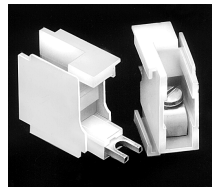

Strap Screw

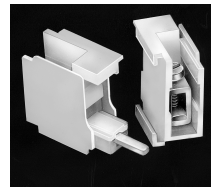

Tubular Screw

Description	Standard Package	Part No.	Catalog No.
Tubular Screw	50	1-1437382-4	74
Strap Screw	50	1-1437382-7	78-TB
Molding Only, no contact	50	4-1437393-1	74100



**Note:** All part numbers are RoHS Compliant.

**Medium Duty Channel Mount**

**Dovetail Base Mounted On Standard #60 Channel**

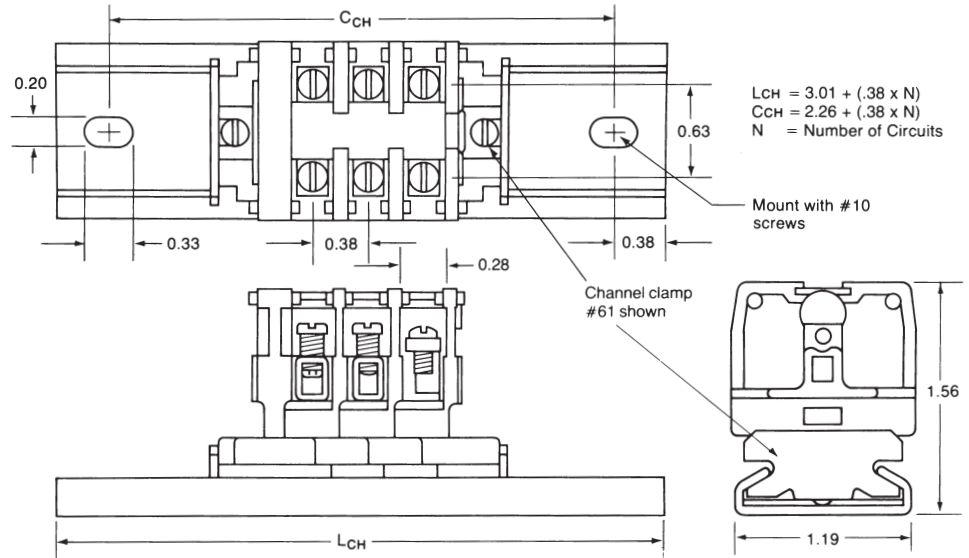

**Flat Base Mounted On Miniature #12 Channel**

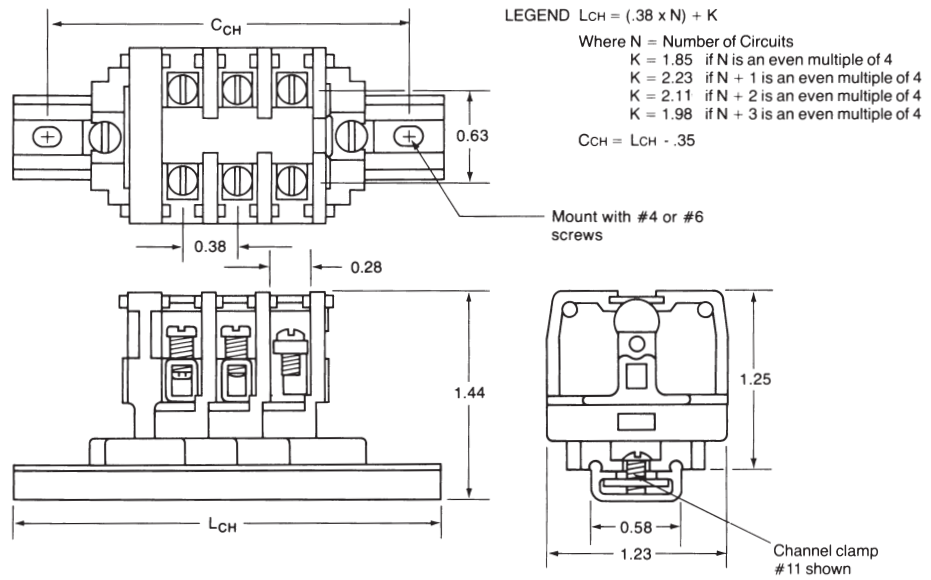

NEMA Terminal Blocks **6**

**Note:** All part numbers are RoHS Compliant.

**900 Series, Flat Base**

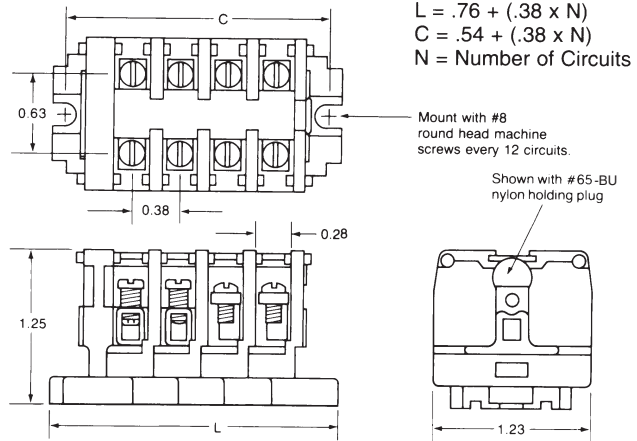
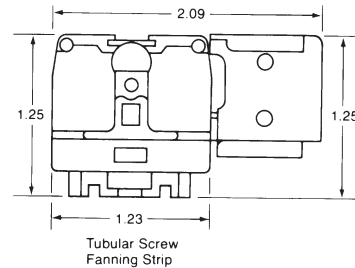
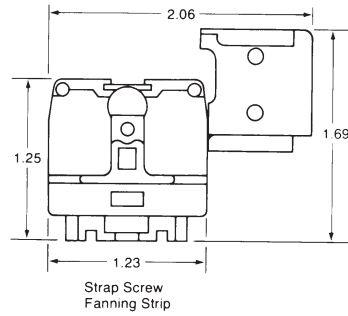

**Note:** All part numbers are RoHS Compliant.

**BP Series, Plug-in Blocks**

**Dovetail Base Mounted On Standard #60 Channel**

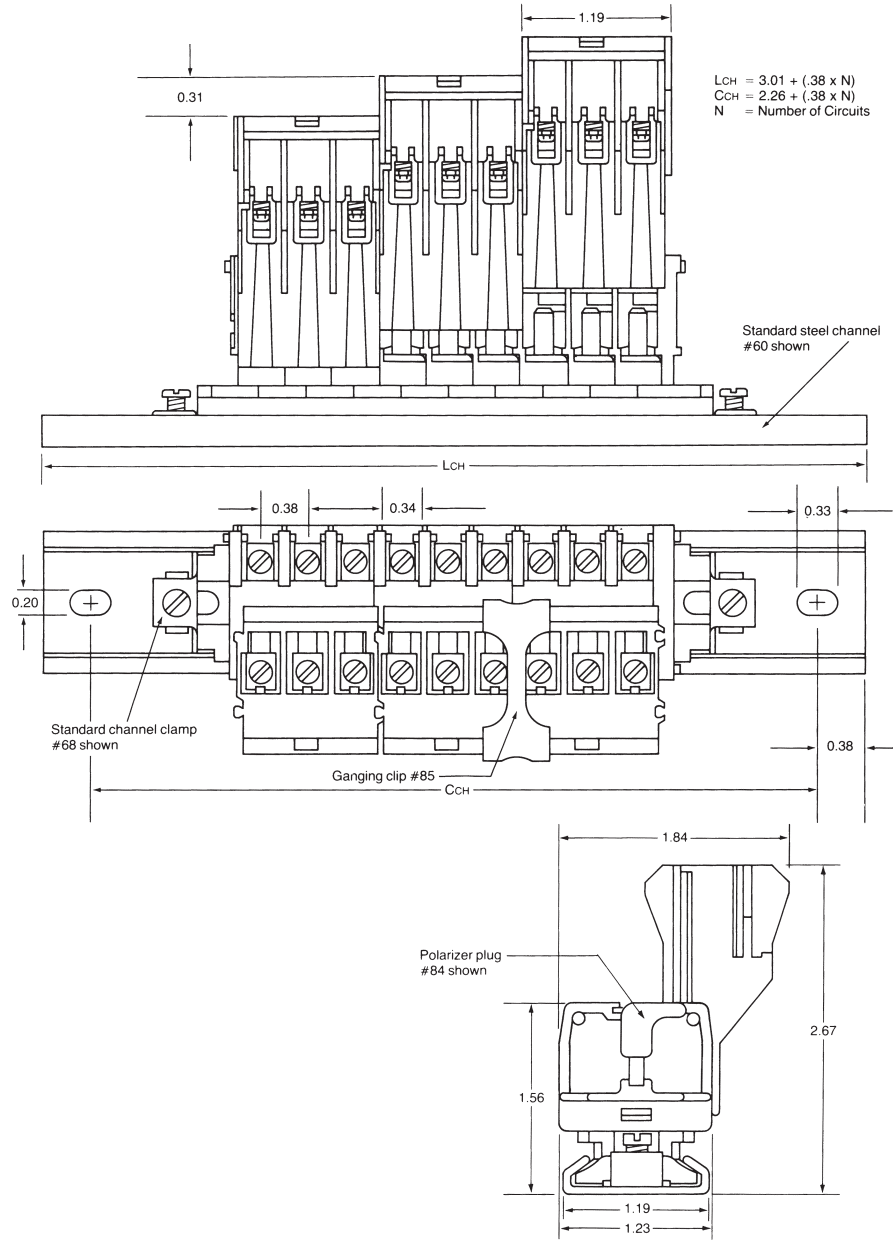

NEMA Terminal Blocks **6**

**Note:** All part numbers  
are RoHS Compliant.

---

## Engineering Notes

---



## 200 Series Heavy Duty

### Product Facts

- n Choose from 5 different contact styles.
- n 600 volt UL and NEMA rating.
- n Conservatively rated from 50 to 90 amperes per circuit, depending on which contact style is selected.
- n Choose any of three mounting methods — two-way flat base models surface mount directly to the panel or snap-on miniature channel. Dovetail base models mount on standard channel.
- n Packaged for rapid handling and assembly — snap-fit sections are packed 10 per carton.
- n Only one end section needed per block assembly.
- n Readily identify circuits — mark directly on block sections or use removable marking strip. Pre-printed strips are also available.

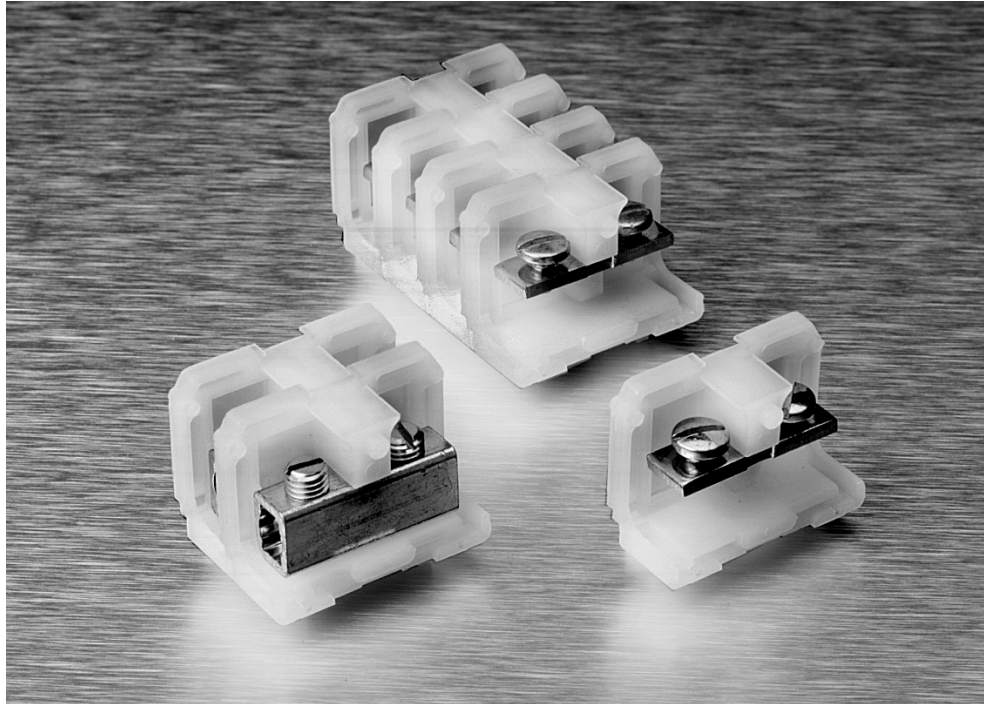

This compact, heavy duty block line accepts single or combination wires up to #4 AWG, solid or stranded. The compact design allows at least 138 circuits per 6-foot length to be mounted. The pitch of this 600 volt block is 0.50" [12.70] (centerline spacing).

**Note:** All part numbers are RoHS Compliant.

**200 Series, Heavy Duty, 600V, 0.50" [1.27] Pitch**

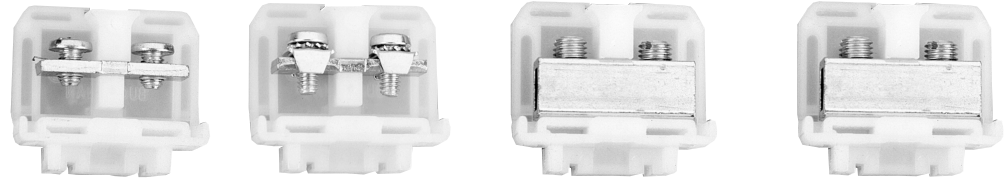

**Characteristics**      **Strap Screw**      **Strap Clamp**      **Tubular Screw**      **Tubular Clamp**

Type of Block	Strap Screw		Strap Clamp		Tubular Screw		Tubular Clamp	
	Model	Part Number	Model	Part Number	Model	Part Number	Model	Part Number
<b>Direct Mount (Flat Base)</b>								
Nylon, Unpainted	241	3-1437390-9	248	4-1437390-2	242	4-1437390-0	243	4-1437390-1
Polypropylene	P241	6-1437390-5	P248	6-1437390-8	P242	6-1437390-6	P243	6-1437390-7
<b>Channel Mount (Dovetail Base)</b>								
Nylon, Painted	0241	1-1437390-6	0248	2-1437390-4	0242	2-1437390-0	0243	2-1437390-1
Polypropylene	P0241	5-1437390-9	P0248	6-1437390-3	P0242	6-1437390-0	P0243-BU	6-1437390-2

**Contact Type**



**Specifications**

	Strap Screw	Strap Clamp	Tubular Screw	Tubular Clamp
Wire Range (AWG) Solid & Stranded	22-10	18-8	18-4	18-6
Wire Strip Length (in.)	—	1/2	1/2	1/2
Screw Type	10-32 binding head	8-32 pan head	1/4-28 set screw	1/4-28 set screw
Ampacity	35 A	50 A	85 A	65 A

**End Sections**

	Strap Screw	Strap Clamp	Tubular Screw	Tubular Clamp
Direct Mount, Nylon	250	4-1437390-3	250	4-1437390-3
Direct Mount, Polypropylene	P250	6-1437390-6	P250	6-1437390-6
Channel Mount, Nylon	0250	2-1437390-5	0250	2-1437390-5
Channel Mount, Polypropylene	P0250	6-1437390-4	P0250	6-1437390-4

**Notes:**

For factory assembled blocks, suffix Catalog Number with number of blocks desired. See page 264-266 for dimensions and other details. (Maximum number of flat base preassembled sections is 12).  
Example: Ten tubular clamp, dovetail based sections, preassembled on channel = 024310

Example: Twelve polypropylene strap clamp flat base sections = P24812

For unpainted factory assembled blocks supplied with a removable marking strip add — 1 to Catalog Number.

For blocks with two or more different contact sections, imprinted marking strips, or special features, consult Technical Support.

**Comparison (Type of Block)**

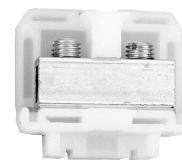

**Direct Mount (Flat Base)**



**Channel Mount (Dovetail Base)**



**Note:** All part numbers are RoHS Compliant.

**200 Series, Heavy Duty, 600V, 0.50" [1.27] Pitch** (Continued)





**Corrosion Resistant Strap Screw**



**Corrosion Resistant Tubular Screw**

Model	Part Number	Model	Part Number
D241	4-1437389-0	D242	4-1437389-1
DP241	1776721-1	DP242	1776723-1
D0241	1776722-1	D0242	1776724-1
DP0241	6-1437389-0	DP0242	1776724-2

	
22-10	18-4
—	1/2
10-32 Nickel plated binding head	1/4-28 Nickel plated set screw
35 A	85 A

250	4-1437390-3	250	4-1437390-3
P250	6-1437390-6	P250	6-1437390-6
O250	2-1437390-5	O250	2-1437390-5
P0250	6-1437390-4	P0250	6-1437390-4



## 200 Series Heavy Duty Accessories

### Mounting Channel



Miniature		Steel Channel		Break Away Steel		Pre-punched Aluminum Channel	
Part Number	Catalog Number	Part Number	Catalog Number	Part Number	Catalog Number	Part Number	Catalog Number
1437381-8	12	9-1437381-1 9-1437381-8	60 63-BU	9-1437381-2	60-B-36	9-1437381-9 1437382-2	64 67
<b>Standard Length</b>							
3 feet		6 feet 3 feet		3 feet		6 feet 3 feet	

### Channel Clamps

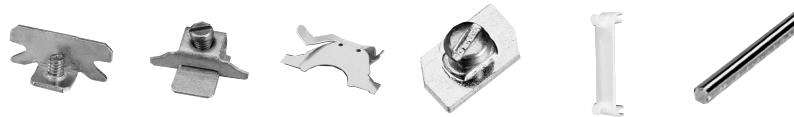

Screw Channel Clamps	Universal Clamps	Snap-In Clamps	Miniature for #12 Channel	See-thru Cover	Ganging Rod
<b>Part Number</b>					
9-1437381-5	1437382-3	9-1437381-7	1437381-4	1-1437381-6	3-1437381-9
<b>Catalog Number</b>					
61	68	62	11	23-BU	30-BU
<b>Standard Length</b>					
—	—	—	—	—	2 feet

### Marking Accessories

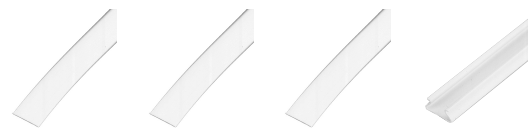

### Jumpers



Plastic Cloth Tape	Plastic Cloth Tape	Vinyl Marking Strips	Elevated Marking Strip	Nylon Holding Plug	Jumper for Tubular Contacts	Snap-Apart for Tubular Contacts
<b>Part Number</b>						
8-1437381-1	8-1437381-0	6-1437381-3	4-1437391-1	4-1437393-0	2-1437393-4	1-1437382-5
<b>Catalog Number</b>						
56	55-BU	50-BU	52-BU	65-BU	42-BU	75
<b>Standard Length</b>						
—	50 feet	25 feet	18 inches	—	—	12 ckt

### Related Product Data

**Wire Pins and Ferrules**—Pages 109-111  
For more information on AMP Standard Terminals and Splices or Quick-Connect FASTON Receptacles and Tabs, request Catalog 82042.





## 200 Series Heavy Duty Specifications

### Material & Finish

**Voltage Rating:** Blocks meet 600 volt creepage and clearance requirements of NEMA, UL and CSA for general industrial control equipment and panelboards. Withstand voltages greatly in excess of IEEE switchgear standards for 750 volts.

**Ampacity:** For a single #4 AWG wire the maximum amperage recommended is 85 amps.

### Standard Contacts:

**Material:** Electrical grade copper or copper alloy conductor. Steel Screws plated to resist corrosion in most industrial applications

**AL-CU Tubular Screw:** Aluminum compatibility with aluminum or copper conductors. AL-CU is tin-plated brass.

### Environmental Contacts (for highly corrosive atmospheres)

**Tubular Screw:** Electrical grade copper tube with nickel plating. Nickel plated brass screws.

**Strap Screw:** Nickel plated brass straps and screws. Nickel plating exceeds specification QQ-N-290 Class I, Type VII.

### Nylon Housing:

**Material**—Nylon; Unfilled Type 6/6

**Max. Continuous Temperature**—125°C [257°F]

### Breakdown Voltage (AC, 60 Hz)

Contact-to-Contact: 7000V

Contact-to-Ground: 7800V

**Dielectric Strength (RH 40% at Sea Level)**—470-385 Volts/mil thickness Per ASTM D149

**UL High Voltage Arc Tracking (inches/min.)**—.01-.35

**Water Absorption (24 hrs. % wt. gain)**—1.5%

**Flammability**—UL94V-2

**Chemical Resistance**—Resistant to aromatic hydrocarbons, strong alkalis Per ASTM D543

**Radiation Resistance (ergs g-1 (C))**—8 x 10<sup>7</sup>

**Color**—Translucent White

### Independent Testing Service Listing and Recognition

WIRE SIZES, Solid or Stranded

Tubular Screw

1 #4 AWG, 1 #6 AWG,

1 or 2 #8 AWG, 1 to 4 #10 AWG,

1 or 5 #12 AWG, 1 to 4 #14 AWG,

1 or 6 #16 AWG, 1 to 8 #18 AWG,

Tubular Clamp

1 #6 AWG, 1 or 2 #8 AWG,

1 to 3 #10 AWG, 1 to 4 #12 AWG,

1 or 4 #14 AWG, 1 to 6 #16 AWG,

1 or 8 #18 AWG

Strap Clamp

1 #18 to 1 #8 AWG

### Polypropylene Housing:

**Material**—Polypropylene; Filled self-extinguishing

**Max. Continuous Temperature**—105°C (221°F)

### Breakdown Voltage (AC, 60Hz)

Contact-to-Ground: 7800V

Contact-to-Contact: 7000V

**Dielectric Strength (RH 40% at Sea Level)**—500 Volts/mil thickness Per ASTM D149

**UL High Voltage Arc Tracking (inches/min.)**—Did not Track

**Water Absorption (24 hrs. % wt. gain)**—0.02% Per ASTM D570

**Flammability**—UL94V-0

**Chemical Resistance**—Resistant to most acids, alkalines, and saline solutions. Also resistant to higher aliphatic solvents and polar substances per ASTM D543

**Radiation Resistance (ergs g-1 (C))**—No data Available

**Color**—Opaque White

**Note:** All part numbers are RoHS Compliant.

**200 Series, 600 Volt, Direct Mount**

**Flat Base**

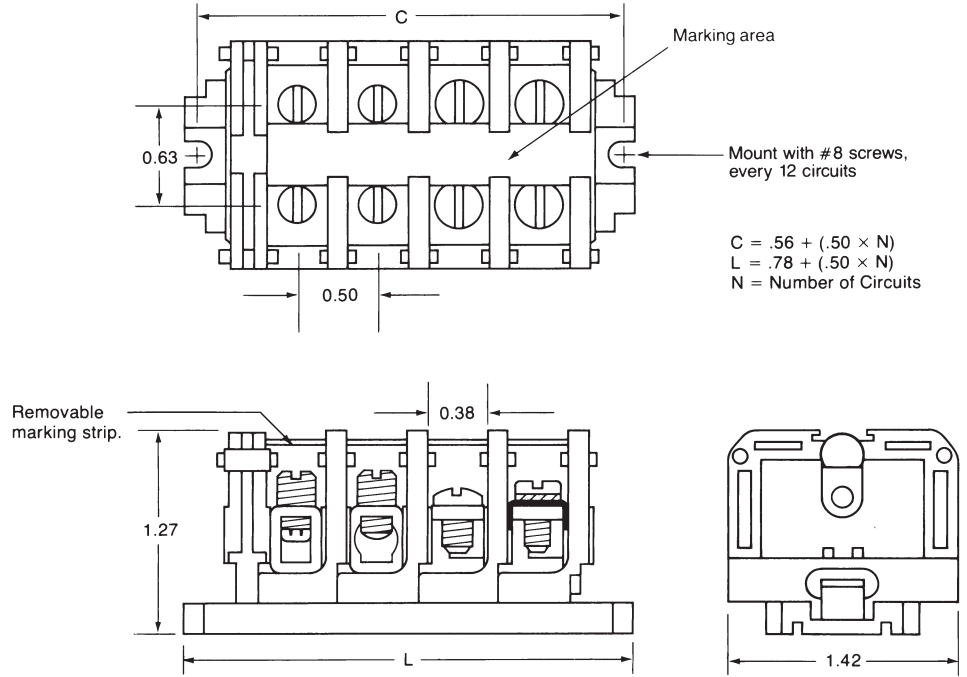

**Note:** All part numbers are RoHS Compliant.

**200 Series, 600 Volt, Channel Mount**

**Flat Base Mounted On #12 Miniature Channel**

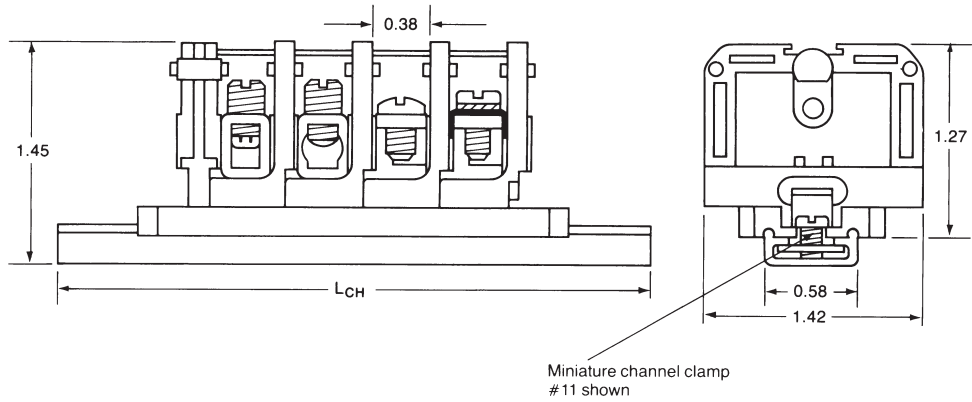
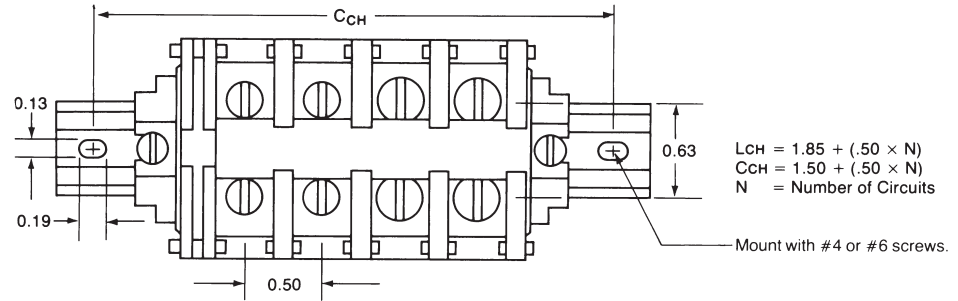

NEMA Terminal Blocks **6**

**Note:** All part numbers are RoHS Compliant.

**200 Series, 600 Volt, Channel Mount (Standard)**

**Dovetail Base Mounted On Standard #60 Channel**

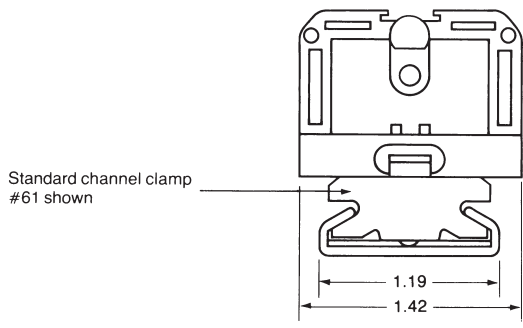
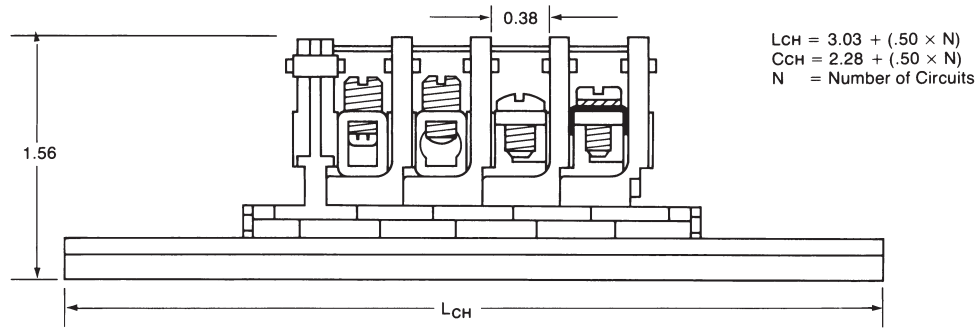
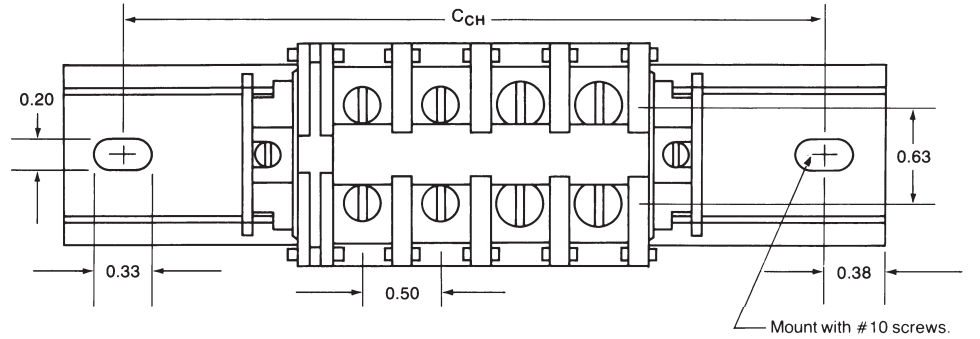

## 200 Series, Heavy Duty Phenolic Blocks

### Product Facts

- n **Sturdy Heavy Duty block accepts single or combinations of wire up to #4 AWG solid or stranded — at least 122 circuits per 6-foot length, 9/16" center-to-center spacing.**
- n **Choose from four different contact styles conservatively rated up to 90 amperes.**
- n **600 volt UL and NEMA rating.**
- n **Surface mounted flat base and channel mounted dovetail base models available.**
- n **Only one end section needed per block assembly.**
- n **Interlocking sectional fanning strips allow entire circuit groups to be connected and disconnected as a single unit.**
- n **Readily identify circuits — available with painted marking surface or use removable marking strip. Pre-printed strips are also available.**
- n **Factory assembled blocks available.**
- n **Heavy Duty Phenolic Block Sections Snap-fit with 300 & 600 volt, medium duty phenolic, heavy duty nylon and polypropylene, and Fuse and Switch blocks.**

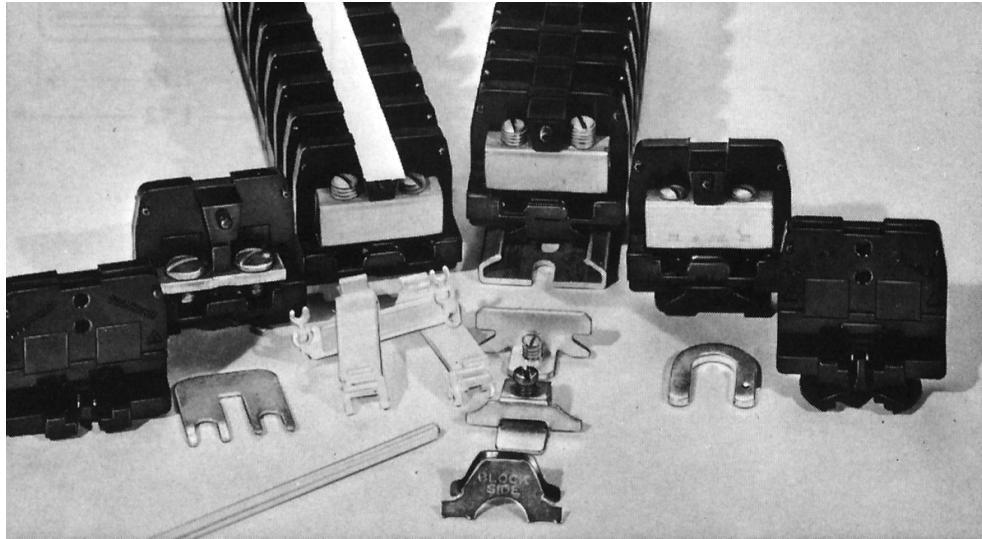

This family of phenolic heavy duty blocks is ideal for high temperature, high current applications. The rugged material withstands temperatures up to 302°F [150°C].

**Note:** All part numbers are RoHS Compliant.

**200 Series, Heavy Duty Phenolic, 600 V, 0.56" [14.24] Pitch**

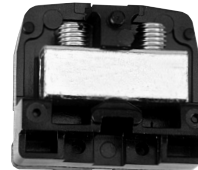
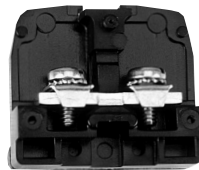
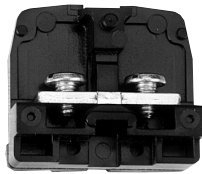

**Characteristics**

**Strap Screw**

**Strap Clamp**

**Tubular Screw**

**Tubular Clamp**

Type of Block	Model	Part Number	Model	Part Number	Model	Part Number	Model	Part Number
<b>Direct Mount (Flat Base)</b>								
Painted	221	3-1437390-1	228-BU	1-1437381-5	222-BU	3-1437390-3	223-BU	3-1437390-6
Unpainted	211	2-1437390-7	218	3-1437390-0	212	2-1437390-8	213	2-1437390-9
<b>Channel Mount (Dovetail Base)</b>								
Painted	0221	1437390-8	0228	1-1437390-3	0222	1437390-9	0223	1-1437390-2
Unpainted	0211	1437390-1	0218	1437390-7	0212	1437390-3	0213	1437390-5
<b>Contact Type</b>								



**Specifications**

Wire Range (AWG) Solid & Stranded	22-10	18-8	18-4	18-6
Wire Strip Length (in.)	—	1/2	1/2	1/2
Screw Type	10-32 binding head	8-32 pan head w/clamp	1/4-28 set screw	1/4-28 set screw
Ampacity	35 A	50 A	85 A	65 A
<b>End Sections</b>				
Direct Mount	230-BU 1-1437381-7	230-BU 1-1437381-7	230-BU 1-1437381-7	230-BU 1-1437381-7
Channel Mount	0230 1-1437390-4	0230 1-1437390-4	0230 1-1437390-4	0230 1-1437390-4

**Notes:**

For factory assembled blocks, suffix Catalog Number with number of blocks desired. See page 272 for dimensions and other details. (Maximum number of flat base preassembled sections is 12).

Example: Twenty dovetail based, tubular clamp blocks, preassembled on channel = 021320 (plain marking area)

Example: Twelve preassembled flat base, strap screw blocks = 22112 (painted marking area)

For factory assembled blocks supplied with a removable marking strip add — 1 to Catalog Number.

For blocks with two or more different contact sections, imprinted marking strips, or special features, consult Technical Support.

Environmental contacts for highly corrosive atmospheres are available with nickel plating on non-ferrous hardware. To order, prefix Catalog # with "D".

**Comparison (Type of Block)**

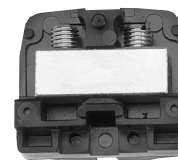

**Direct Mount  
(Flat Base)**

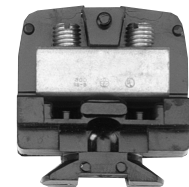

**Channel Mount  
(Dovetail Base)**



**Note:** All part numbers are RoHS Compliant.

**200 Series, Heavy Duty Phenolic, 600 V, 0.56" [14.24] Pitch (Continued)**

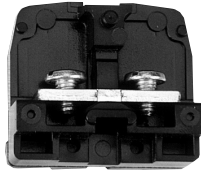

**Corrosion Resistant Strap Screw**



**Corrosion Resistant Tubular Screw**



**Corrosion Resistant Tubular Clamp**

Model	Part Number	Model	Part Number	Model	Part Number
D221	3-1437389-6	D222	3-1437389-8	D223	3-1437389-9
D211	3-1437389-4	D212	3-1437389-5	D213	4-1437390-6
D0221	1437389-7	D0222	1437389-8	D0223	1437389-9
D0211	1437389-2	D0212	1437389-4	D0213	1437389-6

**Contact Type**



**Specifications**

22-10	18-4	22-10
—	1/2	1/2
10-32 Nickel plated binding head	1/4-28 Nickel plated set screw	1/4-28 Nickel plated set screw
35 A	85 A	65 A
230-BU 1-1437381-7	230-BU 1-1437381-7	230-BU 1-1437381-7
0230 1-1437390-4	0230 1-1437390-4	0230 1-1437390-4

NEMA Terminal Blocks **6**

**Sectional Fanning Strips**

Description	Part No.	Catalog No.
Tubular Screw	1-1437381-8	24
Strap Screw	1-1437381-9	27
Molding Only, no contact	1447889-1	2400

**Note:**

For factory assembled fanning strips, suffix Catalog Number with number desired.

Example: Ten factory assembled sections of #24 = 2410

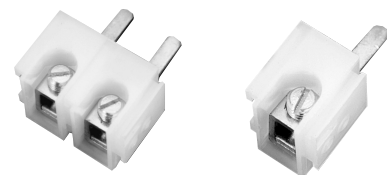

**Note:** All part numbers are RoHS Compliant.

## 200 Series, Heavy Duty Phenolic Accessories

### Mounting Channel

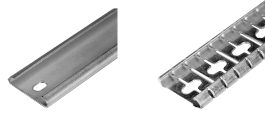

### Channel Clamps



Steel Channel	Break Away Steel	Pre-punched Aluminum Channel	Screw Channel Clamps	Universal Clamps	Snap-In Clamps	See-thru Cover	Ganging Rod
<b>Part Number</b>							
9-1437381-1 9-1437381-8	9-1437381-2	9-1437381-9 1437382-2	9-1437381-5	1437382-3	9-1437381-7	1-1437382-2	3-1437381-9
<b>Catalog Number</b>							
60 63-BU	60-B-36	64 67	61	68	62	23-BU	30-BU
<b>Standard Length</b>							
6 feet 3 feet	3 feet	6 feet 3 feet	—	—	—	—	2 feet

### Marking Accessories

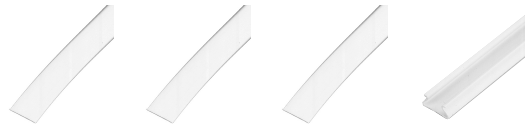

### Jumpers



Plastic Cloth Tape	Plastic Cloth Tape	Vinyl Marking Strips	Elevated Marking Strip	Nylon Holding Plug	Jumper for Tubular Contacts	Jumper for Strap Screw
<b>Part Number</b>						
8-1437381-1	8-1437381-0	6-1437381-3	4-1437391-1	4-1437393-0	2-1437393-3	5-1437381-5
<b>Catalog Number</b>						
56	55-BU	50-BU	52-BU	65-BU	41-BU	43
<b>Standard Length</b>						
10 sheets	50 feet	25 feet	18 inches	—	—	—

### Related Product Data

**Wire Pins and Ferrules**—Pages 109-111  
 For more information on AMP Standard Terminals and Splices or Quick-Connect FASTON Receptacles and Tabs, request Catalog 82042.



## 200 Series, Heavy Duty Phenolic Specifications

### Material & Finish

#### Standard Contacts

**Material:** Electrical grade copper or copper alloy conductor. Steel Screws plated to resist corrosion in most industrial applications.

#### Environmental Contacts (for highly corrosive atmospheres)

**Tubular Screw:** - Electrical grade copper tube with nickel plating.

Nickel plated brass screws.

**Strap Screw:** - Nickel plated brass straps and screws

Nickel plating exceeds specification QQ-N-290 Class I, Type VII.

**Wire Range:** Strap Screw: #22-10 AWG max., solid or stranded with crimp terminals

**Strap Clamp:** #18-8 AWG, solid or stranded

**Tubular Screw:** #18-4 AWG, solid or stranded

**Tubular Clamp:** #18-6 AWG, solid or stranded

**Wire Strip Length:** Strap Screw: As needed for lugging

**Strap Clamp:** 1/2 in. [12.7]

**Tubular Screw:** 1/2 in. [12.7]

**Tubular Clamp:** 1/2 in. [12.7]

**Screw Type:** Strap Screw: 10-32 slotted binding head

**Strap Clamp:** 8-32 pan head w/ clamp

**Tubular Screw:** 1/4-28 slotted headless

**Tubular Clamp:** 1/4-28 slotted headless

**Strap Screw:** Maximum width of lugs: 11/32 in. [8.73]

### Independent Testing Service Listing and Recognition

WIRE SIZES, Solid or Stranded Tubular Screw

Tubular Screw

1 #4 AWG, 1 #6 AWG,

1 or 2 #8 AWG, 1 to 4 #10 AWG,

1 or 5 #12 AWG, 1 to 6 #14 AWG,

1 or 6 #16 AWG, 1 to 8 #18 AWG,

Tubular Clamp

1 #6 AWG, 1 or 2 #8 AWG,

1 to 3 #10 AWG, 1 to 4 #12 AWG,

1 or 4 #14 AWG, 1 to 6 #16 AWG,

1 or 8 #18 AWG

Strap Clamp

1 #18 to 1 #8 AWG

### Nylon Housing

**Material**—Phenolic, Filled Flame Retardant

**Max. Continuous Temperature**—150°C, [302°F]

**Breakdown Voltage**—

Contact-to-Contact: 7800V

Contact-to-Ground: 9400V

**Dielectric Strength (RH 40% at Sea Level)**—300 Volts/mil thickness per ASTM #D149

**UL High Voltage Arc Tracking (Inches/min.)**—.49-.58 [12.45-14.73]

**Water Absorption (24 hrs. % wt. gain)**—0.45% per ASTM D570

**Flammability**—UL94V-1

**Chemical Resistance**—Resistant to acids, alkalis, and aliphatic hydrocarbons and ketones, per ASTM D543.

**Radiation Resistance (ergs g-1 (C))**—2.7 x 108 min.

**Color**—Black

**Note:** All part numbers are RoHS Compliant.

**200 Series, Heavy Duty Phenolic**

**Flat Base**

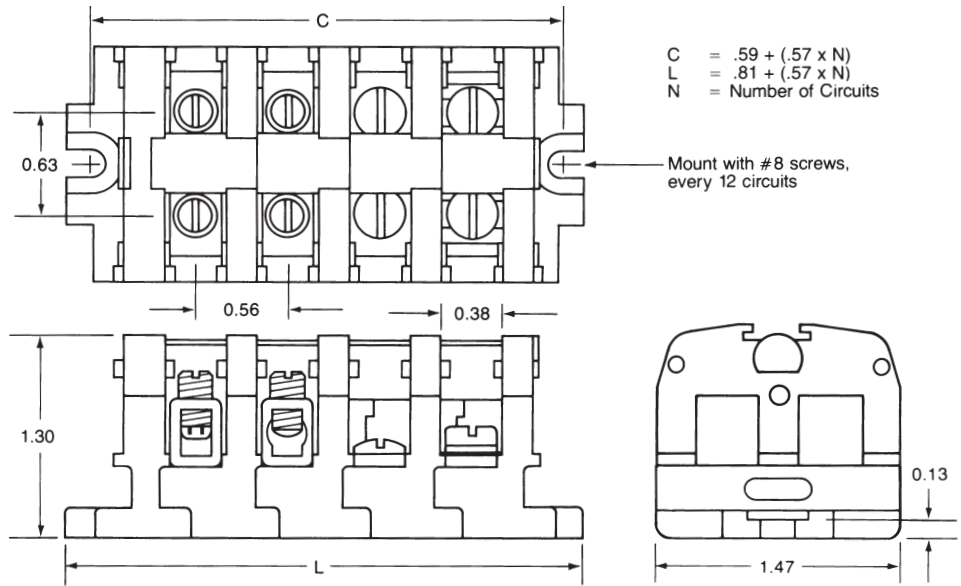

**Dovetail Base Mounted On Standard #60 Channel**

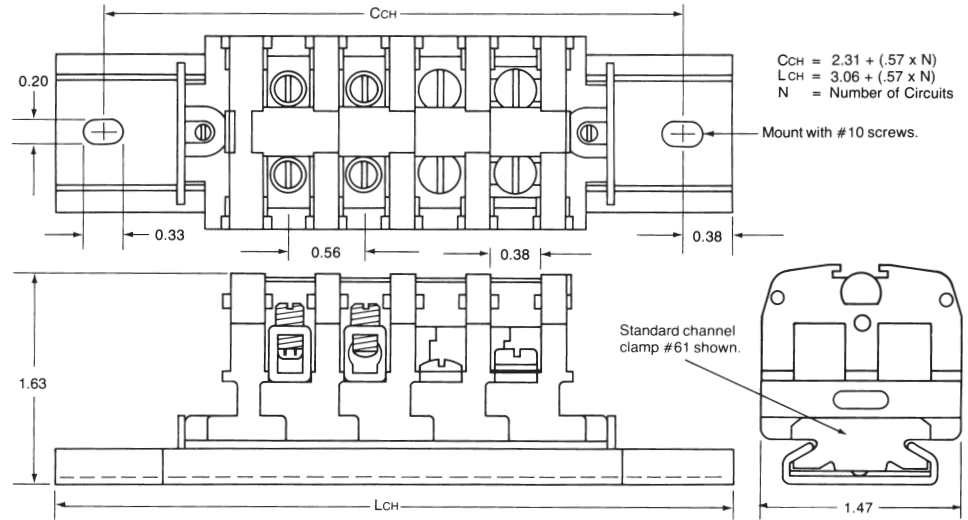

**Sectional Fanning Strips**

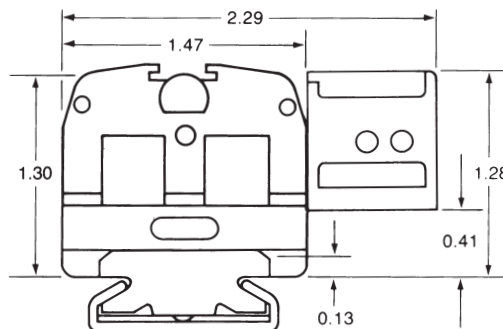

## 800 Series, Intermediate Heavy Duty

### Product Facts

- n An exceptionally compact block that accepts single or combinations of AWG wire sizes as large as #1/0 — at least 92 circuits per 6-foot length, 3/4 inch center-to-center spacing.
- n Tubular screw contact style accepts AWG wire sizes from #12 thru #1/0, solid or stranded.
- n Same block mounts on surface or channel — two-way mounting base fits standard channel or mounts directly to flat surfaces.
- n Packaged for rapid handling and assembly — snap-fit sections packaged 10 per carton.
- n Contacts conservatively rated at 155 amperes per circuit when used with copper wire.
- n Only one end section needed per block assembly.
- n Readily identify circuits — blocks available with painted marking surface or use removable vinyl marking strip. Preprinted marking strips are also available.
- n Factory assembled blocks available.
- n Nylon housing material for the most rugged applications.
- n Allen head screw for aluminum wire — screw tip design helps protect aluminum wire from overtightening. Slotted screw head for copper wire.
- n Intermediate Heavy Duty blocks snap-fit with 300 & 600V, Medium Duty phenolic, Heavy Duty nylon, polypropylene and phenolic and Fuse and Switch blocks.

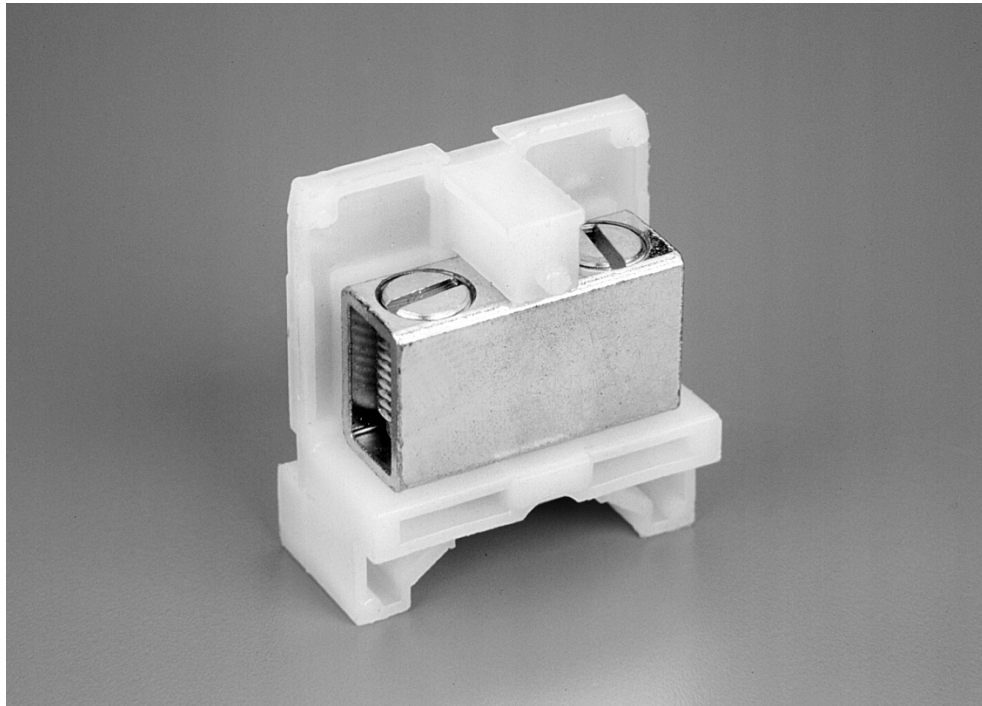

This line of 600 volt blocks is rated up to 150 A and is available in a standard version and a corrosion resistant version.

**800 Series, Intermediate Heavy Duty, 600 V, 0.75" Pitch**

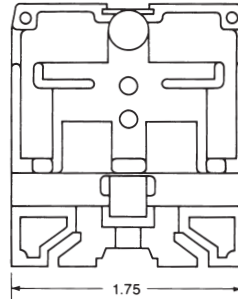
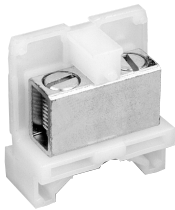

Same part used for both panel and channel mounting.

**Material & Finish**

**Housing Material**—Polyamide type 6/6, unfilled

**Max Continuous Temp.**—125°C [257°F]

**Water Absorption (24hrs. % wt. gain)**—1.5%

**Flammability**—UL94V-2

**Chemical Resistance**—Resistant to aromatic hydrocarbons, strong alkalis

**Radiation Resistance (ergs g-1 (C))**—8 x 10<sup>7</sup>

**Color**—Translucent white

**Electrical Properties**

**Voltage Rating**—Blocks meet 600V clearance and creepage requirements of NEMA, UL, and CSA standards for general industrial control equipment and panelboards. Withstand voltages in excess of IEEE switchgear standards for 750V.

**Breakdown Voltage, AC, 60Hz**—  
Contact-to-Contact: 8,800V  
Contact-to-Ground: 9000V

**Dielectric Strength — RH 40% @ Sea Level**—470-385 Volts/mil thickness per ASTM D149

**Operating Voltage**—Blocks meet 600V creepage and clearance requirements; withstand voltage greatly exceeds standards for 750V

**UL High Voltage Arc Tracking (in./min.)**—0.1-.35 [0.25-8.89]

**Contacts**

**Standard Contacts**

**Material**—Electrical grade copper conductor

**Screws**—Steel, zinc plated to resist corrosion in most applications

**Duramax Contacts (for highly corrosive atmospheres)**

**Tubular Screw**—Electrical grade copper tube with nickel plating; nickel plated brass screws. Nickel plating exceeds specification QQ-N-290 Class 1, Type VII.

**Wire Range**—#12-1/0 AWG, solid or stranded

**Wire Strip Length**—11/16" [17.46]

**Screw Type**—7/16" [11.11] - 20 slotted headless screw

**Independent Testing Service Listing and Recognition**

**UL Wire Sizes**—Solid or Stranded, Tubular Screw

- 1 — #1/0 AWG, 1 — #1 AWG
- 1 — #2 AWG, 1 or 2 — #4 AWG
- 1, 2 or 3 — #6 AWG,
- 1, 2, 3 or 5 — #8 AWG
- 1 to 6 — #10 AWG, 1 to 7 — #12 AWG

Description	Part No.	Catalog No.
Tubular Screw, Unpainted	1437395-2	814
Tubular Screw, Painted	1437395-3	824-BU
Corrosion Resistant, Unpainted	5-1437389-8	D814-BU
Corrosion Resistant, Painted	5-1437389-9	D824
End Section	1-1437395-4	830-BU

**Notes:**

For factory assembled blocks on channel, prefix Catalog # with "0" and suffix with number of blocks desired. Without channel (maximum of 6 sections) delete "0". See page 275 for dimensions and other details.

Example: Ten tubular screw sections preassembled on channel = 082410

For unpainted factory assembled blocks supplied with a removable marking strip add -1 to Catalog Number.

For blocks with two or more different contact sections, imprinted marking strips or special features; consult Technical Support.



**Note:** All part numbers are RoHS Compliant.

**800 Series, Intermediate Heavy Duty Accessories**

**Mounting Channel**

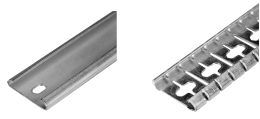

**Channel Clamps**

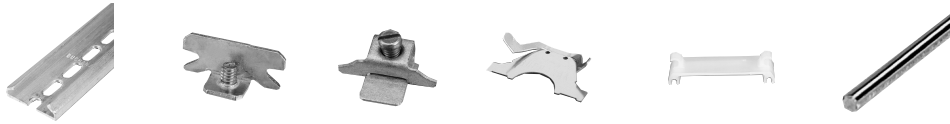

Steel Channel	Break Away Steel	Pre-punched Aluminum Channel	Screw Channel Clamps	Universal Clamps	Snap-In Clamps	See-thru Cover	Ganging Rod
<b>Part Number</b>							
9-1437381-1 9-1437381-8	9-1437381-2	9-1437381-9 1437382-2	9-1437381-5	1437382-3	9-1437381-7	4-1437390-4	3-1437381-9
<b>Catalog Number</b>							
60 63-BU	60-B-36	64 67	61	68	62	93-BU	30-BU
<b>Standard Length</b>							
6 feet 3 feet	3 feet	6 feet 3 feet	—	—	—	—	2 feet

**Marking Accessories**

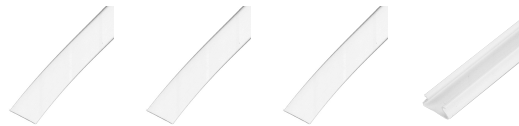

**Jumpers**



Plastic Cloth Tape	Plastic Cloth Tape	Vinyl Marking Strips	Elevated Marking Strip	Holding Screw	Snap-apart Jumper
<b>Part Number</b>					
1437382-1	8-1437381-0	6-1437381-3	4-1437391-1	7-1437381-8	1-1437382-6
<b>Catalog Number</b>					
66	55-BU	50-BU	52	53-BU	76
<b>Standard Length</b>					
—	50 feet	25 feet	18 inches	—	12 ckt

**RELATED PRODUCT DATA**

**WIRE PINS AND FERRULES:** Pages 109-111  
For more information on AMP Standard Terminals and Splices or Quick-Connect FASTON Receptacles and Tabs, request Catalog 82042.

**Note:** All part numbers are RoHS Compliant.

**800 Series, Intermediate Heavy Duty**

**Flat Base**

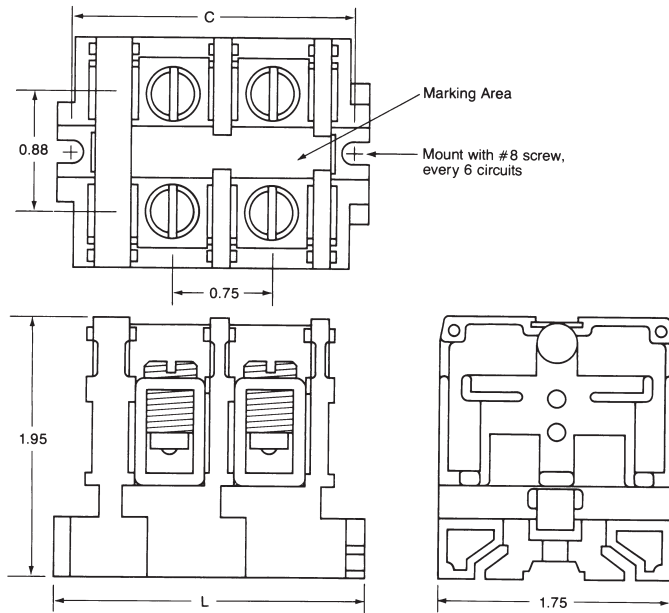

**Dovetail Base Mounted On Standard #60 Channel**

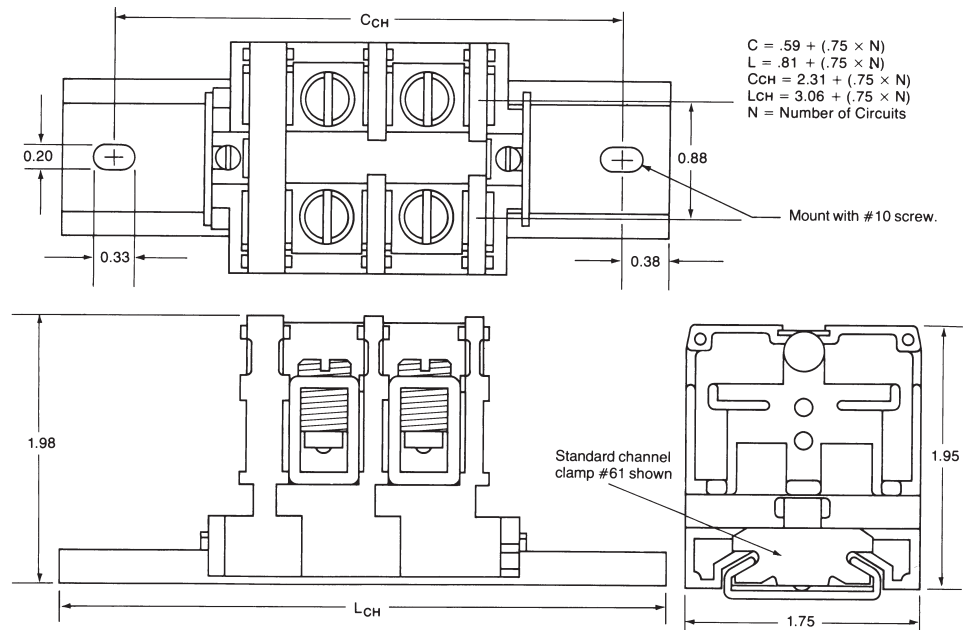

## 400 Series, Ultra Heavy Duty

### Product Facts

#### 400 Series

- Compact 2/0 or 250 kcmil (MCM) block - at least 57 circuits per 6-foot length, 1-3/16" [30.16] center-to-center spacing.
- High current capacity snap-fit sectional block — tubular contacts accept single or combinations of wire sizes as large as 250 kcmil (MCM).
- Two contact styles available; rated up to 270 amperes for copper wire.
- Allen head screws allow maximum torque when using large wire sizes.
- Withstand voltages in excess of IEEE switchgear standards for 750 volts. Meet clearance and creepage spacing specified in UL, CSA, and NEMA Industrial Control Standards for 600 volts.
- Same block directly mounts on surface or channel mounts.
- Only one end section needed per block assembly.
- Readily identify circuits—order blocks with painted marking area or use removable vinyl marking strip. Preprinted marking strips are also available.
- Factory assembled blocks available.
- Ultra Heavy Duty phenolic block sections do not snap-fit with other block styles.



This Ultra Heavy Duty line includes the 400 Series rated up to 270 A.

**400 Series, Ultra Heavy Duty, 600 V, 1.19" [30.23] Pitch**

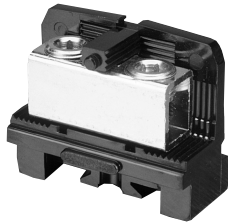

**Material & Finish**

**Housing Material**—Phenolic, filled flame retardant

**Flammability**—UL94V-1

**Color**—Black

**Contacts:**

**Material**—Electrical grade copper conductor; plated steel screws resist corrosion

**Tubular Screw Type**—

- Small: 1/2" [12.7] - 13 Hex
- Large: 3/4" [19.05] - 16 Hex socket set screw

**Mechanical Properties**

**Pitch (terminal spacing)**—1.19" [30.23]; 9 circuits/foot

**Wire Strip Length**—  
Tubular Screw (small): 1" [25.4]  
Tubular Screw (large): 1" [25.4]

**Electrical Properties**

**Maximum Current**—255A for a single 250MCM wire

**Operating Voltage**—Blocks meet 600V creepage and clearance requirements; withstand voltage greatly exceeds standards for 750V

**Wire Range**—Tubular Screw (small): #4-#2/0 AWG solid or stranded; Tubular Screw (large): #6 AWG-250 kcmil (MCM) solid or stranded

**Dielectric Strength (RH 40% @ sea level)**—300 V/mil thickness per ASTM D149

**Breakdown Voltage, AC, 60Hz**—  
Contact-to-Contact: 10,000V  
Contact-to-Ground: 10,000V

**UL High Voltage Arc Tracking (in./min.)**—49-.58 [12.45-14.73]

**Environmental Properties**

**Max. Continuous Temperature**—150°C [302°F]

**Water Absorption (24hrs. % wt. gain)**—.45% per ASTM D149

**Chemical Resistance**—Resistant to acids, alkalis, and aliphatic hydrocarbons and ketones per ASTM D543

**Radiation Resistance (ergs g-1 (C))**—2.7 x 108

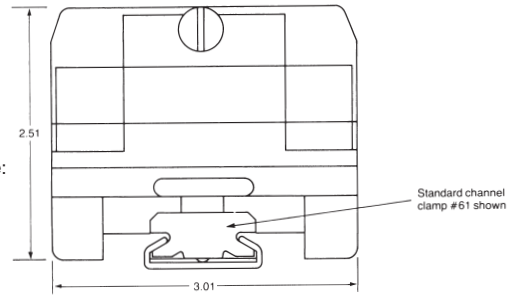
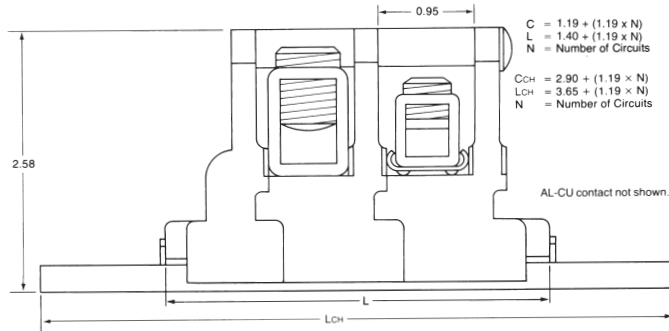
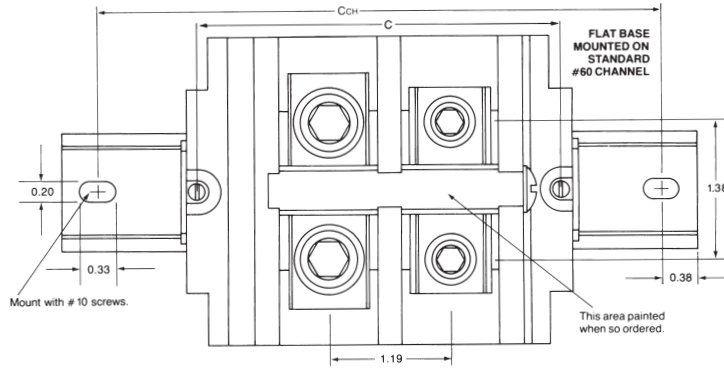

**Note:** For Direct Mounting, use #10 pan head screws every six circuits. recommended torque: 15-20 in.-lbs.

**Same part used for both panel and channel mounting.**

Description	Wire Range	Part Number	Catalog Number
Tubular Screw, Unpainted	#14-2/0	1437396-4	416
Tubular Screw, Painted	#14-2/0	1437396-7	426-BU
Tubular Screw, Unpainted	#6-250 kcmil/MCM	1437396-5	417
Tubular Screw, Painted	#6-250 kcmil/MCM	1437396-8	427-BU
End Section	—	1437396-9	430-BU

**UL Independent Testing Service Recognitions:**

**Tubular Screw:** Catalog # 416 & 426-BU

- 1 #2/0 AWG, 1 #1/0 AWG, 1 #1 AWG,
- 1 or 2 #2 AWG, 1 to 3 #4 AWG, 1 to 3 #6 AWG,
- 1 to 4 #8 AWG, 1 to 6 #10 AWG, 2 to 8 #12 AWG,

**Tubular Screw:** Catalog # 417 & 427-BU

- 1 #250kcmil (MCM), 1 #4/0 AWG, 1 #3/0 AWG,
- 1 or 2 #2/0 AWG, 1 or 2 #1/0 AWG, 1 or 2 #1 AWG, 1 to 3 #2 AWG, 1 to 4 #4 AWG,
- 1 to 5 #6 AWG





**Note:** All part numbers are RoHS Compliant.

## 400 Series, Ultra Heavy Duty Accessories

### Mounting Channel



### Channel Clamps



Steel Channel	Break Away Steel	Pre-punched Aluminum Channel	Screw Channel Clamps	Universal Clamps	Snap-In Clamps
<b>Part Number</b>					
9-1437381-1 9-1437381-8	9-1437381-2	9-1437381-9 1437382-2	9-1437381-5	1437382-3	9-1437381-7
<b>Catalog Number</b>					
60 63-BU	60-B-36	64 67	61	68	62
<b>Standard Length</b>					
6 feet 3 feet	3 feet	6 feet 3 feet	—	—	—

### Marking Accessories

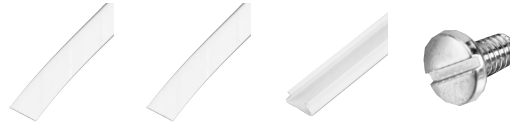

Plastic Cloth Tape	Vinyl Marking Strips	Elevated Marking Strip	Holding Screw
<b>Part Number</b>			
8-1437381-0	6-1437381-3	4-1437391-1	7-1437381-8
<b>Catalog Number</b>			
55-BU	50-BU	52-BU	53-BU
<b>Standard Length</b>			
50 feet	25 feet	18 inches	—

**Notes:**

For factory assembled blocks on channel, prefix Catalog # with "0" and suffix with number of blocks desired. Without channel (maximum of 6 sections) delete "0".

Example: Ten tubular screw sections preassembled on channel = 041710

For unpainted factory assembled blocks supplied with a removable marking strip add -1 to Catalog Number.

For blocks with two or more different contact sections, imprinted marking strips or special features, consult Technical Support.

### Related Product Data

**Wire Pins and Ferrules**—Pages 109-111  
For more information on AMP Standard Terminals and Splices or Quick-Connect FASTON Receptacles and Tabs, request Catalog 82042.

**Note:** All part numbers  
are RoHS Compliant.

---

## Engineering Notes

---



## Fuse & Switch

### Product Facts

#### High Density Blocks

- n Fuse and Switch Blocks rated 15A and 300V.
- n High Density 0.36" [9.14] centerline spacing saves panel space; at least 33 circuits per foot.

#### Fuse Blocks

- n Provide in-line circuit protection for virtually any circuit or group of circuits — select contacts for terminated or unterminated wire.
- n Remove, check and replace fuses safely and quickly — switch action fuse blocks open circuits before fuse can be removed or installed.
- n Contacts conservatively rated to 30 amperes.

#### Switch Blocks

- n Quickly and easily interrupt a circuit or group of circuits — insert switch blocks directly in line. Contacts available for terminated or unterminated wire.
- n Keep circuits open for extended periods — switch blade can be removed entirely from block for lock-out protection.
- n Rated to 15 amperes.

#### Common Features of 300 & 0300 Series

- n At least 91 circuits per 6-foot length, 3/4 inch center-to-center spacing.
- n Blocks meet 600 volt clearance and creepage spacings specified in UL, CSA, and NEMA Industrial Control Standards.
- n Choose nylon housing material — for more rugged applications; polypropylene for fire retardant characteristics.
- n Dovetail base fits standard mounting channel — can also be mounted on flat surfaces.
- n Only one end section needed per block assembly.

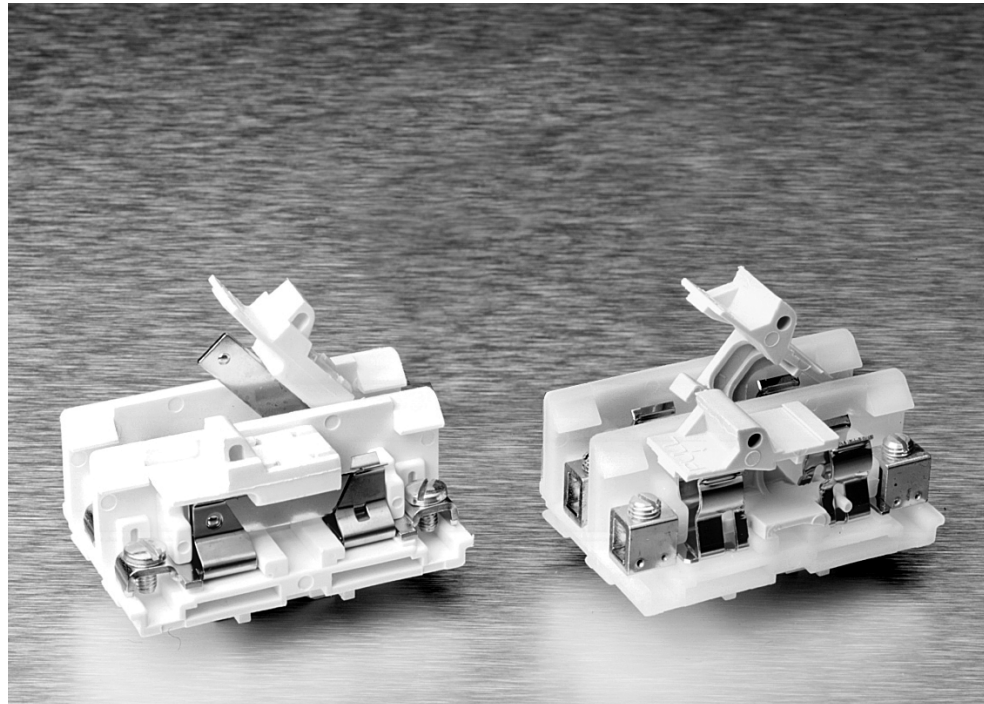

- n Readily identify circuits — mark directly on white, matte-surface puller assembly, marking tab on block, or use removable marking tape.
- n Open or close several circuits simultaneously — holes in puller handles allow use of nylon “ganging” rods.
- n Fuse and Switch block sections snap-fit with 300 & 600 Volt, phenolic Medium Duty, Heavy Duty, and Intermediate Heavy Duty blocks.

This broad line features High Density Blocks (Series 0135), Nylon & Polypropylene Blocks (Series 0300) and Phenolic Blocks (Series 300).



**Note:** All part numbers are RoHS Compliant.

## 0300 Series, Fuse & Switch, Nylon and Polypropylene

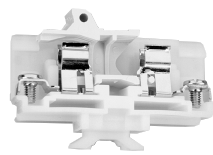

**Fuse Block  
Strap Screw**

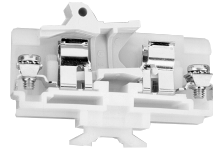

**Fuse Block  
Strap Clamp**

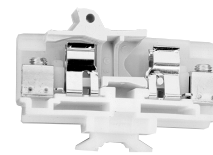

**Fuse Block  
Tubular Screw**

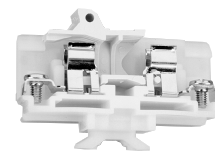

**Switch Block  
Strap Screw**

**Characteristics**

Type of Block	Model	Part Number	Model	Part Number	Model	Part Number	Model	Part Number
<b>Channel Mount (Dovetail Base)</b>								
Nylon	0311	1437397-1	0318	1437397-3	0312	1437397-2	0371	1-1437397-7
Polypropylene	P0311	4-1437397-0	P0318	4-1437397-3	P0312	4-1437397-2	P0371	4-1437397-4
Corrosion Resistant Nylon	D0311	1-1437389-1	D0318	1776726-1	D0312	1-1437389-2	D0371	1-1437389-7
Corrosion Resistant Polypropylene	DP0311	6-1437389-2	DP0318	1776727-1	DP0312	6-1437389-3	DP0371	1776728-1

**Contact Type**



**Specifications**

Wire Range (AWG) Solid & Stranded	22-8	18-8	18-8	22-8
Wire Strip Length (in.)	—	1/2	1/2	—
Screw Type	10-32 binding head	8-32 pan head w/clamp	1/4"-28 set screw	10-32 binding head

**Ampacity**

25 A	25 A	25 A	15 A
------	------	------	------

**End Sections**

Channel Mount, Nylon	0380	2-1437397-0	0380	2-1437397-0	0380	2-1437397-0	0380	2-1437397-0
Channel Mount, Polypropylene	P0380	4-1437397-7	P0380	4-1437397-7	P0380	4-1437397-7	P0380	4-1437397-7

**Notes:** Standard package is 100 pieces for contact, 25 pieces for end section.

For factory assembled blocks on channel, suffix Catalog Number with number of blocks desired. Without channel delete "0" prefix on Catalog Number.

EXAMPLE:

Ten strap-screw fuse block sections preassembled on channel = 031110.

For blocks with two or more contact types, preassembled with other blocks, imprinting or special features, consult Technical Support.

**0300 Series, Fuse & Switch, Nylon and Polypropylene (Continued)**

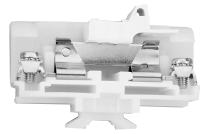

**Switch Block  
Strap Clamp**

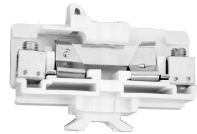

**Switch Block  
Tubular Screw**

Model	Part Number	Model	Part Number
0378	1-1437397-9	0372	1-1437397-8
P0378	4-1437397-6	P0372	4-1437397-5
D0378	1776729-1	D0372	1776731-1
DP0378	1776730-1	DP0372	1776732-1



18-8	18-8		
1/2	1/2		
8-32 pan head w/clamp	1/4"-28 set screw		
15 A	15 A		
0380	2-1437397-0	0380	2-1437397-0
P0380	4-1437397-7	P0380	4-1437397-7

**Fuse Puller:**

Material	High-temperature, glass-reinforced nylon
Color	Black

**Switch Handle:**

Material	Polypropylene
Color	White

**Specifications**

**Pitch**—0.75" [19.05] centerline, 16 circuits per foot

**Voltage Rating**—Blocks meet 600 volt creepage and clearance requirements of NEMA, UL and CSA for general industrial control equipment and panelboards. Withstand voltages greatly in excess of IEE switchgear standards for 750 volts.

**Fuse Size**—Any 13/32 x 1-1/2 in. [10.32 x 28.10] ferrule type cartridge fuse up to 25 amps, indicating or non-indicating, which meets Mil. Spec. F-15160.

**Standard Contacts**

**Material**—Electrical grade copper or copper alloy conductor. Steel Screws plated to resist corrosion in most industrial applications

**AL-CU Tubular Screw**—Aluminum compatibility with aluminum or copper conductors. AL-CU is tin-plated brass.

**Environmental Contacts  
(for highly corrosive atmospheres)**

**Tubular Screw**—Electrical grade copper tube with nickel plating. Nickel plated brass screws.

**Strap Screw**—Nickel plated brass straps and screws. Nickel plating meets specification QQ-N-290A Class I, Grade G.

**Polyamide Material:**

**Housing Material**—Polyamide, Unfilled Type 6/6

**Max. Continuous Temperature**—125°C, (257°F)

**Breakdown Voltage (AC, 60 Hz)**—

Contact-to-Contact: 7000V

Contact-to-Ground: 10,000V

**Dielectric Strength (RH 40% at Sea Level)**—470-385 Volts/mil thickness Per ASTM D149

**UL High Voltage Arc Tracking (inches/min.)**—0.1-0.35 [25-8.89]

**Water Absorption (24 hrs. % wt. gain)**—1.5% per ASTM D570

**Flammability**—UL94V-2

**Chemical Resistance**—Resistant to aromatic hydrocarbons, strong alkalies per ASTM D543

**Radiation Resistance (ergs g-1 (C))**—8 x 107

**Color**—Translucent White

**Polypropylene Material:**

**Housing Material**—Polypropylene, Filled self-extinguishing

**Max. Continuous Temperature**—105°C, (221°F)

**Breakdown Voltage (AC, 60Hz)**—

Contact-to-Ground: 10,000V

Contact-to-Contact: 7000V

**Dielectric Strength (RH 40% at Sea Level)**—500 Volts/mil thickness per ASTM D149

**UL High Voltage Arc Tracking (inches/min.)**—Did not track

**Water Absorption (24 hrs. % wt. gain)**—0.02% Per ASTM D570

**Flammability**—UL94V-0

**Chemical Resistance**—Resistant to most acids, alkalines, and saline solutions. Also resistant to higher aliphatic solvents and polar substances per ASTM D543

**Radiation Resistance (ergs g-1 (C))**—No data Available

**Color**—Opaque White

**0300 Series, Fuse & Switch, Nylon and Polypropylene** (Continued)

**Mounting Channel**



Steel Channel	Break Away Steel	Pre-punched Aluminum Channel
<b>Part Number</b>		
9-1437381-1 9-1437381-8	9-1437381-2	9-1437381-9 1437382-2
<b>Catalog Number</b>		
60 63-BU	60-B-36	64 67
<b>Standard Length</b>		
6 feet 3 feet	3 feet	6 feet 3 feet

**Channel Clamps**



**Marking Accessories**

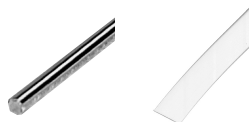

Screw Channel Clamps	Universal Clamps	Snap-In Clamps	Ganging Rod	Coated Cloth Marking tape
<b>Part Number</b>				
9-1437381-5	1437382-3	9-1437381-7	3-1437381-9	8-1437381-0
<b>Catalog Number</b>				
61	68	62	30	55-BU
<b>Standard Length</b>				
—	—	—	2 feet	50 feet

**Related Product Data**

**Wire Pins and Ferrules**—Pages 109-111  
 For more information on AMP Standard Terminals and Splices or Quick-Connect FASTON Receptacles and Tabs, request Catalog 82042.

**Note:** All part numbers are RoHS Compliant.

**0300 Series, Fuse & Switch, Nylon and Polypropylene (Continued)**

**Dovetail Base Mounted On Standard #60 Channel. May Also Be Mounted Direct**

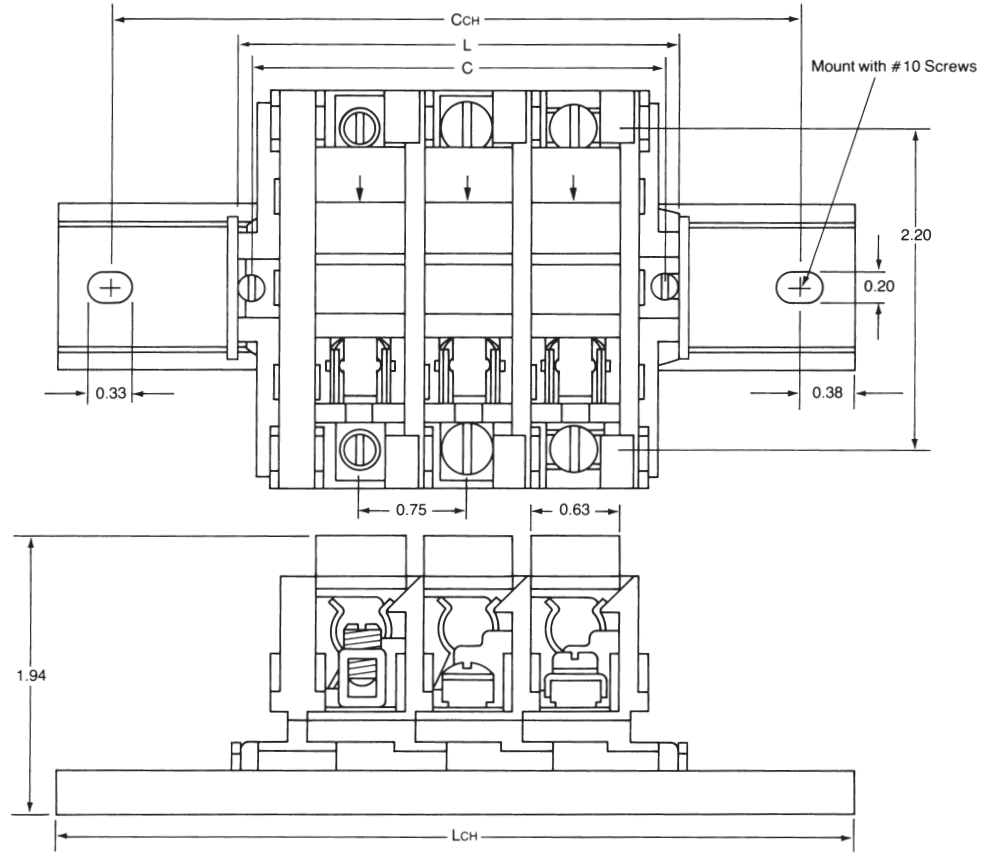

**CHANNEL MOUNTED**  
 $CCH = 2.28 + (.75 \times N)$   
 $LCH = 3.03 + (.75 \times N)$   
 N = Number of Circuits

**DIRECT MOUNTED**  
 $C = .56 + (.75 \times N)$   
 $L = .78 + (.75 \times N)$   
 N = Number of Circuits

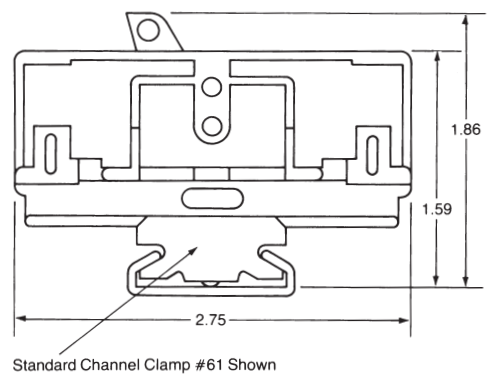

NEMA Terminal Blocks **6**

**Note:** All part numbers are RoHS Compliant.

### 300 Series, Fuse & Switch, Phenolic

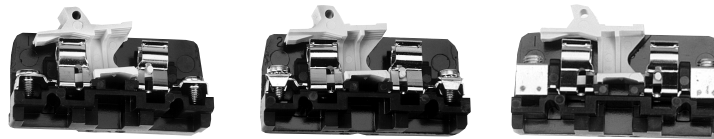

**Characteristics**

**Strap Screw**

**Strap Clamp**

**Tubular Screw**

Type of Block	Model	Part Number	Model	Part Number	Model	Part Number
<b>Direct Mount (Flat Base)</b>						
Fuse Block with Puller	351	2-1437397-8	358	3-1437397-1	352	3-1437397-0
Fuse Block without Puller	361	2-1437397-2	368-BU	3-1437397-5	362-BU	3-1437397-3
Switch Block	341	2-1437397-5	348	2-1437397-7	342	2-1437397-6
<b>Channel Mount (Dovetail Base)</b>						
Fuse Block with Puller	0351	1437397-9	0358	1-1437397-2	0352	1-1437397-0
Fuse Block without Puller	0361	1437397-4	0368	1-1437397-6	0362	1-1437397-5
Switch Block	0341	1437397-6	0348	1437397-8	0342	1437397-7

**Contact Type**



**Specifications**

Wire Range (AWG) Solid & Stranded	22-8	18-8	18-8
Wire Strip Length (in.)	—	1/2	1/2
Screw Type	8-32 binding head	8-32 pan head w/clamp	1/4"-28 set screw

**Ampacity**

Fuse Blocks	25A	25A	25A
Switch Blocks	15A	15A	15A

**End Sections**

No Contact, Flat Base	330-BU	2-14376397-4	330-BU	2-14376397-4	330-BU	2-14376397-4
No Contact, Dovetail Base	0330	14376397-5	0330	14376397-5	0330	14376397-5

**Comparison (Type of Block)**

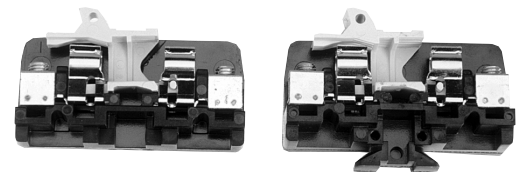

**Direct Mount  
(Flat Base)**

**Channel Mount  
(Dovetail Base)**

**Notes:** Standard package is 10 pieces.

For factory assembled blocks, suffix Catalog Number with number of blocks desired (Maximum number of flat base preassembled sections is 6).

EXAMPLE:

Twelve strap screw, fuse block sections preassembled on channel = 035112.

Six flat tubular screw, switch blocks preassembled without channel for direct mounting = 3426

For blocks with two or more different contact sections, preassembled with other blocks, imprinting or special features, consult Technical Support.

Environmental contacts for highly corrosive atmospheres are available with Nickel plating on non-ferrous hardware. To order, prefix Catalog Number with "D".

Except  
Switch  
Blocks



LR25557



E34934



**300 Series, Fuse & Switch, Phenolic—Accessories**

**Mounting Channel**



**Fuse Puller**

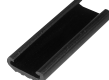

Steel Channel	Break Away Steel	Pre-punched Aluminum Channel	Fuse Puller	3-Gang Fuse Puller
<b>Part Number</b>				
9-1437381-1 9-1437381-8	9-1437381-2	9-1437381-9 1437382-2	2-1437397-1	2-1437397-2
<b>Catalog Number</b>				
60-BU 63-BU	60-B-36	64 67	31-BU	32
<b>Standard Length</b>				
6 feet 3 feet	3 feet	6 feet 3 feet	—	—

**Channel Clamps**



**Marking Accessories**

Screw Channel Clamps	Universal Clamps	Snap-In Clamps	Ganging Rod	Coated Cloth Marking Tape
<b>Part Number</b>				
9-1437381-5	1437382-3	9-1437381-7	3-1437381-9	8-1437381-0
<b>Catalog Number</b>				
61	68	62	30	55-BU
<b>Standard Length</b>				
—	—	—	2 feet	50 feet

**Physical Properties**

**Housing Material**—Phenolic, filled flame retardant  
**Color**—Black

**Contacts**

**Material**—Copper alloy spring clips. Steel screws plated to resist corrosion in most industrial applications

**Strap Screw**—11/32" max. lug width

**Mechanical Properties**

**Pitch (terminal spacing)**—0.75" [19.05]  
(16 circuits per foot)

**Switch Handles**

**Material**—Polypropylene

**Color**—White

**Electrical Properties**

**Operating Voltage**—Blocks meet 600V creepage and clearance requirements of NEMA, UL and CSA standards for general industrial control equipment and panelboards; withstand voltage exceeds IEEE switchgear standards for 750V

**Dielectric Strength (RH 40% @ sea level)**—300 volts/mil thickness per ASTM D149

**UL High Voltage Arc Tracking (inches/min.)**—.49-.58 [12.45-14.73]

**Fuse Size**—Any 13/32 x 1-1/2 in. [10.32 x 38.10] ferrule type cartridge fuse up to 25 amps, indicating or non-indicating, which meets Mil. Spec. F-15160, is recommended.

**Environmental Properties**

**Max. Service Temperature**—150°C (302°F)

**Water Absorption (24hrs. % wt. gain)**—0.45% per ASTM D570

**Flammability Rating**—UL94V-1

**Chemical Resistance**—Resistant to acids, alkalies, and aliphatic hydrocarbons and ketones, per ASTM D543

**Radiation Resistance (ergs g-1 (C))**—2.7 x 108

**UL Independent Testing Service Recognitions:**

**Wire Sizes**—Solid or Stranded, Tubular Screw Cat. # 362-BU, 0362

1 #4 AWG, 1 #6 AWG, 1 #8 AWG,  
1 to 4 #10 AWG, 1 to 5 #12 AWG, 1 to 6 #14 AWG, 1 to 6 #16 AWG, 1 to 8 #18 AWG

**Related Product Data**

**Wire Pins and Ferrules**—Pages 135-137

For more information on AMP Standard Terminals and Splices or Quick-Connect FASTON Receptacles and Tabs, request Catalog 82042.

Cat #'s  
31 and  
32



E63810

**Note:** All part numbers are RoHS Compliant.

**300 Series, Fuse & Switch, Phenolic, Flat Base**

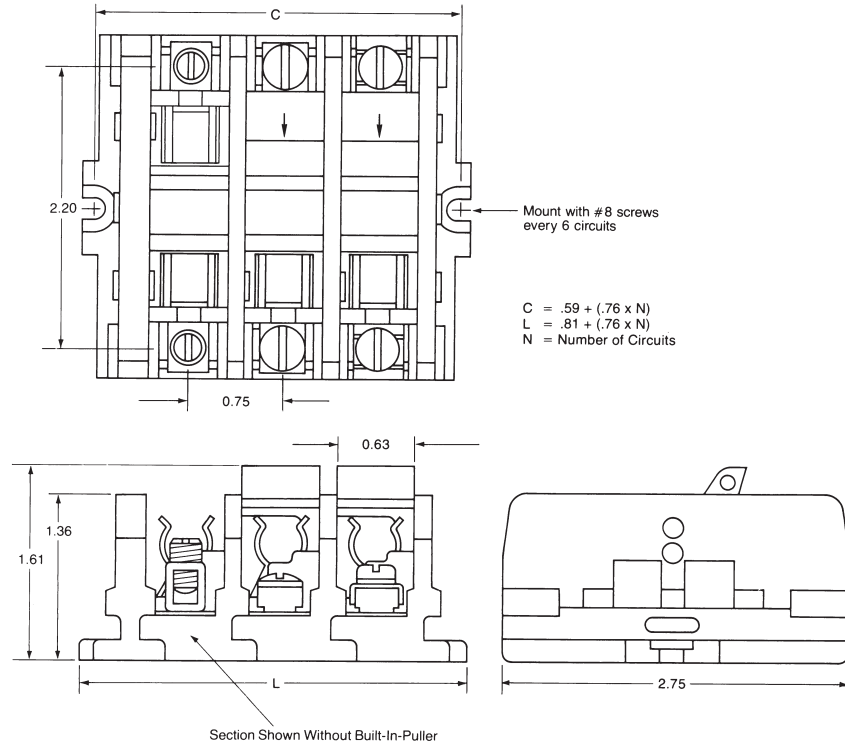

**Dovetail Base Mounted On Standard #60 Channel**

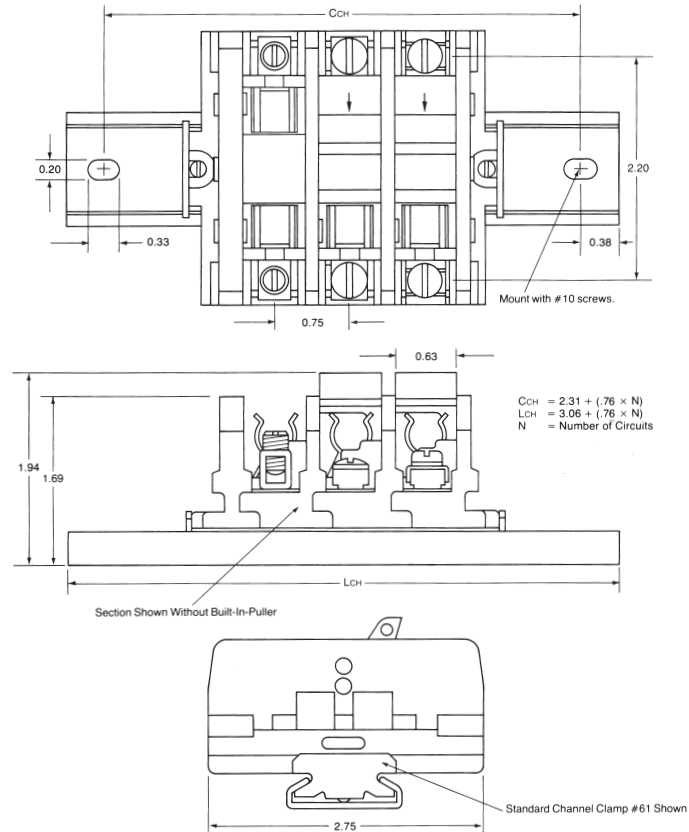

## One-Piece Phenolic Blocks

### Product Facts

- n Two, four, six, eight, and twelve circuit models available — 5/8" [15.88] center-to-center contact spacing.
- n No assembly required — each is a single, easily installed unit.
- n Three contact styles available — strap screw, captive strap clamp, and moving tubular contact.
- n Use wire up to #6 AWG with tubular contact. Strap screw and strap clamp contacts are available for #8 and smaller.
- n Withstand voltages in excess of IEEE standards for 750 volts. Meet clearance and creepage spacings specified in UL, CSA, and NEMA Industrial Control Standards for 600 Volts.
- n Strap contacts rated at 50 amperes — tubular contact conservatively rated at 70 amperes.
- n Pilot point screws supplied with strap screw and clamp contacts — speeds installation time.
- n Plain white marking strip supplied with each block — circuits are easily identified.
- n Special purpose blocks available—choose from blocks with solder posts, printed circuit board pins, or nuts on screw posts, removable circuit links, and a shorting bar.

Traditionally, these rugged One-Piece Blocks are the standard means of connection for heavy industrial applications like rail transport, utility, and traffic control industries. Ideal for dirty and vibration prone environments.

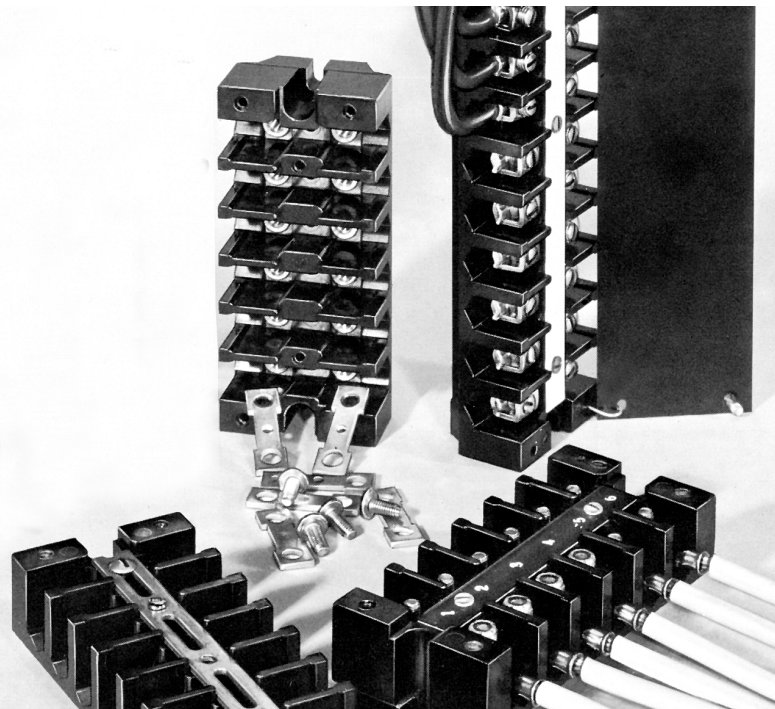

**B100, #B100 Series, One-Piece Blocks, 600 V — Phenolic**

**Material & Finish**

**Housing Material**—Phenolic, filled flame retardant

**Flammability**—UL94V-1

**Color**—Black

**Contacts**

**Standard Material**—Electrical grade copper or copper alloy conductor. Steel screws plated to resist corrosion in most industrial applications.

**Brass Material**—For Corrosive Environment (2B100, 4B100 Series) Nickel plated brass straps and screws. Meets specification QQ-N-290A Class 1, Grade G

**Wire Range**—Strap Screw: #18-8 AWG solid or stranded; Tubular Clamp: #14-6 AWG solid or stranded

**Screw Type**—Strap Screw: #10-32 Binding Head; Tubular Clamp: #1/4" [6.35]-28 Set Screw

**Strap Screw**—7/16" [11.11] max. lug width

**Mechanical Properties**

**Pitch (terminal spacing)**— .63" [16.00]

**Wire Strip Length**—Strap Screw: as needed for lugging; Tubular Clamp: 1/2" [12.1]

**Electrical Properties**

**Maximum Current**—70A for a single #6 AWG wire

**Operating Voltage**—Blocks meet 600V creepage and clearance requirements for general industrial control equipment and panelboards; greatly exceeds IEEE switchgear standards for 750 volts.

**Dielectric Strength (RH 40% @ sea level)**—300 Volts/mil thickness per ASTM D149

**UL High Voltage Arc Tracking (in./min.)**—.49-.58 [12.45-14.73]

**Environmental Properties**

**Max. Continuous Temperature**—150°C (302°F)

**Water Absorption (24hrs. % wt. gain)**—.45% per ASTM D570

**Chemical Resistance**—Resistant to acids, alkalis, and aliphatic hydrocarbons and ketones per ASTM D543

**Radiation Resistance (ergs G<sup>-1</sup> (C))**—2.7 x 10<sup>8</sup> min

**UL Independent Testing Service Recognitions**

**Wire Sizes**—Solid or Stranded, Tubular Clamp

1—#6 AWG, 1—#8 AWG, 1or 2—#10 AWG, 1or 2—#12 AWG, 1 to 3—#14 AWG, 1—#10 & 1—#12 AWG  
1—#12 & 1—#14 AWG

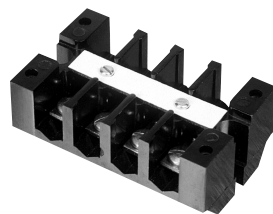

Circuits	Steel Screw w/Strap		Tubular Clamp		Brass Screw w/Strap	
	Part Number	Catalog Number	Part Number	Catalog Number	Part Number	Catalog Number
<b>Contact Type</b>						
<b>AMPACITY</b>						
	50A		65A		50A	
<b>Standard</b>						
2	2-1437382-6	B102	2-1437382-8	B102S	2-1437381-0	2B102
4	3-1437382-0	B104	3-1437382-6	B104S	2-1437381-2	2B104
6	4-1437382-0	B106-BU	4-1437382-5	B106S	2-1437381-6	2B106
8	4-1437382-9	B108	5-1437382-5	B108S	3-1437381-0	2B108
12	5-1437382-9	B112-BU	6-1437382-7	B112S	3-1437381-3	2B112
<b>Shorting*</b>						
2	4-1437381-0	3B102P	—	—	5-1437381-6	4B102P
4	4-1437381-1	3B104P	—	—	5-1437381-7	4B104P
6	4-1437381-3	3B106P	—	—	5-1437381-8	4B106P
8	4-1437381-5	3B108P	—	—	5-1437381-9	4B108P
12	4-1437381-7	3B112P	—	—	6-1437381-0	4B112P

Circuits	Strap Screw #8 & Smaller		Threaded Post & Nut	
<b>Removable Link</b>				
2	8-1437381-4	5B102	—	—
4	8-1437381-5	5B104	—	—
6	8-1437381-7	5B106	—	—
8	8-1437381-8	5B108	—	—
12	9-1437381-0	5B112	—	—
<b>Stud, #10-32</b>				
2	—	—	1-1437382-8	7B102
4	—	—	2-1437382-0	7B104
6	—	—	2-1437382-1	7B106
8	—	—	2-1437382-2	7B108
12	—	—	2-1437382-3	7B112

**Notes:**

For prenumbered marking strip, add suffix "N" to Catalog Number. Cannot be used on 3B or 4B series.

For factory assembled hinged cover, add suffix "H" to Catalog Number. Cannot be used on 3B or 4B series.

For factory assembled thumbscrew-fastened cover, add suffix "T" to Catalog Number. Cannot be used on 3B or 4B series.

Screws and removable links shipped unassembled.

\*Shorting blocks are supplied with 2 shorting screws each.

Except for 3B and 4B Series



**Note:** All part numbers are RoHS Compliant.

**B100, #B100 Series, One-Piece Blocks, 600 V — Phenolic Accessories**

**Covers and Marking**



Circuits	Laminated Phenolic Cover		Shorting Block Cover		White Marking Strip		Numbered Marking Strip	
	Part Number	Catalog Number	Part Number	Catalog Number	Part Number	Catalog Number	Part Number	Catalog Number
2	7-1437382-5	C102-BU	9-1437382-2	CS102	1-1437383-5	S102	1776733-2	N102
4	7-1437382-6	C104-BU	9-1437382-3	CS104	1-1437383-6	S104	1-1437383-1	N104
6	7-1437382-7	C106-BU	9-1437382-4	CS106	1-1437383-7	S106	1-1437383-2	N106
8	7-1437382-8	C108-BU	9-1437382-5	CS108	1-1437383-8	S108	1-1437383-3	N108
12	7-1437382-9	C112-BU	9-1437382-6	CS112	1-1437383-9	S112	1-1437383-4	N112

**Jumpers**



**Hardware**



Circuits	30A Copper Jumpers		50A 12 Circuit Jumpers		Connecting Link		Lock Nuts		Shorting Screw	
	Part No.	Catalog No.	Part No.	Catalog No.	Part No.	Catalog No.	Part No.	Catalog No.	Part No.	Catalog No.
2	1437383-2	J102	—	—	—	—	—	—	—	—
4	1437383-3	J104	—	—	—	—	—	—	—	—
6	1437383-4	J106	—	—	—	—	—	—	—	—
8	1437383-5	J108	—	—	—	—	—	—	—	—
12	1437383-6	J112	1437395-9	HJ112	—	—	—	—	—	—
<b>Hardware</b>										
—	—	—	—	—	9-1437382-0	CL101	1437383-7	LN101-BU	7-1437381-7	51-BU

**Related Product Data**

**Wire Pins and Ferrules**—Pages 109-111  
 For more information on AMP Standard Terminals and Splices or Quick-Connect FASTON Receptacles and Tabs, request Catalog 82042.



**Note:** All part numbers are RoHS Compliant.

**B100, #B100 Series, One-Piece Blocks, 600 V — Phenolic**

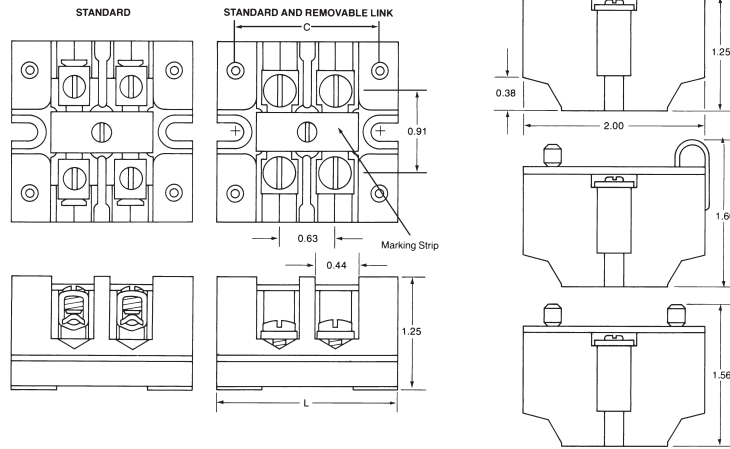

No. of Ckts.	C	L
2	1.63	2.00
4	2.88	3.25
6	4.13	4.50
8	5.38	5.75
12	7.88	8.25

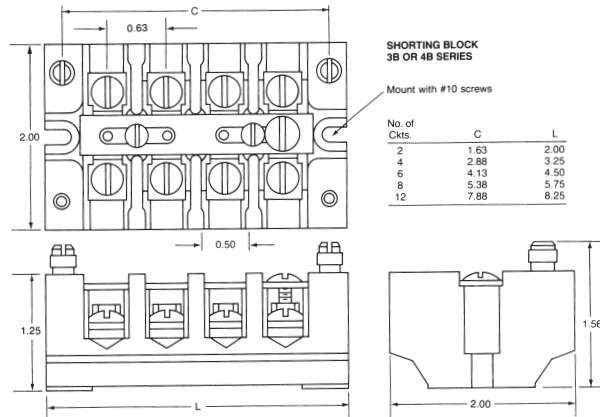

**SHORTING BLOCK  
3B OR 4B SERIES**

Mount with #10 screws

No. of Ckts.	C	L
2	1.63	2.00
4	2.88	3.25
6	4.13	4.50
8	5.38	5.75
12	7.88	8.25

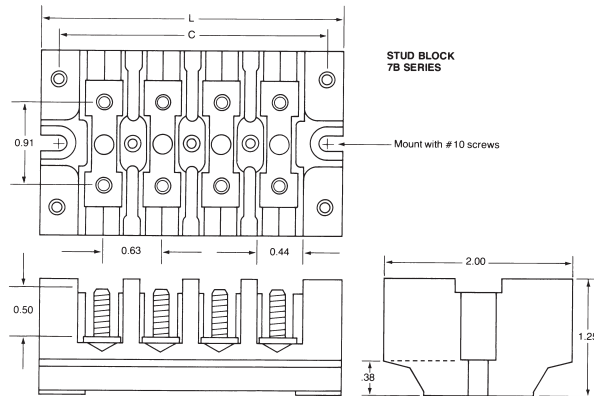

**STUD BLOCK  
7B SERIES**

Mount with #10 screws

**Note:** All part numbers are RoHS Compliant.

## Pre-Printed Marking Strips

Circuit identification is greatly simplified with the use of pre-printed strips for BUCHANAN terminal blocks. These hot-stamped strips are available for all snap-assembled sections (except Fuse, Switch, and Circuit Breaker models which are marked individually). The strips can be ordered separately or pre-installed on factory assembled sectional block units.

Unlike painted or screened letters, hot-stamped letters are designed to not rub or flake off during industrial use so that they will retain their legibility.

Marking strips are stamped with consecutive numbers that can be ordered to read from left-to-right or right-to-left, and in vertical or horizontal positions. Number sequences can begin with any number. This allows circuits to be identified in a manner most consistent with the terminal block application.

**M 50 005 13 G**

**A B C D E**

- A M = Hot-Stamped Marking Strip**
- B Terminal Block Series and Designator**  
 10 = Miniature or Single Tier  
 12 = Double Tier  
 67 = 900 Series Medium Duty  
 24 = Nylon Heavy Duty  
 21 = Phenolic Heavy Duty  
 80 = Intermediate Heavy Duty  
 40 = Ultra Heavy Duty  
 T2 = TSB230  
 T5 = TSB500  
 T6 = TSB1000  
 T7 = TSB2000
- C Number of Circuits to be Consecutively Numbered**  
 (Use three digits: Ex.: 005 = 5, 055 = 55, etc.)
- D Marking Style Options**  
 11 = 1 2 3 4 5...  
 12 = ...5 4 3 2 1  
 13 = ... 1 2 3 4 5...  
 14 = ... 5 4 3 2 1
- E "First Number In Series" Designator\***  

A = 1	F = 6
B = 2	G = 7
C = 3	H = 8
D = 4	J = 9
E = 5	K = 0

### Marking Strip Installed On A Factory-Assembled Terminal Block

**615 005 11 A**

**A B C D**

- A Basic Sectional Block Catalog #**
- B Number of Circuits to be Factory Assembled and Consecutively Numbered**  
 (Use three digits: Ex: 005 = 5, 055 = 55, etc.)
- C Marking Style Options**  
 11 = 1 2 3 4 5...  
 12 = ...5 4 3 2 1  
 13 = ... 1 2 3 4 5...  
 14 = ... 5 4 3 2 1
- D "First Number In Series" Designator\***  

A = 1	F = 6
B = 2	G = 7
C = 3	H = 8
D = 4	J = 9
E = 5	K = 0

\* Letters in this position designate the first number to be used in the consecutive sequence. Ex.: "A" would start the sequence with the number 1. "EK" would start the sequence with the number 50. "BKK" would start the series with 200. For non-sequential numbering and special characters, consult Technical Support.

## Technical Summary

Cat. No.	Terminal Block or Product Line	Contact Type Material Plate	Screw		Material & Plating	Recommended Screwdriver Dimensions		Wire Strip Length	Wire Range AWG	Rec. Torque in. - lb.
			Screw Style	Slot Size		Tip Thick	Tip Width			
105-BU 115 125-BU	High Density Tubular Clamp	Electroplated Tubular Copper Contact	6-32 Slotted Screw	033" Wide x .040" Deep [1.84 x 1.02] Steel	Steel Electroplated	.020" [.51]	9/64" [.02]	5/16" [7.94]	#12-30	10
211 241	HeavyDuty Strap Screw	Copper Alloy Strap Electroplated	Binding Head 10-32 Thread	062" Wide x 062" Deep [1.57 x 1.57]	"	.037" [.94]	1/4" [6.35]	As Needed for Lugging	#8 or Smaller	12
212 222-BU 242	Heavy Duty Tubular Screw	Electroplated Tubular Copper Contact	Headless 1/4"-28 Thd. Slotted	3/64" Wide x 1/16" Deep [1.19 x 1.59]	"	"	"	1/2" [12.7]	#4-18	35
213 243	Heavy Duty Tubular Clamp	"	"	"	"	"	"	"	#6-18	35
218 248	Heavy Duty Strap Clamp	Copper Alloy Strap Electroplated	Pan Head Saddle Clamp 8-32 Thd.	3/64" Wide x 3/64" Deep [1.19 x 1.19]	"	"	"	"	#8-18	12
351 361 0311	Fuse Block Strap Screw	Copper Alloy Electroplated Spring Temper	Binding Head 8-32 Thd.	"	"	"	"	As Needed for Lugging	#8 or Smaller	10
358 368 318	Fuse Block Strap Clamp	"	Pan Head w/SaddleClp. 8-32 Thd.	"	"	"	"	1/2" [12.7]	#8-18	"
352 362-BU 312	Fuse Block Tubular Screw	Same as above except use H.D. Tubular Contact	Headless 1/4"-28 Thd. slotted	"	"	"	"	"	"	"
341 371 342	Switch Block Strap Screw	CopperAlloy Electroplated Spring Temper	"	"	"	"	"	As Needed for Lugging	#8 or Smaller	"
348 0378	Switch Block Strap Clamp	"	Pan Head w/SaddleClp 8-32 Thd.	"	"	"	"	1/2" [12.7]	#8-18	"
342 0372	Switch Block Tubular Screw	Same as above except use H D. Tubular Contact	"	"	"	"	"	"	"	"
416 426-BU	Extra Heavy Duty Tubular Screw	Electroplated-Tubular Copper Contact	1/2"-13 Hex Socket Hd. Set Screw	1/4" [6.35] Hex	"	1/2" [12.7] Hex	T-Bar Key	7/8" [22.23]	#12-2/0	200

**Note:** Representative Catalog Numbers Listed.



### Technical Summary (Continued)

Cat. No.	Terminal Block or Product Line	Contact Type Material plate	Screw		Material & Plating	Recommended Screwdriver Dimensions		Wire Strip Length	Wire Range AWG	Rec. Torque in. - lb.
			Screw Style	Slot Size		Tip Thick	Tip Width			
417	Extra HD	Electroplated	3/4"-16 Hex Socket Head Set Screw	3/8" Hex [9.53]	Steel Electroplated	3/8" Hex [9.53]	KeyT-Bar	1" [25.4]	#6-250	375 kcmil (MCM)
427-BU	Tubular Screw	Tubular Copper Contact								
517 617 717	Medium Duty Quick-Connect	1/4" Wide QC .032" Thk Copper Alloy Electroplated	N/A	N/A	N/A	N/A	N/A	N/A	N/A	N/A
1546235-1	Medium Duty Tubular Clamp	Electroplated Tubular Copper Contact	10-32 Slotted Hd	.046" Wide x .046" Deep [1.17 x 1.17]	Steel Electroplated	.032" [.81]	3/16" [4.76]	11/32" [8.73]	#10-22	8
1546152-1	Medium Duty QC & Tubular Screw	1/4" Wide QC .032" Thk. Tubular Contact Both Copper Alloy Electroplated	"	"	"	"	"	"	#8-18	10
1546148-1	Medium Duty Tubular Screw	Electroplated Tubular Copper Contact	"	"	"	"	"	"		8
1546143-1	Medium Duty Strap Screw	Copper Alloy Strap Electroplated	6-32 Thd. Slotted Binding Hd.	3/64" Wide x 3/64" Deep [1.19 x 1.19]	"	"	"	As Needed for Lugging	#8 or Smaller	12
824-BU	Intermediate Tubular Screw	Electroplated Tubular Copper Contact	7/16"-20Thd. Slotted Headless	5/64" Wide x 5/64" Deep [1.98 x 1.98]	"	.041" [1.04]	3/8" [9.53]	11/16" [17.46]	#12-1/0	50
B102 B112-BU	One-Piece Blk. Strap Screw	Copper Alloy Strap Electroplated	10-32 Thd. Slotted Binding Hd.	1/16" Wide x 1/16" Deep [1.59 x 1.59]	"	.037" [.94]	1/4" [6.35]	As Needed for Lugging	#8 or Smaller	20
B102S B112S	One-Piece Blk. Tubular Contact	Tubular Contact	1/4" -28 Thd. Headless Set Screw	3/64" Wide x 3/64" Deep [1.19 x 1.19]	"	"	"	1/2" [12.7]	#6-14	45

**Note:** Representative Catalog Numbers Listed.

## UL 1059 Basic Voltage Rating

Voltage ratings of terminal blocks are based on the minimum spacing between electrical conductive parts of opposite polarity or between an electrically conductive part and a metal mounting surface measured under two conditions: Through Air, defined as the distance an arc must take through the air to go from one live conductor to another or from a live conductor to ground; and Over Surface, defined as the distance an arc must take over a surface of the insulating material going from one terminal to ground, assuming the arc will travel along the surface rather than through the air. The following chart shows UL 1059 spacing requirements in inches.

### Voltage Rating

Description	Voltage	Spacing Requirements	
		Thru Air	Over Surface
Class A Service equipment including deadfront switchboards, panel boards, service entrance devices, etc.	51 - 150 151 - 300 251 - 600	1/2 [12.7] 3/4 [19.05] 1 [25.4]	3/4 [19.05] 1 1/4 [31.75] 2 [50.8]
Class B Commercial appliances including business equipment, electronic data processing equipment and the like	51 - 150 151 - 300 251 - 600	1/16 [1.59] 3/32 [2.38] 3/8 [9.53]	1/16 [1.59] 3/32 [2.38] 1/2 [12.7]
Class C General industrial and machine tools; controls which can be further defined as equipment falling under UL508	51 - 150 151 - 300 301 - 600	1/8 [3.18] 1/4 [6.35] 3/8 [9.53]	1/4 [6.35] 3/8 [9.53] 1/2 [12.7]
Devices having limited ratings <sup>a</sup>	51 - 300 301 - 600	1/16 [1.59] 3/16 [4.76]	1/8 [3.18] 3/8 [9.53]

<sup>a</sup>Load on any single circuit can not exceed 15 A at 51-150 V, 10 A at 151-300 V, 5 A at 301-600 V or the maximum current rating, whichever is less.

### Standard Test Criteria

Test	Per:
Heat Cycling (term)	UL486E Section 10
Static Heating (term)	UL486E Section 11
Secureness	UL486E Section 12
Pullout	UL486E Section 14
Heating Test (block)	UL1059 Section 10
Dielectric Withstand	UL1059 Section 11
Strength of Base	UL1059 Section 13
Tab Pull	UL1059 Section 14
VPTA	UL1059 Section 15
Salt Spray	MIL-202 Method 101
Solderability	MIL-202 Method 208
Solvents	MIL-202 Method 215