

Pushbutton Switches, Tiny, Process Sealed, Straight

SEE PAGE D6 FOR PRODUCT SPECIFICATIONS

* Refer to Page D6 for Additional Options *

SPST/SPDT



TPB11CGPCES



TPC11CGPCES

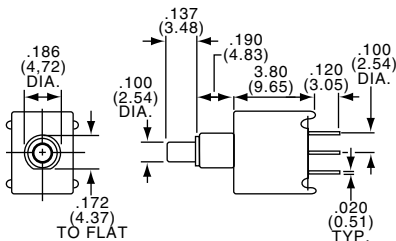

TPB SERIES

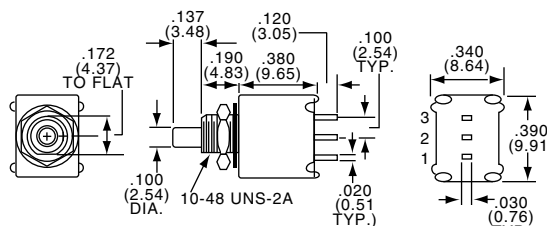

TPC SERIES

Model	Type	Act. Code	P. M6	Action	Bushing Dia.	Contact Type
TPB11CGPCES(*)	SPST	C		N.O. Momentary	.188	Gold
TPB11FGPCES(*)	SPDT	F		Momentary	.188	Gold
TPC11CGPCES(*)	SPST	C		N.O. Momentary	10-48	Gold
TPC11FGPCES(*)	SPDT	F		Momentary	10-48	Gold

(*) Specify button color by adding suffix number: (0) Black, (2) Red.
Note: No center terminal on "C" action switch.

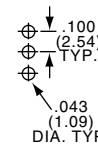

DPST/DPDT



TPB21RGPCEs

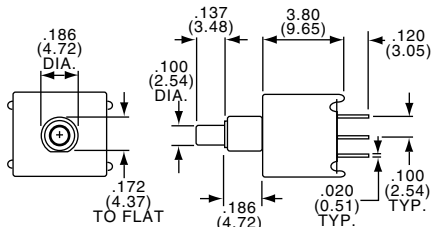

TPB SERIES

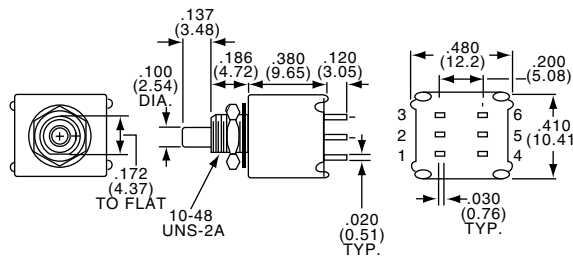

TPC SERIES

Model	Type	Act. Code	P. M6	Action	Bushing Dia.	Contact Type
TPB21MGPCEs(*)	DPST	M		N.O. Momentary	.188	Gold
TPB21RGPCEs(*)	DPDT	R		Momentary	.188	Gold
TPC21MGPCEs(*)	DPST	M		N.O. Momentary	10-48	Gold
TPC21RGPCEs(*)	DPDT	R		Momentary	10-48	Gold

(*) Specify button color by adding suffix number: (0) Black, (2) Red.
Note: No center terminal on "M" action switch.

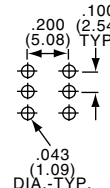

SPST/SPDT



TPD11CGPCES



TPF11CGPCES

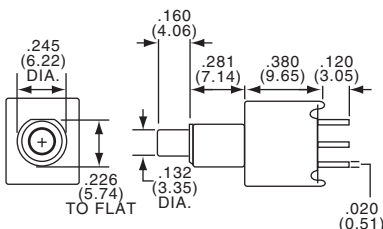

TPD SERIES

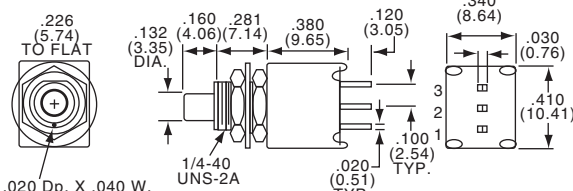

TPF SERIES

Model	Type	Act. Code	P. M6	Action	Bushing Dia.	Contact Type
TPD11CGPCES(*)	SPST	C		N.O. Momentary	.250	Gold
TPD11FGPCES(*)	SPDT	D		Momentary	.250	Gold
TPF11CGPCES(*)	SPST	C		N.O. Momentary	.250	Gold
TPF11FGPCES(*)	SPDT	F		Momentary	.250	Gold

(*) Specify button color by adding suffix number: (0) Black, (2) Red.
Note: No center terminal on "C" action switch.

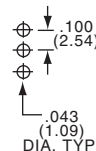

Pushbutton Switches, Tiny, Process Sealed, Straight or Right Angle

SEE PAGE D6 FOR PRODUCT SPECIFICATIONS

DPST/DPDT

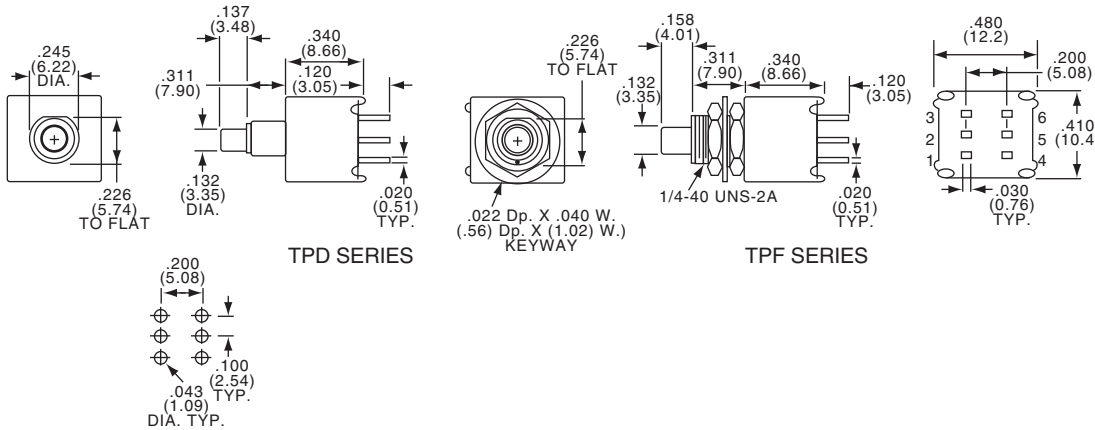

TPD21MGPCES

Model	Type	Act. Code	P. M6	Action	Bushing Dia.	Contact Type
TPD21MGPCES(*)	DPST	M		N.O. Momentary	.250	Gold
TPD21RGPCES(*)	DPDT	R		Momentary	.250	Gold
TPF21MGPCES(*)	DPST	M		N.O. Momentary	1/4-40	Gold
TPF21RGPCES(*)	DPDT	R		Momentary	1/4-40	Gold

(*) Specify button color by adding suffix number: (0) Black, (2) Red.
Note: No center terminal on "M" action switch.

SPST/SPDT

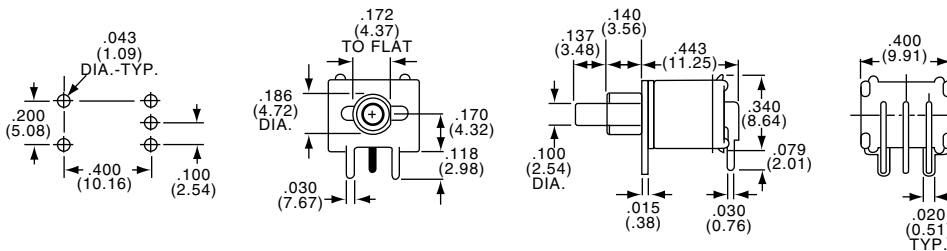

TPB11CGRAES

Model	Type	Act. Code	P. M6	Action	Bushing Dia.	Contact Type
TPB11CGRAES(*)	SPST	C		N.O. Momentary	.188	Gold
TPB11FGRAES(*)	SPDT	F		Momentary	.188	Gold

(*) Specify button color by adding suffix number: (0) Black, (2) Red.
Note: No center terminal on "C" action switch.

DPST/DPDT

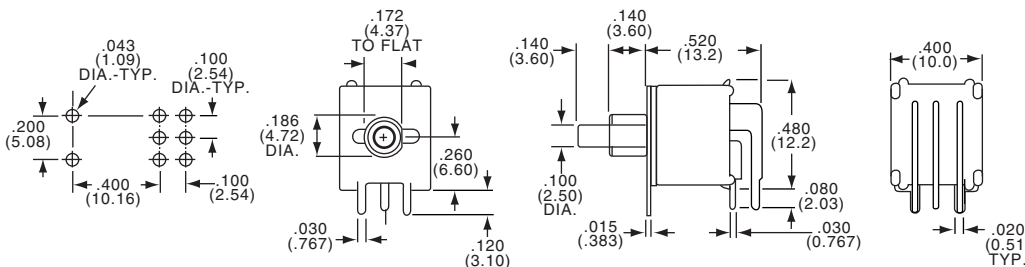

Model	Type	Act. Code	P. M6	Action	Bushing Dia.	Contact Type
TPB21MGRRAES(*)	DPST	M		N.O. Momentary	.188	Gold
TPB21RGRRAES(*)	DPDT	R		Momentary	.188	Gold

(*) Specify button color by adding suffix number: (0) Black, (2) Red.
Note: No center terminal on "M" action switch.

Pushbutton Switches, Tiny, Process Sealed, Flush Actuator, Straight or Right Angle

SEE PAGE D6 FOR PRODUCT SPECIFICATIONS

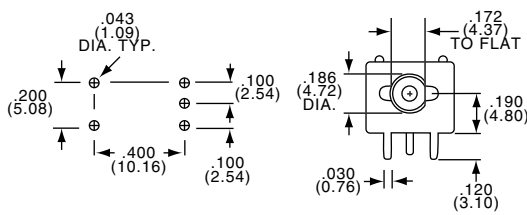

TPBF Series

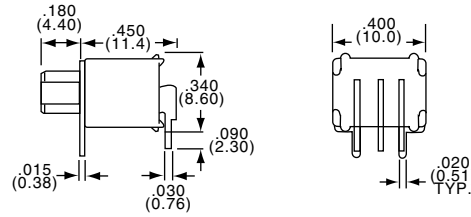

SPST/SPDT



TPBF11CGRAESO

Model	Type	Act. Code P. M6	Action
TPBF11CGRAES(*)	SPST	C	N.O. Momentary
TPBF11FGRAES(*)	SPDT	F	Momentary

(*) Specify button color by adding suffix numbers: (0) Black, (2) Red.

Note: No center terminal on "C" Action switches.

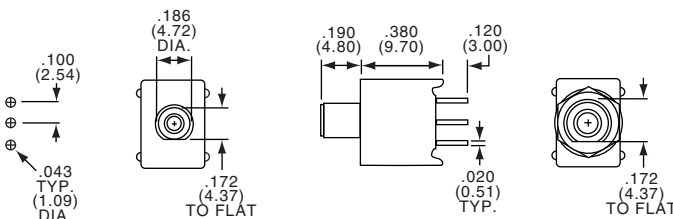

TPBF Series

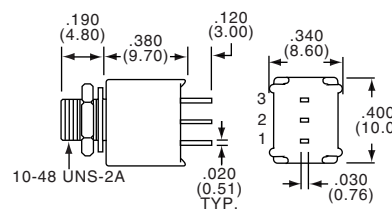

TPCF Series

SPST/SPDT



TPBF11CGPCES

Model	Type	Act. Code P. M6	Action
TPBF11CGPCES(*)	SPST	C	N.O. Momentary
TPBF11FGPCES(*)	SPDT	F	Momentary
TPCF11FGPCES(*)	SPDT	F	Momentary

(*) Specify button color by adding suffix numbers: (0) Black, (2) Red.
Note: No center terminal on "C" action switch.