



Pushbutton Switches, Tiny, Part Number Matrix

MATERIAL SPECIFICATIONS:

ContactsGold - gold plate, silver - silver plate
Case MaterialHigh temperature polyester
Actuator Material.....Polyamide
Terminals/Fixed ContactsTin lead plate
Terminal Seal.....SP epoxy, DP epoxy optional

TYPICAL PERFORMANCE CHARACTERISTICS:

Contact RatingGold: 0.4 VA Max. @ 20 VDC or peak AC
Silver: 1A @ 125 VAC or 28 VDC resistive
Initial Contact Resistance20 Milliohms max.
Contact TimingBreak-before-make
Insulation Resistance1,000 Megohms @ 500VDC min.
Dielectric Strength.....1,000 Volts @ sea level
Actuation Force50 to 400 Grams
Plunger/Actuator Travel030" (.762)
Life ExpectancySee below
Note: Hardware included with switches

ENVIRONMENTAL SPECIFICATIONS:

Operating Temperature-22°F to +149°F (-30°C to +65°C)
Storage Temperature-22°F to +149°F (-30°C to +65°C)
Solder Heat ResistanceSee page M3-4

PART NUMBERING MATRIX

TP Series

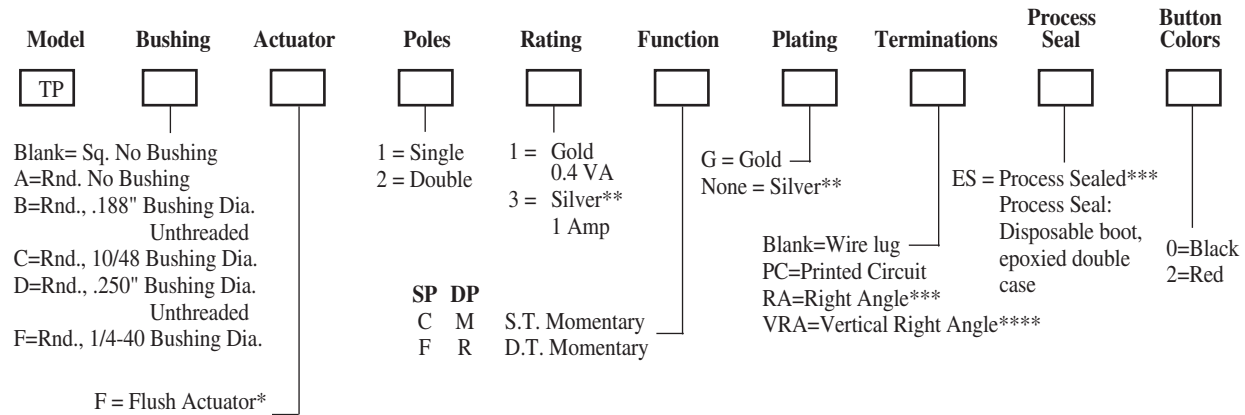

- * Available with "B" and "C" bushing only
- ** Silver - available only in wire lug and PC termination
- *** Right angle, ES available with "B" and "C" bushing only
- **** Available only in single pole

ES switches provided with disposable boot used only during cleaning operation.

Application Note:

For 3 pole and 4 pole, refer to pages D22 and D24 . . . "MP Series"
For Surface Mount termination, refer to pages D3-D5 . . . "TSP Series"

Pushbuttons	1 Pole	2 Pole
0.4 (Gold Plate)	100,000	80,000
1A (Silver Plate)	60,000	50,000

PROCESS SEAL VERSION NOT



TP



TPA

PROCESS SEAL VERSION AVAILABLE



TPB



TPC



TPD



TPF

SERIES (TP)

Pushbutton Switches, Tiny, Straight or Right Angle, Single or Dual Actuators

SEE PAGE D6 FOR PRODUCT SPECIFICATIONS

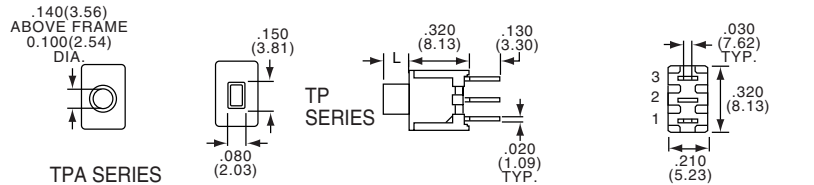

SPST/SPDT



TP11CGPC0



TPA11CGPC0

Model	Actuator Type	Dim.L	Type	Act. Code	P. M6	Action	Contact Type
TP11CGPC(*)	SQ.	.125	SPST	C		N.O. Momentary	Gold
TP11FGPC(*)	SQ.	.125	SPDT	F		Momentary	Gold
TPA11CGPC(*)	RND.	.150	SPST	C		N.O. Momentary	Gold
TPA11FGPC(*)	RND.	.150	SPDT	F		Momentary	Gold

(*) Specify button color by adding suffix number: (0) Black, (2) Red.
Note: No center terminal on "C" action switch.

D
TP/TPA Series

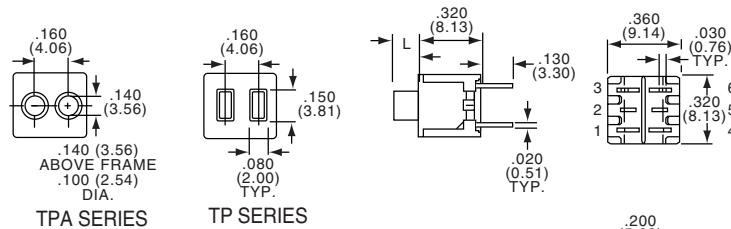

SPST/SPDT (DUAL)



TP21CCGPC0

Model	Actuator Type	Dim.L	Type	Act. Code	P. M6	Action	Contact Type
TP21CCGPC(*)	SQ.	.125	2xSPST	C		N.O. Momentary	Gold
TPA21CCGPC(*)	RND.	.150	2xSPST	C		N.O. Momentary	Gold
TPA21FFGPC(*)	RND.	.150	2xSPDT	F		Momentary	Gold

(*) Specify button color by adding suffix number: (0) Black, (2) Red.
Note: No center terminal on "C" action switch.

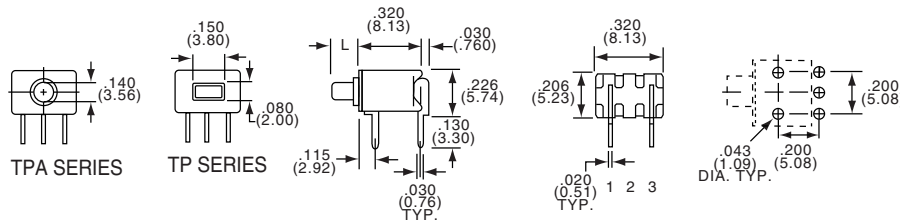
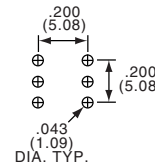

SPST/SPDT



TPA11CGRA



TP11CGRA

Model	Actuator Type	Dim.L	Type	Act. Code	P. M6	Action	Contact Type
TP11CGRA(*)	SQ.	.125	SPST	C		N.O. Momentary	Gold
TP11FGRA(*)	SQ.	.125	SPDT	F		Momentary	Gold
TPA11CGRA(*)	RND.	.150	SPST	C		N.O. Momentary	Gold
TPA11FGRA(*)	RND.	.150	SPDT	F		Momentary	Gold

(*) Specify button color by adding suffix number: (0) Black, (2) Red.
Note: No center terminal on "C" action switch.

Pushbutton Switches, Tiny, Right Angle, Single or Dual Actuators

SEE PAGE D6 FOR PRODUCT SPECIFICATIONS

* Refer to Page D6 for Additional Options *
TP/TPA Series



TP21CCGRA0

SPST/SPDT (DUAL)
DPST

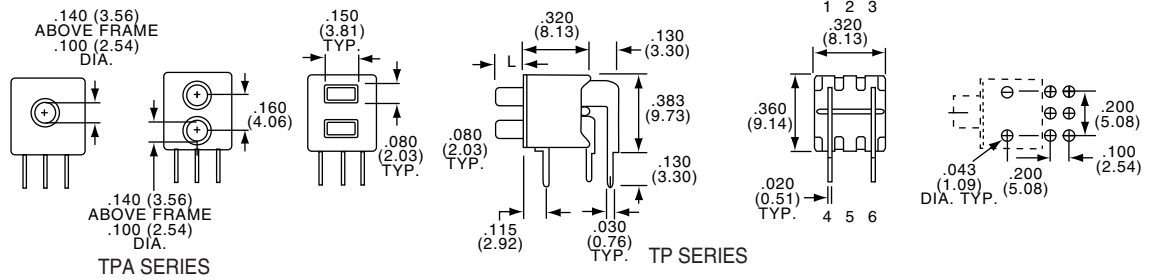

Model	Actuator Type	Dim.L	Type	Act. Code P. M6	Action	Contact Type
TP21CCGRA(*)	SQ.	.125	2xSPST	C	N.O. Momentary	Gold
TP21FFGRA(*)	SQ.	.125	2xSPDT	F	Momentary	Gold
TPA21MGRA(*)	RND.	.150	DPST	M	N.O. Momentary	Gold
TPA21CCGRA(*)	RND.	.150	2xSPST	C	N.O. Momentary	Gold
TPA21FFGRA(*)	RND.	.150	2xSPDT	F	Momentary	Gold

(*) Specify button color by adding suffix number: (0) Black, (2) Red.
Note: No center terminal on "C" or "M" action switch.

Pushbutton Switches, Tiny, Straight or Right Angle, Unthreaded or 10-48 Bushing

SPST/SPDT



TPB11CGPC



TPC11FGPC

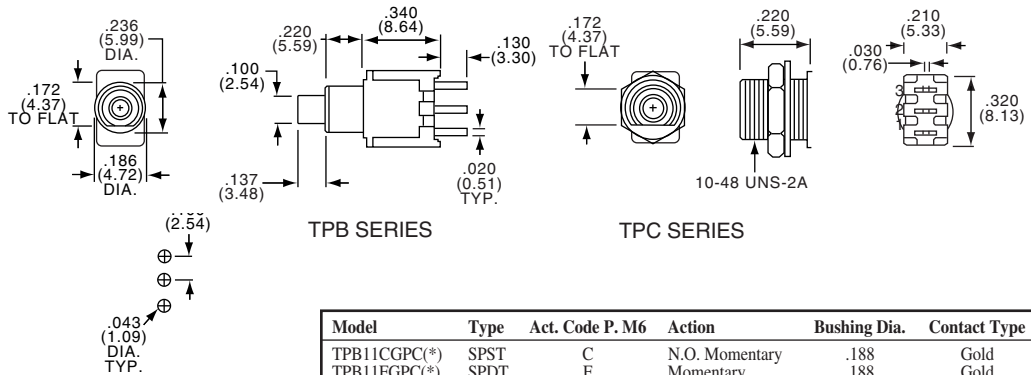

Model	Type	Act. Code P. M6	Action	Bushing Dia.	Contact Type
TPB11CGPC(*)	SPST	C	N.O. Momentary	.188	Gold
TPB11FGPC(*)	SPDT	F	Momentary	.188	Gold
TPC11CGPC(*)	SPST	C	N.O. Momentary	10-48	Gold
TPC11FGPC(*)	SPDT	F	Momentary	10-48	Gold

(*) Specify button color by adding suffix number: (0) Black, (2) Red.
Note: No center terminal on "C" action switch.

DPST/DPDT



TPB11CGRA



TPC11CGRA

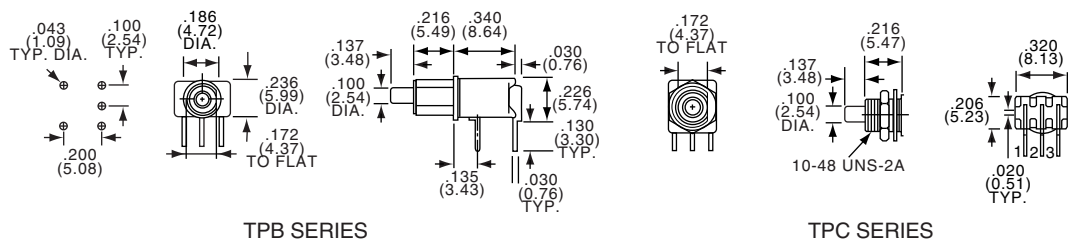

Model	Type	Act. Code P. M6	Action	Bushing Dia.	Contact Type
TPB11CGRA(*)	SPST	C	N.O. Momentary	.188	Gold
TPB11FGRA(*)	SPDT	F	Momentary	.188	Gold
TPC11CGRA(*)	SPST	C	N.O. Momentary	10-48	Gold
TPC11FGRA(*)	SPDT	F	Momentary	10-48	Gold

(*) Specify button color by adding suffix number: (0) Black, (2) Red.
Note: No center terminal on "C" action switch.

Pushbutton Switches, Tiny, Straight or Right Angle, Unthreaded or 10-48 Bushing

SEE PAGE D6 FOR PRODUCT SPECIFICATIONS
DPST/DPDT

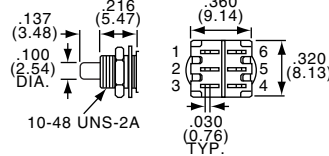
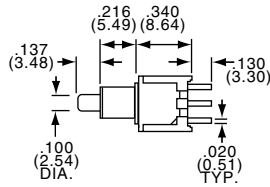
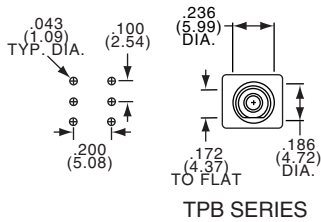

TPB21MGPC



TPC21RGPC

Model	Type	Act. Code P. M6	Action	Bushing Dia.	Contact Type
TPB21MGPC(*)	DPST	M	N.O. Momentary	.188	Gold
TPB21RGPC(*)	DPDT	R	Momentary	.188	Gold
TPC21MGPC(*)	DPST	M	N.O. Momentary	10-48	Gold
TPC21RGPC(*)	DPDT	R	Momentary	10-48	Gold

(*) Specify button color by adding suffix number: (0) Black, (2) Red.
Note: No center terminal on "M" action switch.

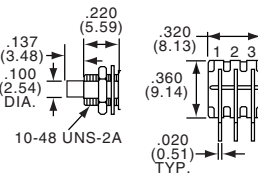
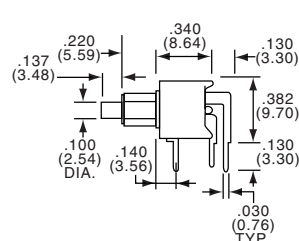
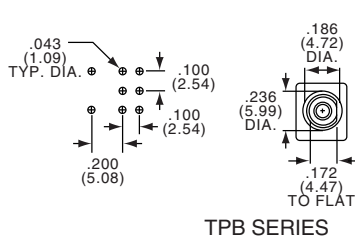

DPST/DPDT



TPC21MGRA

Model	Type	Act. Code P. M6	Action	Bushing Dia.	Contact Type
TPB21MGRA(*)	DPST	M	N.O. Momentary	.188	Gold
TPB21RGRA(*)	DPDT	R	Momentary	.188	Gold
TPC21MGRA(*)	DPST	M	N.O. Momentary	10-48	Gold
TPC21RGRA(*)	DPDT	R	Momentary	10-48	Gold

(*) Specify button color by adding suffix number: (0) Black, (2) Red.
Note: No center terminal on "M" action switch.

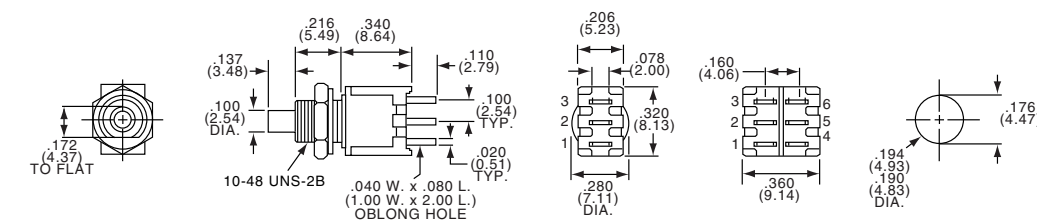

1 & 2 POLE



TPC23M



TPC13C

Model	Type	Act. Code P. M6	Action	Contact Type
TPC13C(*)	SPST	C	N.O. Momentary	Silver
TPC13F(*)	SPDT	F	Momentary	Silver
TPC23M(*)	DPST	M	N.O. Momentary	Silver
TPC23R(*)	DPDT	R	Momentary	Silver

(*) Specify button color by adding suffix number: (0) Black, (2) Red.
Note: No center terminal on "C" or "M" action switches.

Pushbutton Switches, Tiny, Straight or Right Angle, Flush Actuator

SEE PAGE D6 FOR PRODUCT SPECIFICATIONS

SPST/SPDT
Wire Lugs 10-48 Bushing



TPCF13C

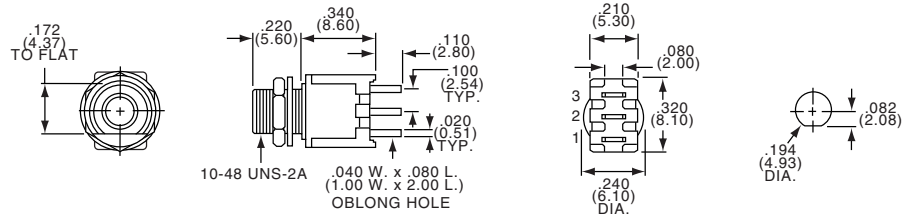

Model	Silver Contacts	Type	Act. Code P. M6	Action	Bushing Type
TPCF13C(*)		SPST	C	N.O. Momentary	Threaded
TPCF13F(*)		SPDT	F	Momentary	Threaded

(*) Specify button color by adding suffix numbers: (0) Black, (2) Red.
Note: No center terminal on "C" action switch.

SPST/SPDT
PC 10-48 Bushing



TPBF11FGPC



TPCF11CGPC

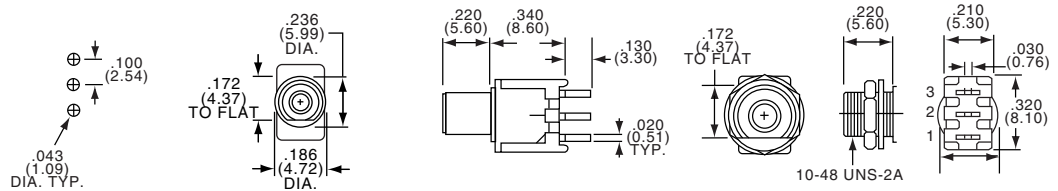

TPB SERIES

TPC SERIES

Model	Gold Contacts	Type	Act. Code P. M6	Action	Bushing Type
TPBF11CGPC(*)		SPST	C	N.O. Momentary	Unthreaded
TPBF11FGPC(*)		SPDT	F	Momentary	Unthreaded
TPCF11CGPC(*)		SPST	C	N.O. Momentary	Threaded
TPCF11FGPC(*)		SPDT	F	Momentary	Threaded

(*) Specify button color by adding suffix numbers: (0) Black, (2) Red.
Note: No center terminal on "C" action switch.

SPST/SPDT
RA 10-48 Bushing



TPBF11CGRA

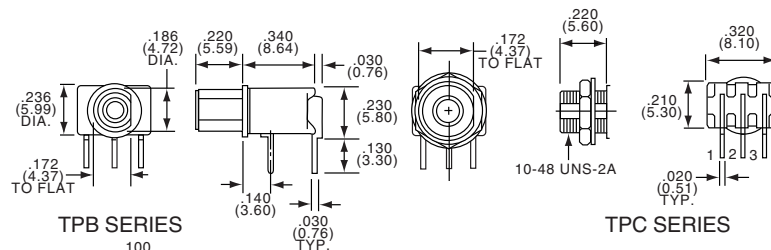

TPB SERIES

TPC SERIES

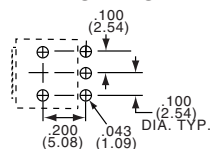

Model	Gold Contacts	Type	Act. Code P. M6	Action	Bushing Type
TPBF11CGRA(*)		SPST	C	N.O. Momentary	Unthreaded
TPBF11FGRA(*)		SPDT	F	Momentary	Unthreaded
TPCF11CGRA(*)		SPST	C	N.O. Momentary	Threaded
TPCF11FGRA(*)		SPDT	F	Momentary	Threaded

(*) Specify button color by adding suffix numbers: (0) Black, (2) Red.
Note: No center terminal on "C" action switch.

Pushbutton Switches, Tiny, Vertical Right Angle, Unthreaded or 10-48 Bushing

SEE PAGE D6 FOR PRODUCT SPECIFICATIONS

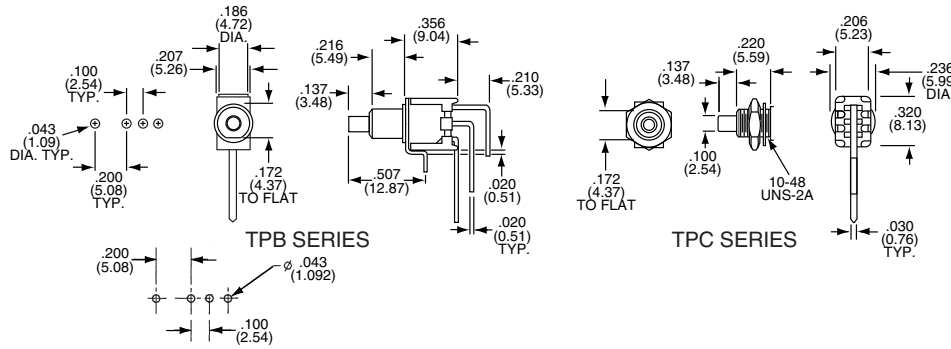

TPB11FGVRA

Model	Type	Act. Code P. M6	Action	Contact Type
TPB11CGVRA(*)	SPST	C	N.O. Momentary	Gold
TPB11FGVRA(*)	SPDT	F	Momentary	Gold
TPC11CGVRA(*)	SPST	C	N.O. Momentary	Gold
TPC11FGVRA(*)	SPDT	F	Momentary	Gold

(*) Specify button color by adding suffix number: (0) Black, (2) Red.
 Note: No center terminal on "C" action switches.

D
TP Series

Pushbutton Switches, Tiny, Vertical, Unthreaded or 1/4-40 Bushing

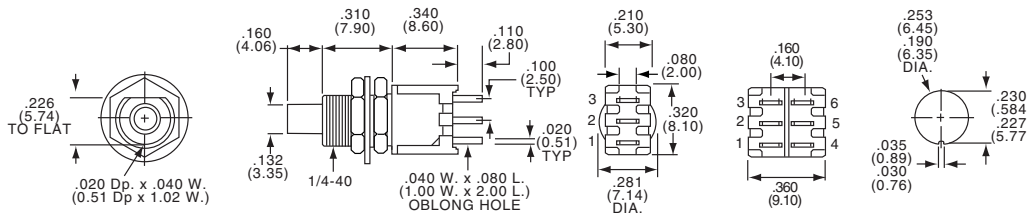

TPF23M

TPF13C

Model	Type	Act. Code P. M6	Action	Contact Type
TPF13C(*)	SPST	C	N.O. Momentary	Silver
TPF13F(*)	SPDT	F	Momentary	Silver
TPF23M(*)	DPST	M	N.O. Momentary	Silver
TPF23R(*)	DPDT	R	Momentary	Silver

(*) Specify button color by adding suffix number: (0) Black, (2) Red.
 Note: No center terminal on "C" or "M" action switches.

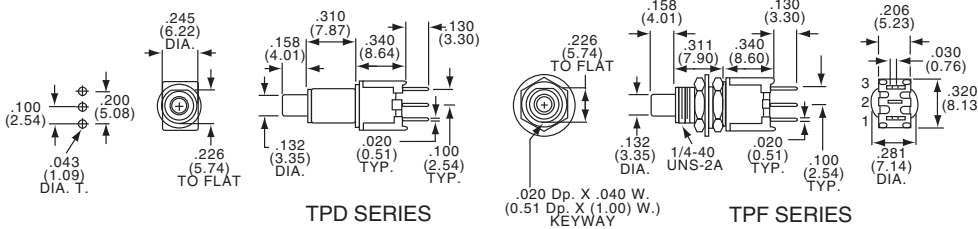

SPST/SPDT



TPD11CGPC

Model	Type	Act. Code P. M6	Action	Bushing Dia.	Contact Type
TPD11CGPC(*)	SPST	C	N.O. Momentary	.250	Gold
TPD11FGPC(*)	SPDT	F	Momentary	.250	Gold
TPF11CGPC(*)	SPST	C	N.O. Momentary	1/4-40	Gold
TPF11FGPC(*)	SPDT	F	Momentary	1/4-40	Gold

(*) Specify button color by adding suffix number: (0) Black, (2) Red.
 NOTE: No center terminal on "C" action switch.

Pushbutton Switches, Tiny, Vertical or Right Angle, Unthreaded or 1/4-40 Bushing

SEE PAGE D6 FOR PRODUCT SPECIFICATIONS

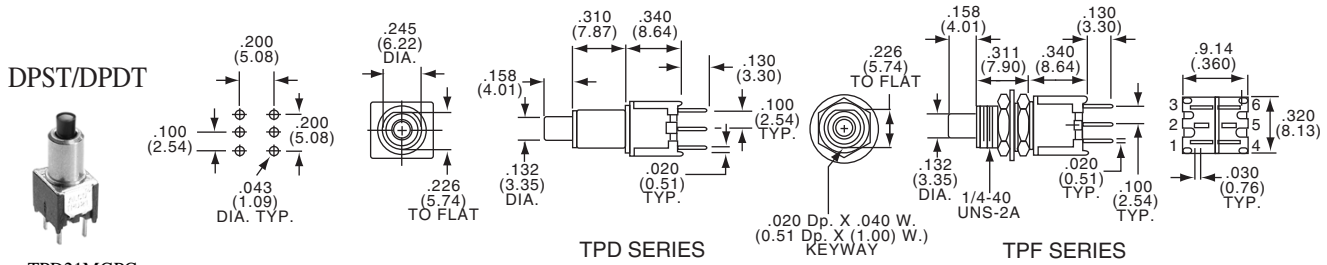

D

TPD/TPF Series

Model	Type	Act. Code	P. M6	Action	Bushing Dia.	Contact Type
TPD21MGPC(*)	DPST	M		N.O. Momentary	.250	Gold
TPD21RGPC(*)	DPDT	R		Momentary	.250	Gold
TPF21MGPC(*)	DPST	M		N.O. Momentary	1/4-40	Gold
TPF21RGPC(*)	DPDT	R		Momentary	1/4-40	Gold

(*) Specify button color by adding suffix number: (0) Black, (2) Red.
Note: No center terminals on "M" Action switches.

SPST/SPDT

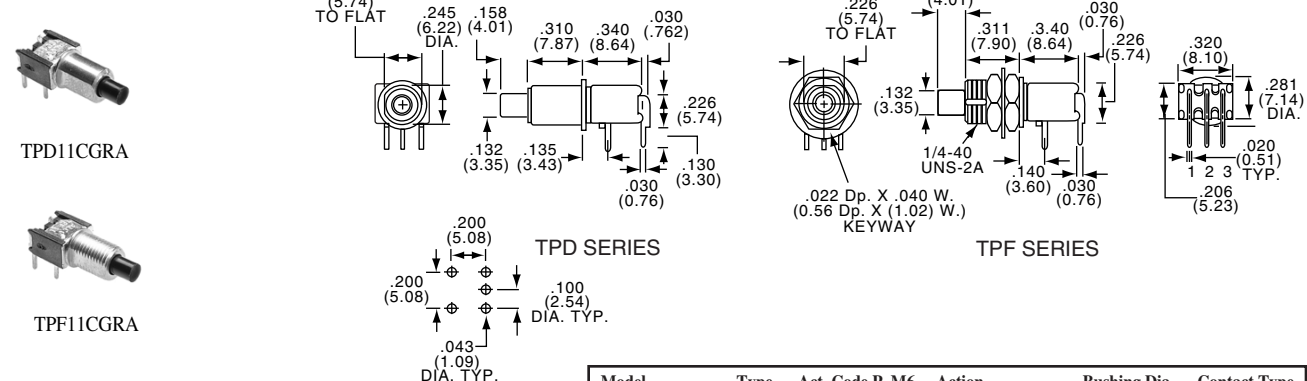

Model	Type	Act. Code	P. M6	Action	Bushing Dia.	Contact Type
TPD11CGRA(*)	SPST	C		N.O. Momentary	.250	Gold
TPD11FGRA(*)	SPDT	F		Momentary	.250	Gold
TPF11CGRA(*)	SPDT	C		N.O. Momentary	1/4-40	Gold
TPF11FGRA(*)	SPDT	F		Momentary	1/4-40	Gold

(*) Specify button color by adding suffix number: (0) Black, (2) Red.
Note: No center terminal on "C" action switch.

DPST/DPDT

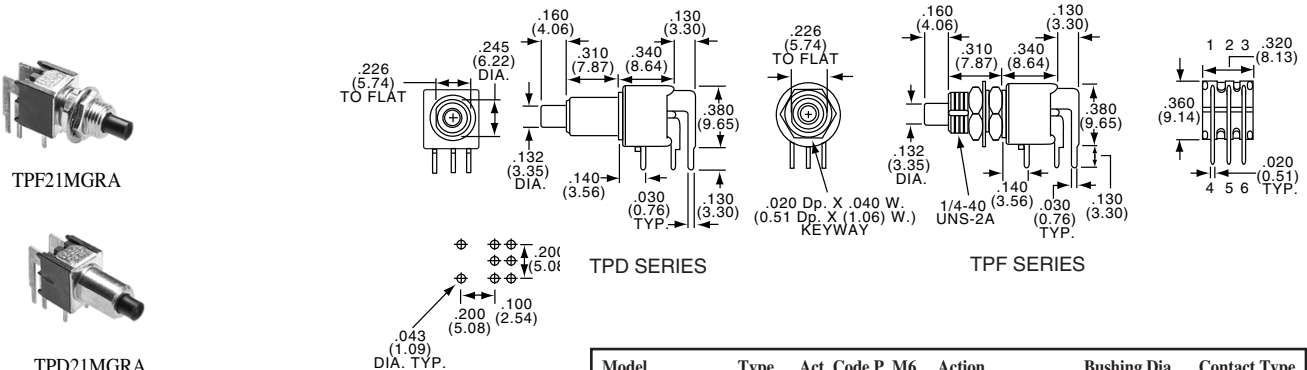

Model	Type	Act. Code	P. M6	Action	Bushing Dia.	Contact Type
TPD21MGRA(*)	DPST	M		N.O. Momentary	.250	Gold
TPD21RGRA(*)	DPDT	R		Momentary	.250	Gold
TPF21MGRA(*)	DPST	M		N.O. Momentary	1/4-40	Gold
TPF21RGRA(*)	DPDT	R		Momentary	1/4-40	Gold

(*) Specify button color by adding suffix number: (0) Black, (2) Red.
Note: No center terminal on "M" Action switches.