

Pushbutton or Keylock or Selector Switches, 22mm, Oil-Tight

MOMENTARY

Metal Bushings

Contact blocks not supplied, order separately. (See page I8.)

Model	Type
QM010(*)	Flush Button
QM020(*)	Extended Button

(*) Specify color by adding suffix number:

(0) Black, (2) Red, (4) Yellow, (5) Green, (6) Blue, (8) Grey, (9) White.

Note: Front beveled frame is black.

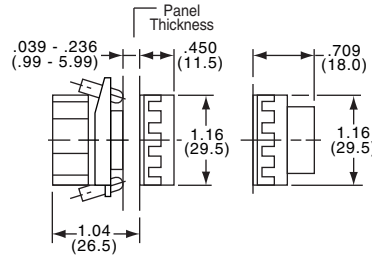

QM010(*)

Thermoplastic Bushings (Threaded)

Contact blocks not supplied, order separately. (See page I8.)

Model	Type
QT010(*)	Flush Button
QT020(*)	Extended Button

(*) Specify color by adding suffix number:

(0) Black, (2) Red, (4) Yellow, (5) Green, (6) Blue, (8) Grey, (9) White.

Note: Front beveled frame is black.

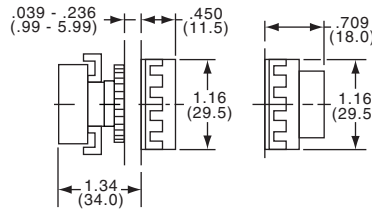

QT010(*)

2 POSITION SELECTORS/KEYLOCK MAINTAINED

Metal Bushings

Contact blocks not supplied, order separately.

(See page I8.)

Tyco Electronics	Alcoswitch	Action	Throw	CAM	Remove Key
7-1437614-7	RM4040	Maintained, Black	120°	1	Long Selector
7-1437614-0	RM3040	Maintained, Black	120°	1	Selector
5-1437614-4	RM200	Maintained	60°	1	⊕
5-1437614-5	RM201	Maintained	60°	1	⊗
6-1437614-5	RM250	Momentary, Right	60°	1	⊕
5-1437614-6	RM204	Maintained	120°	1	⊗
5-1437614-7	RM205	Maintained	120°	1	⊗
1437614-1	E1	Spare Key			⊗

Note: Front beveled frame is black.

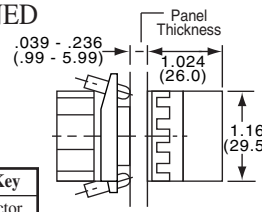

RM4040



RM3040



RM200/201 with/2 keys

3 POSITION SELECTORS

Short Handle, Metal Bushings

Contact blocks not supplied, order separately. (See page I8.)

Tyco Electronics	Alcoswitch	Action	CAM	Tyco Electronics	Alcoswitch	Action	CAM
7-1437614-1	RM3100	Maintained, Black	2	7-1437614-4	RM3700	Momentary, Right Side, Black	2
7-1437614-2	RM3120	Maintained, Black	3	7-1437614-5	RM3800	Double Momentary, Black	2
7-1437614-3	RM3130	Maintained, Black	4	7-1437614-6	RM3830	Double Momentary, Black	4

Note: Front beveled frame is black.

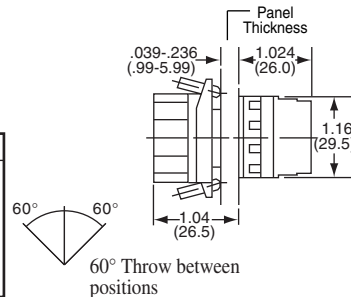

RM3100

Long Handle, Metal Bushings

Contact blocks not supplied, order separately. (See page I8.)

Tyco Electronics	Alcoswitch	Action	CAM	Tyco Electronics	Alcoswitch	Action	CAM
7-1437614-8	RM4100	Maintained	2	—	RM4700	Momentary, Right Side	2
—	RM4120	Maintained	3	7-1437614-9	RM4800	Double Momentary	2
—	RM4130	Maintained	4				

Note: Front beveled frame is black.

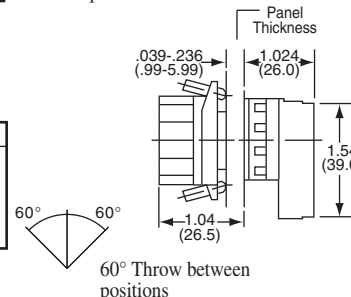

RM4100

Keylock or Pushbutton Switches, 22mm, Oil-Tight or Pilot Lights

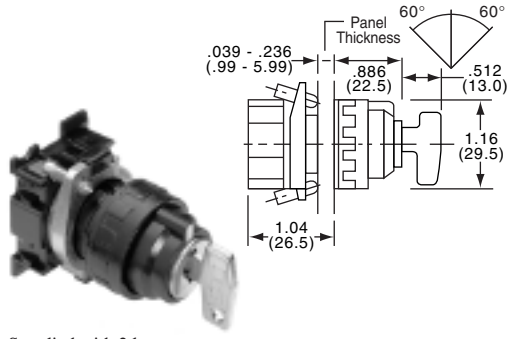

Supplied with 2 keys

3 POSITION KEYLOCK SELECTOR MAINTAINED OR MOMENTARY

Metal Bushings

Contact blocks not supplied, order separately. (See page I8.)

Tyco Electronics	Alcoswitch	Action	CAM	Remove Key	Tyco Electronics	Alcoswitch	Action	CAM	Remove Key
5-1437614-8	RM210	Maintained	2	⊙	6-1437614-4	RM243	Maintained	4	⊙
5-1437614-9	RM220	Maintained	2	⊙	6-1437614-6	RM270	Mom. Right Side	2	⊙
6-1437614-0	RM222	Maintained	3	⊙	6-1437614-7	RM272	Mom. Right Side	3	⊙
6-1437614-1	RM230	Maintained	2	⊙	6-1437614-8	RM273	Mom. Right Side	4	⊙
6-1437614-2	RM232	Maintained	3	⊙	6-1437614-9	RM280	Mom. Both Sides	2	⊙
6-1437614-3	RM233	Maintained	4	⊙	1437614-1	E1	Spare Key		⊙
—	RM240	Maintained	2	⊙					

Note: Front beveled frame is black.



QM600 (RM600)

Metal Bushing



SR601 Threaded Thermoplastic Bushing Front lampable

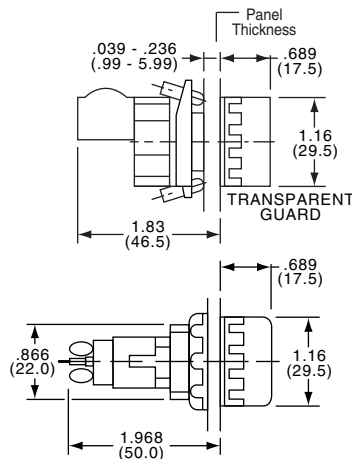

PILOT LIGHTS (FULL VOLTAGE TYPE)

Lamps: order separately, miniature bayonet base. (See page I15.)

Lamps: use G3 1/2 on QM600(*), use T3 1/4 on SR601(*), RM600(*). Custom legends available.

Model	Type
QM600(*)	Square pilot light, metal bushing
SR601(*)	Round pilot light, plastic bushing screw turn
RM600(*)	Round pilot light, metal bushing

(*) Specify color by adding suffix number: (2) Red, (3) Orange, (4) Yellow, (5) Green, (6) Blue, (9) White.

Reliant'22

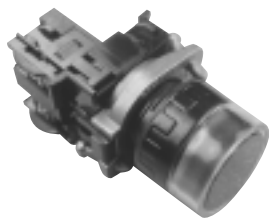

RM120(*)

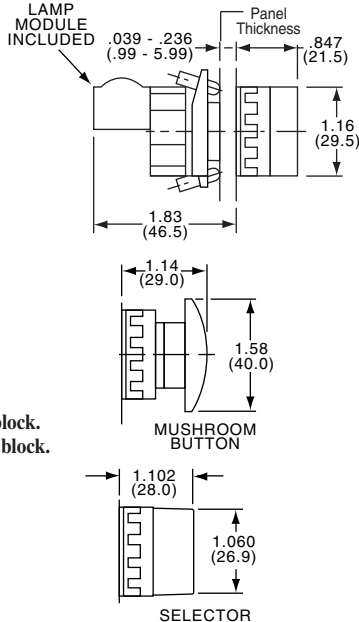

Application Note:
+V40/F40 used for N.C contact block.
+VA0/FA0 used for N.O. contact block.

ILLUMINATED/ROUND MOMENTARY/MAINTAINED

Metal Bushing

Contact blocks not supplied, order separately. (See page I8.)

Lamp circuit isolated. Order lamp separately. (See page I15.)

Lamps: Use T-3 1/4 or G3 1/2 incandescent or neon lamps.

Tyco Electronics	Alcoswitch	Action	Type	Cam Type
—	RM120(*)	Momentary	Extended Button	
—	RM122(*)	Momentary	Guarded Button	
—	+RM130(*)	Maintained	Flush Button	} Push-On - Push-Off See Application Note
—	+RM145(*)	Maintained	Mushroom	
—	RM150(*)	Momentary	Mushroom	
5-1437614-3	RM1652	Twist Release	Mushroom, Red	
Illuminated Selectors				
—	RM650(*)	Maintained	2-Pos. Selector**1	
—	RM653(*)	Maintained	3-Pos. Selector**2	

When operating from line voltage use step down transformers 5B0 or 570. (See page I15.)
(*) Specify color by adding suffix number: (2) Red, (4) Yellow, (5) Green, (6) Blue, (9) White.

Note: RM145 and RM150 available only in red, yellow, green.

**Use G3 1/2 lamps only.

Note: Front beveled frame is black.

Pushbutton Switches, 22mm, Oil-Tight, Round or Square Buttons

SQUARE, MOMENTARY ILLUMINATED

Metal Bushing

Contact blocks not supplied, order separately. (See page I8.)

Lamp circuit isolated. Order lamps separately.

Lamps: Use G3 1/2. (See page I15.)

Custom legends available.

Model	Type
QM122(*)	Flush Button
QM120(*)	Extended Button

When operating from line voltage use step down transformers 5B0 or 570. (See page I15.)
 (*) Specify color by adding suffix number: (2) Red, (4) Yellow, (5) Green, (6) Blue, (9) White.

Note: Front beveled frame is black.

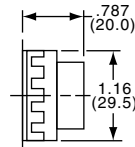
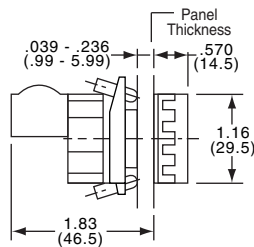

QM122(*)



QM120(*)

ROUND, MOMENTARY ILLUMINATED

Thermoplastic

Contact blocks not supplied, order separately. (See page I8.)

Lamp circuit isolated. Order lamps separately. (See page I15.)

Lamps: use T-3 1/4 or G3 1/2 incandescent or neon lamps.

Model	Action	Type
RT120(*)	Momentary	Extended Button

When operating from line voltage use step down transformers 5B0 or 570. (See page I15.)
 (*) Specify color by adding suffix number: (2) Red, (4) Yellow, (5) Green, (6) Blue, (9) White.

Note: Front beveled frame is black.

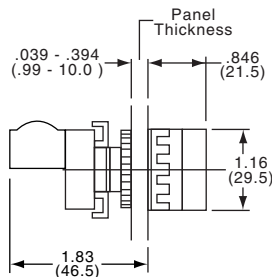

RT120(*)