

E020 Series Sealed Snap-acting Momentary Pushbutton Switches



A

Pushbutton

Features/Benefits

- Process sealed with disposable splashproof boot
- Long life contact design
- Snap-fitting plunger available
- RoHS compliant models available

Typical Applications

- Instrumentation
- Telecommunications and networking equipment
- Computers and peripherals



Models Available

Specifications

CONTACT RATING: B contact material (EX25 Models): 0.4 VA max. @ 20 V AC or DC max. G contact material (EX21 Models): 1 AMP @120 V AC or 28 V DC or 0.4 VA max. @ 20 V AC or DC max. Note: Break-before-make contacts. Multi-pole contacts do not make and break simultaneously. See page A-26 for additional ratings.

ELECTRICAL LIFE: 60,000 make-and-break cycles at full load.

CONTACT RESISTANCE: Below 50 mΩ typ. initial @ 2–4 V DC, 100 mA, for both silver and gold plated contacts.

INSULATION RESISTANCE: 10⁹Ω min.

DIELECTRIC STRENGTH: 1000 Vrms min. @ sea level.

OPERATING TEMPERATURE: –30°C to 75°C.

CAP INSTALLATION FORCE: 10 lbs. max. permissible.

SOLDERABILITY: Per MIL-STD-202F method 208D, or EIA RS-186E method 9 (1 hour steam aging).

NOTE: Any models supplied with P, R, B or G contact material are RoHS compliant.

NOTE: Specifications and materials listed above are for switches with standard options. For information on specific and custom switches, consult Customer Service Center.

Materials

CASE & BUSHING: Glass filled nylon 6/6, flame retardant (UL 94V-0).

PLUNGER: Glass filled nylon or glass filled polyester (PBT) (UL 94V-0).

SWITCH SUPPORT: Brass or steel, matte-tin.

SWITCH SUPPORT RETAINER: Stainless steel.

N.O. & N.C. CONTACTS: EX25 MODELS: B contact material: Copper alloy, with gold plate over nickel plate. EX21 MODELS: G contact material: Coin silver, with gold plate over nickel plate. See page A-26 for additional contact materials.

COMMON CONTACTS & ALL TERMINALS: Copper alloy, with gold plate over nickel plate. See page A-26 for additional contact materials.

TERMINAL SEAL: Epoxy.

DISPOSABLE BOOT: Vinyl splashproof boot supplied standard. Remove and discard only after soldering and cleaning processes are complete.

Build-A-Switch

To order, simply select desired option from each category and place in the appropriate box. Available options are shown and described on pages A-22 thru A-28. For additional options not shown in catalog, consult our Customer Service Center. All models are process sealed to withstand machine soldering temperatures and pressure wash cleaning methods.

<input type="checkbox"/> <input type="checkbox"/> <input type="checkbox"/> <input type="checkbox"/> <input type="checkbox"/> <input type="checkbox"/> <input type="checkbox"/> <input type="checkbox"/> <input type="checkbox"/> <input type="checkbox"/>					
<p>Switch Function</p> <p>E121 SPDT On-Mom. 1 Amp</p> <p>E221 DPDT On-Mom. 1 Amp</p> <p>E125 SPDT On-Mom. 0.4VA</p> <p>E225 DPDT On-Mom. 0.4VA</p>	<p>Plunger</p> <p>S .282" high</p> <p>M .331" high, snap-fitting</p> <p>S1 .332" high</p>	<p>Bushing</p> <p>D1 Unthreaded</p> <p>D3 .180" high, unthreaded</p>	<p>Terminations</p> <p>A Right angle, PC thru-hole</p> <p>AV2 Vertical right angle, PC thru-hole</p> <p>C PC Thru-hole</p> <p>A3 Right angle, snap-in, PC thru-hole</p> <p>AV3 Vertical right angle, snap-in, PC thru-hole</p> <p>V3 .460" high, V-bracket</p> <p>V4 .630" high, V-bracket</p> <p>V6 .460" high, V-bracket</p> <p>V8 .953" high, V-bracket</p> <p>V31 .460" high, snap-in V-bracket</p> <p>V41 .630" high, snap-in V-bracket</p> <p>V61 .460" high, snap-in V-bracket</p>	<p>Contact Material</p> <p>B Gold</p> <p>G Gold over silver</p> <p>P Gold, matte-tin</p> <p>R Gold over silver, matte-tin</p>	<p>Seal</p> <p>E Epoxy and disposable splashproof boot</p>



Dimensions are shown: Inches (mm)
Specifications and dimensions subject to change



E020 Series Sealed Snap-acting Momentary Pushbutton Switches

Pushbutton A

SWITCH FUNCTION

NO. POLES	MODEL NO.	SWITCH FUNCTION		CONNECTED TERMINALS		SCHEMATIC
		POS. 1	POS. 2	POS. 1	POS. 2	
SP	E121	ON	MOM.	1-3	1-2	
	E125	ON	MOM.			
SPDT <p>Part number shown: E121SD1CGE</p> <p>Terminal Nos. For Reference Only</p>						
DP	E221	ON	MOM.	1-3,4-6	1-2,4-5	
	E225	ON	MOM.			
DPDT <p>Part number shown: E221SD1CBE</p> <p>Terminal Nos. For Reference Only</p>						

MOM. = Momentary

E121, E221 models with all options when ordered with G or R contact material.

EX25 models must be ordered with B or P contact material.
EX21 models must be ordered with G or R contact material.

PLUNGER

S .282" HIGH

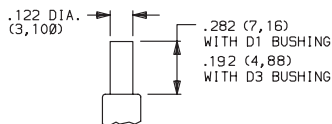

S1 .332" HIGH

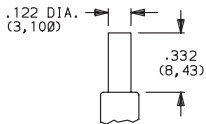

Not Available with D1 bushing.

M .332" HIGH SNAP-FITTING

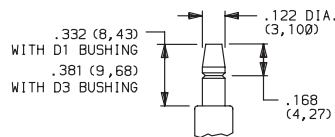

NOTE: Caps available for all plunger options, see page A-27.

BUSHING

D1 UNTHREADED

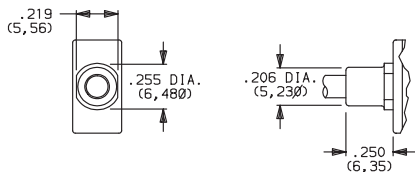

Not available with S1 actuator.

D3 .180" HIGH UNTHREADED

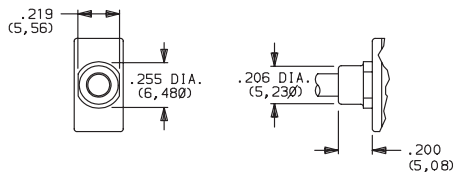

NOTE: Disposable splashproof vinyl over actuator and bushing supplied std., see page A-26.

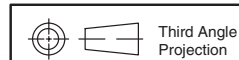

Dimensions are shown: Inches (mm)
Specifications and dimensions subject to change



E020 Series Sealed Snap-acting Momentary Pushbutton Switches



A

Pushbutton

TERMINATIONS

C PC THRU-HOLE

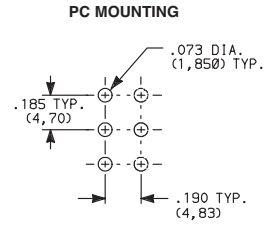
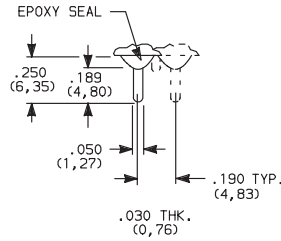

SPDT and DPDT

A RIGHT ANGLE, PC THRU-HOLE

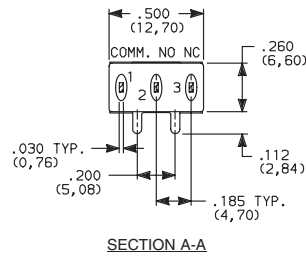
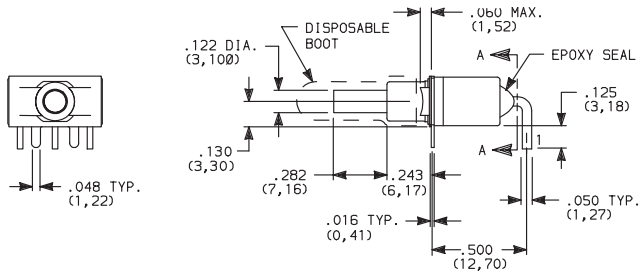

E121SD1AGE SPDT

A3 RIGHT ANGLE, SNAP-IN, PC THRU-HOLE

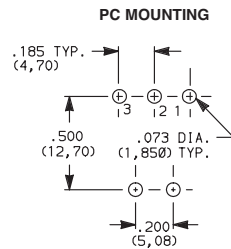

NOTE: Terminal bend radii and lead-in manufacturing option.

A RIGHT ANGLE, PC THRU-HOLE

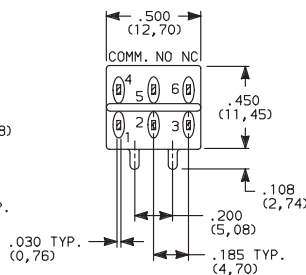
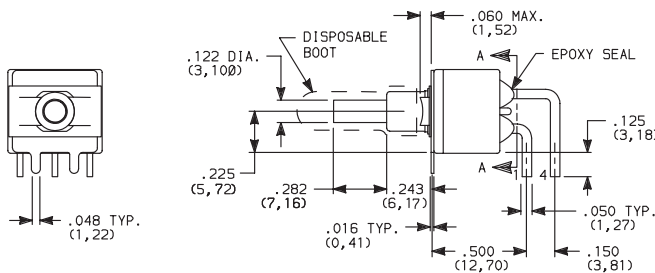

E221SD1AGE DPDT

A3 RIGHT ANGLE, SNAP-IN, PC THRU-HOLE

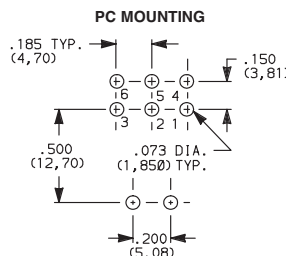

NOTE: Terminal bend radii and lead-in manufacturing option.



Dimensions are shown: Inches (mm)
Specifications and dimensions subject to change



www.ck-components.com



A

Pushbutton

E020 Series Sealed Snap-acting Momentary Pushbutton Switches

TERMINATIONS



AV2 VERTICAL RIGHT ANGLE, PC THRU-HOLE, .150" PITCH



E121SD1AV2GE SPDT

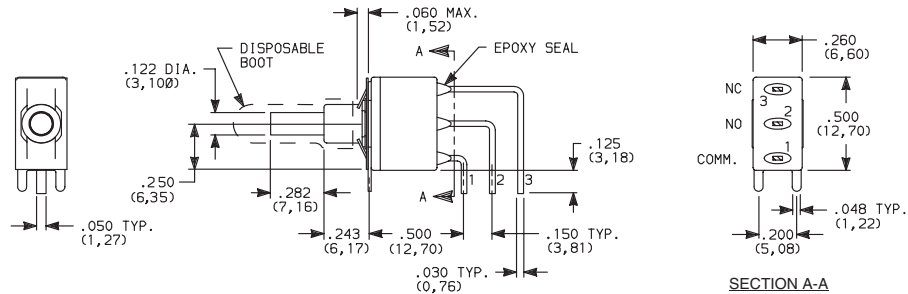

SECTION A-A

AV3 VERTICAL RIGHT ANGLE, SNAP-IN, PC THRU-HOLE, .150" PITCH

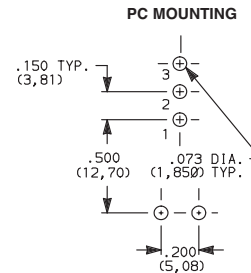
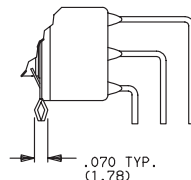
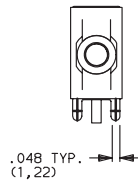

NOTE: Terminal bend radii and lead-in manufacturing option.

AV2 VERTICAL RIGHT ANGLE, PC THRU-HOLE, .150" PITCH



E221SD1AV2GE DPDT

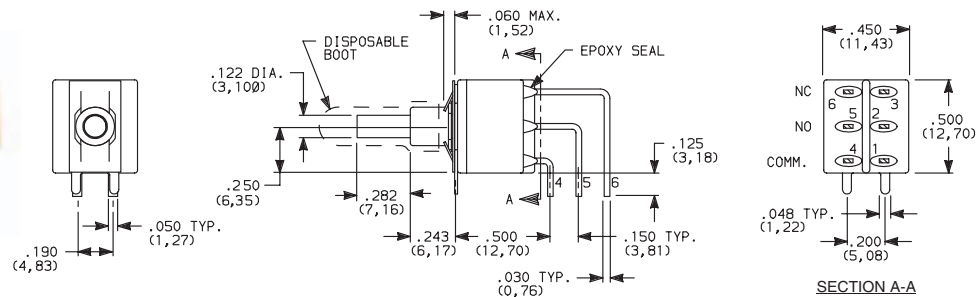

SECTION A-A

AV3 VERTICAL RIGHT ANGLE, SNAP-IN, PC THRU-HOLE, .150" PITCH

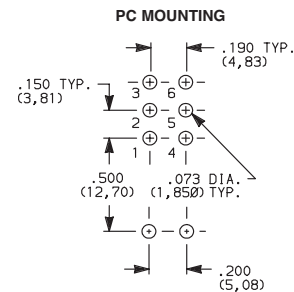
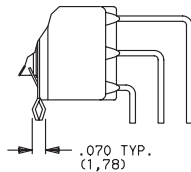
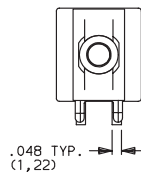

NOTE: Terminal bend radii and lead-in manufacturing option.

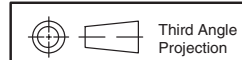

Dimensions are shown: Inches (mm)
Specifications and dimensions subject to change



www.ck-components.com

E020 Series Sealed Snap-acting Momentary Pushbutton Switches



A

Pushbutton

TERMINATIONS

V3, V4 VERTICAL MOUNT, V-BRACKET

V31, V41 VERTICAL MOUNT, V-BRACKET, SNAP-IN

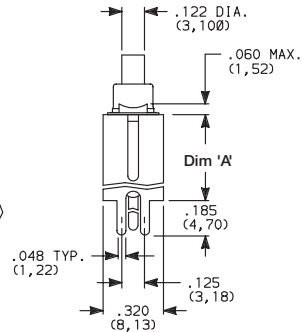
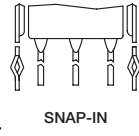
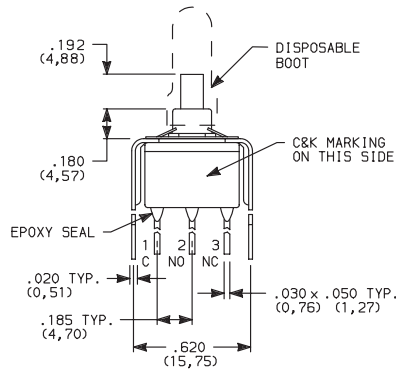

PC MOUNTING

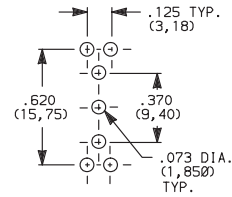

E121SD3_GE SPDT

OPTION CODE	DIM 'A'
V3, V31	.460 (11,68)
V4, V41	.630 (16,00)

V3, V4 VERTICAL MOUNT, V-BRACKET

V31, V41 VERTICAL MOUNT, V-BRACKET, SNAP-IN

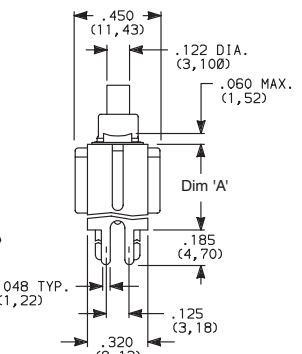
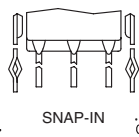
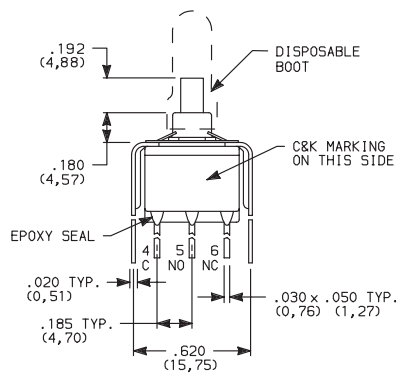

PC MOUNTING

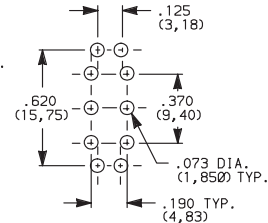

E221SD3_GE DPDT

OPTION CODE	DIM 'A'
V3, V31	.460 (11,68)
V4, V41	.630 (16,00)

V6, V8 VERTICAL MOUNT, V-BRACKET

V61, V81 VERTICAL MOUNT, V-BRACKET, SNAP-IN

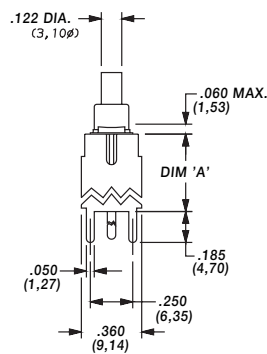
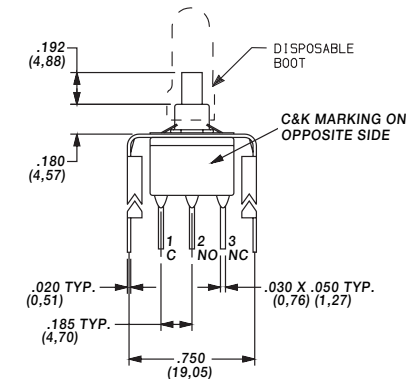

PC MOUNTING

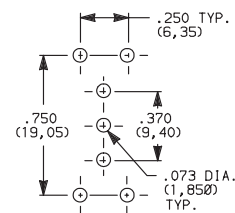

E121SD3_GE SPDT

OPTION CODE	DIM 'A'
V6, V61	.460 (11,68)
V8, V81	.953 (24,21)



Dimensions are shown: Inches (mm)
Specifications and dimensions subject to change

www.ck-components.com



E020 Series Sealed Snap-acting Momentary Pushbutton Switches

Pushbutton A

TERMINATIONS

V6, V8 VERTICAL MOUNT, V-BRACKET

V61, V81 VERTICAL MOUNT, V-BRACKET, SNAP-IN



E221SD3V6GE DPDT

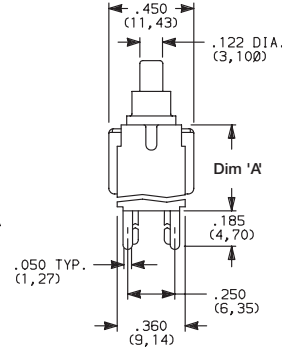
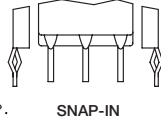
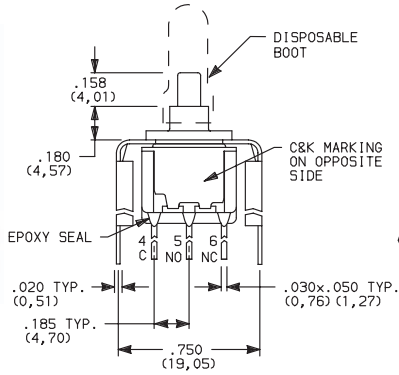

PC MOUNTING

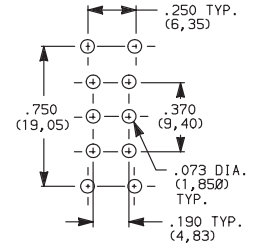

OPTION CODE	DIM 'A'
V6, V61	.460 (11,68)
V8, V81	.953 (24,21)

CONTACT MATERIAL

OPTION CODE	CONTACT MATERIAL	TERMINAL PLATING	RATINGS	
			LOW LEVEL/DRY CIRCUIT	EX25 MODELS ONLY: 0.4 VA MAX. @ 20 V AC OR DC MAX.
B	GOLD ¹	GOLD ¹	LOW LEVEL/DRY CIRCUIT	EX25 MODELS ONLY: 0.4 VA MAX. @ 20 V AC OR DC MAX.
P		MATTE-TIN ⁴		
G	GOLD OVER SILVER ^{2,3}	GOLD ³	LOW LEVEL/DRY CIRCUIT OR POWER	EX21 MODELS ONLY: 0.4 VA MAX @ 20 V AC OR DC MAX. OR 1 AMP @ 120 V AC OR 28 V DC.
R		MATTE-TIN ⁴		

* Note: See Technical Data section of this catalog for RoHS compliant and compatible definitions and specifications.

- 1 CONTACTS & TERMINALS: Copper alloy, with gold plate over nickel plate.
- 2 N.O. AND N.C. CONTACTS: Coin silver, with gold plate over nickel plate.
- 3 COMMON CONTACTS & ALL TERMINALS: Copper alloy, with gold plate over nickel plate.
- 4 TERMINALS: Copper alloy, with matte-tin alloy over nickel plate.

NOTE: Any models supplied with P, R, B or G contact material are RoHS compliant.

E121, E221 models with all options when ordered with mandatory G, or R contact material.

P or B contact material must be ordered with EX25 models.

R or G contact material must be ordered with EX21 models.

SEAL

E EPOXY SEAL AND DISPOSABLE SPLASHPROOF BOOT

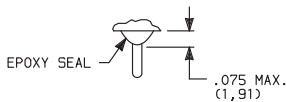

Disposable splashproof boot supplied standard. Remove and discard boot *only after* soldering and cleaning processes are complete.

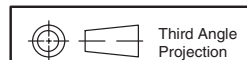
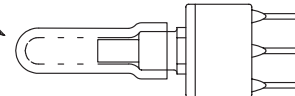

Dimensions are shown: Inches (mm)
Specifications and dimensions subject to change

www.ck-components.com

E020 Series Sealed Snap-acting Momentary Pushbutton Switches



A Pushbutton

AVAILABLE HARDWARE

Cap

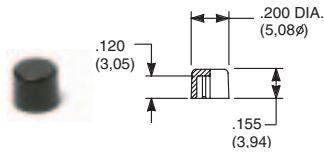

PART NO.

- 708901000 WHITE
- 708902000 BLACK
- 708903000 RED

Material: Nylon
Finish: Gloss

Cap

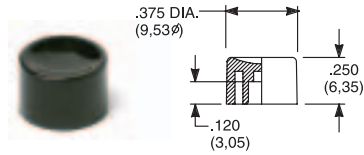

PART NO.

- 752701000 WHITE
- 752702000 BLACK
- 752703000 RED

Material: Nylon
Finish: Gloss

Cap

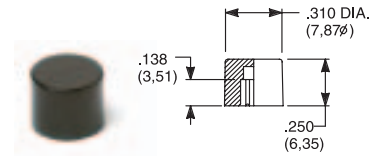

PART NO.

- 801801000 WHITE
- 801802000 BLACK
- 801803000 RED

Material: Nylon
Finish: Gloss

Cap, Snap-fitting plunger

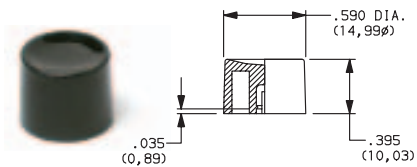

PART NO.

- 894001000 WHITE
- 894002000 BLACK
- 894003000 RED

Material: Nylon
Finish: Gloss

Cap, Snap-fitting plunger

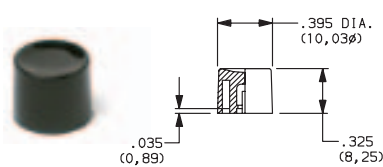

PART NO.

- 894101000 WHITE
- 894102000 BLACK
- 894103000 RED

Material: Nylon
Finish: Gloss

Cap

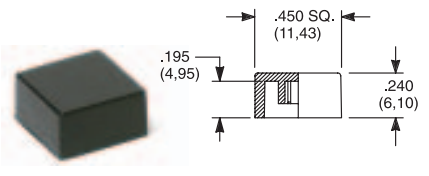

PART NO.

- 484601000 WHITE
- 484602000 BLACK
- 484603000 RED

Material: Nylon
Finish: Gloss

PART NO.

- 798201000 WHITE
- 798202263 BLACK
- 798203000 RED

Material: Nylon
Finish: Matte

NOTE: Other cap colors available, consult Customer Service Center.

Frames snap into panel opening and are independent from switch mounting. Accurate positioning of the PC mounted switch relative to the panel opening is necessary to provide proper clearance between actuator and frame. Available in two basic styles and four panel thicknesses .047-.125 in. Material: Nylon. Finish: Matte.

TYPICAL APPLICATION

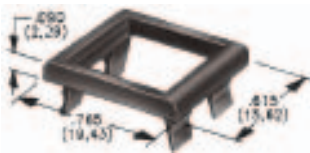
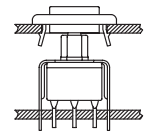

.047" (1,19) PANEL THK.	.062" (1,57) PANEL THK.	.090" (2,29) PANEL THK.	.125" (3,18) PANEL THK.
PART NO.	PART NO.	PART NO.	PART NO.
432501000	432601000	432701000	432801000
432502263	432602263	432702263	432802263
432503000	432603000	432703000	432803000
			WHITE
			BLACK
			RED

PANEL MOUNTING

For part numbers
4325xxxxx, 4326xxxxx

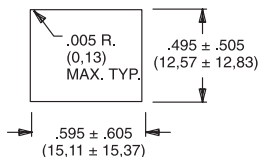

For part numbers
4327xxxxx, 4328xxxxx

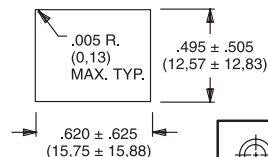

Dimensions are shown: Inches (mm)
Specifications and dimensions subject to change





E020 Series Sealed Snap-acting Momentary Pushbutton Switches

AVAILABLE HARDWARE

A
Pushbutton

PANEL INSERTS

Above frames (part nos. 432XXXXXX) are also available with insert which accepts LED for indicator light assembly. Order insert separately from frame. Blank insert panel (without hole for LED) also available. **LED not included.**

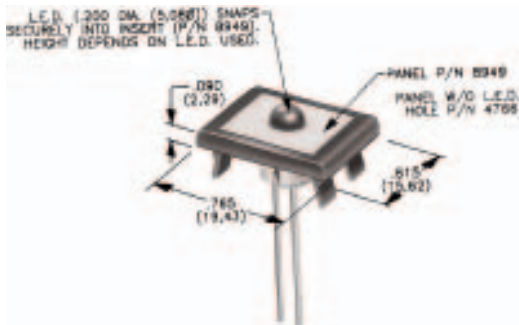

PANEL INSERT
WITH HOLE FOR LED

BLANK PANEL INSERT
WITHOUT HOLE FOR LED

PART NO.

894901000
894902000
894903000

PART NO.

476601000 WHITE
476602000 BLACK
476603000 RED

Special colors, custom markings available, consult Customer Service Center.

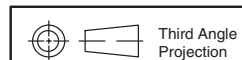

Dimensions are shown: Inches (mm)
Specifications and dimensions subject to change

www.ck-components.com