

**NEW!**

# HDT Series Micro Mini Surface Mount Detect Switches

## Features/Benefits

- **Low profile package**
- **Design allows top or side actuation**
- **Low actuation force, 35 grams max.**
- **Pick and place compatible, available in tape & reel packaging**
- **RoHS compliant and compatible**
- **Halogen free**

## Typical Applications

- **Consumer electronics**
- **Computers**
- **Medical devices**
- **ATCA and MicroTCA devices**

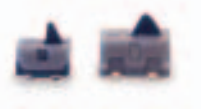

**Advanced TCA®**

**μTCA®**

## Specifications

CONTACT RATING: 1 mA 5 VDC  
 MECHANICAL AND ELECTRICAL LIFE: 100,000 cycles min.  
 CONTACT RESISTANCE: 500 m Ω max. initial.  
 INSULATION RESISTANCE: 100 M Ω min. between adjacent contacts.  
 OPERATING TEMPERATURE: -40°C to + 85°C  
 STORAGE TEMPERATURE: -40°C to + 85°C  
 PACKAGING: Tape & reel

## Materials

BASE: PA 46 (UL94V-0)  
 COVER: PA 46 (UL94V-0)  
 ACTUATOR: PA 46 (UL94V-0)  
 MOVABLE BLADE: Stainless Steel, Ag over Ni plating.  
 TERMINALS: Phosphor Bronze, Ag over Ni plating.  
 SOLDERABILITY: Lead free compatible - No clean.

**NOTE:** Specifications and materials listed above are for switches with standard options. For information on specific and custom switches, consult Customer Service Center.

## Build-A-Switch

Complete part numbers for HDT Series are shown below.

PART NUMBER	PACKAGING	SCHEMATIC
<b>HDT0001</b>	TAPE & REEL 2,450 per reel	

**NOTE:** Available with no locating posts by adding "NP" (HDT0001NP) to Part Number.

### TRAVEL:

Pre-travel: .30 mm  
 Overtravel: .75 mm  
 Total: 1.05 mm

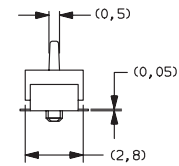
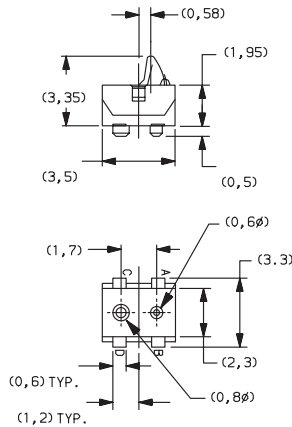

### PC MOUNTING

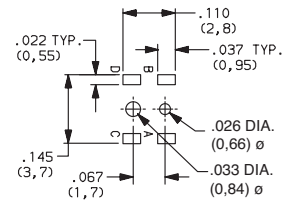

**HDT0001**

## TAPE & REEL

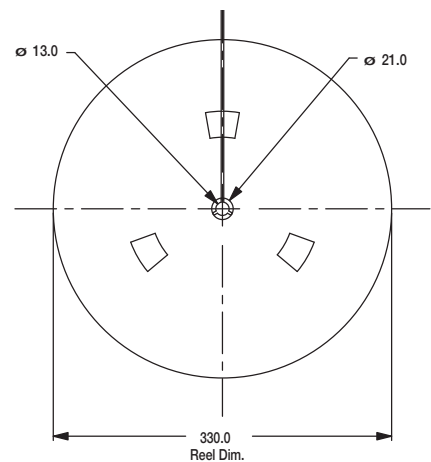
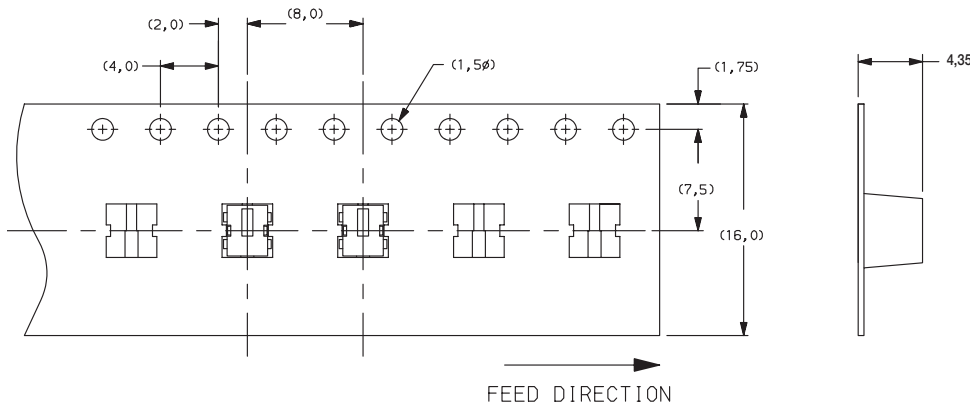

Dimensions are shown: mm  
 Specifications and dimensions subject to change



**Detect**

# HDT Series

## Micro Mini Surface Mount Detect Switches

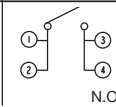
PART NUMBER	PACKAGING	SCHEMATIC
<b>HDT0004</b>	TAPE & REEL 2,800 per reel	

**TRAVEL:**

Pre-travel: .3 mm  
 Overtravel: 1.0 mm  
 Total: 1.3 mm

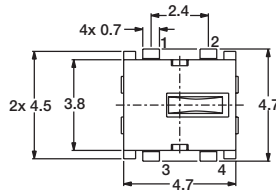

HDT0004

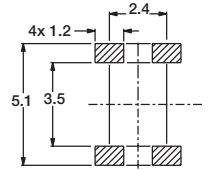
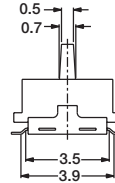
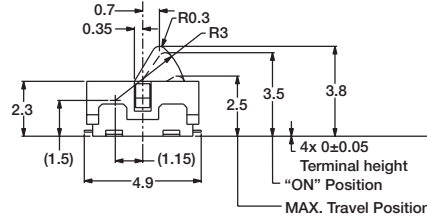

HDT0004

### TAPE & REEL

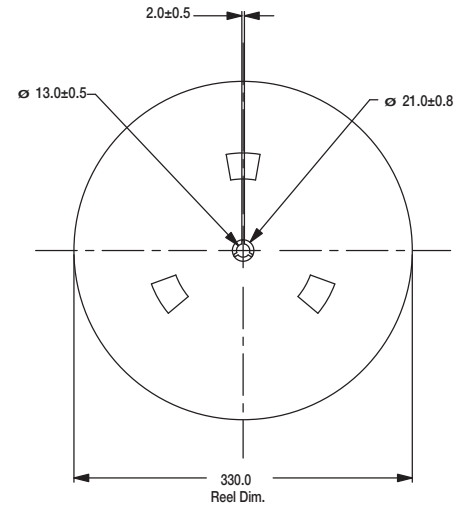
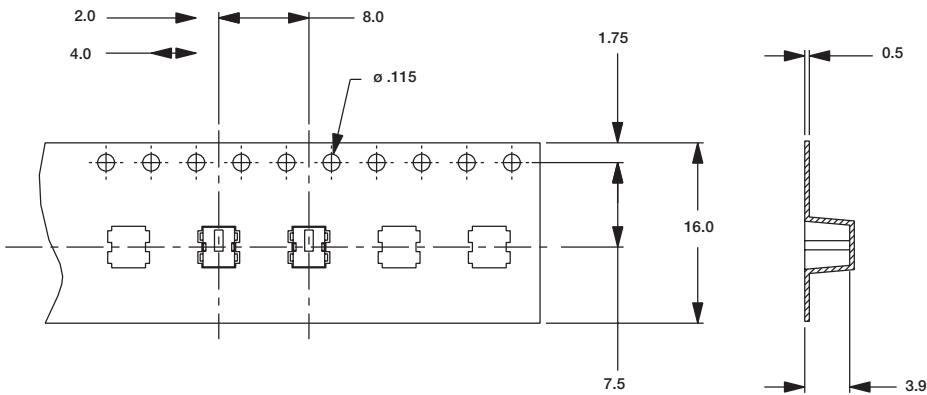

Detect

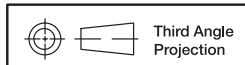

Dimensions are shown: mm  
 Specifications and dimensions subject to change