

# HEDR-8000 Series

## Reflective Optical Surface Mount Encoders



### Data Sheet

HEDR-8000 Series, HEDR-8100 Series  
HEDR-8010 Series

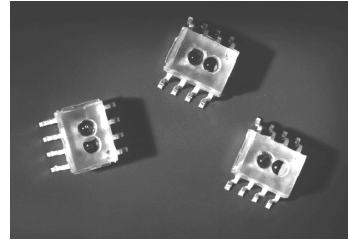

#### Description

The HEDR-8000/8100 Series encoders use reflective technology to sense rotary or linear position. This sensor consists of an LED light source and a photodetector IC in a single SO-8 surface mount package. When used with a reflective codewheel or codestrip, this device can sense rotary or linear position.

**NOTE: HEDR-8000 series products are classified as MSL Level 3.**

#### Features

- Reflective technology
- Surface mount SO-8 Package
- Two channel quadrature outputs for direction sensing
- Two encoding resolution options:
  - 2.76 – 2.95 lines/mm (70 – 75 lines/inch)
  - 5.91 lines/mm (150 lines/inch)

#### Outline Drawing

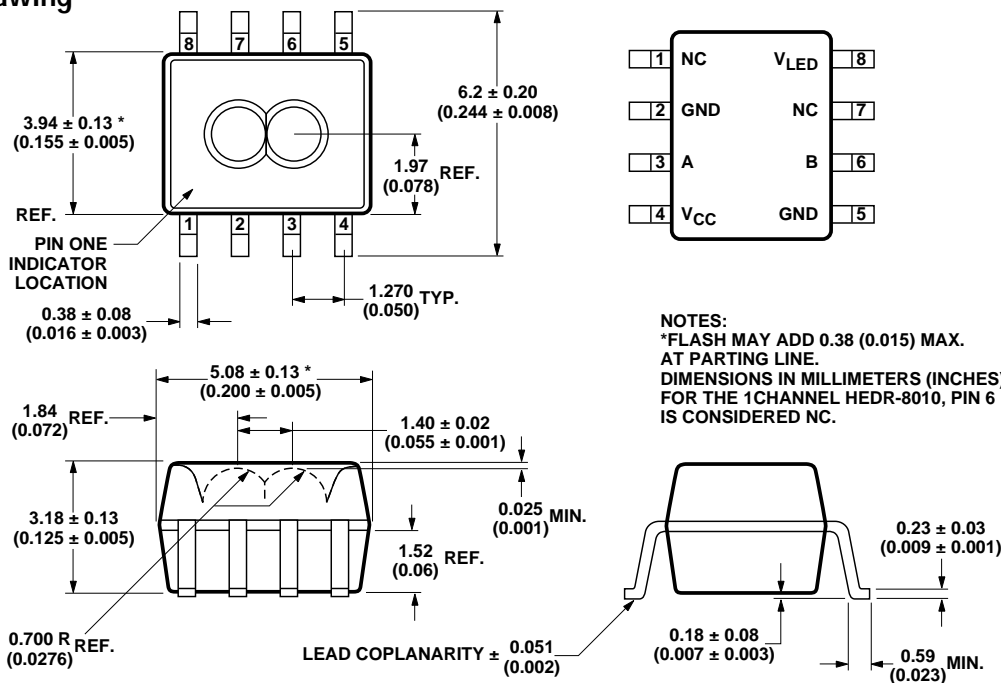

**ESD WARNING: NORMAL HANDLING PRECAUTIONS SHOULD BE TAKEN TO AVOID STATIC DISCHARGE.**

The reflective surface mount optical encoders provide two square wave outputs in quadrature for count and direction information. These TTL compatible outputs correspond to the alternating reflective/non-reflective pattern of the codewheel or codestrip.

The HEDR-8000/8100 series encoders can be used over a range of codewheel and codestrip resolutions. The HEDR-8000/8100 reflective encoder can operate from 2.76 to 2.95 lines per mm (70 to 75 lines per inch). The HEDR-8100 can be used with a codewheel or codestrip with 150 lines per inch (5.91 lines per mm).

### Applications

The HEDR-8000/8100 series provides two channel motion sensing at a very low cost, making

it ideal for high volume applications. Its small size and surface mount capability make it ideal for printers, copiers, card readers, and consumer product applications.

**Note:** Avago Technologies encoders are not recommended for use in safety critical applications. Eg. ABS braking systems, power steering, life support systems and critical care medical equipment. Please contact sales representative if more clarification is needed.

### Theory of Operation

The HEDR-8000/8100 series combines an emitter and a detector in a single surface mount SO-8 package. When used with a codewheel or codestrip, the reflective sensors translates rotary or linear motion into a two channel digital output.

As seen in the block diagram, the HEDR-8000/8100 series has three key parts: a single light emitting diode (LED) light source, a photodetector IC with a set of uniquely configured photodiodes, and a pair of lenses molded into the package. The lens over the LED focuses light onto the codewheel or codestrip. Light is either reflected or not reflected back to the lens over the photodetector IC.

As the codewheel rotates or codestrip passes by, an alternating pattern of light and dark corresponding to the pattern of the codewheel falls upon the photodiodes. This light is used to produce internal signals A and  $\bar{A}$ , and B and  $\bar{B}$ . As part of this “push-pull” detector system, these signals are fed through comparators to produce the final outputs for channels A and B.

### Block Diagram

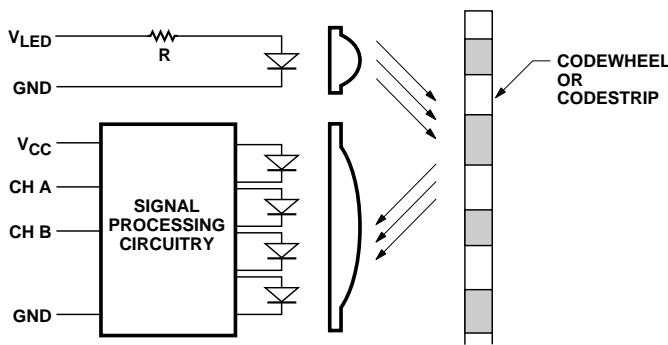

## Definitions

**Count (N):** For rotary motion, the number of bar and window pairs or counts per revolution (CPR) of the codewheel. For linear motion, the number of bar and window pairs per unit length (lines per inch [LPI] or lines per mm [LPmm]).

**One Cycle (C):** 360 electrical degrees ( $^{\circ}$ ), 1 bar and window pair.

**One Shaft Rotation:** 360 mechanical degrees, N cycles (rotary motion only).

**Line Density:** The number of reflective and non-reflective pairs per unit length, expressed as either lines per inch (LPI) or lines per mm (LPmm).

**Pulse Width (P):** The number of electrical degrees that an output is high during one cycle, nominally  $180^{\circ}$  or  $1/2$  a cycle.

**Pulse Width Error ( $\Delta P$ ):** The deviation in electrical degrees of the pulse width from its ideal value of  $180^{\circ}$ .

**State Width (S):** The number of electrical degrees between a transition in the output of channel A and the neighboring transition in the output of channel B. There are 4 states per cycle, each nominally  $90^{\circ}$ .

**State Width Error ( $\Delta S$ ):** The deviation in electrical degrees of each state width from its ideal value of  $90^{\circ}$ .

**Phase ( $\phi$ ):** The number of electrical degrees between the center of the high state on channel A and the center of the high state on channel B. This value is nominally  $90^{\circ}$ .

**Phase Error ( $\Delta\phi$ ):** The deviation in electrical degrees of the phase from its ideal value of  $90^{\circ}$ .

**Direction of Rotation:** When the codewheel or codestrip moves in the direction from pin 1 to pin 4, as viewed when looking down on the lenses, channel B will lead channel A. If the codewheel or codestrip moves in the opposite direction, channel A will lead channel B.

**Optical Radius (Rop):** For rotary motion, the distance from the codewheel's center of rotation to the center line connecting the two lenses of the encoder.

**Gap (G):** The distance from the top of the package to the surface of the reflective codewheel or codestrip.

**Specular Reflectance (R<sub>p</sub>):** a measure of a surface's reflective finish. This is quantified by the amount of light reflected when hit with an incident beam. A device called a scatterometer is used to quantify specular reflectance on a percent scale. (Contact factory for more information.)

## Radial and Tangential

### Misalignment Error (E<sub>R</sub>, E<sub>T</sub>):

For rotary motion, mechanical misalignment in the radial and tangential directions relative to the codewheel.

### Angular Misalignment Error

(E<sub>A</sub>): angular misalignment of the sensor in relation to the tangential direction. This applies for both rotary and linear motion.

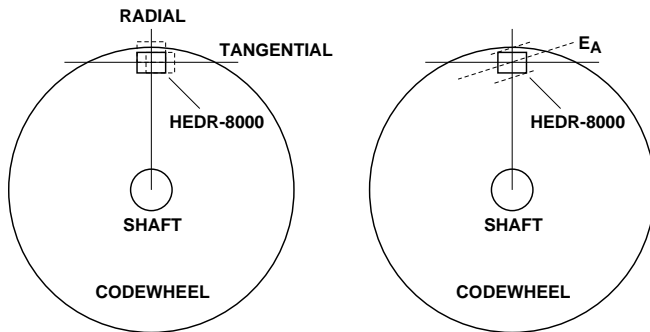

## Output Waveforms

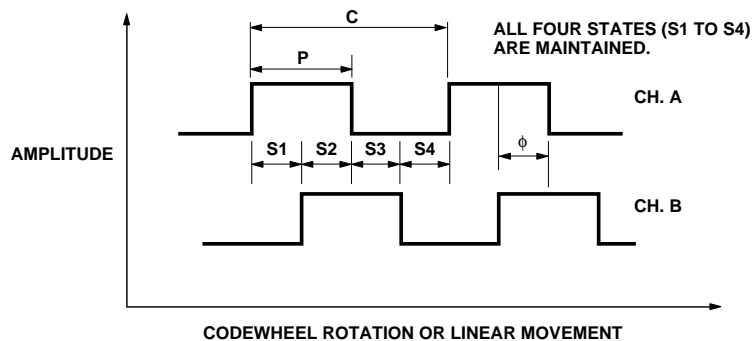

## Absolute Maximum Ratings

Storage Temperature, $T_S$	-40°C to 85°C
Operating Temperature, $T_A$	-10°C to 85°C
Supply Voltage, $V_{CC}$	-0.5 V to 7 V
Output Voltage, $V_O$	-0.5 V to $V_{CC}$
Output Current per Channel, $I_{OUT}$	-1.0 mA to 5 mA

Note: Exposure to extreme light intensity (such as from flashbulbs or spotlights) can cause permanent damage to device.

## Recommended Operating Conditions

Parameter	Symbol	Min.	Typ.	Max.	Units	Notes
Temperature	$T_A$	-10		85	°C	
Supply Voltage	$V_{CC}$	4.5	5.0	5.5	Volts	Ripple < 100 mVp-p
LED Current	$I_{LED}$	13	15	18	mA	See "Current Limiting Resistor for LED"
Load Capacitance	$C_L$			100	pF	2.7 K $\Omega$ Pull-Up
Count Frequency	f			15	kHz	Velocity (rpm) x N/60
Radial Misalignment	$E_R$			$\pm 0.38$ ( $\pm 0.015$ )	mm (in.)	
Tangential Misalignment	$E_T$			$\pm 0.38$ ( $\pm 0.015$ )	mm (in.)	
Angular Misalignment	$E_A$		0	$\pm 1.5$	deg.	
Codewheel or Codestrip Gap	G	1.52 (0.060)	2.03 (0.080)	2.54 (0.100)	mm (in.)	HEDR-8000 HEDR-8010
	G	1.02 (0.040)	1.52 (0.060)	2.03 (0.080)	mm (in.)	HEDR-8100
Codewheel or Codestrip Specular Reflectance	$R_f$	60%				As Measured on TMA $\mu$ scan Scope (see Note 1)
Codewheel/Codestrip Tilt	$C_T$		0	1	deg.	
Codewheel/Codestrip Resolution	LPmm (LPI)	2.76 (70)		2.95 (75)	lines/mm (lines/in.)	HEDR-8000 HEDR-8010
	LPmm (LPI)		5.91 150		lines/mm (lines/in.)	HEDR-8100

### Note:

1. Contact factory for more information regarding measurement of specular reflectance.

## Encoding Characteristics

Encoding Characteristics over the Recommended Operating Conditions and Mounting Conditions.

Parameter	Symbol	Typical	Maximum	Units	Notes
Pulse Width Error	$\Delta P$	15	55	°e	HEDR-8010
Pulse Width Error (Ch.A,Ch.B)	$\Delta P$	16	75	°e	HEDR-8100
Phase Error	$\Delta\phi$	10	60	°e	HEDR-8100
Pulse Width Error (Ch.A,Ch.B)	$\Delta P$	15,25	55,75	°e	HEDR-8000
Phase Error	$\Delta\phi$	12	60	°e	HEDR-8000

### Note:

Typical Value was obtained at typical condition. Maximums were obtained over all range of recommended operating condition and mounting condition.

## Electrical Characteristics

Electrical Characteristics over Recommended Operating Conditions. Typical Values at 25°C.

Parameter	Symbol	Min.	Typ.	Max.	Units	Notes
Supply Current	$I_{CC}$		2.2	5.0	mA	
High Level Output Voltage	$V_{OH}$	2.4			V	$I_{OH} = -40 \mu\text{A min.}$
Low Level Output Voltage	$V_{OL}$			0.4	V	$I_{OL} = 3.86 \text{ mA}$
Rise Time	$t_r$		150	200	ns	$C_L = 25 \text{ pF}$ $R_L = 2.7 \text{ K}\Omega$
Fall Time	$t_f$		50	60	ns	

## Current Limiting Resistor for LED

A resistor to limit current to the LED is required. The recommended value is  $220 \Omega (\pm 10\%)$  and should be placed in series between the 5 V supply and pin 8 of the device ( $V_{LED}$ ). This will result in an LED current of approximately 15 mA.

## Recommended Codewheel and Codestrip Characteristics

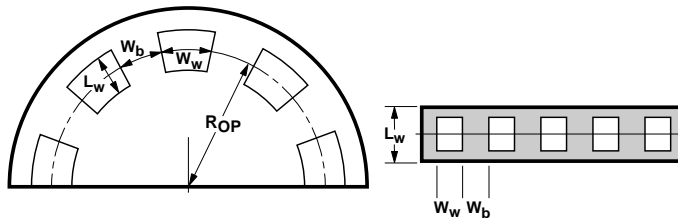

Parameter	Symbol	Min.	Max.	Units	Notes
Window/Bar Ratio	$W_w/W_b$	0.9	1.1		
Specular Reflectance	$R_f$	60	85		Reflective Bars
		–	10		Non-reflective Bars
Line Density	LPmm (LPI)	2.76 (70)	2.95 (75)	lines/mm (lines/inch)	HEDR-8000 HEDR-8010
	LPmm (LPI)	5.91 (150)	7.09 (180)	lines/mm (lines/inch)	HEDR-8100
Window Length	$L_w$	1.80 (0.071)	2.31 (0.091)	mm (inches)	mm (inches)

Contact factory for further information on compatible codewheel and codestrips.

## Mounting Conditions

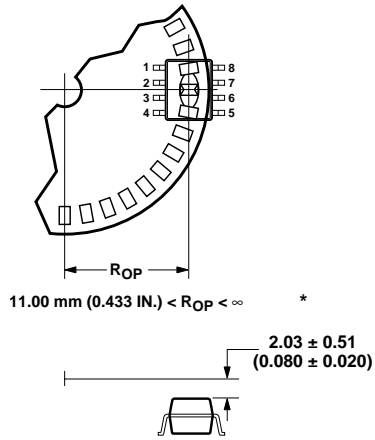

\*These dimensions are for HEDR-8000.  
Please refer to "Recommended Operating Conditions" table for HEDR-8100.

**RECOMMENDATION: Please refer to Application Note 1079: Design and Performance Considerations with HEDR-8000 for additional product information.**

## IR Soldering Conditions

The following recommended IR soldering profile meets the specifications of the Electronic Industries Association of Japan (EIAJ):

1.  $150 \pm 10^\circ\text{C}$  for  $90 \pm 30$  seconds
2. Greater than  $200^\circ\text{C}$  for  $30 \pm 10$  seconds
3.  $230^\circ\text{C} \pm 5^\circ\text{C}$  for  $10 \pm 1$  second

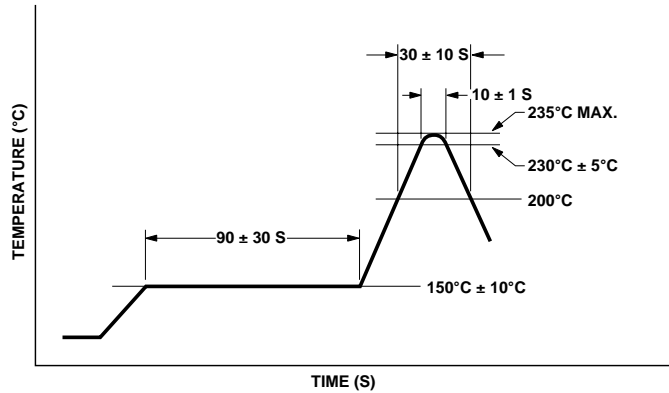

## Ordering Information

### A. Modules

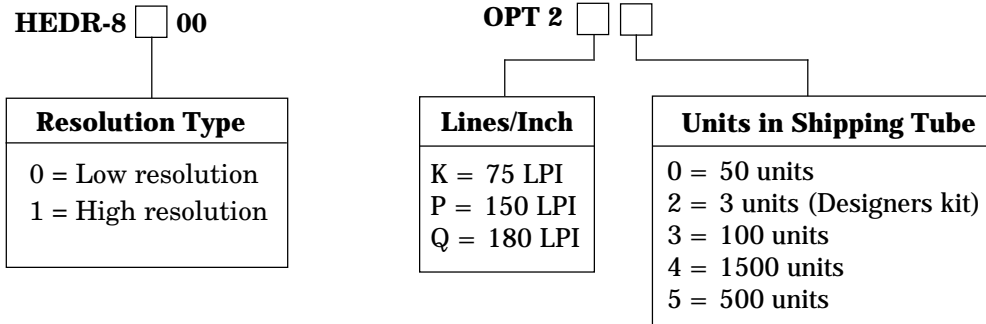

	0	2	3	4	5
HEDR-8000#2K	*	*	*	*	
HEDR-8100#2P	*	*	*	*	*
HEDR-8100#2Q				*	*
HEDR-8010#2K			*		

### B. Codewheel: reflective

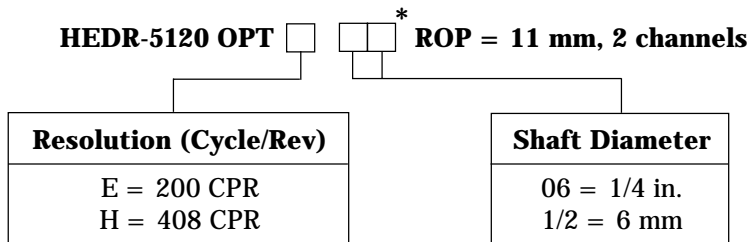

		06	12
HEDR-5120#	E	*	
	H	*	*

In order to achieve the reflective codewheel resolution stated, refer below for suitable encoder recommendation.

1. HEDR-5120#E<sub>xx</sub>, 200CPR to be used with option K, 75LPI of the encoder.
2. HEDR-5120#H<sub>xx</sub>, 408CPR to be used with option P, 150LPI of the encoder.

For product information and a complete list of distributors, please go to our website: [www.avagotech.com](http://www.avagotech.com)

Avago, Avago Technologies, and the A logo are trademarks of Avago Technologies, Pte. in the United States and other countries.  
Data subject to change. Copyright © 2006 Avago Technologies Pte. All rights reserved. Obsoletes 5988-5310EN  
5988-9452EN May 9, 2006

