

PYR 5008 and 7511 resistors

- For voltage balancing and/or discharge of electrolytic capacitors
- Fits capacitor diameters 50–90 mm
- Easy to mount

APPLICATION

Voltage balancing of series connected electrolytic can type capacitors and/or discharge purposes.

BASIC DESIGN

The PYR resistors are wire wound on a ceramic core and coated with high temperature silicone. The mounting brackets

are made of stainless steel and connected by two point spot welding.

SPECIFICATION

Standards	CECC 40201, MIL -R26E
Resistance range	10–47 k Ω
Resistance tolerance	+/- 5%
Rated voltage	700 VDC acc. to CECC 40201-003
Temperature range	-55 to +105°C

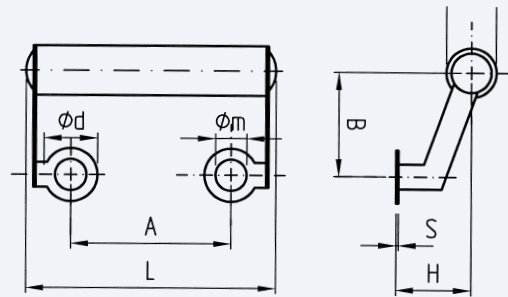

Dimensions table PYR (mm)

Type	A	L ± 1	d ± 2	m	B	H ± 1	S ± 1	D max	Weight approx (g)
PYR 5008	22.0*	40	10.6	6.3	21	15	0.4	10	9
PYR 7511	32.0	50	10.6	6.3	21	15	0.4	10	11

* Brackets are adjustable up to A = 28.5

Article table PYR

Article code	R (k Ω)*	P _{max} (W) 40°C	P _{max} (W) 85°C	P _{max} (W) 105°C	Fits cap. diameter
PYR 5008 / 47	47	10	8	7	50–65
PYR 7511 / 10	10	13	11	10	75–90
PYR 7511 / 18	18	13	11	10	75–90
PYR 7511 / 27	27	13	11	10	75–90
PYR 7511 / 47	47	13	11	10	75–90

* Other R values on request

MOUNTING DATA FOR THE ACCESSORIES

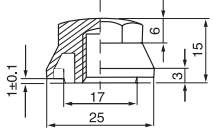
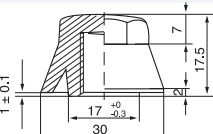
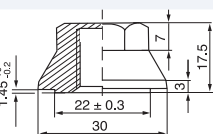
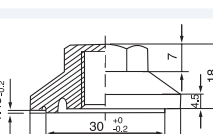
NYLON CAP NUTS	Mounting hole mm (min)	Max chassis thickness (mm)	Width of jaws (mm)	Creepage distance (mm)	Test voltage 50–60 Hz 1 min (KVAC)	Max tightening torque (NM)	Capacitor diameter (mm)
 <p>PYB 7033, M8</p>	Ø 17.5	5	17	4.5	2.5	3	Ø = 35
 <p>PYB 7026, M12</p>	Ø 17.5	5	19	2.5	2,5	8	Ø > 35
 <p>PYB 7041, M12</p>	Ø 22.5	5	19	5	2.5	8	Ø > 35
 <p>PYB 7042, M12</p>	Ø 30.5	5	19	9	4	8	Ø > 35

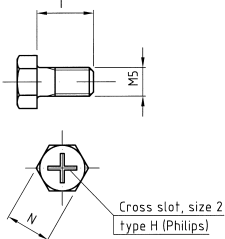
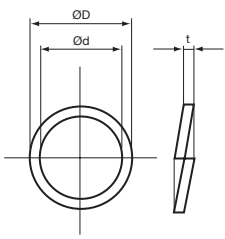
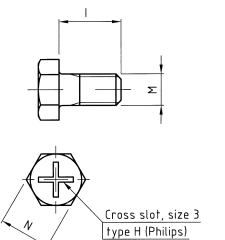
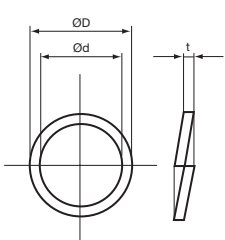
SCREWS STAINLESS STEEL	WASHERS STAINLESS STEEL	M	l	D	d	t	S	Max tightening torque (NM)
 <p>PYC 6750, M5</p>	 <p>PYC 7150, M5</p>	M5	10	8.7	5.1	1.2	10	3
 <p>PYC 6751, M6*</p>	 <p>PYC 6756, M6*</p>	M6	12	11.1	6.1	1.6	12	5 *

* M6 and M5 (max connector thickness 3 mm incl. washer)

CLIPS

DIMENSIONS mm MATERIAL Zinc plated steel

Horizontal Mounting

TYPE	CAN DIA	A	B	C	F
H1	25.0	40.0	22.3	12.8	10.0
H2	35.0	52.0	22.3	12.8	10.0

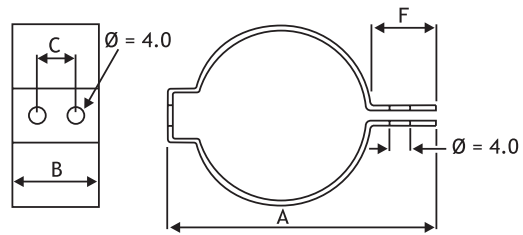

Vertical Mounting

TYPE	CAN DIA	A	B	C	F
V2	25.0	49.0	19.0	37.0	10.0
V3	35.0	58.0	19.0	45.0	9.0
V9	40.0	65.0	19.0	52.4	9.5

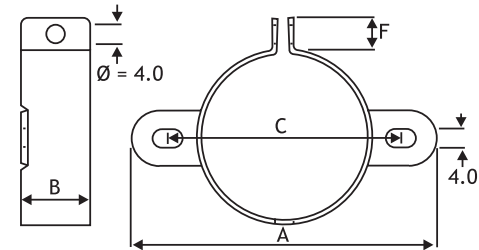

TYPE	CAN DIA	A	B	C	E	F
V4	51.0	75.0	25.4	64.0	5.0	10.0
V6	45.0	69.5	17.4	58.0	4.0	10.0
V8	63.5	88.9	25.4	77.5	5.0	9.5
PYC6041	35	64	19	52	4.5	11.5

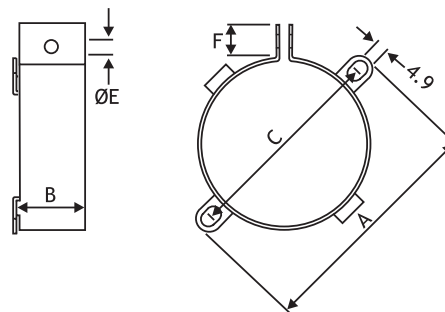

TYPE	CAN DIA	A	B	C	D	F
UTE2736	35.0	63.0	12.2	54.0	17.2	9.0

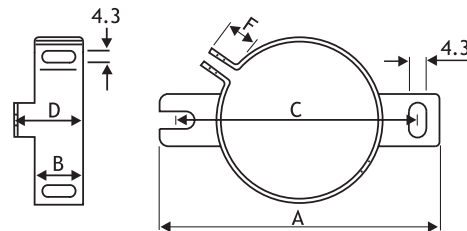

TYPE	CAN DIA	A	B	C	D	E	F	G
V10	65.0	90.0	40.0	30.0	5.0	4.5	-	10
V11	76.0	103.0	45.5	30.0	5.0	4.5	-	10
V90	90.0	116.0	53.5	30.0	5.0	4.5	-	10
UTE2737	50.0	75.5	33.5	27.0	4.3	4.3	39.5	10
UTE2738	65.0	88.5	39.0	27.0	4.3	4.3	45.0	10
UTE2739	72.0	97.0	44.0	28.0	4.3	4.3	50.0	10
PYC6042	50	78	32.5	30	5.5	4.5	39	12
PYC6043	65	90.5	38	36	5.5	4.5	44	12
PYC6044	75	100.5	43	36	5.5	4.5	49	12
PYC6045	90	115.5	50.5	36	5.5	4.5	56.5	12

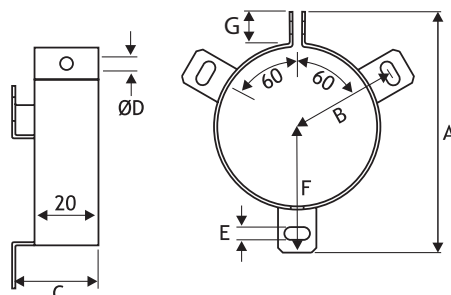

Note

When using mounting clamps care should be taken not to obscure any safety vent in the can. Delivered without bolts and nuts for mounting.

MOUNTING KITS

INSULATED VERSION

M8 Stud (M12 Stud)

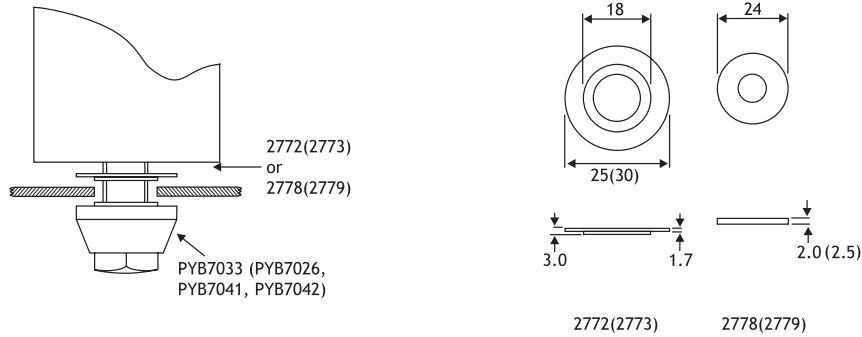

NON-INSULATED VERSION

M8 Stud (M12 Stud)

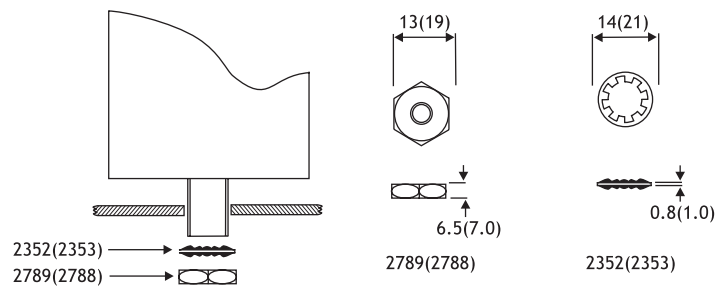

Dimensions mm. All the above accessories may be ordered individually using the part number shown, or as kits using the kit part numbers shown below.

Kit Contents and Ordering Information

STANDARD KITS

Part code	Description	Kit order number			
		2740	2741	2782	2785
2352	Steel washer M8	-	-	•	-
2353	Steel washer M12	-	-	-	•
2772	Stepped poly washer M8	•	-	-	-
2773	Stepped poly washer M12	-	•	-	-
2778	Plain poly washer M8	•	-	-	-
2779	Plain poly washer M12	-	•	-	-
2788	Steel nut M12	-	-	-	•
2789	Steel nut M8	-	-	•	-
PYB7033	Nylon nut M8	•	-	-	-
PYB7026	Nylon nut M12	-	•	-	-

Kit description

Insulated M8

Insulated M12

Non-insulated M8

Non-insulated M12

SPECIAL KITS

Part code	Description	Kit order number				
		2690	2691	2692	2693	2695
2352	Steel washer M8	-	-	•	-	-
2353	Steel washer M12	•	-	-	•	-
2772	Stepped poly washer M8	-	•	•	-	-
2773	Stepped poly washer M12	•	-	-	•	•
2778	Plain poly washer M8	-	•	•	-	-
2779	Plain poly washer M12	-	-	-	•	•
2788	Steel nut M12	•	-	-	•	•
2789	Steel nut M8	-	•	•	-	-
PYB7041	Nylon nut M12	-	-	-	-	-
PYB7042	Nylon nut M12	-	-	-	-	-