

## Product Dimensions

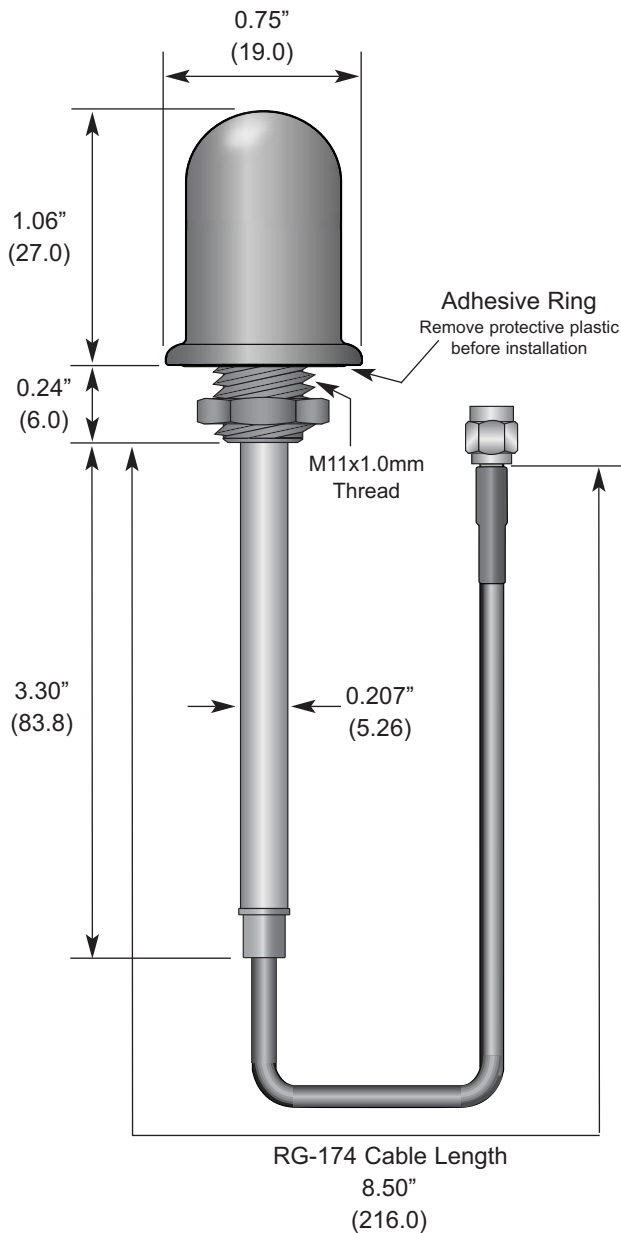

## Description



The WRT Series antenna is ideally suited for applications such as wireless vending, security, traffic, or power equipment which require an unobtrusive, tamper-resistant antenna solution. The small 27mm radome installs through a small hole on the product and is anchored by a threaded base. An adhesive foam compression ring is used to resist the elements. The antenna also features an integral counterpoise, which reduces the need for a proximity ground plane.

The antenna's coax feed is available with SMA or RP-SMA terminations. Alternate coax lengths, connectors and custom colors are available for volume OEM customers.

## Features

- Low cost
- Unobtrusive
- Tamper resistant
- Integral counterpoise
- Indoor / outdoor
- Adhesive or permanent mount

## Electrical Specifications

- |                           |                     |
|---------------------------|---------------------|
| • Center Freq.            | 418MHz              |
| • Recommended Oper. Freq. | 409-426MHz          |
| • VSWR                    | <1.9 typ. at center |
| • Impedance               | 50 ohms             |
| • Connector               | RP-SMA or SMA       |

Electrical specifications and plots measured on 24" x 24" reference ground plane

## Ordering Information

- ANT-418-WRT-RPS (with RP-SMA connector)
- ANT-418-WRT-SMA (with SMA connector)

## VSWR Graph

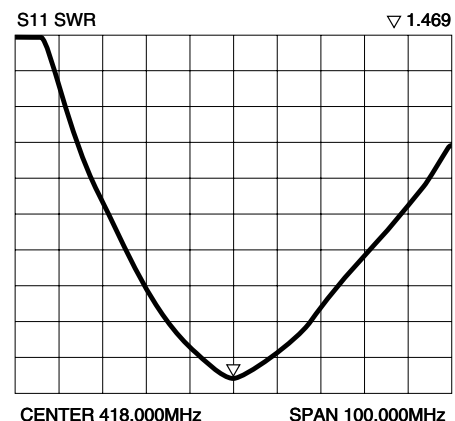

Typical VSWR

