







T1/E1/CEPT/ISDN-PRI INTERFACE MODULES

Dual Surface Mount Transformer Modules, 1500Vrms, Extended Temperature Range



-  Optimized for enhanced EMC performance
-  Extended temperature range
-  Dual SMT package contains transformers with Common Mode Chokes on both transmit and receive channels
-  Models matched to leading transceiver ICs
-  Patented Interlock Base construction for high reliability
-  UL1950 approved

Electrical Specifications @ 25°C

RoHS-5 Compliant Part No.	RoHS-6 Compliant Part No.	Turns Ratio ² (Pri:Sec ± 2%)	Secondary OCL @ 25°C (mH MIN)	L _L (μH MAX)	C _{w/w} (pF MAX)	DCR Pri (Ω MAX)	Package/ Schematic	Primary Pins
EXTENDED TEMPERATURE RANGE MODELS¹ – OPERATING TEMPERATURE -40°C TO +85°C								
T1207	T1207NL	1CT:2CT & 1CT:2CT	1.20	.60	25	.60	AN/1	1-3, 4-6
T1208	T1208NL	1CT:2CT & 1CT:1.36CT	1.20	.60	30	.70	AN/1	1-3, 4-6
T1209	T1209NL	1CT:1.15CT & 1CT:2CT	1.20	.60	35	.80	AN/1	1-3, 4-6
T1210	T1210NL	1CT:1.26CT & 1CT:2CT	1.20	.60	30	.80	AN/1	1-3, 4-6
T1220	T1220NL	1CT:1CT & 1CT:1CT	1.20	.60	35	.90	AN/1	1-3, 4-6
T1211	T1211NL	1CT:1.15CT & 1CT:1.15CT	1.20	.60	35	.80	AN/1	1-3, 4-6
T1212	T1212NL	1CT:1CT & 1CT:2CT	1.20	.60	35	.90	AN/1	1-3, 4-6
T1213	T1213NL	1CT:1.15CT & 1CT:1CT	1.20	.60	35	.90	AN/1	1-3, 4-6
T1214	T1214NL	1CT:1.36CT & 1CT:1.36CT	1.20	.60	30	.80	AN/1	1-3, 4-6
T1215	T1215NL	1CT:1.41CT & 1CT:1.41CT	1.20	.60	30	.70	AN/1	1-3, 4-6
T1216	T1216NL	1CT:2.3CT & 1CT:2CT	1.20	.60	25	.60	AN/1	1-3, 4-6
T1217	T1217NL	1CT:2.42CT & 1CT:2.42CT	1.20	.60	25	.60	AN/1	1-3, 4-6
T1218	T1218NL	1CT:1CT & 1CT:1.36CT	1.20	.60	35	.90	AN/1	1-3, 4-6
T1219	T1219NL	1CT:2.4CT & 1CT:1CT	1.20	.60	35	.90	AN/1	1-3, 4-6

NOTE: Optional Tape & Reel packaging can be ordered by adding a "T" suffix to the part number (ex: T1207T and T1207NLT).

Mechanical

Schematics

AN

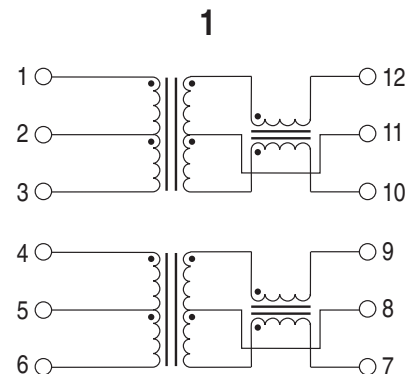

Dimensions: $\frac{\text{Inches}}{\text{mm}}$
Unless otherwise specified, all tolerances are $\pm \frac{.010}{0,25}$

Weight4.0 grams
Tape & Reel250/reel
Tube30/tube

T1/E1/CEPT/ISDN-PRI INTERFACE MODULES

Dual Surface Mount Transformer Modules, 1500Vrms, Extended Temperature Range



Notes From Tables

- Extended Temperature Range Models** — For extended temperature range transformers (-40°C to +85°C operating temperature range), OCL (Open Circuit Inductance) is specified at both -40°C and +25°C. At -40°C, OCL is 600 µH minimum. All other parameters are specified at +25°C only. Standard temperature range is 0°C to +70°C.
- Turns ratio is specified primary: secondary (CT = Center Tap).
- Standard packaging for the surface mount package is anti-static tubes. Optional Tape & Reel packaging can be ordered by adding a "T" suffix to the part number, (i.e. T1220T).
- Return Loss** — ITU-T G.703 and European national regulatory documents specify minimum return loss levels. The transformers will allow these limits to be complied within the situations where they are applicable.

Frequency	50-100kHz	100kHz-2MHz	2-3MHz
Return Loss			
XMIT	9 dB	15dB	11dB
RCV	12dB	18dB	14dB

Application Notes

- ET Product** — All coils have an ET product of 10V-µsec minimum.
- Flammability** — Materials used in the products are recognized as UL94-VO approved. Products meet the requirements of IEC 695-2-2 (Needle Flame Test).
- Balance Characteristics** — The transformers meet the requirements for longitudinal balance of FCC part 68.
- Common Mode Rejection Ratio** — the CMRR for all transformers is better than 50dB at 1MHz. A typical test circuit is shown below.
- Crosstalk Attenuation** — In the packages which contain transmit and receive transformers side by side, sufficient crosstalk attenuation is achieved by the inherent characteristics of the toroid cores as well as by their proper positioning. The crosstalk attenuation is typically 65dB or better. This result was established with the test circuit shown below.
- Surge Voltage Capability** — All transformers and chokes meet surge voltage tests according to the most stringent regulatory documents, when used with the proper voltage and current suppression devices:
 - Metallic Voltage: 800V peak, 10/560µsec
 - Longitudinal Voltage: 2,400V peak, 10/700µsec
- Isolation Voltage** — 100% of transformers are tested during production to the specified isolation voltage level.
- General Information** — The transformers are specifically designed for use in 1.544Mbps (T1), 2.048Mbps (CEPT) and ISDN Primary rate (PRI) interface applications. They are matched to the majority of the line interface transceiver ICs currently available. Use of the proper transformer allows the interface circuit to comply with ITU-T G.703 and other standards regarding pulse waveform, return loss, and balance.
- Transformer Selection Guide** — Please contact Pulse Application Engineering or see our website for the latest Pulse Transformer Selection Guide.

For More Information:

Pulse Worldwide Headquarters

12220 World Trade Dr.
San Diego, CA 92128
U.S.A.

www.pulseeng.com

TEL: 858 674 8100

FAX: 858 674 8262

Pulse Europe

Einsteinstrasse 1
D-71083 Herrenberg
Germany

Tel: 49 7032 7806 116

Fax: 49 7032 7806 135

Pulse China Headquarters

No. 1
Industrial District
Changan, Dongguan
China

Tel: 86 769 85538070

Fax: 86 769 85538870

Pulse North China

Room 1503
XinYin Building
No. 888 YiShan Rd.
Shanghai 200233
China

Tel: 86 21 54643211/2

Fax: 86 21 54643210

Pulse South Asia

150 Kampong Ampat
#07-01/02
KA Centre
Singapore 368324

Tel: 65 6287 8998

Fax: 65 6280 0080

Pulse North Asia

No. 26
Kao Ching Rd.
Yang Mei Chen
Taoyuan Hsien
Taiwan, R. O. C.

Tel: 886 3 4641811

Fax: 886 3 4641911

Performance warranty of products offered on this data sheet is limited to the parameters specified. Data is subject to change without notice. Other brand and product names mentioned herein may be trademarks or registered trademarks of their respective owners.

© Copyright, 2006. Pulse Engineering, Inc. All rights reserved.

www.pulseeng.com

T660.B (6/06)