

1 | 2 | 3 | 4 | 5 | 6

DESCRIPTION : ABOVE PCB, DECK AND PUSH ROD LOCATION ARE AS VIEW BY USER.

PRODUCT NO.	PUSH ROD LOCATION	STAND-OFF HEIGHT	MATING RECEPTACLE ⓑ	P.C.B SIDE	RECOMMENDED P.C.B LAYOUT	MOUNT STYLE TO PCB AND PUSH ROD SIDE
Ⓐ 73704-*****						
000CA/000CALF	RIGHT	0.0	100 POSITIONS (2x50) 0.8mm RECEPTACLE PART NO. 73277-101000 73277-101000LF	ABOVE	SEE DRAWING NO.: TA-1050	
020CA/020CALF	RIGHT	2.0				
022CA/022CALF	RIGHT	2.2				
040CA/040CALF	RIGHT	4.0				
043CA/043CALF	RIGHT	4.3				
050CA/050CALF	RIGHT	5.0				
100CA/100CALF	LEFT	0.0				
120CA/120CALF	LEFT	2.0				
122CA/122CALF	LEFT	2.2				
140CA/140CALF	LEFT	4.0				
143CA/143CALF	LEFT	4.3				
150CA/150CALF	LEFT	5.0				
522CA/522CALF	RIGHT	2.2	100 POSITIONS (2x50) 0.8mm RECEPTACLE PART NO. 73277-101000 73277-101000LF	BELOW	SEE DRAWING NO.: TA-1050	
540CA/540CALF	RIGHT	4.0				
543CA/540CALF	RIGHT	4.3				
550CA/550CALF	RIGHT	5.0				
622CA/622CALF	LEFT	2.2				
640CA/640CALF	LEFT	4.0				
643CA/643CALF	LEFT	4.3				
650CA/650CALF	LEFT	5.0				

ORDERING INFORMATION

THREADED INSERT ASSEMBLED BY BERG			
NAME	PART NO.		Q'TY
Ⓐ EJECT HEADER ASS'Y	73704-*****	73704-*****LF	1
ⓑ MATING RECEPTACLE	73277-101000	73277-101000LF	1

mat'l code	tolerance unless otherwise specified	CUSTOMER COPY		www.fciconnect.com
rev. ecn no. dr date	linear	± 0.30	projection	title CARDBUS EJ HEADER SMT, TYPE 1/2/3
H N05-0088 W B03/24/05	angles	± 2°		product family PCMCIA code
C T80400 W L09/08/98	dr WENDY CHEN05/08/97	unit	mm/inch	size dwg no.
D T80440 W L10/06/98	engr JOSEPH HSIA05/08/97	scale	1:1	A3 73704
E T90178 W L06/04/98	chr JOSEPH HSIA05/08/97	sheet		1 of 11
F T00104 W L04/14/00	appd JENN TSAO05/08/97	index		
G T20327 W L11/13/02				

PDM: Rev:H STATUS Released Printed: Oct 12, 2010

All rights strictly reserved. Reproduction or issue to third parties in any form or by any means, electronic or mechanical, including photocopying, recording, or by any information storage and retrieval system, is prohibited without written authority from the proprietor. Copyright BERG ELECTRONICS BV

1 | 2 | 3 | 4 | 5 | 6

DESCRIPTION : ABOVE PCB, DECK AND PUSH ROD LOCATION ARE AS VIEW BY USER.

PRODUCT NO.	PUSH ROD LOCATION	STAND-OFF HEIGHT	MATING RECEPTACLE ⓑ	P.C.B SIDE	RECOMMENDED P.C.B LAYOUT	MOUNT STYLE TO PCB AND PUSH ROD SIDE
Ⓐ 73704-*****						
000CAS/000CASLF	RIGHT	0.0	100 POSITIONS (2x50) 0.8mm RECEPTACLE PART NO. 73277-101000 73277-101000LF	ABOVE	SEE DRAWING NO.: TA-1050	
020CAS/020CASLF	RIGHT	2.0				
022CAS/022CASLF	RIGHT	2.2				
040CAS/040CASLF	RIGHT	4.0				
043CAS/043CASLF	RIGHT	4.3				
050CAS/050CASLF	RIGHT	5.0				
100CAS/100CASLF	LEFT	0.0				
120CAS/120CASLF	LEFT	2.0				
122CAS/122CASLF	LEFT	2.2				
140CAS/140CASLF	LEFT	4.0				
143CAS/143CASLF	LEFT	4.3	100 POSITIONS (2x50) 0.8mm RECEPTACLE PART NO. 73277-101000 73277-101000LF	BELOW	SEE DRAWING NO.: TA-1050	
150CAS/150CASLF	LEFT	5.0				
522CAS/522CASLF	RIGHT	2.2				
540CAS/540CASLF	RIGHT	4.0				
543CAS/543CASLF	RIGHT	4.3				
550CAS/550CASLF	RIGHT	5.0				
622CAS/622CASLF	LEFT	2.2				
640CAS/640CASLF	LEFT	4.0				
643CAS/643CASLF	LEFT	4.3				
650CAS/650CASLF	LEFT	5.0				

ORDERING INFORMATION

THREADED INSERT ASSEMBLED BY BERG			
NAME	PART NO.		Q'TY
Ⓐ EJECT HEADER ASS'Y	73704-*****	73704-*****LF	1
ⓑ MATING RECEPTACLE	73277-101000	73277-101000LF	1

mat'l code	tolerance unless otherwise specified	CUSTOMER COPY		www.fciconnect.com
rev. ecn no. dr date	linear ± 0.30	projection		title
H	angles ± 2°		size	SMT, TYPE 1/2/3
	dr WENDY CHEN 05/09/97	unit	product family :	PCMCIA
	engr JOSEPH HSIAO 05/09/97	mm/inch	size	dwg no.
	chr JOSEPH HSIAO 05/09/97	scale	A3	73704
	appd JENN TSAO 05/09/97	1:1		code
sheet	revision			TWN
index	sheet			2 of

PDM: Rev:H STATUS Released Printed: Oct 12, 2010

1 | 2 | 3 | 4 | 5 | 6

Tous droits strictement réservés. Reproduction ou communication à des tiers interdite sans autorisation écrite du propriétaire.
 All rights strictly reserved. Reproduction or communication to third parties in any form without the written authority of the proprietor.
 FCI
 FCI
 FCI

PRODUCT NO.
SEE TABLE A

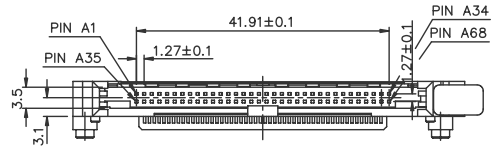
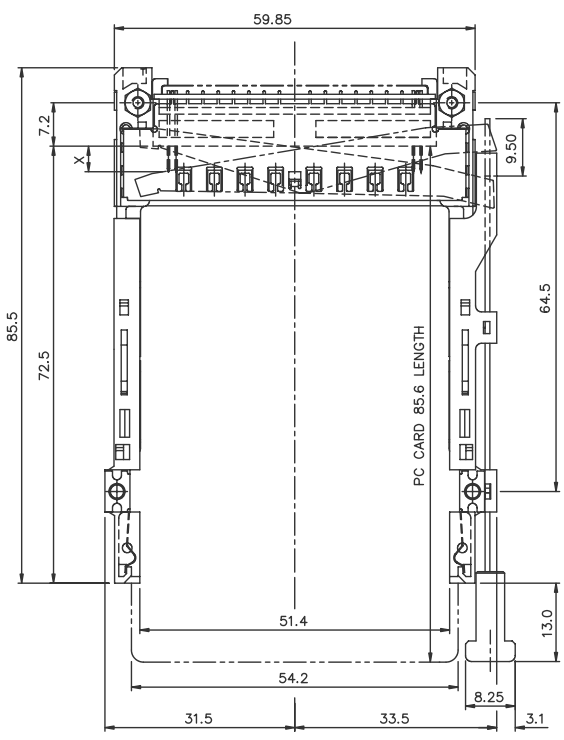
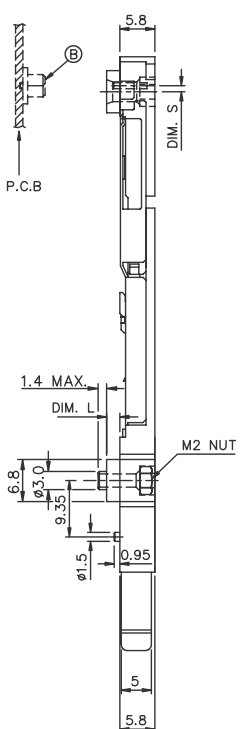

P/N : 73704-0**CA/0**CALF
(ABOVE P.C.B/LAYOUT SEE TA-1050)

TABLE A

PRODUCT NO.	STAND-OFF(DIM. L)	DIM. S
73704-050CA/050CALF	5.0 mm	-0.3
-043CA/043CALF	4.3 mm	-0.3
-040CA/040CALF	4.0 mm	-0.3
-022CA/022CALF	2.2 mm	1.0
-020CA/020CALF	2.0 mm	1.0
-000CA/000CALF	NONE	5.5

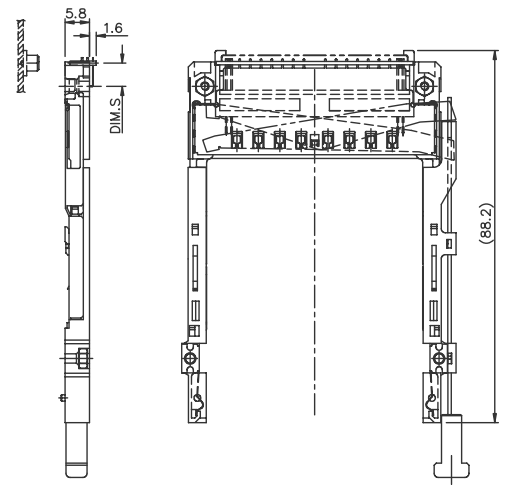

P/N : 73704-000CA/000CALF
(ABOVE P.C.B/LAYOUT SEE TA-1050)

mat'l code		tolerance unless otherwise specified		CUSTOMER COPY		 www.fciconnect.com	
rev. H	ecn no.	dr	date	linear	± 0.30	projection	title
				angles	± 2°		CARDBUS EJ HEADER SMT, TYPE 1/2/3
				dr	WENDY CHEN 02/11/98	unit	product family : PCMCIA
				enqr	JOSEPH HSIA 02/11/98	mm/inch	code
				chr	JOSEPH HSIA 02/11/98	scale	TWN
				appd	JENN TSAO 02/11/98	1.5:1	sheet
sheet index	revision						73704
	3						3 of

Tous droits strictement réservés. Reproduction ou communication à des tiers interdite sans autorisation écrite du propriétaire.
 Brevets de reproduction BERG ELECTRONICS INC.



All rights strictly reserved. Reproduction or issue to third parties in any form or by any means, without written authority from the proprietor.
 Copyright BERG ELECTRONICS INC.

PRODUCT NO.
SEE TABLE A

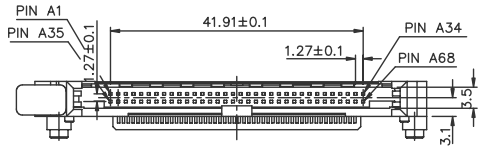
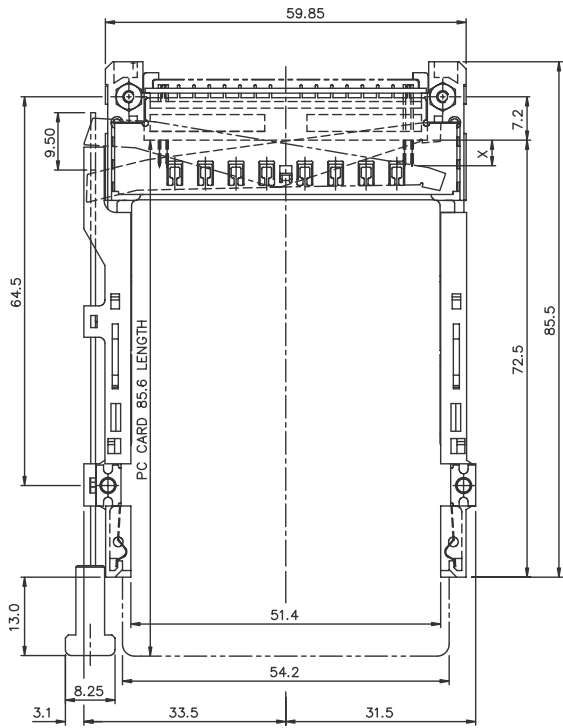

P/N : 73704-1**CA/1**CALF
(ABOVE P.C.B/LAYOUT SEE TA-1050)

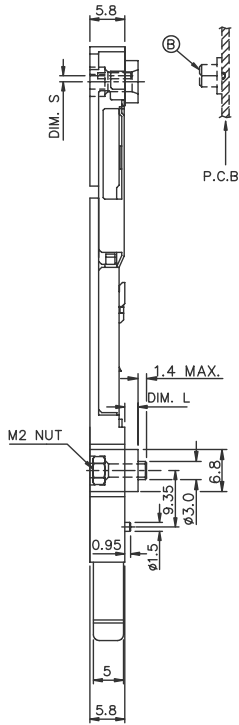
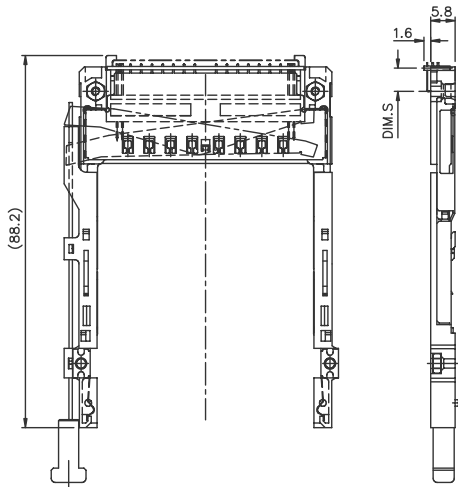

TABLE A

PRODUCT NO.	STAND-OFF(DIM. L)	DIM. S
73704-150CA/150CALF	5.0 mm	-0.3
-143CA/143CALF	4.3 mm	-0.3
-140CA/140CALF	4.0 mm	-0.3
-122CA/122CALF	2.2 mm	1.0
-120CA/120CALF	2.0 mm	1.0
-100CA/100CALF	NONE	5.5



P/N : 73704-100CA/100CALF
(ABOVE P.C.B/LAYOUT SEE TA-1050)

mat'l code	tolerance unless otherwise specified	CUSTOMER COPY	www.fciconnect.com	
rev. ecn no. dr date	linear ± 0.30	projection	title CARDBUS EJ HEADER SMT, TYPE 1/2/3	
	angles ± 2°		product family : PCMCIA	code TWN
dr WENDY CHEN 02/11/98	unit mm/inch	scale 1.5:1	size dwg no. 73704	sheet 4 of 4
enqr JOSEPH HSIA 02/11/98				
chr JOSEPH HSIA 02/11/98				
appd JENN TSAO 02/11/98				
sheet index	revision sheet			

PDM: Rev:H STATUS Released Printed: Oct 12, 2010

Tous droits strictement réservés. Reproduction ou communication à des tiers interdite sans autorisation écrite du propriétaire.
 All rights strictly reserved. Reproduction or communication to third parties in any form without the written authority from the proprietor.
 Copyright BERG ELECTRONICS by

All rights strictly reserved. Reproduction or communication to third parties in any form without the written authority from the proprietor.
 Copyright BERG ELECTRONICS by

FCI

PRODUCT NO.
SEE TABLE A

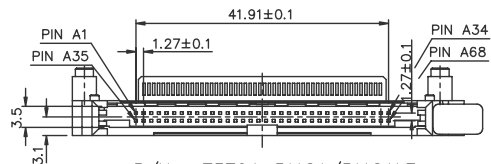
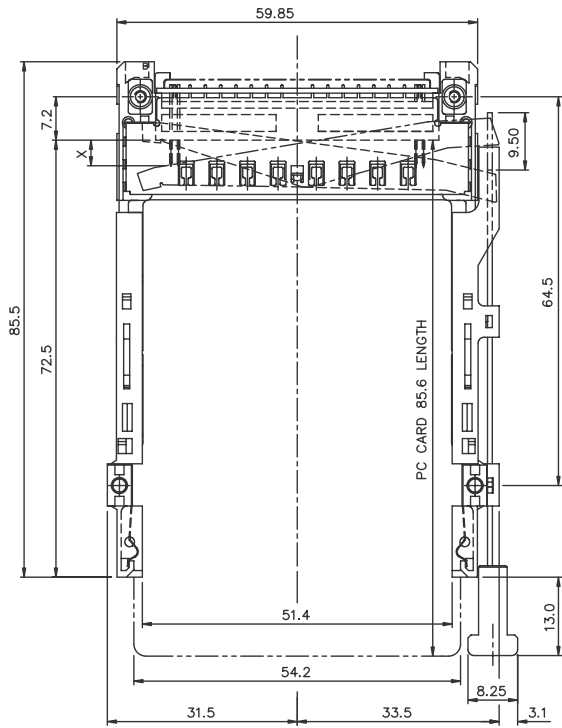
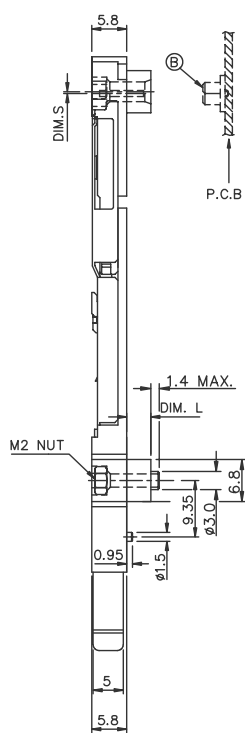

P/N : 73704-5**CA/5**CALF
(ABOVE P.C.B/LAYOUT SEE TA-1050)

TABLE A

① PRODUCT NO.	STAND-OFF(DIM. L)	DIM. S
73704-550CA/550CALF	5.0 mm	-0.3
-543CA/543CALF	4.3 mm	-0.3
-540CA/540CALF	4.0 mm	-0.3
-522CA/522CALF	2.2 mm	5.5

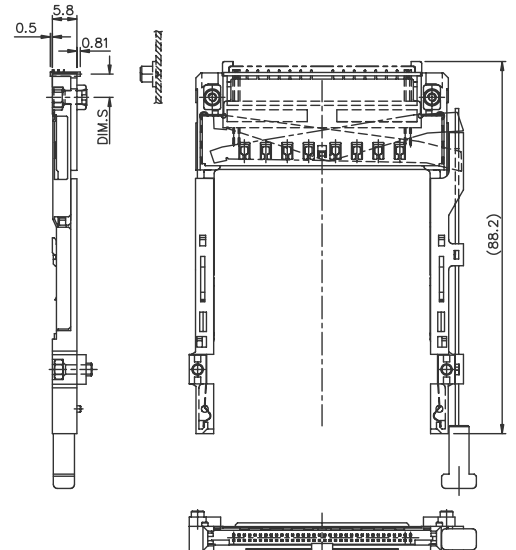

P/N : 73704-522CA/522CALF
(ABOVE P.C.B/LAYOUT SEE TA-1050)

mat'l code	tolerance unless otherwise specified	CUSTOMER COPY	 www.fciconnect.com	title CARDBUS EJ HEADER SMT, TYPE 1/2/3	product family : PCMCIA code TWN
rev. H	linear ± 0.30	projection			
ecn no.	angles ± 2°	unit mm/inch	scale 1.5:1		
dr	dr WENDY CHEN 05/09/97				
enr	enr JOSEPH HSIA 05/09/97				
chr	chr JOSEPH HSIA 05/09/97				
appd	appd JENN TSAO 05/09/97				
sheet index	revision sheet				

PDM: Rev:H STATUS Released Printed: Oct 12, 2010

Tous droits strictement réservés. Reproduction ou communication à des tiers sans autorisation écrite du propriétaire. Property of BERG ELECTRONICS. Droits de reproduction BERG ELECTRONICS by

All rights strictly reserved. Reproduction or issues to third parties in any form without the written authority from the proprietor. Property of BERG ELECTRONICS. Copyright BERG ELECTRONICS by

FCI

PRODUCT NO.
SEE TABLE A

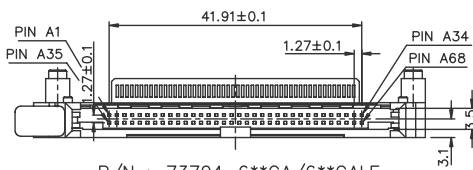
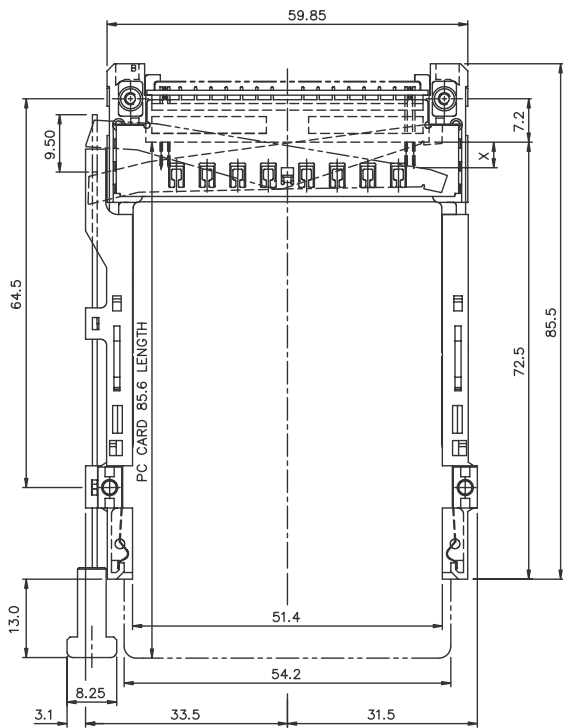

P/N : 73704-6**CA/6**CALF
(ABOVE P.C.B/LAYOUT SEE TA-1050)

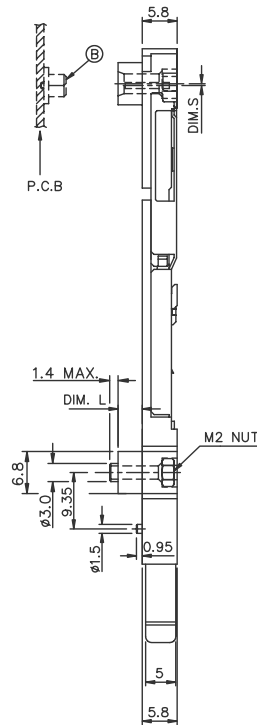
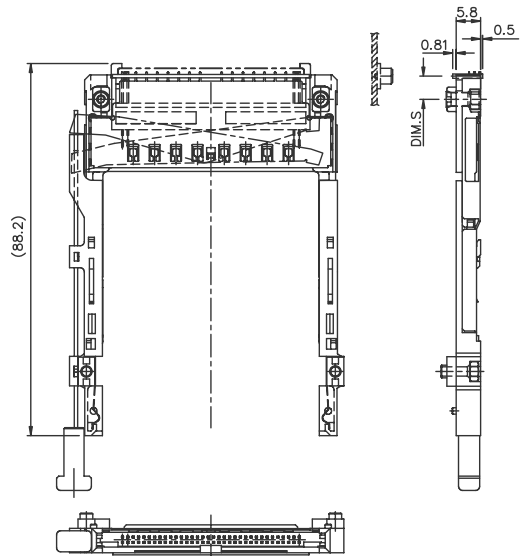

TABLE A

⊗ PRODUCT NO.	STAND-OFF(DIM. L)	DIM. S
73704-650CA/650CALF	5.0 mm	-0.3
-643CA/643CALF	4.3 mm	-0.3
-640CA/640CALF	4.0 mm	-0.3
-622CA/622CALF	2.2 mm	5.5



P/N : 73704-622CA/622CALF
(ABOVE P.C.B/LAYOUT SEE TA-1050)

mat'l code	tolerance unless otherwise specified	CUSTOMER COPY	 www.fciconnect.com
rev. H	ecn no. dr date	linear ± 0.30	
		angles ± 2°	title
		dr WENDY CHEN 05/09/97	unit
		enrg JOSEPH HSIA 05/09/97	mm/inch
		chr JOSEPH HSIA 05/09/97	product family : PCMCIA
		appd JENN TSAO 05/09/97	size
			dwg no.
sheet index	revision sheet	scale 1.5:1	A3
			73704
			code
			TWN
			sheet
			6 of 6

PDM: Rev:H STATUS Released Printed: Oct 12, 2010

Tous droits strictement réservés. Reproduction ou communication à des tiers sans autorisation écrite du propriétaire. FCI ELECTRONICS S.A. Droits de reproduction BERG ELECTRONICS bv

All rights strictly reserved. Reproduction or issue to third parties in any form without written authority from the proprietor. FCI ELECTRONICS S.A. Copyright BERG ELECTRONICS bv

PRODUCT NO.
SEE TABLE A

TABLE A

PRODUCT NO.	STAND-OFF(DIM. L)	DIM. S
73704-050CAS	5.0 mm	-0.3
-043CAS	4.3 mm	-0.3
-040CAS	4.0 mm	-0.3
-022CAS	2.2 mm	1.0
-020CAS	2.0 mm	1.0
-000CAS	NONE	5.5

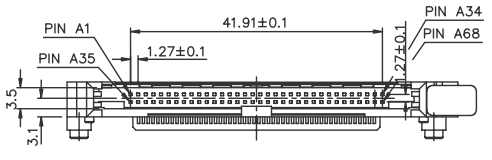
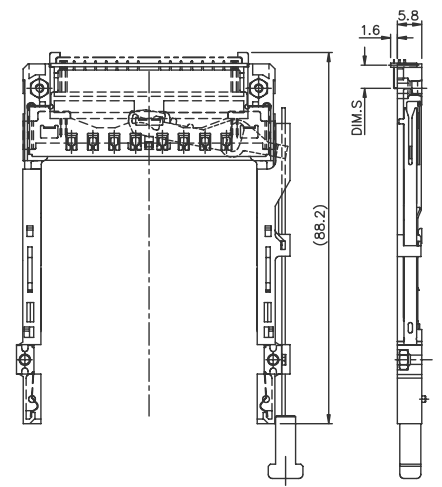
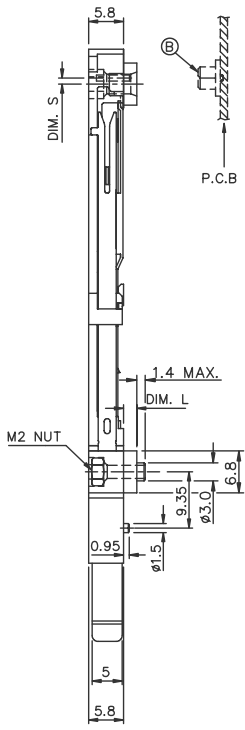
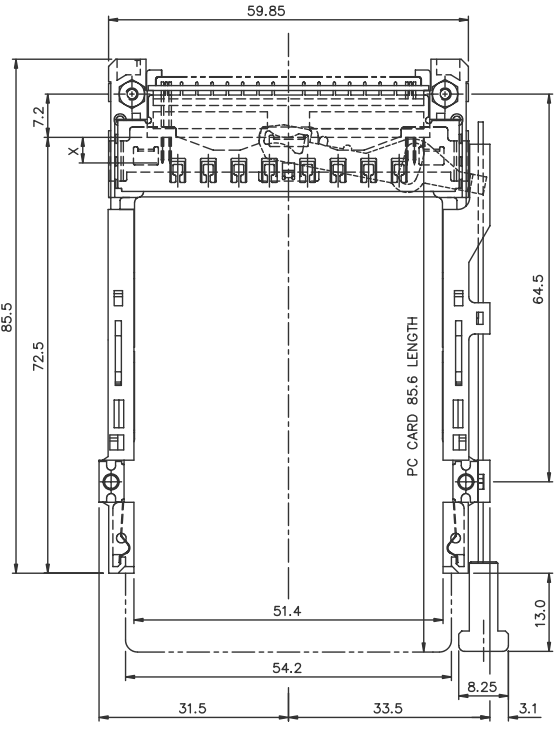

P/N : 73704-0**CAS/0**CASLF
(ABOVE P.C.B/LAYOUT SEE TA-1050)

P/N : 73704-000CAS/000CASLF
(ABOVE P.C.B/LAYOUT SEE TA-1050)

mat'l code		tolerance unless otherwise specified		CUSTOMER COPY		FCI		www.fciconnect.com	
rev.	ecn no.	dr	date	linear	± 0.30	projection	title CARDBUS EJ HEADER SMT, TYPE 1/2/3		
H				angles	± 2°		product family PCMCIA		
				dr	WENDY CHEN 05/04/99	unit	size		code
				engr	JOSEPH HSIA 05/04/99	mm/inch	73704		sheet
				chr	JOSEPH HSIA 05/04/99	scale	1.5:1		7 of
				appd	JENN TSAO 05/04/99				
sheet index	revision sheet								

PDM: Rev:H STATUS Released Printed: Oct 12, 2010

All rights strictly reserved. Reproduction or issue to third parties in any form or by any means, without written authority from the proprietor.
 Tous droits strictement réservés. Reproduction ou communication à des tiers sans autorisation écrite du propriétaire.
 Copyright BERG ELECTRONICS S.p.A.
 Droits de reproduction BERG ELECTRONICS S.p.A.

PRODUCT NO.
SEE TABLE A

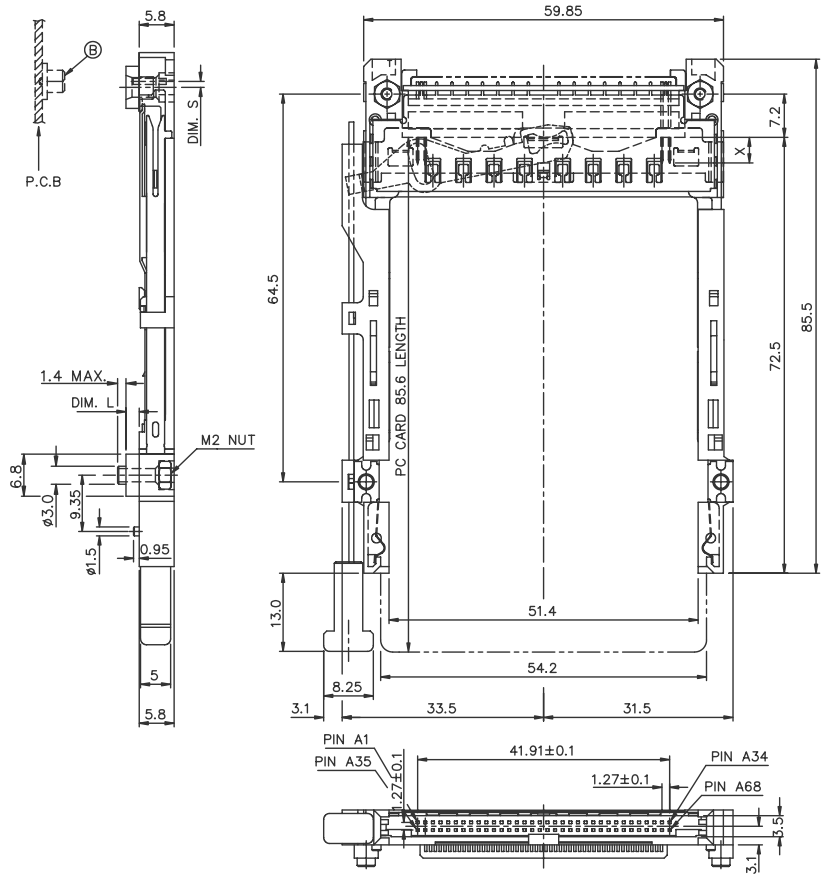

P/N : 73704-1**CAS/1**CASLF
(ABOVE P.C.B/LAYOUT SEE TA-1050)

TABLE A

⊕ PRODUCT NO.	STAND-OFF(DIM. L)	DIM. S
73704-150CAS/150CASLF	5.0 mm	-0.3
-143CAS/143CASLF	4.3 mm	-0.3
-140CAS/140CASLF	4.0 mm	-0.3
-122CAS/122CASLF	2.2 mm	1.0
-120CAS/120CASLF	2.0 mm	1.0
-100CAS/100CASLF	NONE	5.5

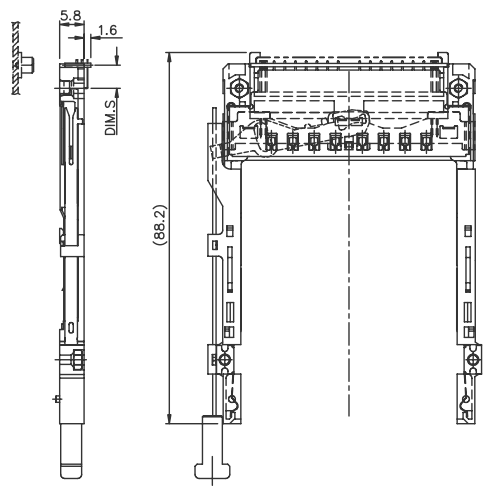

P/N : 73704-100CAS/100CASLF
(ABOVE P.C.B/LAYOUT SEE TA-1050)

mat'l code		tolerance unless otherwise specified		CUSTOMER COPY		 www.fciconnect.com	
rev. G	ecn no.	dr	date	linear	± 0.30	projection	title
				angles	± 2°		CARDBUS EJ HEADER SMT, TYPE 1/2/3
				dr	WENDY CHEN 05/04/99	unit	product family
				enrg	JOSEPH HSIA 05/04/99	mm/inch	PCMCIA
				chr	JOSEPH HSIA 05/04/99	size	dwg no.
				appd	JENN TSAO 05/04/99	scale	73704
sheet index	revision sheet						code
							sheet 8 of

PDM: Rev:H STATUS: Released Printed: Oct 12, 2010

Tous droits strictement réservés. Reproduction ou communication à des tiers sans autorisation écrite du propriétaire. FCI ELECTRONICS. Droits de reproduction BERG ELECTRONICS bv

All rights strictly reserved. Reproduction or issue to third parties in any form without written authority from the proprietor. FCI ELECTRONICS. Copyright BERG ELECTRONICS bv

PRODUCT NO.
SEE TABLE A

TABLE A

① PRODUCT NO.	STAND-OFF(DIM. L)	DIM. S
73704-550CAS/550CASLF	5.0 mm	-0.3
-543CAS/543CASLF	4.3 mm	-0.3
-540CAS/540CASLF	4.0 mm	-0.3
-522CAS/522CASLF	2.2 mm	5.5

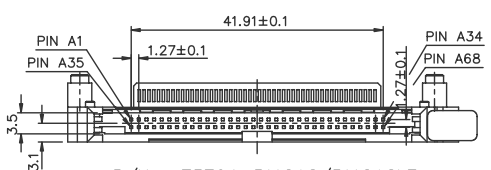
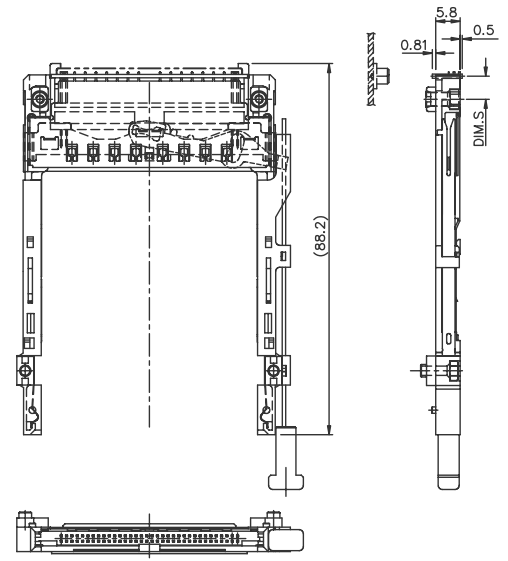
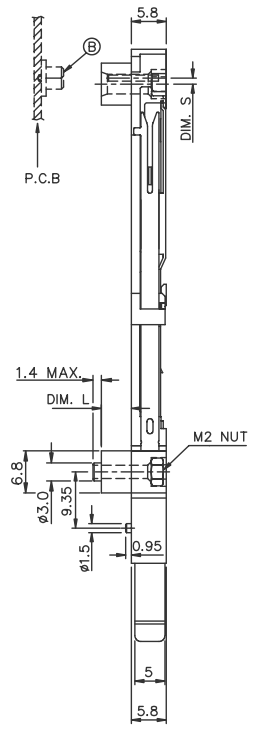
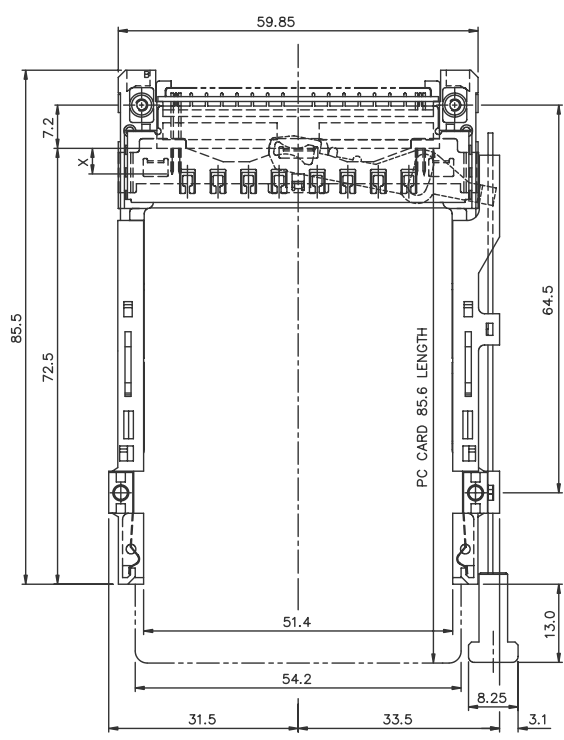

P/N : 73704-5**CAS/5**CASLF
(ABOVE P.C.B/LAYOUT SEE TA-1050)

P/N : 73704-522CAS/522CASLF
(ABOVE P.C.B/LAYOUT SEE TA-1050)

mat'l code	tolerance unless otherwise specified	CUSTOMER COPY	FCI www.fciconnect.com	
rev. H	linear ± 0.30	projection	title CARDBUS EJ HEADER SMT, TYPE 1/2/3	
ecn no. dr date	angles ± 2°	unit mm/inch	product family PCMCIA code	
	dr WENDY CHEN 05/09/97	size A3	dwg no. 73704 sheet 9 of	
	enrg JOSEPH HSIA 05/09/97	scale 1.5:1		
	chr JOSEPH HSIA 05/09/97			
	appd JENN TSAO 05/09/97			
sheet index	revision sheet			

PDM: Rev:H STATUS Released Printed: Oct 12, 2010

Tous droits strictement réservés. Reproduction ou communication à des tiers sans autorisation écrite du propriétaire. FCI ELECTRONICS S.A. Droits de reproduction BERG ELECTRONICS bv

All rights strictly reserved. Reproduction or issue to third parties in any form without written authority from the proprietor. FCI ELECTRONICS S.A. Copyright BERG ELECTRONICS bv

PRODUCT NO.
SEE TABLE A

TABLE A

PRODUCT NO.	STAND-OFF(DIM. L)	DIM. S
73704-650CAS/650CASLF	5.0 mm	-0.3
-643CAS/643CASLF	4.3 mm	-0.3
-640CAS/640CASLF	4.0 mm	-0.3
-622CAS/622CASLF	2.2 mm	5.5

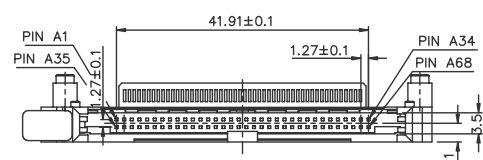
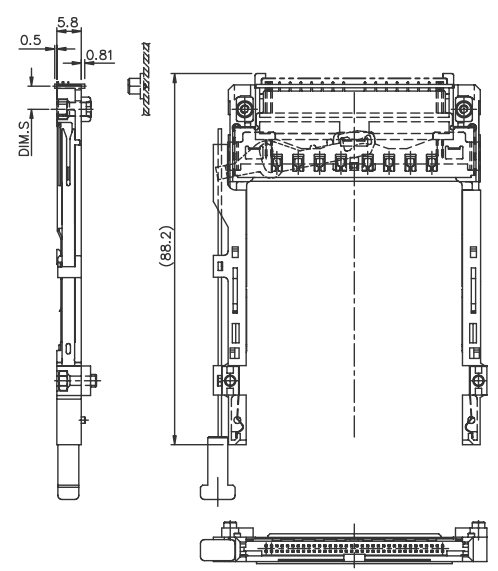
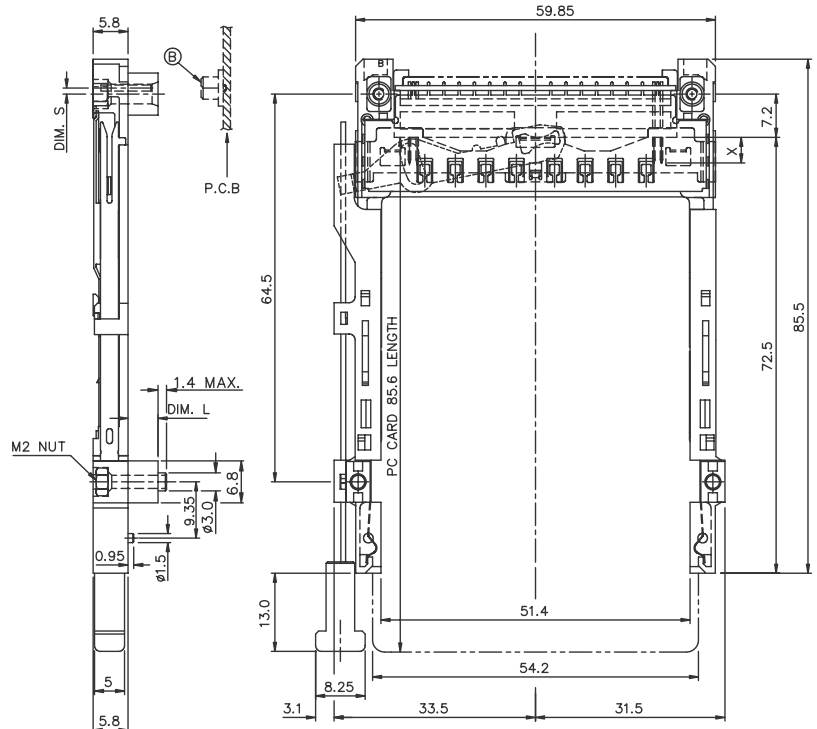

P/N : 73704-6**CAS/6**CASLF
(ABOVE P.C.B/LAYOUT SEE TA-1050)

P/N : 73704-622CAS/622CASLF
(ABOVE P.C.B/LAYOUT SEE TA-1050)

mat'l code		tolerance unless otherwise specified		CUSTOMER COPY		FCI		www.fciconnect.com	
rev.	ecn no.	dr	date	linear	± 0.30	projection	title CARDBUS EJ HEADER SMT, TYPE 1/2/3		
H				angles	± 2°	unit	product family PCMCIA code		
				dr	WENDY CHEN 05/09/97	mm/inch	size dwg no.		sheet
				enrg	JOSEPH HSIA 05/09/97	scale	A3 73704		10 of
				chr	JOSEPH HSIA 05/09/97	1.5:1			
				appd	JENN TSAO 05/09/97				
sheet	revision								
index	sheet								

PDM: Rev:H STATUS Released Printed: Oct 12, 2010

