

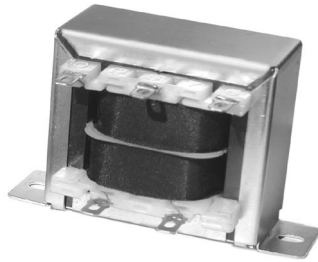









# LAMINATED TRANSFORMERS

## Low Frequency, Open-Style Laminated, Chassis-Tran Series



**AGENCY APPROVALS** 

- UL, 506, File E73539
- UL 1446, File E179499
- CSA 22.2#66, File LR68051-2 
- UL Recognized Class B

-  Channel frame mounting
-  Split bobbin. High isolation (2500V). 2500VRMS Hipot
-  Non-concentric design - eliminates ESS
-  No crossover between primary/secondary winding leads
-  Vacuum impregnated - withstands board washing systems and reduces audible noise
-  Baked resin provides environmentally-resistant finish
-  Center tapped secondary offers dual outputs
-  Terminals suitable for either hard wiring or quick connect

| Part Number  |                 | Secondary RMS Rating |
|--------------|-----------------|----------------------|
| Single 115V  | Dual 115/230V   |                      |
| 241-3-10A1   | (not available) | 10V C.T. @ 0.25A     |
| 241-4-10A11  | DP 241-4-10A11  | 10V C.T. @ 0.6A      |
| 241-5-10A21  | DP 241-5-10A21  | 10V C.T. @ 1.2A      |
| 241-6-10A31  | DP 241-6-10A31  | 10V C.T. @ 3.0A      |
| 241-7-10A41  | DP 241-7-10A41  | 10V C.T. @ 5.0A      |
| 241-8-10A51  | DP 241-8-10A51  | 10V C.T. @ 10A       |
| 241-3-12A2   | (not available) | 12.6V C.T. @ 0.2A    |
| 241-4-12A12  | DP 241-4-12A12  | 12.6V C.T. @ 0.5A    |
| 241-5-12A22  | DP 241-5-12A22  | 12.6V C.T. @ 1.0A    |
| 241-6-12A32  | DP 241-6-12A32  | 12.6V C.T. @ 2.5A    |
| 241-7-12A42  | DP 241-7-12A42  | 12.6V C.T. @ 4.0A    |
| 241-8-12A52  | DP 241-8-12A52  | 12.6V C.T. @ 8.0A    |
| 241-3-16A3   | (not available) | 16V C.T. @ 0.15A     |
| 241-4-16A13  | DP 241-4-16A13  | 16V C.T. @ 0.4A      |
| 241-5-16A23  | DP 241-5-16A23  | 16V C.T. @ 0.8A      |
| 241-6-16A33  | DP 241-6-16A33  | 16V C.T. @ 2.0A      |
| 241-7-16A43  | DP 241-7-16A43  | 16V C.T. @ 3.5A      |
| 241-8-16A53  | DP 241-8-16A53  | 16V C.T. @ 6.25A     |
| 241-3-20A4   | (not available) | 20V C.T. @ 0.12A     |
| 241-4-20A14  | DP 241-4-20A14  | 20V C.T. @ 0.3A      |
| 241-5-20A24  | DP 241-5-20A24  | 20V C.T. @ 0.6A      |
| 241-6-20A34  | DP 241-6-20A34  | 20V C.T. @ 1.5A      |
| 241-7-20A44  | DP 241-7-20A44  | 20V C.T. @ 2.8A      |
| 241-8-20A54  | DP 241-8-20A54  | 20V C.T. @ 5.0A      |
| 241-3-24A5   | (not available) | 24V C.T. @ 0.1A      |
| 241-4-24A15  | DP 241-4-24A15  | 24V C.T. @ 0.25A     |
| 241-5-24A25  | DP 241-5-24A25  | 24V C.T. @ 0.5A      |
| 241-6-24A35  | DP 241-6-24A35  | 24V C.T. @ 1.25A     |
| 241-7-24A45  | DP 241-7-24A45  | 24V C.T. @ 2.4A      |
| 241-8-24A55  | DP 241-8-24A55  | 24V C.T. @ 4.0A      |
| 241-3-28A6   | (not available) | 28V C.T. @ 0.085A    |
| 241-4-28A16  | DP 241-4-28A16  | 28V C.T. @ 0.2A      |
| 241-5-28A26  | DP 241-5-28A26  | 28V C.T. @ 0.42A     |
| 241-6-28A36  | DP 241-6-28A36  | 28V C.T. @ 1.1A      |
| 241-7-28A46  | DP 241-7-28A46  | 28V C.T. @ 2.0A      |
| 241-8-28A56  | DP 241-8-28A56  | 28V C.T. @ 3.6A      |
| 241-3-36A7   | (not available) | 36V C.T. @ 0.065A    |
| 241-4-36A17  | DP 241-4-36A17  | 36V C.T. @ 0.17A     |
| 241-5-36A27  | DP 241-5-36A27  | 36V C.T. @ 0.35A     |
| 241-6-36A37  | DP 241-6-36A37  | 36V C.T. @ 0.85A     |
| 241-7-36A47  | DP 241-7-36A47  | 36V C.T. @ 1.5A      |
| 241-8-36A57  | DP 241-8-36A57  | 36V C.T. @ 2.8A      |
| 241-3-48A8   | (not available) | 48V C.T. @ 0.05A     |
| 241-4-48A18  | DP 241-4-48A18  | 48V C.T. @ 0.125A    |
| 241-5-48A28  | DP 241-5-48A28  | 48V C.T. @ 0.25A     |
| 241-6-48A38  | DP 241-6-48A38  | 48V C.T. @ 0.63A     |
| 241-7-48A48  | DP 241-7-48A48  | 48V C.T. @ 1.2A      |
| 241-8-48A58  | DP 241-8-48A58  | 48V C.T. @ 2.0A      |
| 241-3-56A9   | (not available) | 56V C.T. @ 0.045A    |
| 241-4-56A19  | DP 241-4-56A19  | 56V C.T. @ 0.11A     |
| 241-5-56A29  | DP 241-5-56A29  | 56V C.T. @ 0.22A     |
| 241-6-56A39  | DP 241-6-56A39  | 56V C.T. @ 0.54A     |
| 241-7-56A49  | DP 241-7-56A49  | 56V C.T. @ 1.0A      |
| 241-8-56A59  | DP 241-8-56A59  | 56V C.T. @ 1.8A      |
| 241-3-120A10 | (not available) | 120V C.T. @ 0.02A    |
| 241-4-120A20 | DP 241-4-120A20 | 120V C.T. @ 0.05A    |
| 241-5-120A30 | DP 241-5-120A30 | 120V C.T. @ 0.1A     |
| 241-6-120A40 | DP 241-6-120A40 | 120V C.T. @ 0.25A    |
| 241-7-120A50 | DP 241-7-120A50 | 120V C.T. @ 0.5A     |
| 241-8-120A60 | DP 241-8-120A60 | 120V C.T. @ 0.85A    |

### Mechanicals

### Schematics

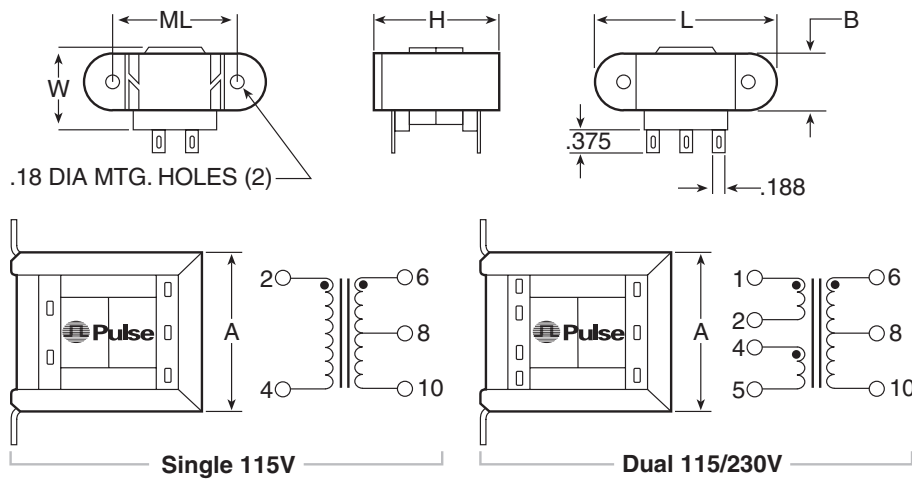

### Dimensions (inches)

| Size | VA  | L    | W    | H    | A    | B    | ML   | Wt. (lb.) |
|------|-----|------|------|------|------|------|------|-----------|
| 3    | 2.4 | 2.06 | 1.06 | 1.19 | 1.62 | 0.56 | 1.75 | 0.25      |
| 4    | 6   | 2.38 | 1.25 | 1.38 | 1.69 | 0.69 | 2.00 | 0.44      |
| 5    | 12  | 2.81 | 1.38 | 1.63 | 1.94 | 0.81 | 2.38 | 0.70      |
| 6    | 30  | 3.25 | 1.69 | 1.94 | 2.31 | 1.06 | 2.81 | 1.10      |
| 7    | 56  | 3.69 | 1.81 | 2.25 | 2.69 | 1.06 | 3.13 | 1.70      |
| 8    | 100 | 4.03 | 2.25 | 2.56 | 3.06 | 1.31 | 3.56 | 2.75      |