

Description

- Miniature surface mount design
- Inductance range from 0.470uH to 1000uH
- Current range from 19.2 to .47 Amps
- Maximum power density
- Ideal for applications requiring low inductance and high current in a miniature package
- Modified standard products are available
- Protective case eliminates core breakage
- Meets UL 94V-0 flammability standard
- Ferrite core material

Applications

- DC-DC converters on board level and industrial products

Environmental Data

- Storage temperature range: -40°C to +125°C
- Operating ambient temperature range: -40°C to +85°C (range is application specific)
- Solder reflow temperature: +260°C max. for 10 seconds max.

Packaging

- Supplied in tape and reel packaging, 900 (UP1B), 550 (UP2B), 450 (UP3B), and 275 (UP4B) per reel

| Part Number | Inductance μH (rated) | OCL ⁽¹⁾ $\mu\text{H} \pm 20\%$ | I _{RMS} ⁽²⁾ Amperes | I _{SAT} ⁽³⁾ Amperes | DCR ⁽⁴⁾ Ohms max. |
|-------------|----------------------------------|---|---|---|------------------------------|
| UP1B-R47-R | 0.47 | 0.569 | 6.0 | 7.7 | 0.0097 |
| UP1B-1R0-R | 1.0 | 1.20 | 4.4 | 5.3 | 0.0177 |
| UP1B-1R5-R | 1.5 | 1.61 | 4.2 | 4.5 | 0.0200 |
| UP1B-2R2-R | 2.2 | 2.62 | 3.1 | 3.5 | 0.0363 |
| UP1B-3R3-R | 3.3 | 3.79 | 2.9 | 3.0 | 0.0428 |
| UP1B-4R7-R | 4.7 | 5.15 | 2.2 | 2.6 | 0.0544 |
| UP1B-6R8-R | 6.8 | 6.87 | 1.7 | 2.2 | 0.0897 |
| UP1B-100-R | 10.0 | 11.00 | 1.5 | 1.9 | 0.1107 |
| UP1B-150-R | 15.0 | 16.00 | 1.2 | 1.5 | 0.1747 |
| UP1B-220-R | 22.0 | 23.50 | 1.0 | 1.2 | 0.2541 |
| UP1B-330-R | 33.0 | 36.00 | 0.82 | 0.99 | 0.3670 |
| UP1B-470-R | 47.0 | 48.50 | 0.72 | 0.87 | 0.4740 |
| UP1B-680-R | 68.0 | 73.52 | 0.58 | 0.67 | 0.7320 |
| UP1B-101-R | 100.0 | 112.67 | 0.47 | 0.53 | 1.11 |
| UP1B-151-R | 150.0 | 152.40 | 0.40 | 0.46 | 1.61 |
| UP1B-221-R | 220.0 | 223.10 | 0.36 | 0.38 | 1.96 |
| UP1B-331-R | 330.0 | 331.90 | 0.28 | 0.31 | 3.10 |
| UP2B-R47-R | 0.47 | 0.595 | 10.6 | 11.4 | 0.0049 |
| UP2B-1R0-R | 1.0 | 1.00 | 9.3 | 9.9 | 0.0065 |
| UP2B-1R5-R | 1.5 | 1.46 | 8.3 | 7.9 | 0.0081 |
| UP2B-2R2-R | 2.2 | 2.56 | 7.2 | 6.1 | 0.0107 |
| UP2B-3R3-R | 3.3 | 3.23 | 6.5 | 5.1 | 0.0128 |
| UP2B-4R7-R | 4.7 | 4.77 | 5.5 | 4.2 | 0.0165 |
| UP2B-6R8-R | 6.8 | 6.63 | 5.0 | 3.6 | 0.0202 |
| UP2B-100-R | 10.0 | 9.73 | 4.3 | 3.3 | 0.0267 |
| UP2B-150-R | 15.0 | 15.43 | 3.5 | 2.4 | 0.0410 |
| UP2B-220-R | 22.0 | 22.50 | 2.8 | 2.0 | 0.0617 |
| UP2B-330-R | 33.0 | 33.13 | 2.1 | 1.7 | 0.0917 |
| UP2B-470-R | 47.0 | 48.65 | 1.7 | 1.4 | 0.1388 |
| UP2B-680-R | 68.0 | 68.17 | 1.5 | 1.2 | 0.1787 |
| UP2B-820-R | 82.0 | 84.1 | 1.34 | 1.03 | 0.2235 |
| UP2B-101-R | 100.0 | 102.60 | 1.2 | 0.95 | 0.2707 |
| UP2B-151-R | 150.0 | 150 | 1.0 | 0.77 | 0.4100 |

Notes: (1) Open Circuit Inductance Test Parameters: 100KHz, .250Vrms, 0.0A dc.

(2) RMS current for an approximate ΔT of 40°C. at an ambient temperature of 85°C.

(3) Peak current for approximately 30% rolloff UP1B, 3B, 4B. 10% rolloff UP2B @ 20°C

(4) DCR limits 20°C.

| Part Number | Inductance μH (rated) | OCL ⁽¹⁾ $\mu\text{H}\pm 20\%$ | I _{RMS} ⁽²⁾ Amperes | I _{SAT} ⁽³⁾ Amperes | DCR ⁽⁴⁾ Ohms max. |
|-------------|----------------------------------|--|---|---|------------------------------|
| UP2B-221-R | 220.0 | 223 | 0.773 | 0.637 | 0.6717 |
| UP2B-331-R | 330.0 | 338 | 0.676 | 0.510 | 0.8783 |
| UP2B-471-R | 470.0 | 471 | 0.553 | 0.427 | 1.31 |
| UP2B-681-R | 680.0 | 700 | 0.452 | 0.355 | 1.97 |
| UP2B-821-R | 820.0 | 823 | 0.423 | 0.334 | 2.24 |
| UP2B-102-R | 1000.0 | 1005 | 0.369 | 0.300 | 2.96 |
| UP3B-R47-R | 0.47 | 0.452 | 16.0 | 25.1 | 0.0021 |
| UP3B-1R0-R | 1.0 | 1.34 | 12.5 | 15.3 | 0.0034 |
| UP3B-1R5-R | 1.5 | 2.08 | 10.0 | 12.0 | 0.0053 |
| UP3B-2R2-R | 2.2 | 3.01 | 9.2 | 10.2 | 0.0074 |
| UP3B-3R3-R | 3.3 | 3.96 | 8.0 | 9.3 | 0.0083 |
| UP3B-4R7-R | 4.7 | 5.00 | 6.5 | 7.7 | 0.0114 |
| UP3B-6R8-R | 6.8 | 7.70 | 5.8 | 6.2 | 0.0183 |
| UP3B-100-R | 10.0 | 11.00 | 4.3 | 5.2 | 0.0260 |
| UP3B-150-R | 15.0 | 16.38 | 3.9 | 4.3 | 0.0317 |
| UP3B-220-R | 22.0 | 23.93 | 3.1 | 3.7 | 0.0490 |
| UP3B-330-R | 33.0 | 33.85 | 2.4 | 3.0 | 0.0688 |
| UP3B-470-R | 47.0 | 51.00 | 1.9 | 2.4 | 0.1082 |
| UP3B-680-R | 68.0 | 69.50 | 1.6 | 2.0 | 0.1558 |
| UP3B-101-R | 100.0 | 101.40 | 1.4 | 1.8 | 0.2053 |
| UP3B-151-R | 150.0 | 152.9 | 1.2 | 1.4 | 0.2960 |
| UP3B-331-R | 330.0 | 332.80 | 0.75 | 0.98 | 0.7330 |
| UP4B-R47-R | 0.47 | 0.473 | 19.2 | 51.7 | 0.0019 |
| UP4B-1R0-R | 1.0 | 0.916 | 17.3 | 37.3 | 0.0023 |
| UP4B-1R5-R | 1.5 | 1.52 | 13.4 | 28.9 | 0.0039 |
| UP4B-2R2-R | 2.2 | 2.27 | 12.0 | 23.7 | 0.0048 |
| UP4B-3R3-R | 3.3 | 3.14 | 11.0 | 20.2 | 0.0057 |
| UP4B-4R7-R | 4.7 | 5.34 | 8.6 | 15.6 | 0.0093 |
| UP4B-6R8-R | 6.8 | 6.66 | 8.3 | 14.1 | 0.0100 |
| UP4B-100-R | 10.0 | 9.77 | 6.8 | 11.5 | 0.0150 |
| UP4B-150-R | 15.0 | 15.61 | 5.5 | 9.1 | 0.0230 |
| UP4B-220-R | 22.0 | 22.61 | 4.5 | 7.6 | 0.0340 |
| UP4B-330-R | 33.0 | 34.30 | 3.7 | 6.1 | 0.0520 |
| UP4B-470-R | 47.0 | 48.10 | 3.1 | 5.2 | 0.0740 |
| UP4B-680-R | 68.0 | 69.14 | 2.4 | 4.3 | 0.1200 |
| UP4B-101-R | 100.0 | 99.42 | 2.0 | 3.6 | 0.1700 |
| UP4B-151-R | 150.0 | 146.90 | 1.7 | 3.0 | 0.2392 |
| UP4B-221-R | 220.0 | 221.40 | 1.4 | 2.4 | 0.3571 |
| UP4B-331-R | 330.0 | 330.00 | 1.1 | 2.0 | 0.5800 |
| UP4B-471-R | 470.0 | 470.10 | 0.91 | 1.7 | 0.8330 |

Notes: (1) Open Circuit Inductance Test Parameters: 100KHz, .250Vrms, 0.0A dc.
(2) RMS current for an approximate ΔT of 40°C. at an ambient temperature of 85°C.

(3) Peak current for approximately 30% rolloff UP1B, 3B, 4B. 10% rolloff UP2B @ 20°C
(4) DCR limits 20°C.

Mechanical Diagrams

UP1B Series

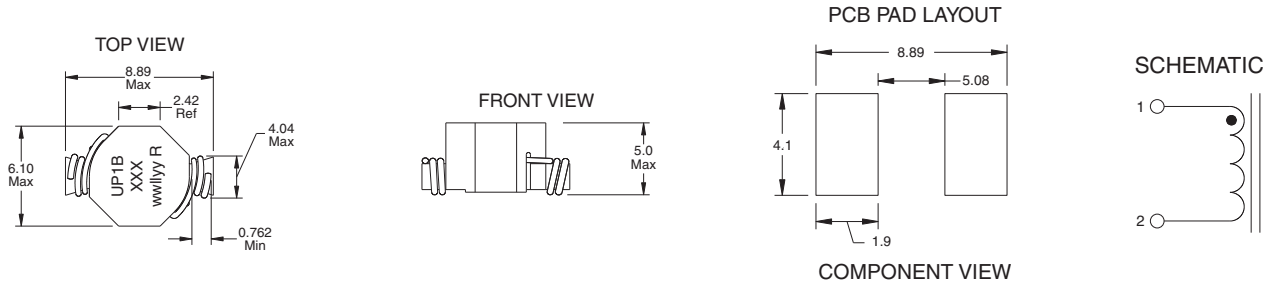

UP2B Series

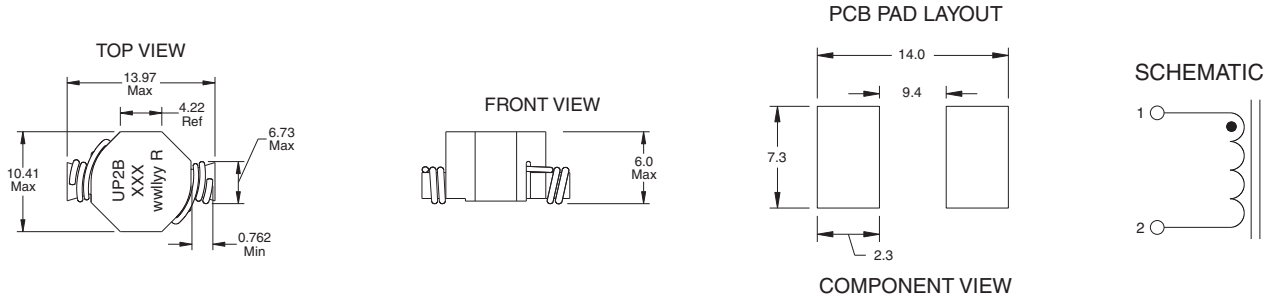

UP3B Series

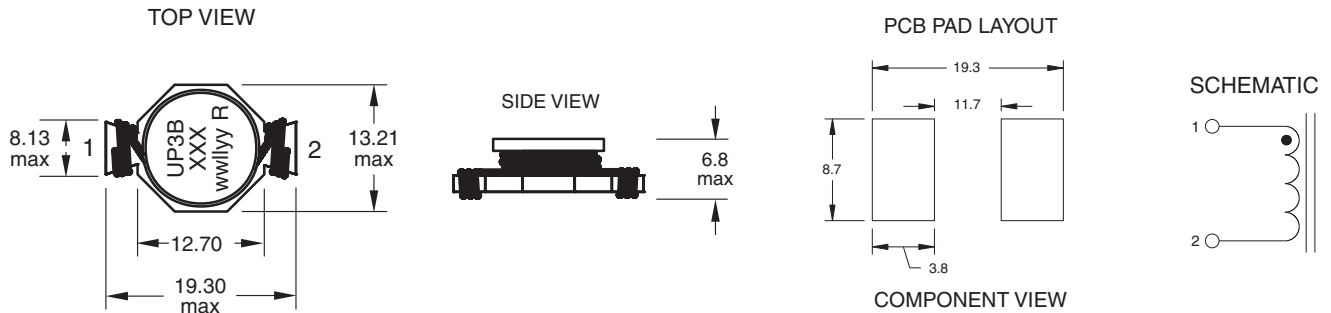

UP4B Series

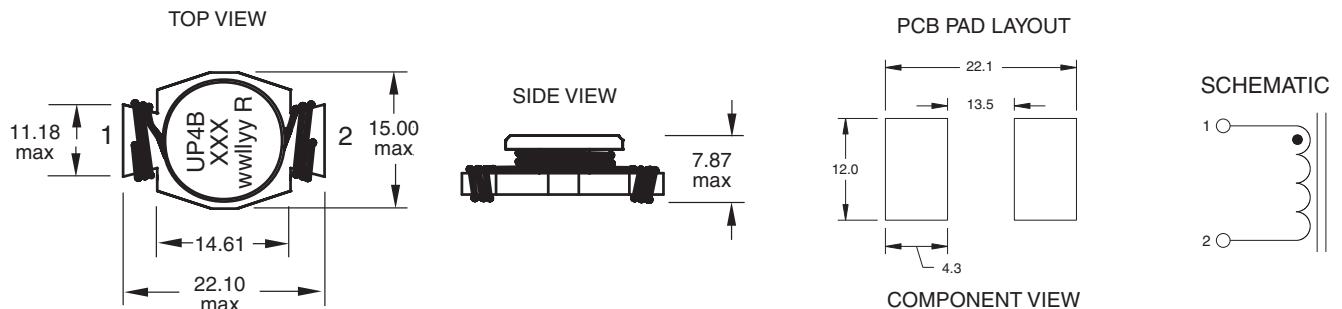

Dimensions in Millimeters.

wwllyy = (date code) R = revision level
 xxx = Inductance value per family chart

Packaging Information

UP1B Series

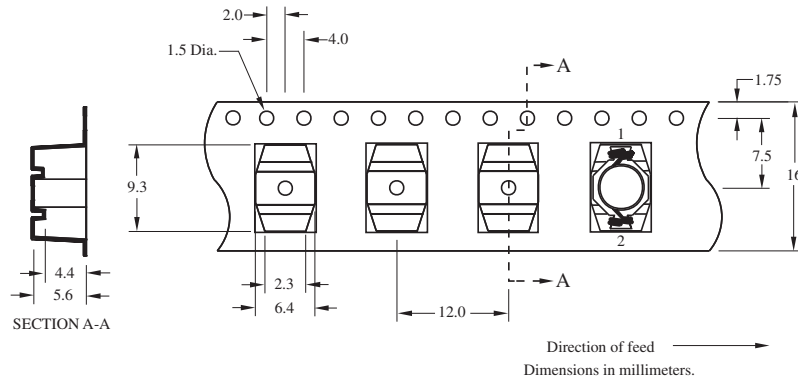

Parts packaged on 13" Diameter reel,
900 parts per reel.

UP2B Series

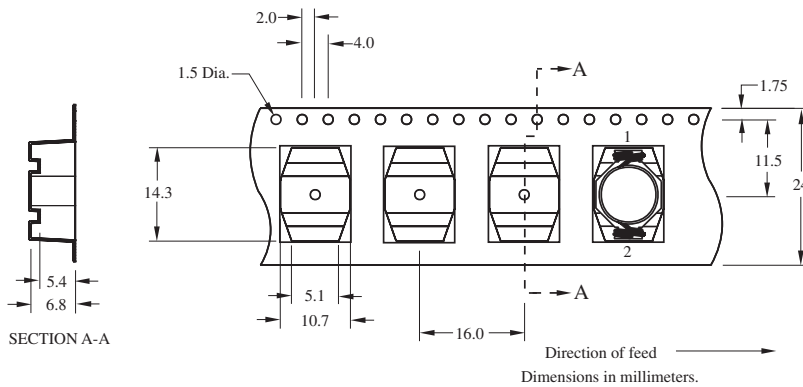

Parts packaged on 13" Diameter reel,
550 parts per reel.

UP3B Series

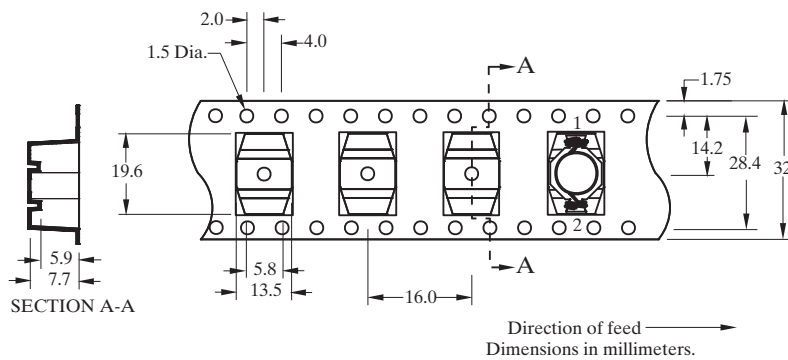

Parts packaged on 13" Diameter reel,
450 parts per reel.

UP4B Series

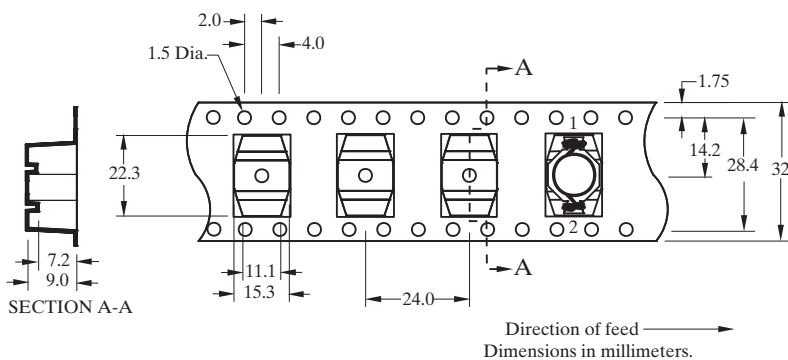

Parts packaged on 13" Diameter reel,
275 parts per reel.

Inductance Characteristics

UP1B-1R0

Typical Inductance & Energy vs Saturation Current

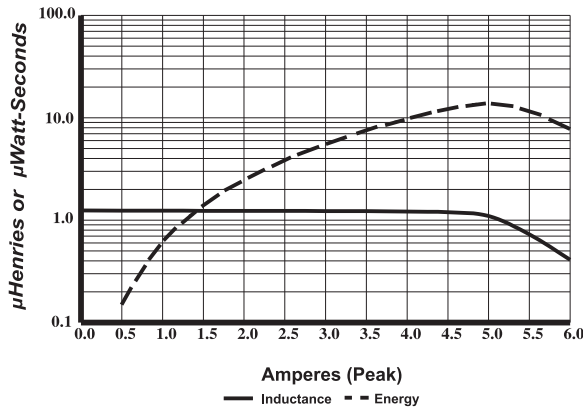

UP1B-100

Typical Inductance & Energy vs Saturation Current

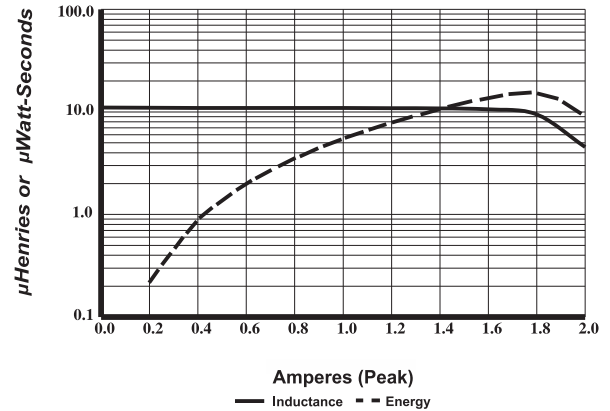

UP1B-470

Typical Inductance & Energy vs Saturation Current

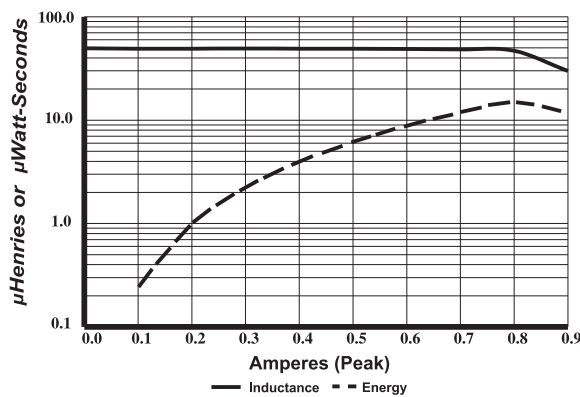

UP2B-1R0

Typical Inductance & Energy vs Saturation Current

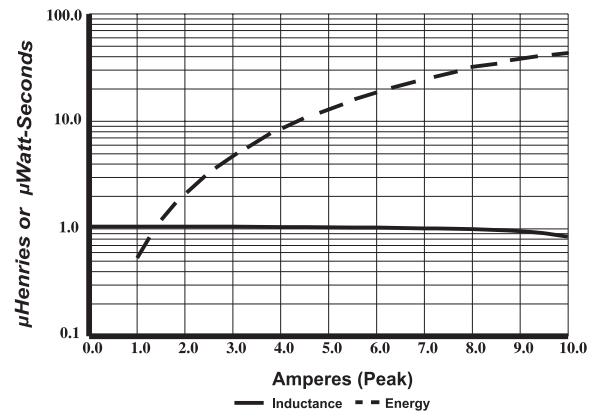

UP2B-100

Typical Inductance & Energy vs Saturation Current

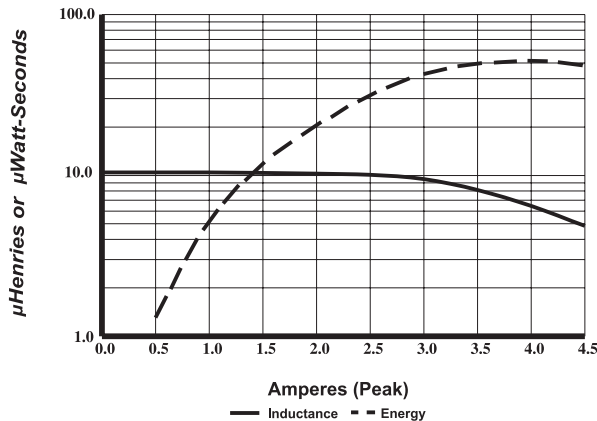

UP2B-470

Typical Inductance & Energy vs Saturation Current

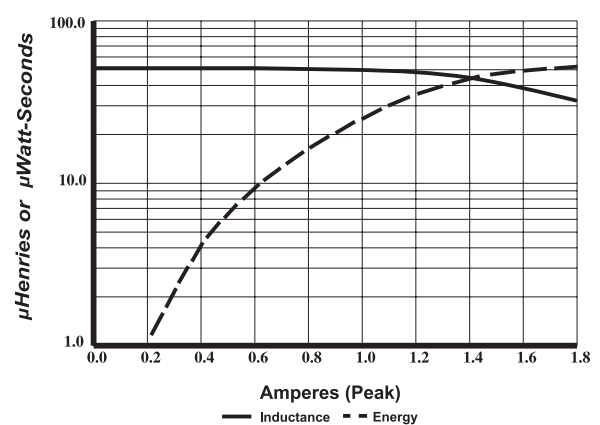

Inductance Characteristics

UP3B-1R0

Typical Inductance & Energy vs Saturation Current

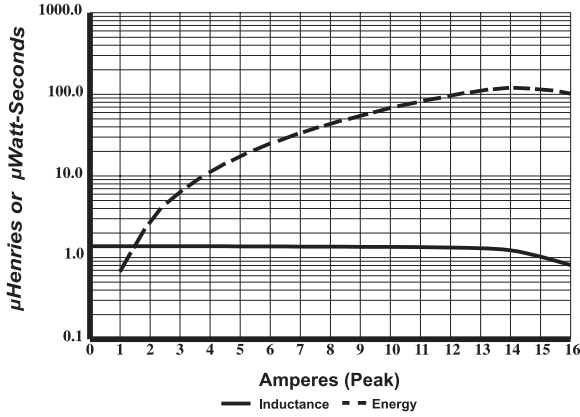

UP3B-100

Typical Inductance & Energy vs Saturation Current

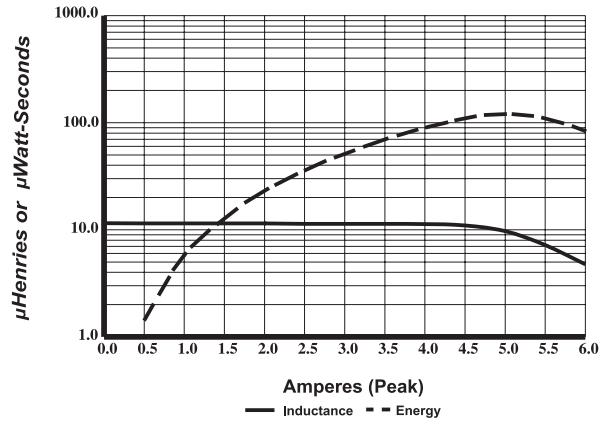

UP3B-470

Typical Inductance & Energy vs Saturation Current

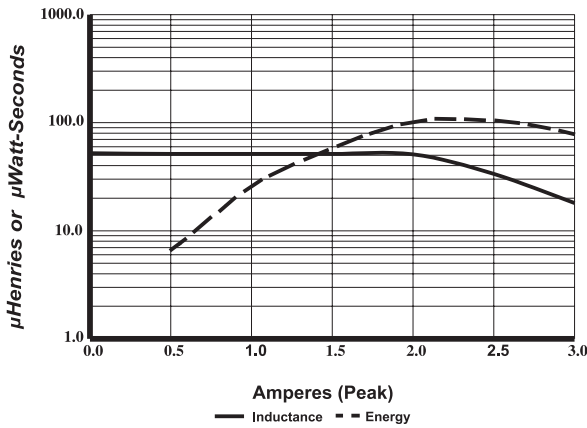

UP4B-1R0

Typical Inductance & Energy vs Saturation Current

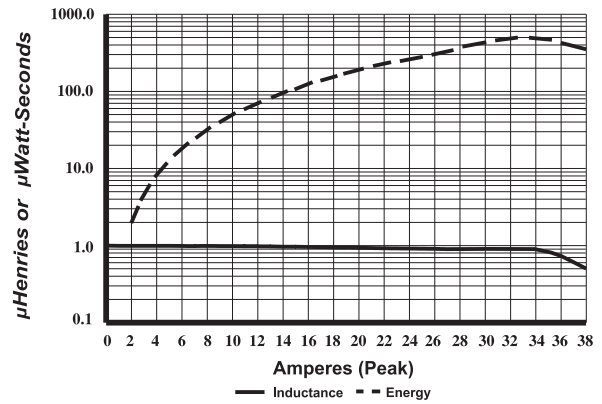

UP4B-100

Typical Inductance & Energy vs Saturation Current

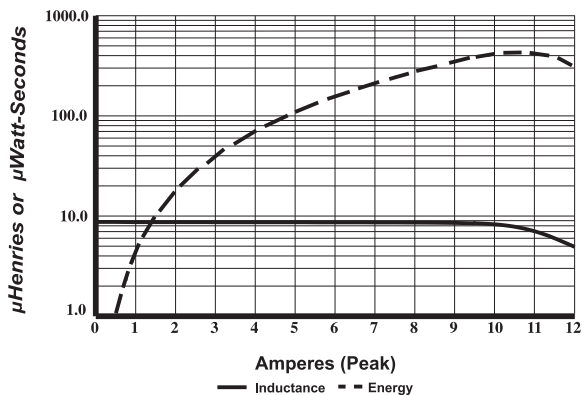

UP4B-470

Typical Inductance & Energy vs Saturation Current

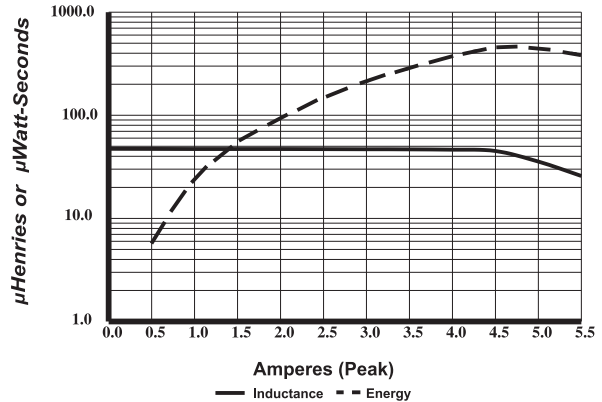

Visit us on the Web at www.cooperbussmann.com

1225 Broken Sound Pkwy. Suite F Boca Raton, FL 33487
Tel: +1-561-998-4100 Toll Free: +1-888-414-2645 Fax: +1-561-241-6640

This bulletin is intended to present product design solutions and technical information that will help the end user with design applications. Cooper Electronic Technologies reserves the right, without notice, to change design or construction of any products and to discontinue or limit distribution of any products. Cooper Electronic Technologies also reserves the right to change or update, without notice, any technical information contained in this bulletin. Once a product has been selected, it should be tested by the user in all possible applications.

Life Support Policy: Cooper Electronic Technologies does not authorize the use of any of its products for use in life support devices or systems without the express written approval of an officer of the Company. Life support systems are devices which support or sustain life, and whose failure to perform, when properly used in accordance with instructions for use provided in the labeling, can be reasonably expected to result in significant injury to the user.