



Features

- Radial Leaded Devices
- High ability to withstand lightning surges
- Ideal lightning surge coordination device
- Binned and sorted narrow resistance ranges available
- Lead free option available
- Agency recognition:   

Applications

- Customer Premise Equipment (CPE)
- Central Office / Telecom Centers (CO)
- Access equipment

MF-R/250 Series - Telecom PTC Resettable Fuses

Electrical Characteristics

Model	Max. Operating Voltage (Vdc)	Max. Interrupt Ratings		Hold Current Amps at 23 °C	Initial Resistance		One Hour Post-Trip Resistance Ohms at 23 °C
		Volts (Vrms)	Amps (A)		Ohms at 23 °C	Ohms at 23 °C	
		Max.	Max.	I _H	Min.	Max.	Max.
MF-R008/250U	60	250	3.0	0.08	14.0	20.0	33.0
MF-R008/250	60	250	3.0	0.08	15.0	22.0	33.0
MF-R011/250U	60	250	3.0	0.11	5.0	9.0	16.0
MF-R012/250	60	250	3.0	0.12	4.0	8.0	16.0
MF-R012/250-A	60	250	3.0	0.12	7.0	9.0	16.0
MF-R012/250-C	60	250	3.0	0.12	5.5	7.5	14.0
MF-R012/250-F	60	250	3.0	0.12	6.0	10.5	16.0
MF-R012/250-1	60	250	3.0	0.12	6.0	9.0	16.0
MF-R012/250-2	60	250	3.0	0.12	8.0	10.5	16.0
MF-R012/250U	60	250	3.0	0.12	6.0	10.0	16.0
MF-R014/250	60	250	3.0	0.145	3.0	6.0	12.0
MF-R014/250-A	60	250	3.0	0.145	3.0	5.5	12.0
MF-R014/250-B	60	250	3.0	0.145	4.5	6.0	14.0
MF-R014/250U	60	250	3.0	0.145	3.5	6.5	12.0
MF-R018/250U	60	250	10.0	0.18	0.8	2.0	4.0

“U” suffix indicates product without insulation coating.

Environmental Characteristics

Operating/Storage Temperature	-40 °C to +85 °C
Maximum Device Surface Temperature	
in Tripped State	125 °C
Passive Aging	+85 °C, 1000 hours±15 % typical resistance change
	+60°C, 1000 hours ±15 % typical resistance change
Humidity Aging	+85 °C, 85 % R.H. 500 hours±15 % typical resistance change
Thermal Shock	MIL-STD-202F, Method 107G,±10 % typical resistance change
	+125 °C to -55 °C, 10 times ±15 % typical resistance change
Solvent Resistance	MIL-STD-202, Method 215BNo change
Lead Solderability	ANSI/J-STD-002>95 % coverage
Flammability	IEC 695-2-2No Flame for 60 secs.
Vibration	MIL-STD-883C, Method 2007.1, Condition A.....±5 % typical resistance change

Test Procedures And Requirements For Model MF-R/250 Series

Test	Test Conditions	Accept/Reject Criteria
Visual/Mech.	Verify dimensions and materials.....	Per MF physical description
Resistance	In still air @ 23 °C	R _{min} ≤ R ≤ R _{1max}
Time to Trip5 times I _{hold} , V _{max} , 23 °C.....	T ≤ typical time to trip (seconds)
Hold Current30 min. at I _{hold}	No trip
Trip Cycle LifeV _{max} , I _{max} , 100 cycles	No arcing or burning
Trip EnduranceV _{max} , 48 hours	No arcing or burning
UL File NumberE 174545S	
CSA File NumberCA 110338	
TÜV File NumberR02057213	

Specifications are subject to change without notice.
Customers should verify actual device performance in their specific applications.

Additional Features

- Assists equipment with meeting ITU-T K.20/K.21/K.45
- Assists equipment with meeting Telcordia GR-1089-C Intrabuilding

MF-R/250 Series - Telecom PTC Resettable Fuses

BOURNS®

Thermal Derating Chart - I_{hold} (Amps)

Model	Ambient Operating Temperature								
	-40 °C	-20 °C	0 °C	23 °C	40 °C	50 °C	60 °C	70 °C	85 °C
MF-R008/250	0.124	0.110	0.095	0.080	0.066	0.059	0.051	0.044	0.033
MF-R011/250U	0.171	0.151	0.131	0.110	0.091	0.081	0.071	0.061	0.046
MF-R012/250	0.186	0.165	0.143	0.120	0.099	0.088	0.077	0.066	0.050
MF-R014/250	0.255	0.199	0.172	0.145	0.119	0.106	0.093	0.080	0.060
MF-R018/250U	0.269	0.240	0.211	0.180	0.153	0.138	0.123	0.109	0.087

I_{trip} is approximately two times I_{hold} .

Product Dimensions

Model	A Max.	B Max.	C Max.	D Min.	E Max.	Physical Characteristics	
						Lead Dia.	Material
MF-R008/250	$\frac{7.5}{(0.295)}$	$\frac{11.5}{(0.453)}$	$\frac{5.1 \pm 0.7}{(0.201 \pm 0.028)}$	$\frac{5.0}{(0.197)}$	$\frac{4.8}{(0.189)}$	$\frac{0.65}{(0.026)}$	Sn/Cu
MF-R008/250U	$\frac{6.2}{(0.244)}$	$\frac{11.5}{(0.453)}$	$\frac{5.1 \pm 0.7}{(0.201 \pm 0.028)}$	$\frac{5.0}{(0.197)}$	$\frac{3.8}{(0.150)}$	$\frac{0.65}{(0.026)}$	Sn/Cu
MF-R011/250U	$\frac{6.2}{(0.244)}$	$\frac{11.5}{(0.453)}$	$\frac{5.1 \pm 0.7}{(0.201 \pm 0.028)}$	$\frac{5.0}{(0.197)}$	$\frac{3.8}{(0.150)}$	$\frac{0.65}{(0.026)}$	Sn/Cu
MF-R012/250	$\frac{7.5}{(0.295)}$	$\frac{11.5}{(0.453)}$	$\frac{5.1 \pm 0.7}{(0.201 \pm 0.028)}$	$\frac{5.0}{(0.197)}$	$\frac{4.8}{(0.189)}$	$\frac{0.65}{(0.026)}$	Sn/Cu
MF-R012/250U	$\frac{6.2}{(0.244)}$	$\frac{11.5}{(0.453)}$	$\frac{5.1 \pm 0.7}{(0.201 \pm 0.028)}$	$\frac{5.0}{(0.197)}$	$\frac{3.8}{(0.150)}$	$\frac{0.65}{(0.026)}$	Sn/Cu
MF-R014/250	$\frac{7.5}{(0.295)}$	$\frac{11.5}{(0.453)}$	$\frac{5.1 \pm 0.7}{(0.201 \pm 0.028)}$	$\frac{5.0}{(0.197)}$	$\frac{4.8}{(0.189)}$	$\frac{0.65}{(0.026)}$	Sn/Cu
MF-R014/250U	$\frac{6.2}{(0.244)}$	$\frac{11.5}{(0.453)}$	$\frac{5.1 \pm 0.7}{(0.201 \pm 0.028)}$	$\frac{5.0}{(0.197)}$	$\frac{3.8}{(0.150)}$	$\frac{0.65}{(0.026)}$	Sn/Cu
MF-R018/250U	$\frac{10.4}{(0.409)}$	$\frac{12.6}{(0.496)}$	$\frac{5.1 \pm 0.7}{(0.201 \pm 0.028)}$	$\frac{5.0}{(0.197)}$	$\frac{3.8}{(0.150)}$	$\frac{0.65}{(0.026)}$	Sn/Cu

Packaging options:

BULK: 500 pcs. per bag. TAPE & REEL: 1500 pcs. per reel (not available with binned option).

DIMENSIONS = $\frac{MM}{(INCHES)}$

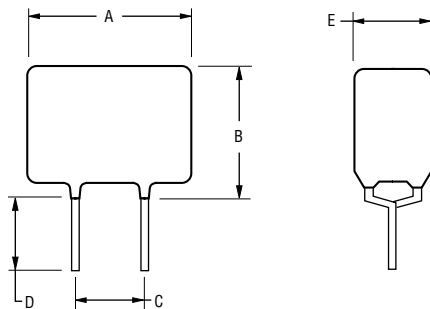

Typical Part Marking

Represents total content. Layout may vary.

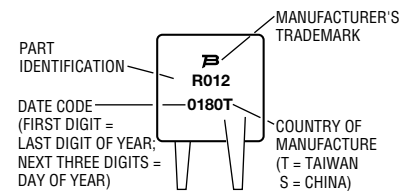

Specifications are subject to change without notice. Customers should verify actual device performance in their specific applications.

MF-R/250 Series - Telecom PTC Resettable Fuses

BOURNS®

How to Order

MF - R 012/250 U - A 05 - 2 - 99

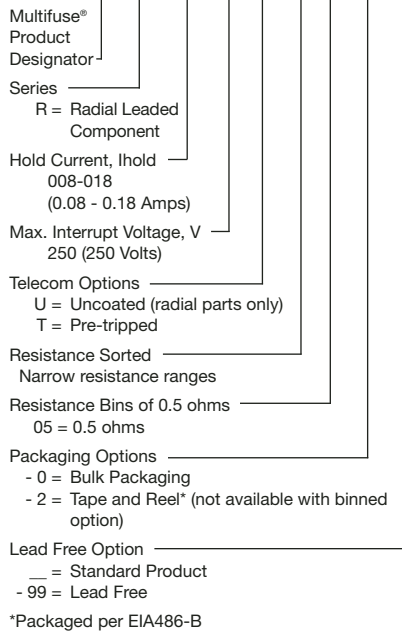

Typical Time to Trip at 23 °C

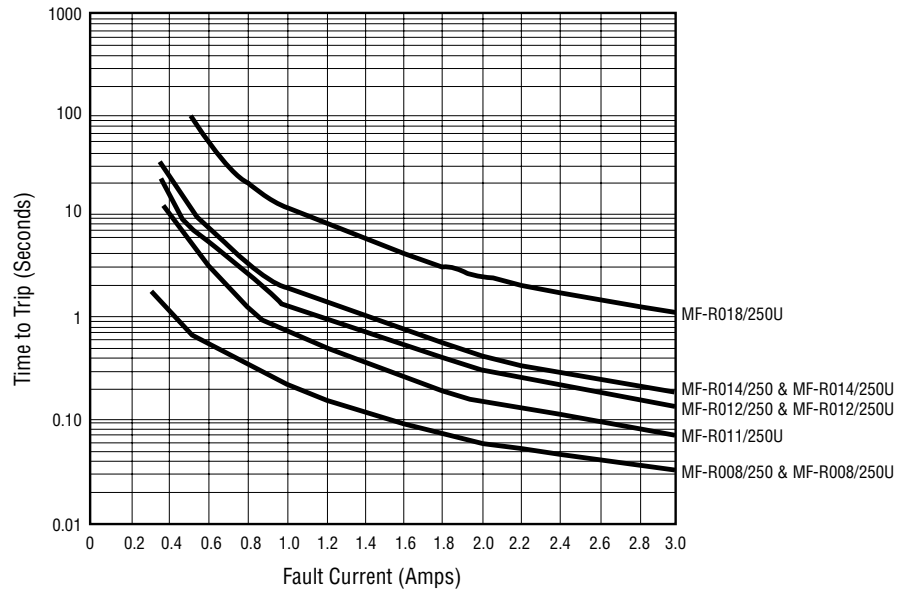

Resistance Options

Model	Rmin.	Rmax.	R1Max.	Bin
MF-R012/250	4.0	8.0	16.0	0.5
MF-R012/250-A05	7.0	9.0	16.0	0.5
MF-R012/250-C05	5.5	7.5	14.0	0.5
MF-R012/250-F05	6.0	10.5	16.0	0.5
MF-R012/250-105	6.0	9.0	16.0	0.5
MF-R012/250-205	8.0	10.5	16.0	0.5
MF-R012/250U	6.0	10.0	16.0	0.5
MF-R014/250	3.0	6.0	12.0	0.5
MF-R014/250-A05	3.0	5.5	12.0	0.5
MF-R014/250-B05	4.5	6.0	12.0	0.5
MF-R014/250U	3.5	6.5	12.0	0.5

**MF-R, MF-RX, MF-R/90, MF-R/250, MF-RX/250 & MF-R/600 Series
Tape and Reel Specifications**

BOURNS®

Devices taped using EIA468-B/IEC286-2 standards. See table below and Figures 1 and 2 for details.

Dimension Description	IEC Mark	EIA Mark	Dimensions	
			Dimensions	Tolerance
Carrier tape width	<i>W</i>	<i>W</i>	$\frac{18}{(.709)}$	$\frac{-0.5/+1.0}{(-0.02/+0.039)}$
Hold down tape width: MF-R/600		<i>W4</i>	$\frac{5}{(.197)}$	min.
Hold down tape width: all others		<i>W4</i>	$\frac{11}{(.433)}$	ref.
Hold down tape	<i>W0</i>		No protrusion	
Top distance between tape edges	<i>W2</i>	<i>W6</i>	$\frac{3}{(.118)}$	max.
Sprocket hole position	<i>W1</i>	<i>W5</i>	$\frac{9}{(.354)}$	$\frac{-0.5/+0.75}{(-0.02/+0.03)}$
Sprocket hole diameter	<i>D0</i>	<i>D0</i>	$\frac{4}{(.157)}$	$\frac{\pm 0.2}{(\pm .0078)}$
Abscissa to plane (straight lead)	<i>H</i>	<i>H</i>	$\frac{18.5}{(.728)}$	$\frac{\pm 3.0}{(\pm .118)}$
Abscissa to plane (kinked lead)	<i>H0</i>	<i>H0</i>	$\frac{16}{(.63)}$	$\frac{\pm 0.5}{(\pm .02)}$
Abscissa to top	<i>H1</i>	<i>H1</i>	$\frac{32.2}{(1.268)}$	max.
Overall width w/lead protrusion		<i>C1</i>	$\frac{43.2}{(1.7)}$	max.
Overall width w/o lead protrusion		<i>C2</i>	$\frac{42.5}{(1.673)}$	max.
Lead protrusion	<i>I1</i>	<i>L1</i>	$\frac{1.0}{(.039)}$	max.
Protrusion of cutout	<i>L</i>	<i>L</i>	$\frac{11}{(.433)}$	max.
Protrusion beyond hold tape	<i>I2</i>	<i>I2</i>	Not specified	
Sprocket hole pitch	<i>P0</i>	<i>P0</i>	$\frac{12.7}{(0.5)}$	$\frac{\pm 0.3}{(\pm .012)}$
Pitch tolerance			20 consecutive	± 1
Device pitch: MF-R005 – MF-R160 & MF-R/90			$\frac{12.7}{(0.5)}$	
Device pitch: MF-R185 – MF-R400 & MF-R/600			$\frac{25.4}{(1.0)}$	
Device pitch: MF-RX110 – MF-RX160			$\frac{12.7}{(0.5)}$	
Device pitch: MF-RX185 – MF-RX375			$\frac{12.7}{(0.5)}$	
Device pitch: MF-R/250 & MF-RX/250			$\frac{12.7}{(0.5)}$	
Tape thickness	<i>t</i>	<i>t</i>	$\frac{0.9}{(.035)}$	max.
Tape thickness with splice		<i>t1</i>	$\frac{2.0}{(.079)}$	max.
Splice sprocket hole alignment			0	$\frac{\pm 0.3}{(\pm .012)}$
Body lateral deviation	Δh	Δh	0	$\frac{\pm 1.0}{(\pm .039)}$
Body tape plane deviation	Δp	Δp	0	$\frac{\pm 1.3}{(\pm .051)}$
Lead seating plane deviation: MF-R/600*	$\Delta P1$	<i>P1</i>	$\frac{3.81}{(0.15)}$	$\frac{\pm 0.7}{(\pm .028)}$
Lead seating plane deviation	$\Delta P1$	<i>P1</i>	0	$\frac{\pm 0.7}{(\pm .028)}$
Lead spacing	<i>F</i>	<i>F</i>	$\frac{5.08}{(0.2)}$	$\frac{\pm 0.8}{(\pm .035)}$
Reel width	<i>w</i>	<i>w</i>	$\frac{56}{(2.205)}$	max.
Reel diameter	<i>d</i>	<i>a</i>	$\frac{370}{(14.57)}$	max.
Space between flanges less device			$\frac{4.75}{(.187)}$	$\frac{\pm 3.25}{(\pm .128)}$

*Differs from EIA specification.

Specifications are subject to change without notice.

Customers should verify actual device performance in their specific applications.

DIMENSIONS = $\frac{\text{MM}}{\text{(INCHES)}}$

**MF-R, MF-RX, MF-R/90, MF-R/250, MF-RX/250 & MF-R/600 Series
Tape and Reel Specifications**

BOURNS®

Dimension Description	IEC Mark	EIA Mark	Dimensions	
			Dimensions	Tolerance
Space between flanges less device			4.75 (.187)	± 3.25 ($\pm .128$)
Arbor hole diameter	<i>f</i>	<i>c</i>	26 (1.024)	± 12.0 ($\pm .472$)
Core diameter: MF-R, MF-RX, MF-R/90 & MF-R/250	<i>h</i>	<i>n</i>	80 (3.15)	max.
Core diameter: MF-RX/250 & MF-R/600	<i>h</i>	<i>n</i>	91 (3.58)	max.
Box: MF-R, MF-RX, MF-R/90 & MF-R/250			56 372 372 (2.2) (14.6) (14.6)	max.
Box: MF-RX/250			67 372 362 (2.64) (14.6) (14.25)	max.
Box: MF-R/600			64 372 362 (2.52) (14.6) (14.25)	max.
Consecutive missing places: MF-R, MF-RX, MF-R/90 & MF-R/250			3	max.
Consecutive missing places: MF-RX/250 & MF-R/600			None	
Empty places per reel: MF-R, MF-RX, MF-R/90 & MF-R/250				Not specified
Empty places per reel: MF-RX/250 & MF-R/600			0.1 %	

Taped Component Dimensions - Figure 1

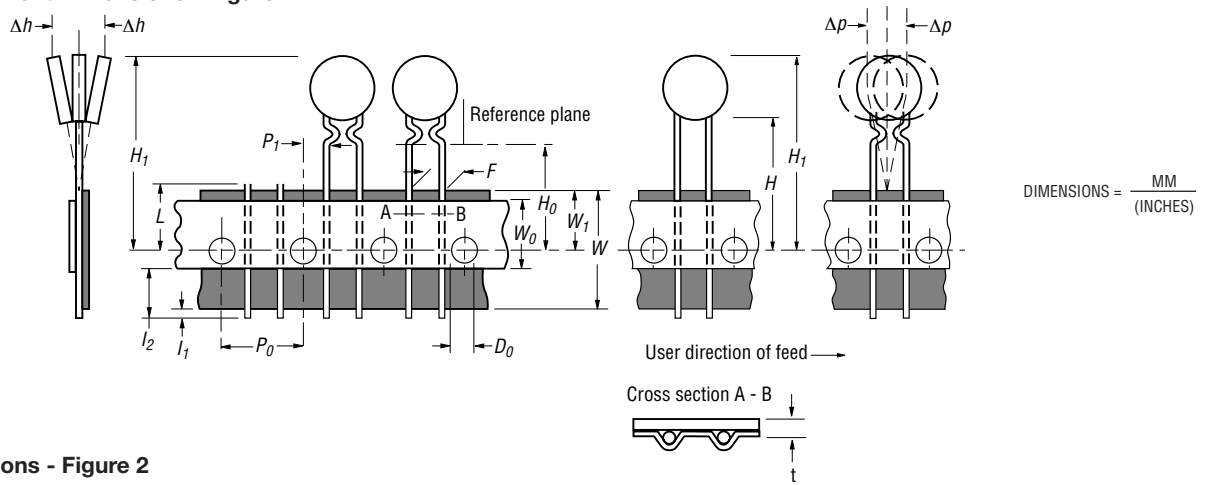

Reel Dimensions - Figure 2

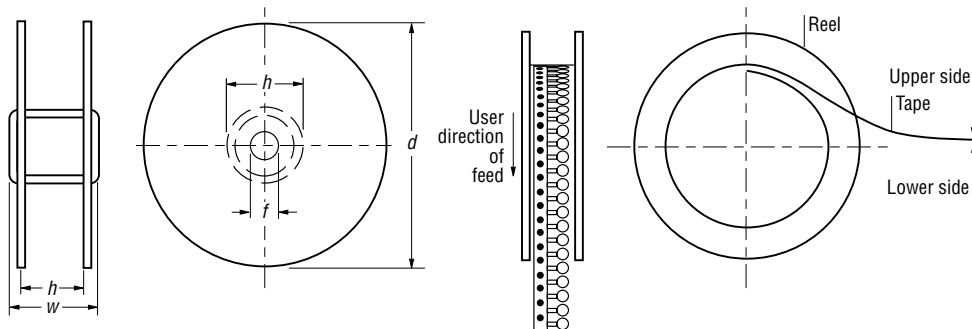

Specifications are subject to change without notice.
Customers should verify actual device performance in their specific applications.