

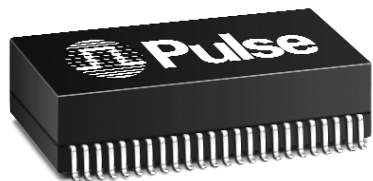





# T1/CEPT/ISDN-PRI TRANSFORMER

## Quad Port SMT Transformer Module with Line Side Protection



-  Four transmit transformers, four receive transformers and line side protection circuit in a surface mount package
-  Extended temperature range
-  Patented "Interlock Base" construction for high reliability
-  IC grade transfer-molded package withstands 235°C IR reflow temperature
-  Minimum Isolation voltage: 1500 Vrms
-  UL recognized

### Electrical Specifications @ 25°C — Operating Temperature -40°C to +85°C

| Part Number | Turns Ratio (Pri:Sec ±2%) |          | OCL Line Side (mH MIN) | Cw/w (pF MAX) | LL (μH MAX) | Package/ Schematic | Primary Pins             |                            |
|-------------|---------------------------|----------|------------------------|---------------|-------------|--------------------|--------------------------|----------------------------|
|             | Transmit                  | Receive  |                        |               |             |                    | Transmit                 | Receive                    |
| TX9032      | 1CT:1                     | 1:1CT    | 1.2                    | 35 & 35       | .80 & .80   | BRT                | 4-6, 10-12, 16-18, 22-24 | 48-46, 42-40, 36-34, 30-28 |
| TX9033      | 1CT:1.14                  | 1.14:1CT | 1.2                    | 35 & 35       | 1.0 & 1.0   | BRT                | 4-6, 10-12, 16-18, 22-24 | 48-46, 42-40, 36-34, 30-28 |

### Mechanical

### Schematic

#### BRT

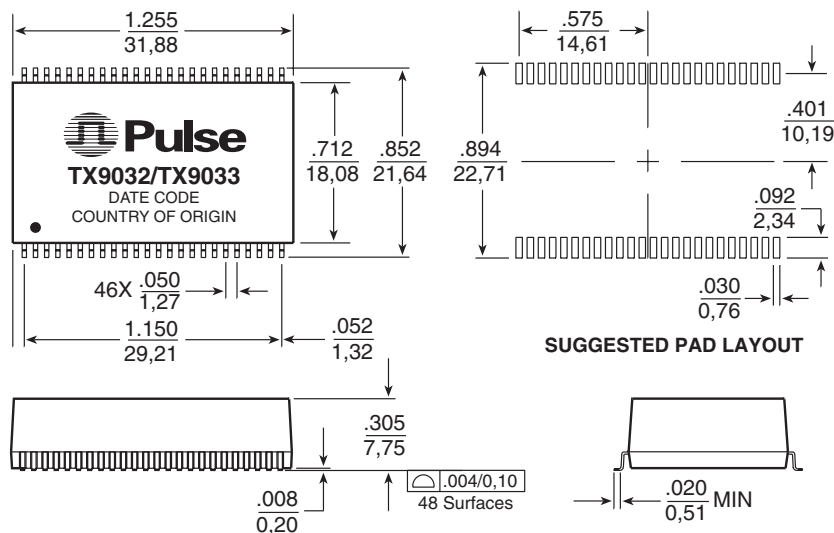

Weight .....9.2 grams  
Tape & Reel .....150/reel  
Tube .....15/tube

Dimensions: Inches  
mm  
Unless otherwise specified, all tolerances are ± .010  
0,25

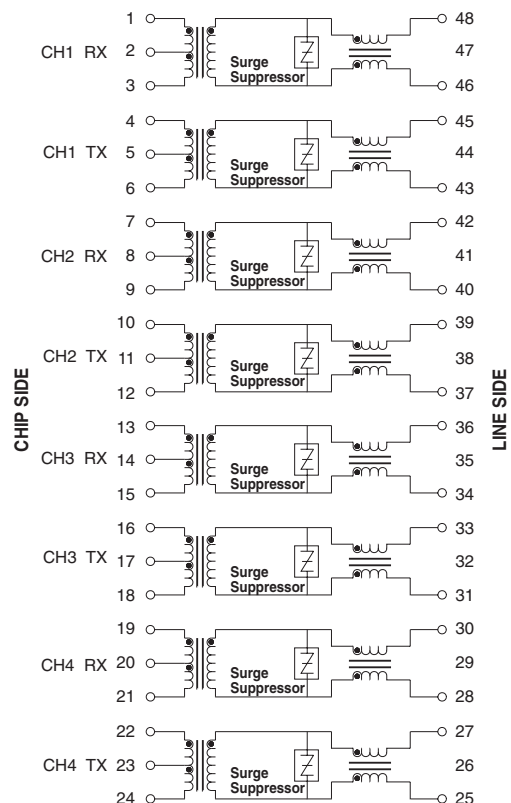

### For More Information:

**Pulse Worldwide Headquarters**  
12220 World Trade Drive  
San Diego, CA 92128  
U.S.A.

[www.pulseeng.com](http://www.pulseeng.com)  
TEL: 858 674 8100  
FAX: 858 674 8262

**Pulse Northern Europe**  
3 Huxley Road  
Surrey Research Park  
Guildford, Surrey GU2 5RE  
United Kingdom

TEL: 44 1483 401700  
FAX: 44 1483 401701

**Pulse Southern Europe**  
Zone Industrielle  
F-39270  
Orgelet  
France

TEL: 33 3 84 35 04 04  
FAX: 33 3 84 25 46 41

**Pulse China Headquarters**  
No. 1  
Industrial District  
Changan, Dongguan  
China

TEL: 86 769 85538070  
FAX: 86 769 85538870

**Pulse North China**  
Room 1503  
XinYin Building  
No. 888 YiShan Road  
Shanghai 200233  
China

TEL: 86 21 54643211/2  
FAX: 86 21 54643210

**Pulse South Asia**  
150 Kampong Ampat  
#07-01/02  
KA Centre  
Singapore 368324

TEL: 65 6287 8998  
FAX: 65 6280 0080

**Pulse North Asia**  
No. 26  
Kao Ching Road  
Yang Mei Chen  
Taoyuan Hsien  
Taiwan, R. O. C.

TEL: 886 3 4641811  
FAX: 886 3 4641911

Performance warranty of products offered on this data sheet is limited to the parameters specified. Data is subject to change without notice. Other brand and product names mentioned herein may be trademarks or registered trademarks of their respective owners.

© Copyright, 2006. Pulse Engineering, Inc. All rights reserved.

[www.pulseeng.com](http://www.pulseeng.com)

T680.A (5/06)