

# T1/CEPT/ISDN-PRI TRANSFORMERS

## Dual Surface Mount, 1500Vrms, Extended and Standard Temperature Range



- Dual SMT package contains both transmit and receive transformers
- Models matched to leading transceiver ICs
- Isolation voltage: 1500Vrms
- UL recognized
- RoHS compliant versions available

### Electrical Specifications @ 25°C

| Part Number   | Turns Ratio <sup>B</sup><br>(Pri:Sec ± 2%) | OCL @ 25°C<br>(mH MIN) | L <sub>L</sub><br>(μH MAX) | C <sub>w/w</sub><br>(pF MAX) | DCR Pri<br>(Ω MAX) | DCR Sec<br>(Ω MAX) | Package/<br>Schematic | Primary<br>Pins |
|---|--|------------------------|----------------------------|------------------------------|--------------------|--------------------|-----------------------|-----------------|
| <b>EXTENDED TEMPERATURE RANGE MODELS<sup>1</sup> – OPERATING TEMPERATURE -40°C TO +85°C</b> |  |                        |                            |                              |                    |                    |                       |                 |
| PE-68841  | 1CT:2CT & 1CT:2CT                          | 1.20 & 1.20            | 0.80 & 0.80                | 50 & 50                      | 1.00 & 1.00        | 1.70 & 1.70        | AN/2                  | 12-10, 4-6      |
| PE-68822  | 1CT:2CT & 1:1.36CT                         | 1.60 & 1.60            | 1.00 & 0.80                | 60 & 55                      | 1.70 & 1.70        | 2.00 & 1.70        | AN/1                  | 12-10, 4-6      |
| PE-68825  | 1:1.15CT & 1CT:2CT                         | 1.60 & 1.60            | 0.80 & 0.80                | 60 & 50                      | 1.00 & 1.00        | 1.20 & 2.00        | AN/4                  | 12-10, 4-6      |
| PE-68826 <sup>E</sup>   | 1:1/1.26 & 1:2CT                           | 1.20 & 1.20            | 0.80 & 0.80                | 50 & 60                      | 1.00 & 1.00        | 1.10 & 1.70        | AN/5                  | 12-10, 4-6      |
| PE-68827  | 1:1CT & 2:1                                | 1.60 & 1.60            | 1.30 & 1.30                | 55 & 40                      | 1.10 & 1.10        | 1.10 & 0.70        | AN/6                  | 1-3, 4-6        |
| PE-68828  | 1CT:1CT & 1CT:1CT                          | 1.20 & 1.20            | 0.80 & 0.80                | 50 & 50                      | 1.00 & 1.00        | 1.00 & 1.00        | AN/2                  | 1-3, 4-6        |
| PE-68874  | 1CT:1.15CT & 1CT:1.15CT                    | 1.20 & 1.20            | 0.80 & 0.80                | 50 & 50                      | 1.20 & 1.20        | 1.40 & 1.40        | AN/2                  | 1-3, 4-6        |
| PE-68877  | 1CT:1CT & 1CT:2CT                          | 1.20 & 1.20            | 0.80 & 0.80                | 50 & 50                      | 1.00 & 1.00        | 1.00 & 1.80        | AN/2                  | 1-3, 4-6        |
| PE-68882  | 1CT:1.15CT & 1CT:1CT                       | 1.60 & 1.60            | 0.80 & 0.80                | 60 & 60                      | 1.20 & 1.20        | 1.40 & 1.20        | AN/2                  | 12-10, 4-6      |
| PE-68884  | 1CT:1.36CT & 1CT:1.36CT                    | 1.20 & 1.20            | 0.80 & 0.80                | 50 & 50                      | 1.20 & 1.20        | 1.40 & 1.40        | AN/2                  | 1-3, 4-6        |
| PE-68887  | 1CT:1.41CT & 1CT:1.41CT                    | 1.20 & 1.20            | 0.80 & 0.80                | 50 & 50                      | 1.40 & 1.40        | 1.20 & 1.20        | AN/2                  | 12-10, 9-7      |
| PE-68881  | 1CT:2.3CT & 1CT:2CT                        | 1.20 & 1.20            | 0.80 & 0.80                | 60 & 50                      | 1.20 & 1.20        | 2.10 & 2.10        | AN/2                  | 10-12, 4-6      |
| TX1277  | 1CT:1CT & 1CT:2CT                          | 1.20 & 1.20            | 0.80 & 0.80                | 50 & 50                      | 1.00 & 1.00        | 1.00 & 1.80        | AN/2                  | 1-3, 4-6        |
| <b>STANDARD TEMPERATURE RANGE MODELS – OPERATING TEMPERATURE 0°C TO +70°C</b>               |  |                        |                            |                              |                    |                    |                       |                 |
| T1131 <sup>1</sup>  | 1CT:1 & 1:1.36CT                           | 0.70 & 0.70            | 0.70 & 0.70                | 20 & 20                      | 0.25 & 0.50        | 0.80 & 0.40        | AN/7                  | 1-3, 9-7        |
| PE-68861  | 1CT:2CT & 1CT:2CT                          | 1.20 & 1.20            | 0.60 & 0.60                | 35 & 35                      | 0.70 & 0.70        | 1.20 & 1.20        | AN/2                  | 12-10, 4-6      |
| PE-68862  | 1CT:2CT & 1:1.36CT                         | 1.20 & 1.20            | 0.60 & 0.80                | 35 & 37                      | 0.70 & 0.70        | 1.20 & 0.90        | AN/1                  | 12-10, 4-6      |
| PE-68863  | 1:2CT & 1:1.14CT                           | 1.20 & 1.20            | 0.55 & 0.80                | 40 & 35                      | 0.70 & 0.70        | 1.20 & 0.90        | AN/5                  | 12-10, 4-6      |
| PE-68864 <sup>A</sup>   | 1CT:2CT & 1:1                              | 1.20 & 1.20            | 0.30-0.55 & 0.80           | 30 & 30                      | 0.70 & 0.70        | 1.20 & 0.70        | AN/3                  | 1-3, 5-6        |
| PE-68865  | 1:1.15CT & 1CT:2CT                         | 1.50 & 1.20            | 0.80 & 0.60                | 35 & 35                      | 0.70 & 0.70        | 0.90 & 1.20        | AN/4                  | 12-10, 4-6      |
| PE-68866 <sup>E</sup>   | 1:1/1.26 & 1:2CT                           | 1.50 & 1.20            | 0.40 & 0.50                | 40 & 40                      | 0.70 & 0.70        | 0.90 & 1.20        | AN/5                  | 12-10, 4-6      |
| PE-68869  | 1CT:2CT & 1:1.08CT                         | 1.20 & 1.20            | 0.60 & 0.60                | 40 & 30                      | 0.70 & 0.70        | 1.10 & 0.90        | AN/1                  | 12-10, 4-6      |
| PE-68836 <sup>E</sup>   | 1:1/1.26 & 1:1/1.26                        | 1.50 & 1.50            | 0.40 & 0.40                | 45 & 45                      | 0.80 & 0.80        | 1.00 & 1.00        | AN/7                  | 12-10, 9-7      |

Note: RoHS-6 compliant parts can be ordered by adding an "NL" suffix to the part number (i.e. PE-68841 becomes PE-68841NL). (See Pages 6 and 7 for Table Notes)

### Mechanical

### Schematics

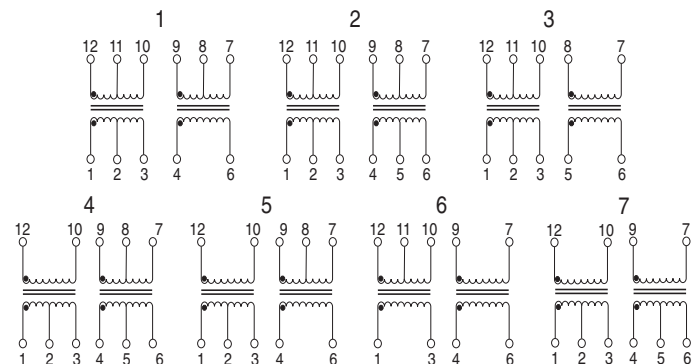
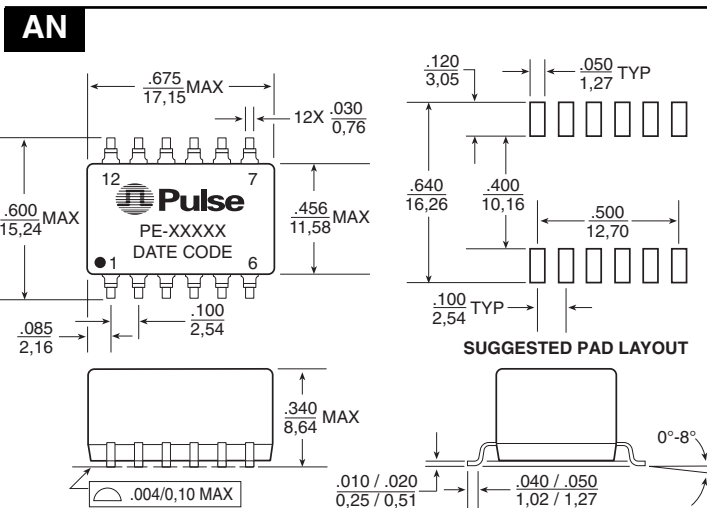

Weight . . . . . 4.0 grams  
Tape & Reel . . . . . .250/reel  
Tube . . . . . .30/tube

Dimensions: Inches  
mm  
Unless otherwise specified,  
all tolerances are ± .010  
0,25

# T1/CEPT/ISDN-PRI TRANSFORMERS

## Dual Surface Mount, 1500Vrms, Small Package



- Dual SMT package contains both transmit and receive transformers
- Models matched to leading transceiver ICs
- UL recognized (some parts pending approval)
- RoHS compliant versions available upon request

### Electrical Specifications @ 25°C

| Part # (STD temp.)    | Part # (EXT temp.) | Turns Ratio <sup>B</sup> (Pri:Sec ±5%) | OCL (mH MIN) | C <sub>w/w</sub> (pF MAX) | L <sub>L</sub> (μH MAX) | DCR Pri (Ω MAX) | Package/Schematic | Primary Pins |
|-----------------------|--------------------|--|--------------|---------------------------|-------------------------|-----------------|-------------------|--------------|
| PE-65861              | T1090              | 1CT:2CT & 1CT:2CT                      | 1.20 & 1.20  | 30 & 30                   | .60 & .60               | 0.70 & 0.70     | BH/1              | 16-14, 6-8   |
| PE-65862              | T1091              | 1CT:2CT & 1:1.36CT                     | 1.20 & 1.20  | 30 & 30                   | .60 & .60               | 0.70 & 0.70     | BH/2              | 16-14, 6-8   |
| PE-65865              | T1076              | 1:1.15CT & 1CT:2CT                     | 1.20 & 1.20  | 30 & 30                   | .60 & .60               | 0.70 & 0.70     | BH/3              | 16-14, 6-8   |
| PE-65866 <sup>E</sup> | T1092 <sup>E</sup> | 1:1/1.26 & 1CT:2CT                     | 1.20 & 1.20  | 30 & 30                   | .60 & .60               | 0.70 & 0.70     | BH/3              | 16-14, 6-8   |
| PE-65870              | T1093              | 1CT:1.15CT & 1CT:1.15CT                | 1.20 & 1.20  | 30 & 30                   | .60 & .60               | 0.70 & 0.70     | BH/1              | 1-3, 6-8     |
| T1022                 | T1077              | 1CT:1CT & 1CT:1.5CT                    | 1.20 & 1.20  | 30 & 30                   | .80 & .80               | 0.70 & 0.70     | BH/1              | 16-14, 6-8   |
| PE-68678              | T1094              | 1CT:1CT & 1CT:2CT                      | 1.20 & 1.20  | 30 & 30                   | .60 & .60               | 0.70 & 0.70     | BH/1              | 16-14, 6-8   |
| PE-68786              | T1095              | 1CT:1.41CT & 1CT:1.41CT                | 1.00 & 1.00  | 30 & 30                   | .60 & .60               | 0.70 & 0.70     | BH/1              | 16-14, 11-9  |
| T1023                 | T1096              | 1CT:1.41CT & 1CT:1.41CT                | 1.00 & 1.00  | 30 & 30                   | .60 & .60               | 0.70 & 0.70     | BH/1              | 1-3, 11-9    |
| —                     | T1144              | 1CT:1CT & 1CT:2.4CT                    | 1.00 & 1.00  | 30 & 30                   | .80 & .80               | 0.85 & 0.85     | BH/1              | 9-11, 1-3    |
| —                     | T1097              | 1CT:1CT & 1CT:1.67CT                   | 1.00 & 1.00  | 25 & 25                   | .80 & .80               | 0.80 & 0.80     | BH/1              | 6-8, 14-16   |
| T1136                 | —                  | 1CT:1CT & 1CT:1.36CT                   | 1.20 & 1.20  | 30 & 30                   | .60 & .60               | 0.70 & 0.70     | BH/1              | 6-8, 1-3     |
| T1121                 | —                  | 1CT:1.5CT & 1CT:1.5CT                  | 1.50 & 1.50  | 40 & 40                   | .80 & .80               | 0.70 & 0.70     | BH/1              | 1-3, 6-8     |
| T1122                 | —                  | 1CT:2CT & 1CT:2.3CT                    | 1.20 & 1.20  | 30 & 30                   | .80 & .80               | 0.90 & 0.90     | BH/1              | 6-8, 14-16   |
| T1021 <sup>I</sup>    | —                  | 2CT:1/1.26 & 2CT:1/1.26                | 1.50 & 1.50  | 40 & 40                   | .50 & .50               | 0.70 & 0.70     | BH/1              | 1-3, 11-9    |
| T1075 <sup>I</sup>    | —                  | 2CS:1.57/2 & 2CS:1.57/2                | 1.50 & 1.50  | 40 & 40                   | .50 & .50               | 0.70 & 0.70     | BH/4              | 1-2, 5-6     |
| T1190                 | —                  | 1CT:1CT & 1CT:1.36CT                   | 1.20 & 1.20  | 30 & 30                   | .60 & .60               | 0.70 & 0.70     | BH/1              | 16-14, 6-8   |
| T1137                 | TX1287             | 1CT:2.42CT & 1CT:2.42CT                | 1.20 & 1.20  | 25 & 25                   | .60 & .60               | 0.70 & 0.70     | BH/1              | 1-3, 6-8     |
| —                     | T1146              | 1:2/2.4 & 1:0.79/1                     | 1.00 & 1.00  | 35 & 35                   | 1.00 & 1.00             | 0.80 & 0.80     | BH/5              | 1-3, 6-8     |
| T1286                 | —                  | 1CT:2.4CT & 1CT:2.4CT                  | 1.20 & 1.20  | 15 & 15                   | .30 & .30               | 0.30 & 0.30     | BH/1              | 1-3, 6-8     |
| —                     | TX1317             | 1:2CT & 1:2CS                          | 1.20 & 1.20  | 35 & 35                   | .50 & 1.00              | 1.00 & 1.00     | BH/6              | 1-3, 11-9    |
| —                     | TX1189             | 1:1.36CT & 1:2CT                       | 1.20 & 1.20  | 30 & 30                   | .60 & .60               | 1.00 & 1.00     | BH/7              | 16-14, 6-8   |
| —                     | TX1188             | 1CT:2CT & 1CT:2CT                      | 1.20 & 1.20  | 30 & 30                   | .60 & .60               | 0.70 & 0.70     | BH/1              | 1-3, 6-8     |
| —                     | TX1187             | 1CT:2CT & 1:1                          | 1.20 & 1.20  | 30 & 30                   | .60 & .60               | 0.70 & 0.70     | BH/8              | 1-3, 6-8     |
| —                     | TX1088             | 1CT:2CT & 1CT:2.42CT                   | 1.20 & 1.20  | 35 & 35                   | .80 & .80               | 1.00 & 1.00     | BH/1              | 1-3, 6-8     |
| —                     | TX1089             | 1CT:1CT & 1CT:1CT                      | 1.20 & 1.20  | 30 & 30                   | .80 & .80               | 0.70 & 0.70     | BH/1              | 1-3, 6-8     |
| —                     | TX1098             | 1CT:1.26CT & 1CT:1.26CT                | 1.20 & 1.20  | 30 & 30                   | .60 & .60               | 0.70 & 0.70     | BH/1              | 1-3, 6-8     |
| —                     | TX1099             | 1CT:1:0.8 & 1CT:1:0.8                  | 1.20 & 1.20  | 30 & 30                   | .80 & .80               | 1.00 & 1.00     | BH/4              | 16-14, 11-9  |
| —                     | TX1186             | 1CT:1.58:2 & 1:1.65:2                  | 1.20 & 1.20  | 30 & 30                   | .80 & .80               | 1.00 & 1.00     | BH/9              | 2-4, 6-7     |
| —                     | TX1467             | 1CT:1:1 & 1CT:1:1                      | 1.20 & 1.20  | 30 & 30                   | .80 & .80               | 1.00 & 1.00     | BH/4              | 16-14, 11-9  |

NOTE: Standard (STD) operating temperature range is 0°C to 70°C. Extended (EXT) operating temperature range is -40°C to +85°C. RoHS-6 compliant parts can be ordered by adding an "NL" suffix to the part number (i.e. PE-65861 becomes PE-65861NL). (See Pages 6 and 7 for Table Notes)

### Mechanical

### Schematics

**Weight** ..... 1.0 grams  
**Tape & Reel** ..... 600/reel  
**Tube** ..... 40/tube

**Dimensions:** Inches/mm  
 Unless otherwise specified, all tolerances are ± .010/.25

USA 858 674 8100 • Germany 49 7032 7806 0 • Singapore 65 6287 8998 • Shanghai 86 21 32181071 • China 86 755 33966678 • Taiwan 886 3 4643715

# T1/CEPT/ISDN-PRI TRANSFORMERS

## Single Reinforced Insulation, 3KVrms

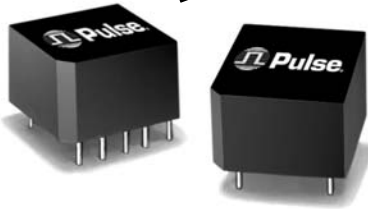

- Certified for reinforced insulation per UL
- For T1/CEPT line interfaces
- Matched to leading transceiver ICs
- Designed to meet ITU-T G.703
- RoHS compliant versions available upon request

### Electrical Specifications @ 25°C — Operating Temperature 0°C to 70°C (Unless Otherwise Noted)

| Part Number           | Turns Ratio <sup>B</sup><br>(±5%) | OCL <sup>B</sup><br>(mH MIN) | C <sub>WWW</sub><br>(pF MAX) | L <sub>L</sub><br>(μH MAX) | DCR Pri<br>(Ω MAX) | DCR Sec<br>(Ω MAX) | Safety Agency Recognition <sup>10</sup> | Package/Schematic | Primary Pins |
|-----------------------|-----------------------------------|------------------------------|------------------------------|----------------------------|--------------------|--------------------|---|-------------------|--------------|
| PE-65830              | 1.27CS:1                          | .800                         | 15                           | 0.70                       | 0.50               | 0.35               | C,T,U,B                                 | IS/3              | 1-5          |
| PE-65831              | 1CS:1                             | .800                         | 15                           | 0.70                       | 0.50               | 0.45               | C,T,U,B                                 | IS/3              | 1-5          |
| PE-65832              | 1:1.36CT                          | 1.20                         | 35                           | 0.60                       | 0.70               | 0.90               | C,T,U,B                                 | IS/4              | 10-6         |
| PE-65833 <sup>A</sup> | 1CT:2CT                           | 1.20                         | 20                           | 0.30-0.55                  | 0.50               | 0.90               | C,T,U,B                                 | IS/1              | 1-5          |
| PE-65834              | 1:1                               | 1.20                         | 20                           | 0.50                       | 0.50               | 0.50               | C,T,U,B                                 | IS/2              | 1-5          |
| PE-65835              | 1CT:2CT                           | 1.20                         | 15                           | 0.80                       | 0.70               | 1.10               | C,T,U,B                                 | IS/1              | 1-5          |
| PE-65836              | 1CT:3CT:1                         | .600                         | 30                           | 0.80                       | 0.70               | 1.70               | C,T,U,B                                 | IS/5              | 1-3          |
| PE-65837 <sup>E</sup> | 1:1.08/1.36                       | 1.50                         | 20                           | 0.60                       | 0.70               | 0.90               | C,T,U,B                                 | IS/4              | 10-6         |
| PE-65838              | 1:1.14CT                          | 1.50                         | 30                           | 1.00                       | 0.70               | 0.90               | C,T,U,B                                 | IS/4              | 10-6         |
| PE-65839 <sup>E</sup> | 1:1/1.26                          | 1.50                         | 35                           | 0.60                       | 0.70               | 1.10               | C,T,U,B                                 | IS/4              | 10-6         |
| PE-68646 <sup>E</sup> | 1:1.58/2                          | 1.50                         | 20                           | 0.70                       | 0.70               | 1.20               | C,T,U,B                                 | IS/4              | 10-6         |
| PE-68788              | 1CT:1.41CT                        | 1.20                         | 20                           | 0.80                       | 0.60               | 0.80               | T,U,B                                   | IS/1              | 10-6         |

NOTE: RoHS-6 compliant parts can be ordered by adding an "NL" suffix to the part number (i.e. PE-65830 becomes PE-65830NL).

(See Pages 6 and 7 for Table Notes)

## Mechanical

## Schematics

### IS

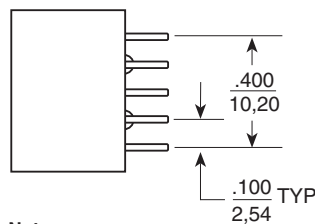
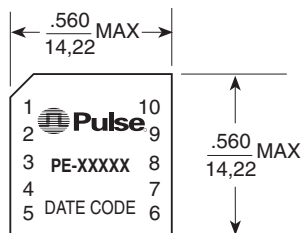

**Notes:**  
Leads are 22 AWG solderable.  
Unused pins not provided.

**Weight** ..... 4 grams  
**Tube** ..... .35/tube

**Dimensions:** Inches  
mm  
Unless otherwise specified,  
all tolerances are ± .010  
0,25

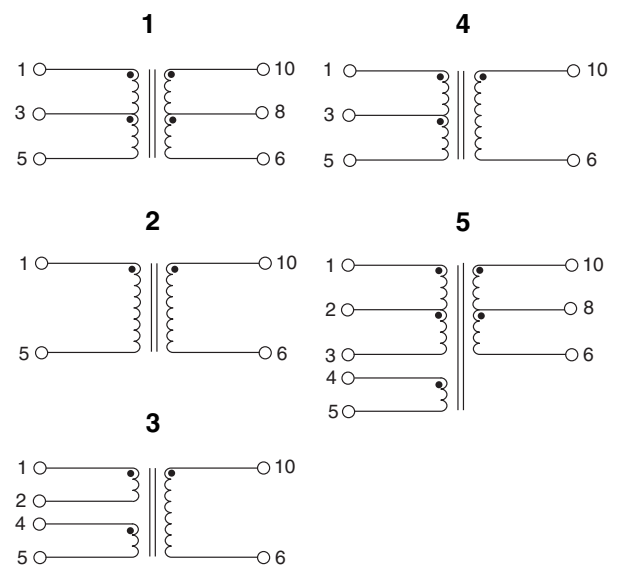
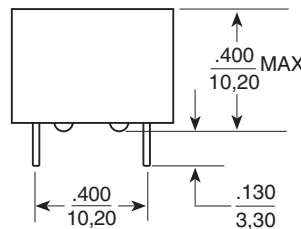

# T1/CEPT/ISDN-PRI TRANSFORMERS

## Single Through Hole, 1500Vrms

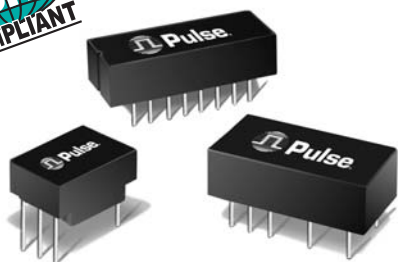

- Extended and standard temperature range
- Dual and single through hole models available
- Models matched to leading transceiver ICs
- UL recognized
- Isolation Voltage: 1500Vrms MIN
- RoHS compliant versions available upon request

### Electrical Specifications @ 25°C

| Part Number  | Turns Ratio <sup>B</sup><br>(Pri:Sec ±5%) | OCL @ 25°C<br>(mH MIN) | C <sub>w/w</sub><br>(pF MAX) | L <sub>L</sub><br>(μH MAX) | DCR Pri<br>(Ω MAX) | DCR Sec<br>(Ω MAX) | Package/<br>Schematic | Primary<br>Pins |
|--|---|------------------------|------------------------------|----------------------------|--------------------|--------------------|-----------------------|-----------------|
| <b>STANDARD TEMPERATURE RANGE SINGLE TRANSFORMERS – OPERATING TEMPERATURE 0°C TO +70°C</b>     |   |                        |                              |                            |                    |                    |                       |                 |
| PE-64931   | 1:1:1 (1:2CS)                             | 1.20                   | 25                           | 0.50                       | 0.70               | 0.70 & 0.70        | HC/2                  | 1-2             |
| PE-64933   | 1CT:3CT                                   | 1.20                   | 30                           | 0.50                       | 0.70               | 1.60               | HC/4                  | 1-5             |
| PE-64934   | 1:1                                       | 1.20                   | 25                           | 0.50                       | 0.70               | 0.70               | HC/1                  | 1-2             |
| PE-64936   | 1CT:1                                     | 1.20                   | 25                           | 0.80                       | 0.70               | 0.70               | HC/3                  | 1-5             |
| PE-64937   | 1:1.36                                    | 1.20                   | 35                           | 0.80                       | 0.70               | 0.80               | HC/1                  | 5-6             |
| PE-64940   | 1.26CS:1 (1:1:1.58)                       | 0.30                   | 30                           | 0.60                       | 0.80               | 0.60               | HC/2                  | 1-4             |
| PE-64941 <sup>D</sup>  | 1CS:1                                     | 0.80                   | 30                           | 0.60                       | 0.80               | 0.60               | HC/2                  | 1-4             |
| PE-64942   | 1CS:1.31                                  | 0.80                   | 30                           | 0.40                       | 0.80               | 0.60               | HC/2                  | 1-4             |
| PE-64943 <sup>A</sup>  | 1CT:2CT                                   | 1.20                   | 30                           | 0.30-0.55                  | 0.70               | 1.20               | HC/4                  | 1-5             |
| PE-65351   | 1:2CT                                     | 1.20                   | 40                           | 0.50                       | 0.70               | 1.30               | HC/3                  | 2-6             |
| PE-65363   | 1:4CT                                     | 0.50                   | 40                           | 1.00                       | 0.50               | 1.50               | HC/5                  | 1-5             |
| PE-65379   | 1:1.14CT                                  | 1.20                   | 35                           | 0.80                       | 0.70               | 0.80               | HC/5                  | 1-5             |
| PE-65388   | 1:1.15CT                                  | 1.50                   | 35                           | 0.60                       | 0.70               | 0.90               | HC/3                  | 2-6             |
| PE-65389 <sup>E</sup>  | 1:1/1.26                                  | 1.50                   | 40                           | 0.40                       | 0.70               | 0.90               | HC/3                  | 2-6             |
| PE-65415   | 1CT:2CT                                   | 1.20                   | 30                           | 0.50                       | 0.70               | 1.20               | HC/4                  | 1-5             |
| PE-65558   | 1:2.3CT                                   | 1.20                   | 35                           | 0.80                       | 0.70               | 1.40               | HC/5                  | 1-5             |
| PE-65586   | 1:1.36CT                                  | 1.20                   | 35                           | 0.80                       | 0.70               | 0.90               | HC/5                  | 1-5             |
| PE-65755   | 1CT:1CT                                   | 1.20                   | 25                           | 0.80                       | 0.80               | 0.80               | HC/4                  | 1-5             |
| PE-68644   | 1CT:1                                     | 0.70                   | 20                           | 0.70                       | 0.20               | 0.80               | HC/3                  | 1-5             |
| PE-68645   | 1:1.36CT                                  | 0.70                   | 20                           | 0.70                       | 0.50               | 0.40               | HC/5                  | 1-5             |
| T1054  | 1:1.5CT                                   | 1.20                   | 30                           | 0.60                       | 0.70               | 1.00               | HC/3                  | 2-6             |
| T1249  | 1:1.26CT                                  | 1.20                   | 60                           | 0.80                       | 0.90               | 1.00               | HC/4                  | 2-6             |
| <b>EXTENDED TEMPERATURE RANGE SINGLE TRANSFORMERS 1 – OPERATING TEMPERATURE -40°C TO +85°C</b> |   |                        |                              |                            |                    |                    |                       |                 |
| PE-65340   | 1:1.36                                    | 1.20                   | 35                           | 0.80                       | 0.90               | 1.20               | HC/1                  | 5-6             |
| PE-65770   | 1:1.15CT                                  | 1.50                   | 40                           | 0.80                       | 0.90               | 1.00               | HC/3                  | 2-6             |
| PE-65771   | 1CT:2CT                                   | 1.20                   | 50                           | 0.60                       | 1.00               | 2.00               | HC/4                  | 2-6             |
| PE-65778   | 1CT:1CT                                   | 1.20                   | 40                           | 1.00                       | 1.00               | 1.00               | HC/4                  | 1-5             |
| PE-68600   | 1CT:3CT                                   | 1.20                   | 60                           | 0.80                       | 0.90               | 2.70               | HC/4                  | 1-5             |
| PE-68664 <sup>E</sup>  | 1:1/1.26                                  | 1.50                   | 50                           | 0.80                       | 0.90               | 1.10               | HC/3                  | 2-6             |
| TX1252   | 1CT:1                                     | 1.20                   | 40                           | 1.00                       | 1.00               | 1.00               | HC/3                  | 1-5             |

NOTE: RoHS-6 compliant parts can be ordered by adding an "NL" suffix to the part number (i.e. PE-64931 becomes PE-64931NL).

(See Pages 6 and 7 for Table Notes)

### Mechanical

### Schematics

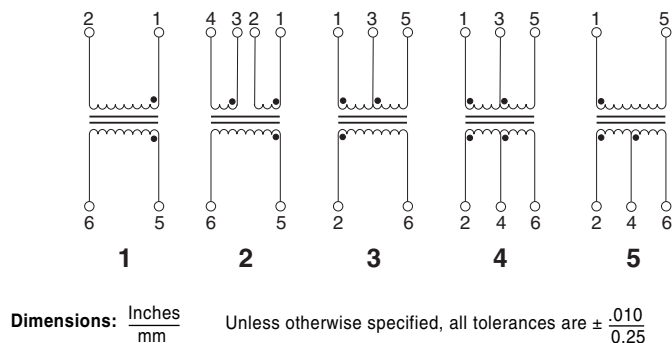
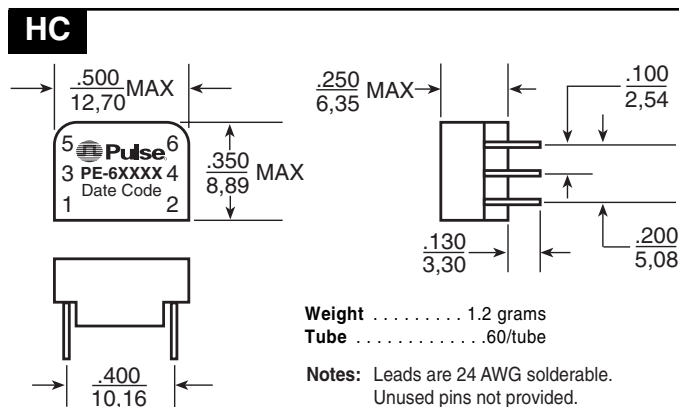

USA 858 674 8100 • Germany 49 7032 7806 0 • Singapore 65 6287 8998 • Shanghai 86 21 32181071 • China 86 755 33966678 • Taiwan 886 3 4643715

# T1/CEPT/ISDN-PRI TRANSFORMERS

## Dual Through Hole, 1500Vrms



### Electrical Specifications @ 25°C

| Part Number   | Turns Ratio <sup>B</sup><br>(Pri:Sec ±5%) | OCL @ 25°C<br>(mH MIN) | C <sub>w/w</sub><br>(pF MAX) | L <sub>L</sub><br>(μH MAX) | DCR Pri<br>(Ω MAX) | DCR Sec<br>(Ω MAX) | Package/<br>Schematic | Primary<br>Pins |
|---|---|------------------------|------------------------------|----------------------------|--------------------|--------------------|-----------------------|-----------------|
| <b>STANDARD TEMPERATURE RANGE DUAL TRANSFORMERS – OPERATING TEMPERATURE 0°C TO +70°C</b>                |   |                        |                              |                            |                    |                    |                       |                 |
| PE-64951  | 1:2CT & 1:2CT                             | 1.20 & 1.20            | 35 & 35                      | 0.50 & 0.50                | 0.70 & 0.70        | 1.20 & 1.20        | HD/1                  | 14-12, 5-7      |
| PE-64952  | 1:2CT & 1:1.36                            | 1.20 & 1.20            | 35 & 35                      | 0.50 & 0.80                | 0.80 & 0.80        | 1.20 & 1.00        | HD/2                  | 14-12, 5-7      |
| PE-64953  | 1:2CT & 1:2CT                             | 2.00 & 2.00            | 50 & 50                      | 0.60 & 0.60                | 1.00 & 1.00        | 2.00 & 2.00        | HD/3                  | 14-12, 10-8     |
| PE-64954 <sup>A</sup>   | 1CT:2CT & 1:1                             | 1.20 & 1.20            | 30 & 30                      | 0.30-0.55 & 0.50           | 0.70 & 0.70        | 1.20 & 0.70        | HD/4                  | 1-3, 5-7        |
| PE-64955  | 1:1.26CT & 1.58:1                         | 0.80 & 0.80            | 30 & 30                      | 0.50 & 0.50                | 0.60 & 0.60        | 0.70 & 0.30        | HD/5                  | 1-3, 5-7        |
| PE-64956  | 1:1CT & 2:1                               | 0.80 & 0.80            | 30 & 30                      | 0.60 & 0.60                | 0.50 & 0.50        | 0.50 & 0.20        | HD/5                  | 1-3, 5-7        |
| PE-64957  | 1CT:1.31 & 2.62:1                         | 1.20 & 1.20            | 30 & 30                      | 0.80 & 0.80                | 0.60 & 0.60        | 0.50 & 0.30        | HD/5                  | 1-3, 5-7        |
| PE-65565  | 1:1.15CT & 1:2CT                          | 1.50 & 1.20            | 35 & 40                      | 0.60 & 0.50                | 0.70 & 0.70        | 1.10 & 1.30        | TD/1                  | 14-12, 5-7      |
| PE-65566 <sup>E</sup>   | 1:1/1.26 & 1:2CT                          | 1.50 & 1.20            | 40 & 40                      | 0.50 & 0.40                | 0.70 & 0.70        | 0.90 & 1.30        | TD/1                  | 14-12, 5-7      |
| <b>EXTENDED TEMPERATURE RANGE DUAL TRANSFORMERS <sup>1</sup> – OPERATING TEMPERATURE -40°C TO +85°C</b> |   |                        |                              |                            |                    |                    |                       |                 |
| PE-65567  | 1:1.15CT & 1:2CT                          | 1.50 & 1.20            | 40 & 60                      | 0.80 & 0.80                | 0.90 & 0.90        | 1.00 & 1.70        | TD/1                  | 14-12, 5-7      |
| PE-65568 <sup>E</sup>   | 1:1/1.26 & 1:2CT                          | 1.50 & 1.20            | 50 & 60                      | 0.80 & 0.80                | 0.90 & 0.90        | 1.00 & 1.70        | TD/1                  | 14-12, 5-7      |
| PE-65774  | 1CT:2CT & 1:1.36CT                        | 1.20 & 1.20            | 50 & 50                      | 0.96 & 0.80                | 1.00 & 1.00        | 1.70 & 1.20        | TD/7                  | 14-12, 5-7      |
| PE-68618 <sup>G</sup>   | 1CT:1CT & 3CT:1CT:25                      | 1.20 & 32.0            | 40 & 65                      | 0.80 & 0.80                | 1.00 & 3.00        | 1.00 & 1.20        | BD/6                  | 1-3, 11-9       |
| PE-64950 <sup>G</sup>   | 1CT:1CT & 1CT:3CT:1                       | 1.20 & 0.60            | 50 & 50                      | 0.80 & 0.80                | 1.00 & 0.80        | 1.00 & 2.00        | BD/6                  | 1-3, 4-6        |

(See Pages 6 and 7 for Table Notes)

### Mechanicals

**TD**  
DUAL

Weight . . . . . 2.6 grams  
Tube . . . . . .25/tube

**HD**  
DUAL

Weight . . . . . 2.3 grams  
Tube . . . . . .25/tube

**BD**  
DUAL

Weight . . . . . 3.1 grams  
Tube . . . . . .25/tube

Note: Leads are 24 AWG solderable.

Dimensions: Inches  
mm  
Unless otherwise specified all tolerances are ±.010  
0,25

### Schematics

1: PE-64951, PE-64952, PE-64953, PE-64954, PE-64955, PE-64956, PE-64957

2: PE-64954, PE-64955, PE-64956, PE-64957

3: PE-64951, PE-64952, PE-64953, PE-64954, PE-64955, PE-64956, PE-64957

4: PE-64951, PE-64952, PE-64953, PE-64954, PE-64955, PE-64956, PE-64957

5: PE-64951, PE-64952, PE-64953, PE-64954, PE-64955, PE-64956, PE-64957

6: PE-64951, PE-64952, PE-64953, PE-64954, PE-64955, PE-64956, PE-64957

7: PE-64951, PE-64952, PE-64953, PE-64954, PE-64955, PE-64956, PE-64957

USA 858 674 8100 • Germany 49 7032 7806 0 • Singapore 65 6287 8998 • Shanghai 86 21 32181071 • China 86 755 33966678 • Taiwan 886 3 4643715

www.pulseeng.com

5

T608.S (4/08)

Downloaded from Elcodis.com electronic components distributor



# T1/CEPT/ISDN-PRI TRANSFORMERS

## Application Notes



- Extended Temperature Range Models** — For extended temperature range transformers (-40°C to +85°C operating temperature range), OCL (Open Circuit Inductance for the primary winding) is specified at both -40°C and +25°C. At -40°C, OCL is 600 µH minimum for all low temperature models with the exception of PE-68827 which is 800 µH minimum and PE-65836 which is 300 µH minimum. All other parameters are specified at +25°C only. Standard temperature range is 0°C to +70°C.
- ET Product** — All coils have an ET product of 10 V-µsec minimum.
- Flammability** — Materials used in the products are recognized as UL94-VO approved. Products meet the requirements of IEC 695-2-2 (Needle Flame Test).
- Balance Characteristics** — The transformers meet the requirements for longitudinal balance of FCC part 68.
- Common Mode Rejection Ratio** — the CMRR for all transformers is better than 50 dB at 1 MHz. A typical test circuit is shown below.

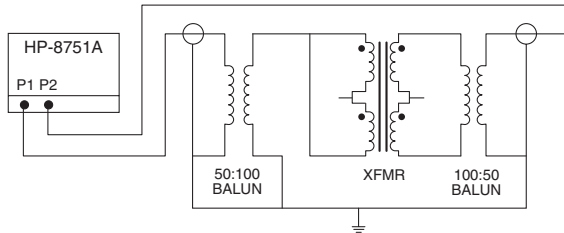

- Crosstalk Attenuation** — In the dual packages, which contain transmit and receive transformers side by side, sufficient crosstalk attenuation is achieved by the inherent characteristics of the toroid cores as well as by their proper positioning. The crosstalk attenuation is typically 50 dB or better from 100kHz to 10MHz. This result was established with the test circuit shown below.

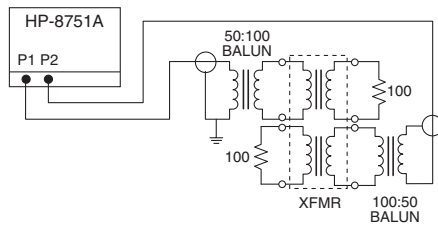

- Return Loss** — ITU-T G.703 and European national regulatory documents specify minimum return loss levels. The transformers will allow these limits to be complied within the situations where they are applicable.

| Frequency   | 50-100kHz | 100kHz-2 MHz | 2-3MHz |
|-------------|-----------|--------------|--------|
| Return Loss |           |              |        |
| XMIT        | 9 dB      | 15dB         | 11dB   |
| REC         | 12 dB     | 18dB         | 14dB   |

- Surge Voltage Capability** — All transformers and chokes meet surge voltage tests according to the most stringent regulatory documents when system designs include the proper voltage and current suppression devices:

Metallic Voltage: 800V peak, 10/560µsec  
 Longitudinal Voltage: 2,400V peak, 10/700µsec

- Isolation Voltage** — 100% of transformers are tested during production to the specified isolation voltage level.
- Safety Agency Recognition** — Parts listed as "Recognized" or "Certified" meet Underwriter Laboratories, UL 1459 and UL 1950 per file E133523 (S).

**Transformers with Reinforced Insulation according to IEC950 series PE-68630—PE-68788 (pg. 3) are certified by the following organizations:**

| Code | Certificate Information   |
|------|---|
| T    | TÜV, EN 60 950/EN 41003, Cert. R9371358, reinforced insulation. |
| U    | UL 1459/UL1950, File E133523 (S), reinforced insulation.        |

- General Information** — The transformers are specifically designed for use in 1.544 Mbps (T1), 2.048 Mbps (CEPT) and ISDN Primary rate (PRI) interface applications. They are matched to the majority of the line interface transceiver ICs currently available. Use of the proper transformer allows the interface circuit to comply with ITU-T G.703 and other standards regarding pulse waveform, return loss, and balance.

- Common Mode Chokes** — The "high-frequency" 4-lines common mode chokes shown in this data sheet provide an effective means of compliance with national and international regulations on EMI. They are designed to be used in conjunction with Pulse's T1/CEPT transformers as shown in the typical application below. Crosstalk is typically -70dB at 1MHz and -55dB at 10MHz.

### Typical Application

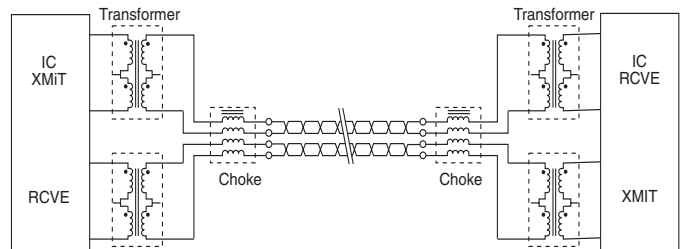

#### NOTES FROM TABLES (pages 1 through 6):

- Toleranced leakage inductance: .30µH min to .55µH MAX.
- OCL (primary inductance) and LL (leakage inductance) are measured at the primary winding. Turns ratio is specified primary: secondary. (CT = Center Tap; CS = Split Center Tap).
- To make a 1CT:1 ratio from a 1CT:2CT ratio, use only one half of the secondary (2CT) winding.
- For Reinforced 3kVrms Dual SMT Transformers, refer to data sheet T617. For Quad SMT Transformers refer to data sheet T615. For Octal SMT Transformers refer to data sheet T622.
- Dual Ratio Transformers — These transformers have tapped secondary windings to provide two turns ratios (T/R). Use the entire primary winding and connect the secondary pins listed below to obtain the desired turns ratio:

| Part Number | Turns Ratio 1 | Secondary Pins | Turns Ratio 2 | Secondary Pins |
|-------------|---------------|----------------|---------------|----------------|
| PE-65837    | 1:1.08        | 3-5            | 1:1.36        | 1 - 5          |
| PE-65839    | 1:1           | 3-5            | 1:1.26        | 1 - 5          |
| PE-65866    | 1:1           | 2-3            | 1:1.26        | 1 - 3          |
| PE-68646    | 1:1.58        | 3-5            | 1:2           | 1 - 5          |
| PE-65389    | 1:1           | 3-5            | 1:1.26        | 1 - 5          |
| PE-65566    | 1:1           | 2-3            | 1:1.26        | 1 - 3          |
| PE-65568    | 1:1           | 2-3            | 1:1.26        | 1 - 3          |
| PE-68866    | 1:1           | 2-3            | 1:1.26        | 1 - 3          |
| PE-68826    | 1:1           | 2-3            | 1:1.26        | 1 - 3          |
| PE-68664    | 1:1           | 3-5            | 1:1.26        | 1 - 5          |
| PE-68836    | 1:1           | 2-3/5-6        | 1:1.26        | 1-3/4-6        |

F. Standard packaging for surface mount "AN" and "LA" packages is anti-static tubes. Optional Tape & Reel packaging can be ordered by adding "T" suffix to the part number, (i.e. PE-65857T).

- PE-68618 and PE-64950: The fault locate winding is (7-8).
- Safety Agency approvals pending.
- The turns ratio of these devices have been designed, in conjunction with semiconductor vendor recommendations, to allow connections to various terminations (e.g. 75 or 120Ω with the same transformer). For example T1075 can be used with the Siemens PEB 2235 to achieve connection to the 75 or 120Ω cable. For 75 Ω termination, the PEB 2235 requires the following turns ratio: 1:1.57 (Tx) and 1:1.26 (Rx) which can be achieved using pins (1-2):(15-16) for Tx and (10-11):(5-8) for Rx. For 120Ω, the following turns ratio are required: 1:2 (Tx) and 1:1 (Rx), which are pins (1-2):(16-14) for Tx and (9-11):(5-8) for Rx on the T1075.

# COMMON MODE CHOKES FOR TELECOM APPLICATIONS

## For EMI Reduction



### Electrical Specifications @ 25°C — Operating Temperature 0°C to 70°C

| Pulse Part Number                                 | Turns Ratio (±5%) | OCL (µH MIN) | Package/Schematic    |
|---|-------------------|--------------|----------------------|
| <b>HIGH FREQUENCY COMMON MODE CHOKES, 4-LINES</b> |                   |              |                      |
| PE-65554  | 1:1:1:1           | 24.0         | IN/1 (Through Hole)  |
| PE-65555  | 1:1:1:1           | 8.0          | IN/1 (Through Hole)  |
| PE-65854  | 1:1:1:1           | 47.0         | SH/1 (Surface Mount) |
| PE-65857  | 1:1:1:1           | 24.0         | LA/2 (Surface Mount) |

NOTE: For additional Common Mode Chokes, refer to data sheet G002.

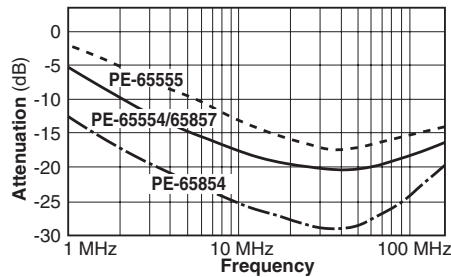

Typical common mode attenuation for high frequency common mode chokes based on a 100 Ω system.

### Schematics

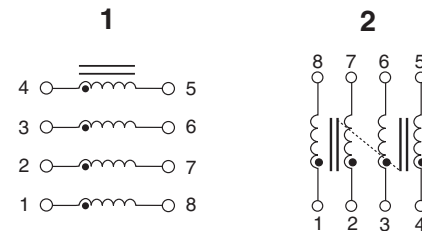

### Mechanicals

#### SH

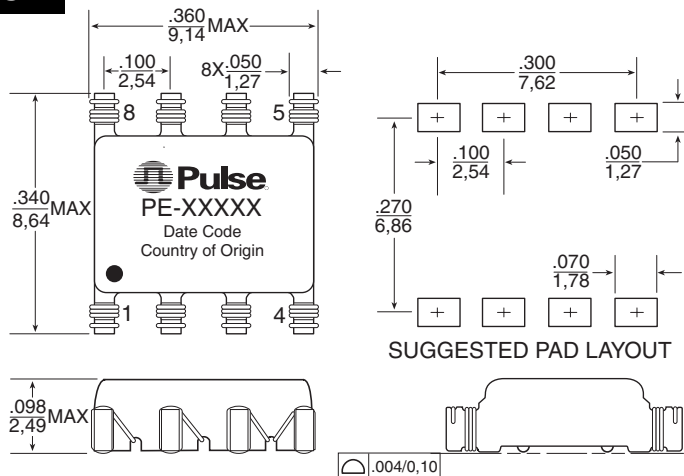

#### LA

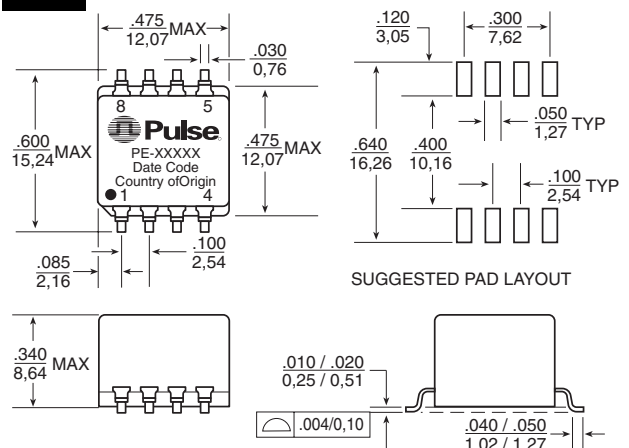

#### IN

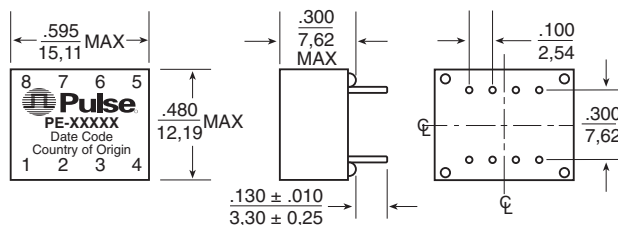

|             | SH                 | LA                | IN                 |
|-------------|--------------------|-------------------|--------------------|
| Weight      | . . . . .0.3 grams | . . . . .2 grams  | . . . . .2.5 grams |
| Tape & Reel | . . . . .1500/reel | . . . . .250/reel | . . . . .(N/A)     |
| Tube        | . . . . .25/tube   | . . . . .30/tube  | . . . . .35/tube   |

Dimensions:  $\frac{\text{Inches}}{\text{mm}}$

Unless otherwise specified all tolerances are  $\pm \frac{.010}{0.25}$

### For More Information:

**Pulse Worldwide Headquarters**  
12220 World Trade Dr.  
San Diego, CA 92128  
U.S.A.  
[www.pulseeng.com](http://www.pulseeng.com)

**Pulse European Headquarters**  
Einsteinstrasse 1  
D-71083 Herrenberg  
Germany

**Pulse China Headquarters**  
B402, Shenzhen Academy of  
Aerospace Technology Bldg.  
10th Kejian Rd.  
High-Tech Zone  
Nanshan District  
Shenzhen, PR China 518057  
TEL: 86 755 33966678  
FAX: 86 755 33966700

**Pulse North China**  
Room 1503  
XinYin Building  
No. 888 YiShan Rd.  
Shanghai 200233  
China  
TEL: 86 21 32181071  
FAX: 86 21 32181396

**Pulse South Asia**  
150 Kampong Ampat  
#07-01/02  
KA Centre  
Singapore 368324  
TEL: 65 6287 8998  
FAX: 65 6280 0080

**Pulse North Asia**  
No. 26  
Kao Ching Rd.  
Yang Mei Chen  
Taoyuan Hsien  
Taiwan, R. O. C.  
32667  
TEL: 886 3 4643715  
FAX: 886 3 4641911

TEL: 858 674 8100  
FAX: 858 674 8262

TEL: 49 7032 7806 0  
FAX: 49 7032 7806 12

TEL: 86 21 32181071  
FAX: 86 21 32181396

TEL: 65 6287 8998  
FAX: 65 6280 0080

TEL: 886 3 4643715  
FAX: 886 3 4641911

Performance warranty of products offered on this data sheet is limited to the parameters specified. Data is subject to change without notice. Other brand and product names mentioned herein may be trademarks or registered trademarks of their respective owners. © Copyright, 2008. Pulse Engineering, Inc. All rights reserved.

[www.pulseeng.com](http://www.pulseeng.com)