





10/100/1000BASE-T SINGLE & DUAL-PORT TRANSFORMER MODULES

Military / Aerospace Grade



-  Compliant with IEEE 802.ab for 1000Base-T
-  350µH OCL with 8mA bias at extended temperatures
-  Operating and storage temperature:
1000B-5001/5002/5003: -40°C to +85°C
1000B-5001X/5002X/5003X: -55°C to +125°C
-  IC grade transfer-molded package withstands 235°C peak temperature profile RoHS version withstands 245°C

Electrical Specifications @ 25°C

Part Number ¹	Insertion Loss (dB MIN)	Return Loss (dB MAX)				Crosstalk (dB MAX)			CM to CM Rejection Ratio (dB MAX)			DM to CM Rejection Ratio (dB MAX)		
		0.1-100 MHz	30 MHz	60 MHz	80 MHz	100 MHz	30 MHz	60 MHz	100 MHz	30 MHz	60 MHz	100 MHz	30 MHz	60 MHz
1000B-5001	-1.20	-18	-12	-10	-10	-43	-37	-33	-40	-35	-30	-43	-37	-33
1000B-5001X	-1.40	-18	-12	-10	-8	-43	-37	-33	-40	-35	-30	-43	-37	-33
1000B-5002	-1.20	-18	-14	-12	-10	-43	-37	-33	-40	-35	-30	-43	-37	-33
1000B-5002X	-1.20	-18	-14	-12	-10	-43	-37	-33	-40	-35	-30	-43	-37	-33
1000B-5003	-1.20	-18	-14	-11	-9	-43	-37	-33	-40	-35	-30	-43	-37	-33
1000B-5003X	-1.20	-18	-14	-11	-9	-43	-37	-33	-40	-35	-30	-43	-37	-33

Note: 1. Add suffix NL for RoHS compliant part; i.e. 1000B-5001 becomes 1000B-5001NL.

Mechanical

1000B-5001/X

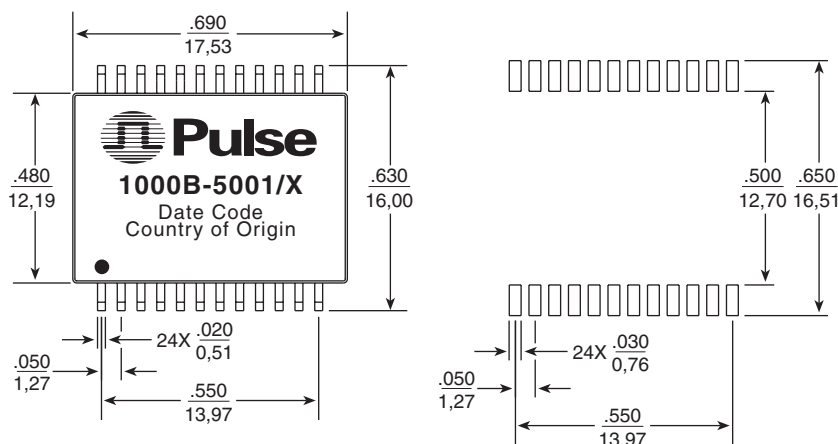

Weight 3.0 grams
 Tape and Reel 300/reel
 Tube25/tube

Dimensions: Inches
 mm
 Unless otherwise specified,
 all tolerances are ± .010
 0,25

SUGGESTED PAD LAYOUT

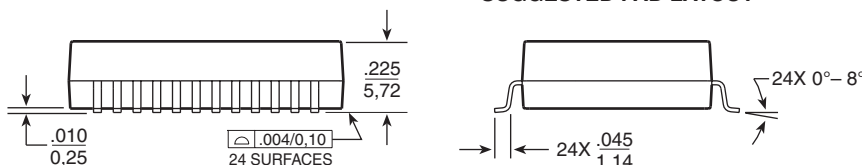

10/100/1000BASE-T SINGLE & DUAL-PORT TRANSFORMER MODULES

Military / Aerospace Grade



Mechanicals

1000B-5002/X

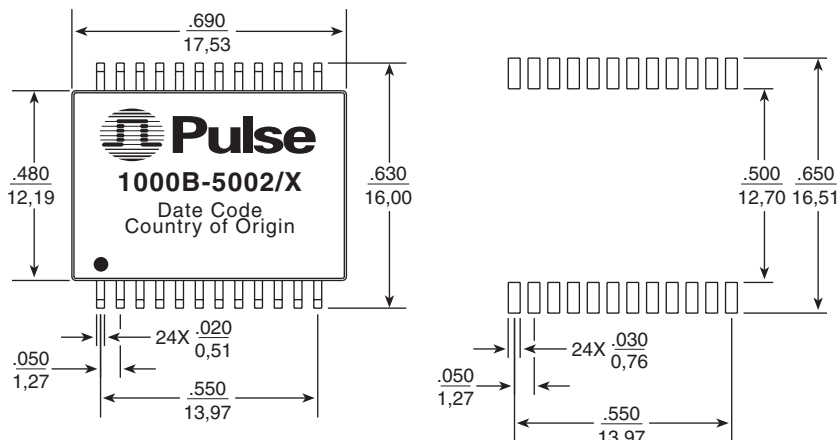

Weight2.6 grams
Tape and Reel 300/reel
Tube25/tube

Dimensions: $\frac{\text{Inches}}{\text{mm}}$
Unless otherwise specified,
all tolerances are $\pm \frac{.010}{0,25}$

SUGGESTED PAD LAYOUT

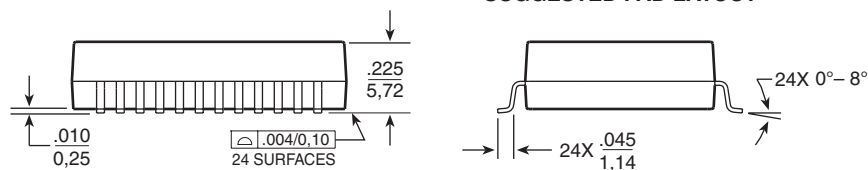

1000B-5003/X

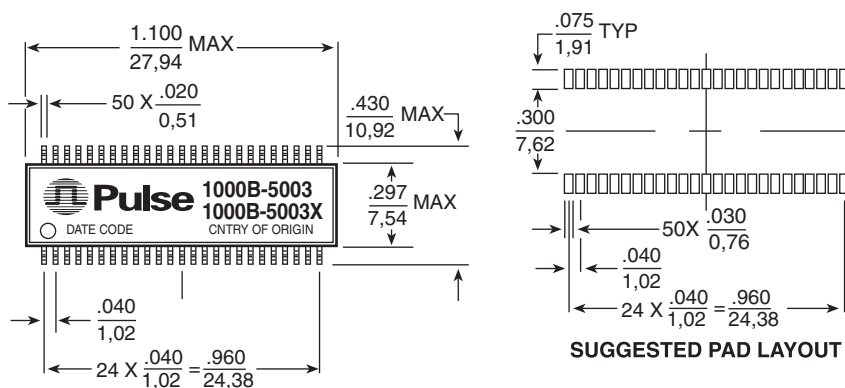

Weight3.5 grams
Tape and Reel 250/reel
Tube15/tube

Dimensions: $\frac{\text{Inches}}{\text{mm}}$
Unless otherwise specified,
all tolerances are $\pm \frac{.010}{0,25}$

SUGGESTED PAD LAYOUT

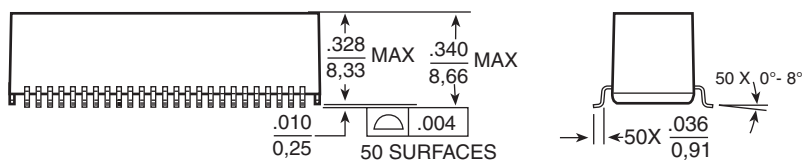

10/100/1000BASE-T SINGLE & DUAL-PORT TRANSFORMER MODULES

Military / Aerospace Grade



Electrical Schematic

1000B-5001/X

CHANNEL 1

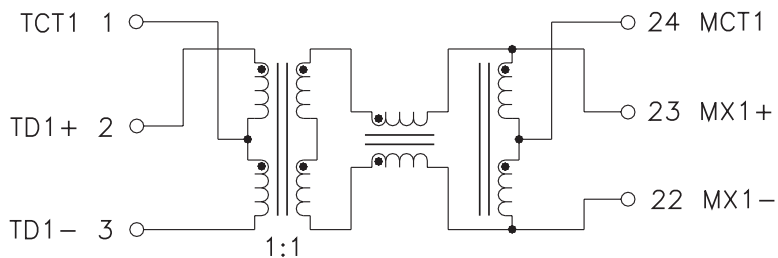

CHANNEL 2

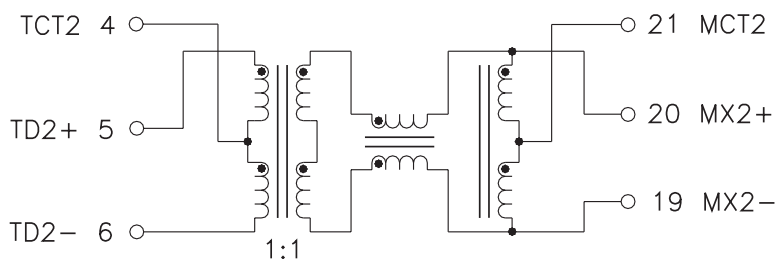

CHANNEL 3

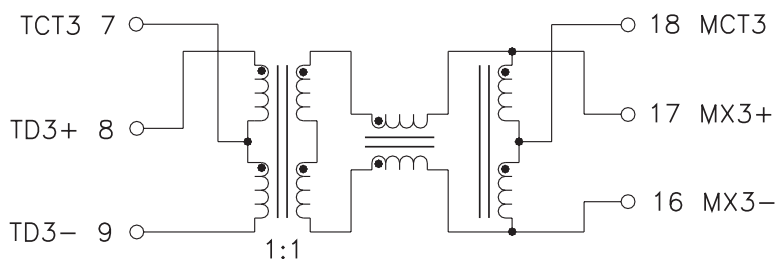

CHANNEL 4

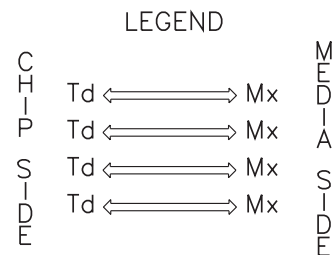
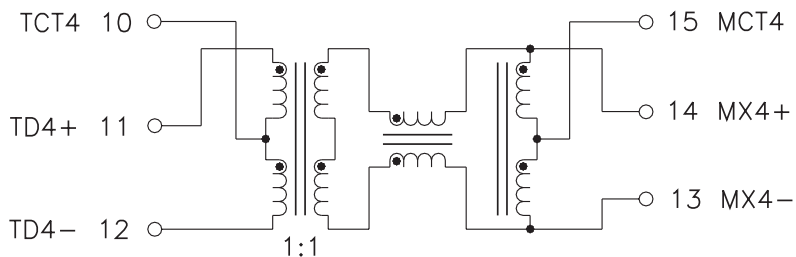

ALL CHANNELS ARE IN PHASE BETWEEN INPUT AND OUTPUT

10/100/1000BASE-T SINGLE & DUAL-PORT TRANSFORMER MODULES

Military / Aerospace Grade



Electrical Schematic

1000B-5003/X

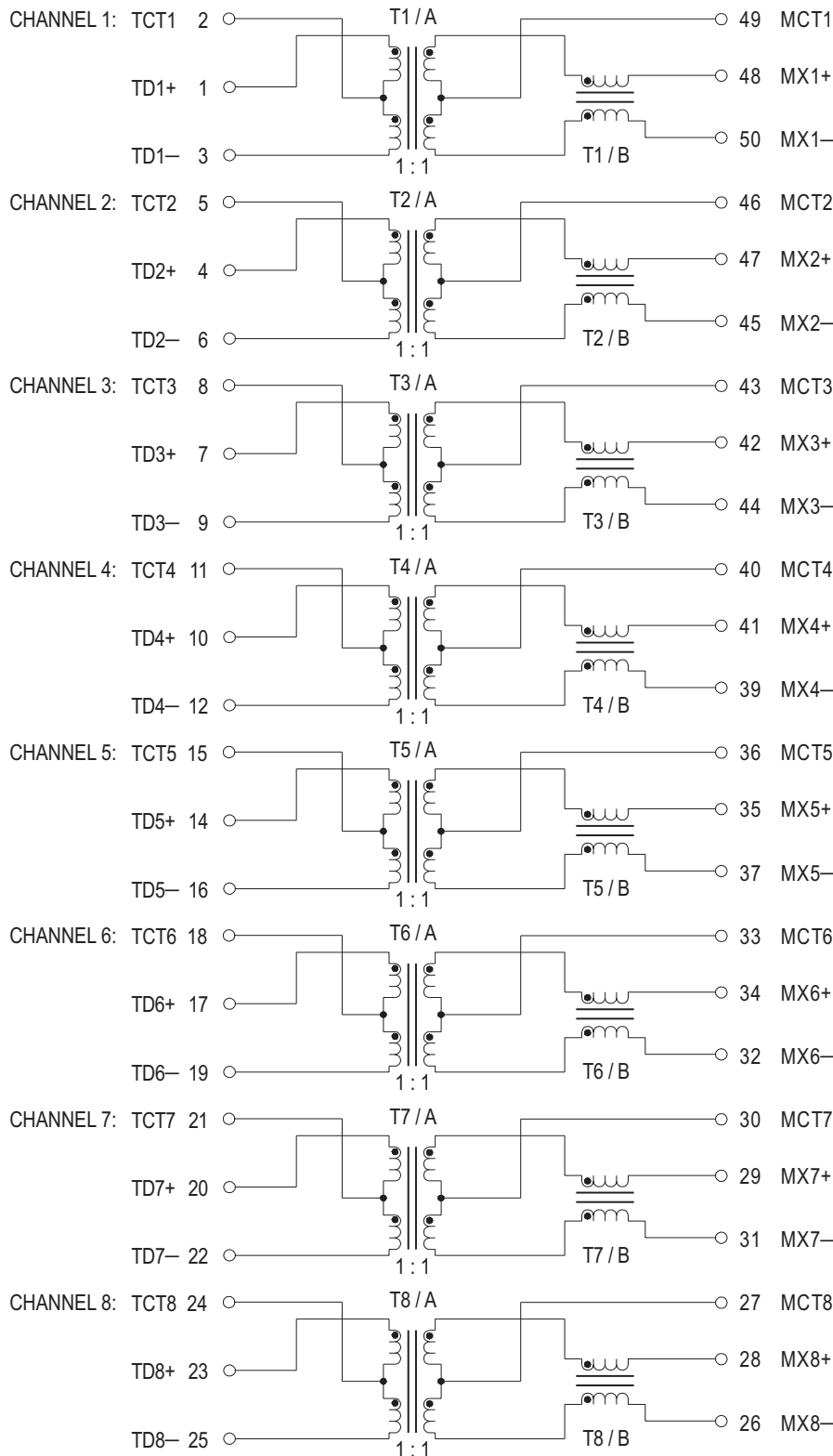

LEGEND

C I P
S I D E
T d
M x
M E D I A
S I D E

ALL CHANNELS ARE IN PHASE BETWEEN INPUT AND OUTPUT

10/100/1000BASE-T SINGLE & DUAL-PORT TRANSFORMER MODULES

Military / Aerospace Grade



Electrical Schematic

1000B-5002/X

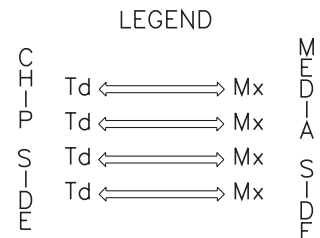
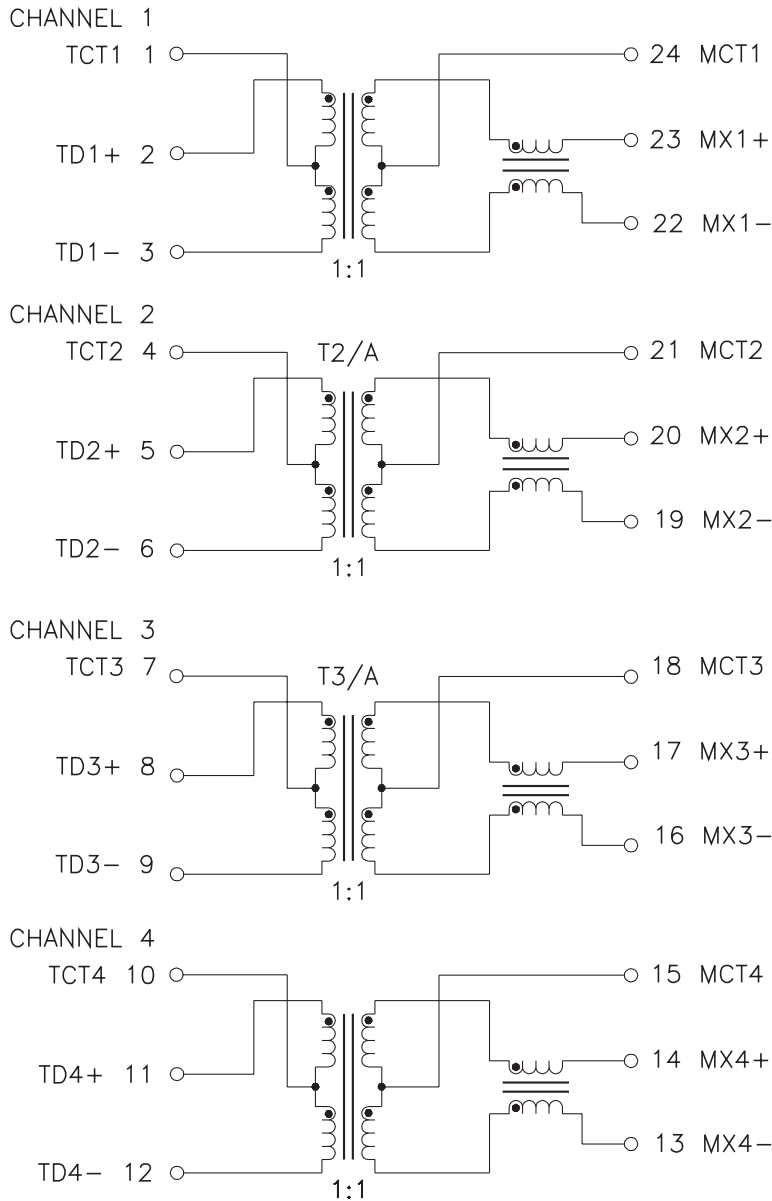

ALL CHANNELS ARE IN PHASE BETWEEN INPUT AND OUTPUT

For More Information:

Pulse Worldwide Headquarters
Two Pearl Buck Court
Bristol, PA 19007
U.S.A.

Pulse Europe
Zeppelinstrasse 15
D-71083 Herrenberg
Germany

Pulse China Headquarters
B402, Shenzhen Academy of
Aerospace Technology Bldg.
10th Kejinan Rd.
High-Tech Zone
Nanshan District
Shenzen, PR China 518057

Pulse North China
Room 2704/2705
Super Ocean Finance Ctr.
2067 Yan An Rd. West
Shanghai 200336
China

Pulse South Asia
135 Joo Seng Rd.
#03-02
PM Industrial Bldg.
Singapore 368363

Pulse North Asia
3F, No. 198
Zhongyuan Rd.
Zhongli City
Taoyuan County 320
Taiwan R. O. C.

www.pulseeng.com
Tel: 215 781 6400
Fax: 215 781 6403

Tel: 49 7032 7806 0
Fax: 49 7032 7806 135

Tel: 86 755 33966678
Fax: 86 755 33966700

Tel: 86 21 62787060
Fax: 86 2162786973

Tel: 65 6287 8998
Fax: 65 6287 8998

Tel: 886 3 4356768
Fax: 886 3 4356823 (Pulse)
Fax: 886 3 4356820 (FRE)

Performance warranty of products offered on this data sheet is limited to the parameters specified. Data is subject to change without notice. Other brand and product names mentioned herein may be trademarks or registered trademarks of their respective owners.

© Copyright, 2010. Pulse Engineering, Inc. All rights reserved.