

# 10/100/1000BASE-T SINGLE & DUAL-PORT TRANSFORMER MODULES

Military / Aerospace Grade



- Compliant with IEEE 802.ab for 1000Base-T
- 350µH OCL with 8mA bias at extended temperatures
- Operating and storage temperature:  
**1000B-5001/5002/5003: -40°C to +85°C**  
**1000B-5001X/5002X/5003X: -55°C to +125°C**
- IC grade transfer-molded package withstands 235°C peak temperature profile RoHS version withstands 245°C

## Electrical Specifications @ 25°C

Part Number <sup>1</sup>	Insertion Loss (dB MIN)	Return Loss (dB MAX)				Crosstalk (dB MAX)			CM to CM Rejection Ratio (dB MAX)			DM to CM Rejection Ratio (dB MAX)		
		0.1-100 MHz	30 MHz	60 MHz	80 MHz	100 MHz	30 MHz	60 MHz	100 MHz	30 MHz	60 MHz	100 MHz	30 MHz	60 MHz
1000B-5001	-1.20	-18	-12	-10	-10	-43	-37	-33	-40	-35	-30	-43	-37	-33
1000B-5001X	-1.40	-18	-12	-10	-8	-43	-37	-33	-40	-35	-30	-43	-37	-33
1000B-5002	-1.20	-18	-14	-12	-10	-43	-37	-33	-40	-35	-30	-43	-37	-33
1000B-5002X	-1.20	-18	-14	-12	-10	-43	-37	-33	-40	-35	-30	-43	-37	-33
1000B-5003	-1.20	-18	-14	-11	-9	-43	-37	-33	-40	-35	-30	-43	-37	-33
1000B-5003X	-1.20	-18	-14	-11	-9	-43	-37	-33	-40	-35	-30	-43	-37	-33

Note: 1. Add suffix NL for RoHS compliant part; i.e. 1000B-5001 becomes 1000B-5001NL.

## Mechanical

### 1000B-5001/X

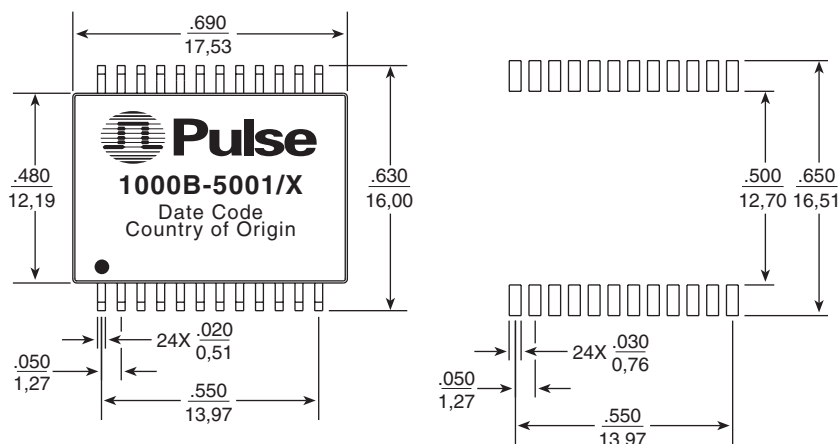

Weight ..... 3.0 grams  
 Tape and Reel ..... 300/reel  
 Tube ..... .25/tube

Dimensions: Inches  
 mm  
 Unless otherwise specified,  
 all tolerances are ± .010  
 0,25

### SUGGESTED PAD LAYOUT

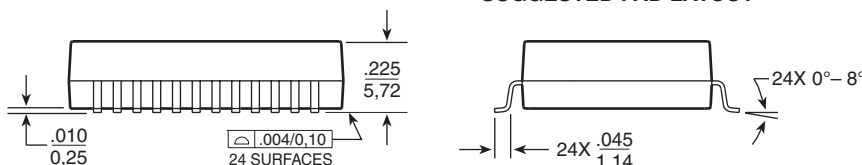

# 10/100/1000BASE-T SINGLE & DUAL-PORT TRANSFORMER MODULES

Military / Aerospace Grade



## Mechanicals

### 1000B-5002/X

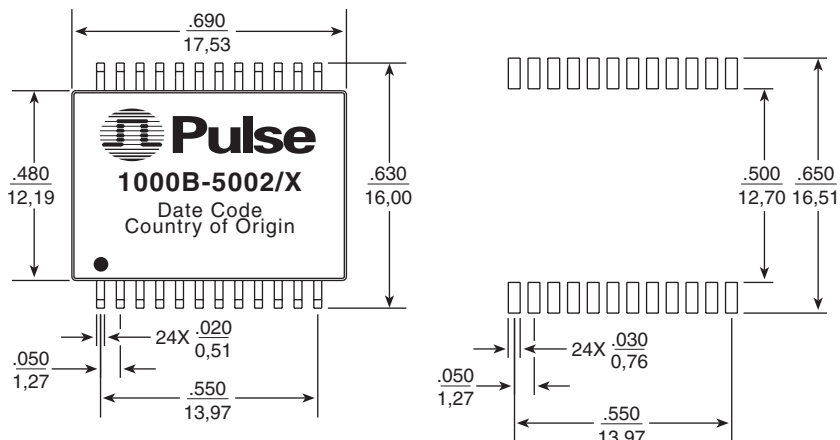

Weight .....2.6 grams  
Tape and Reel ..... 300/reel  
Tube ..... .25/tube

Dimensions:  $\frac{\text{Inches}}{\text{mm}}$   
Unless otherwise specified,  
all tolerances are  $\pm \frac{.010}{0,25}$

#### SUGGESTED PAD LAYOUT

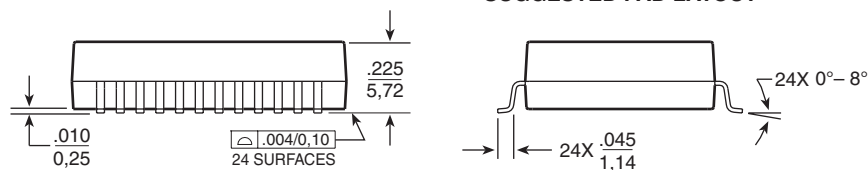

### 1000B-5003/X

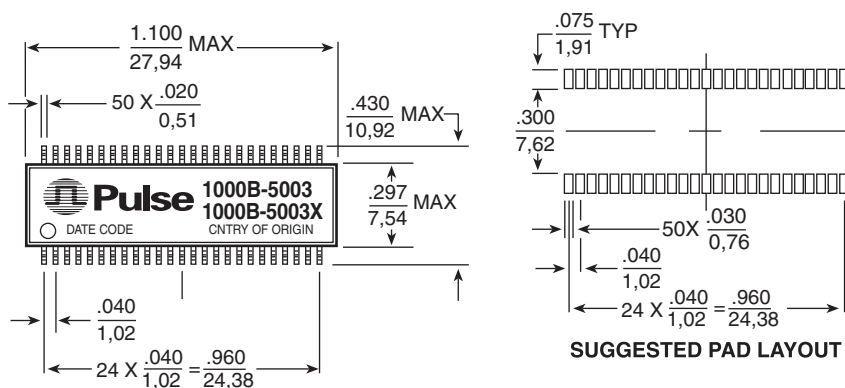

Weight .....3.5 grams  
Tape and Reel ..... 250/reel  
Tube ..... .15/tube

Dimensions:  $\frac{\text{Inches}}{\text{mm}}$   
Unless otherwise specified,  
all tolerances are  $\pm \frac{.010}{0,25}$

#### SUGGESTED PAD LAYOUT

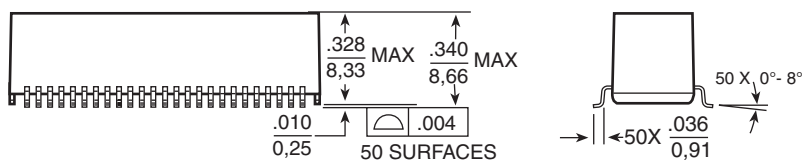

# 10/100/1000BASE-T SINGLE & DUAL-PORT TRANSFORMER MODULES

Military / Aerospace Grade



## Electrical Schematic

**1000B-5001/X**

CHANNEL 1

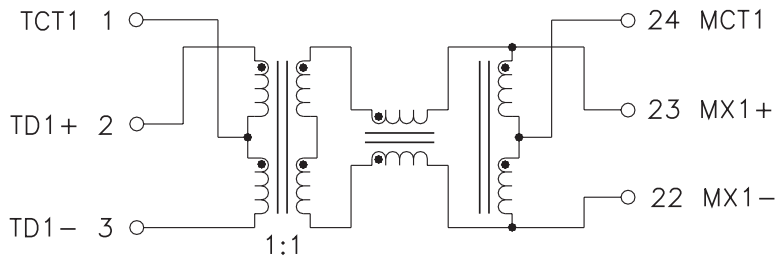

CHANNEL 2

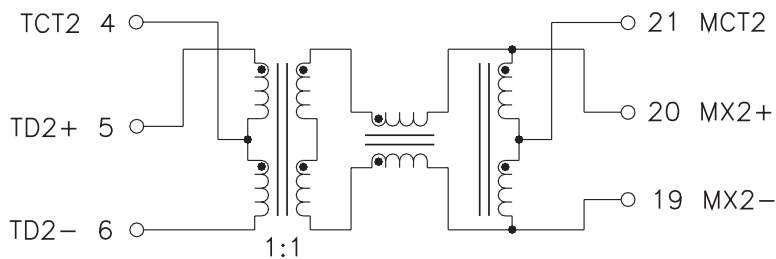

CHANNEL 3

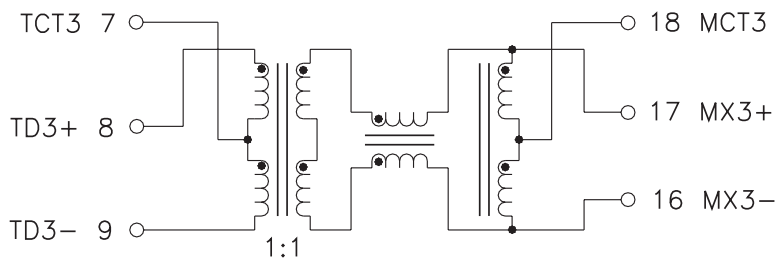

CHANNEL 4

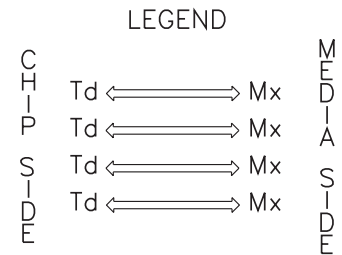
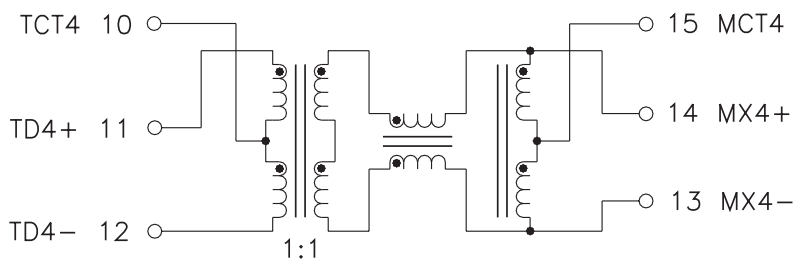

ALL CHANNELS ARE IN PHASE BETWEEN INPUT AND OUTPUT

# 10/100/1000BASE-T SINGLE & DUAL-PORT TRANSFORMER MODULES

Military / Aerospace Grade



## Electrical Schematic

**1000B-5003/X**

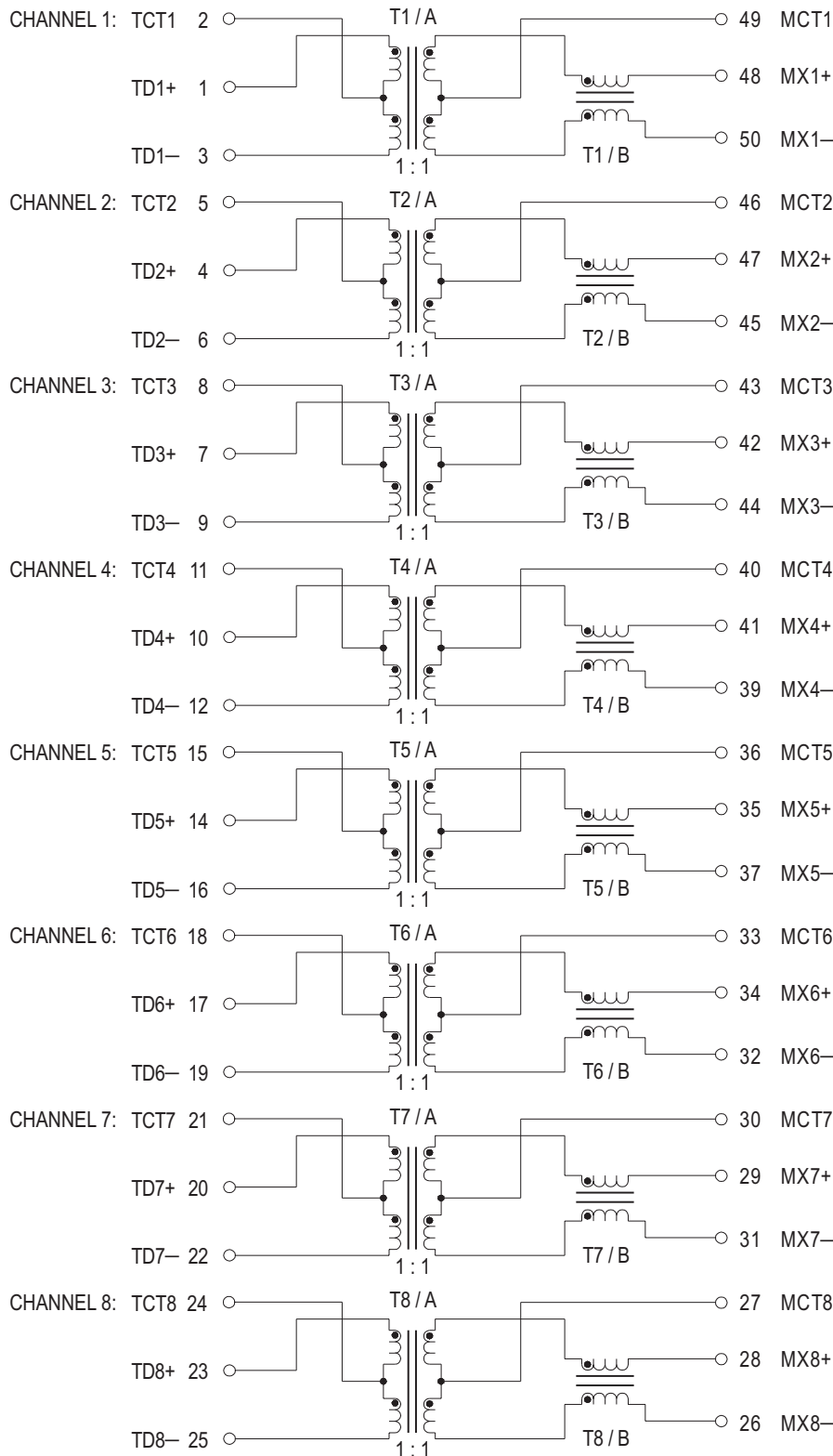

LEGEND

C I P
S I D E
T d

M x
M E D I A
S I D E

ALL CHANNELS ARE IN PHASE BETWEEN INPUT AND OUTPUT

# 10/100/1000BASE-T SINGLE & DUAL-PORT TRANSFORMER MODULES

## Military / Aerospace Grade



### Electrical Schematic

**1000B-5002/X**

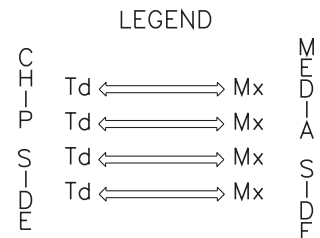
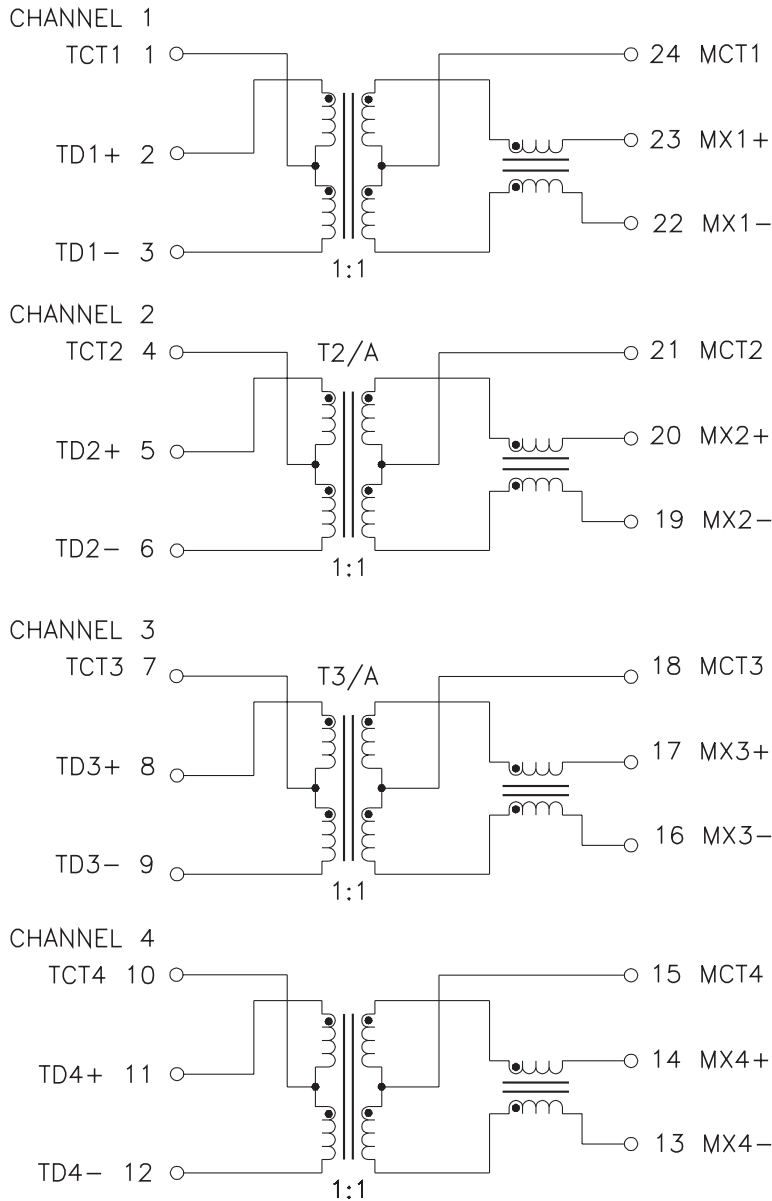

ALL CHANNELS ARE IN PHASE BETWEEN INPUT AND OUTPUT

### For More Information:

<p><b>Pulse Worldwide Headquarters</b> Two Pearl Buck Court Bristol, PA 19007 U.S.A.</p> <p><a href="http://www.pulseeng.com">www.pulseeng.com</a> Tel: 215 781 6400 Fax: 215 781 6403</p>	<p><b>Pulse Europe</b> Zeppelinstrasse 15 D-71083 Herrenberg Germany</p> <p>Tel: 49 7032 7806 0 Fax: 49 7032 7806 135</p>	<p><b>Pulse China Headquarters</b> B402, Shenzhen Academy of Aerospace Technology Bldg. 10th Kejinan Rd. High-Tech Zone Nanshan District Shenzen, PR China 518057</p> <p>Tel: 86 755 33966678 Fax: 86 755 33966700</p>	<p><b>Pulse North China</b> Room 2704/2705 Super Ocean Finance Ctr. 2067 Yan An Rd. West Shanghai 200336 China</p> <p>Tel: 86 21 62787060 Fax: 86 2162786973</p>	<p><b>Pulse South Asia</b> 135 Joo Seng Rd. #03-02 PM Industrial Bldg. Singapore 368363</p> <p>Tel: 65 6287 8998 Fax: 65 6287 8998</p>	<p><b>Pulse North Asia</b> 3F, No. 198 Zhongyuan Rd. Zhongli City Taoyuan County 320 Taiwan R. O. C.</p> <p>Tel: 886 3 4356768 Fax: 886 3 4356823 (Pulse) Fax: 886 3 4356820 (FRE)</p>
--	---	--	--	--	--

Performance warranty of products offered on this data sheet is limited to the parameters specified. Data is subject to change without notice. Other brand and product names mentioned herein may be trademarks or registered trademarks of their respective owners.

© Copyright, 2010. Pulse Engineering, Inc. All rights reserved.