

RF TRANSFORMER

For Wideband RF Applications



- RoHS peak reflow temperature rating: 245°C
- For single-ended to balanced applications
- Value-oriented construction
- Small surface mount package
- Excellent insertion loss
- Various impedance ratios available

Electrical Specifications @ 25°C — Operating Temperature -40°C to +85°C

Part Number ⁴	Impedance Ratio ¹ Pri:Sec (±2%)	Turns Ratio ¹ Pri:Sec (±2%)	Bandwidth ^{2,3} (MHz TYP)	Insertion Loss @ Midband (dB)	Schematic
CX2078NL	1:1	1:1	5-500	0.6	A
CX2081NL	1:1.5CT	1:1.2CT	5-125	0.9	B
CX2156NL	1:1	1:1	2.3 - 2700	0.2	A

1. **Impedance** and turns ratios are specified primary:secondary. (CT=Center Tap).
2. **Bandwidth** is referenced to midband loss.
3. **These transformers** are verified to operate from -40°C to +85°C. Contact Applications Engineering for performance data.
4. **Optional Tape & Reel** packaging can be ordered by adding a "T" suffix to the part number (ex: CX2078NLT).

Mechanical

Schematic

CX2078NL, CX2081NL, CX2156NL

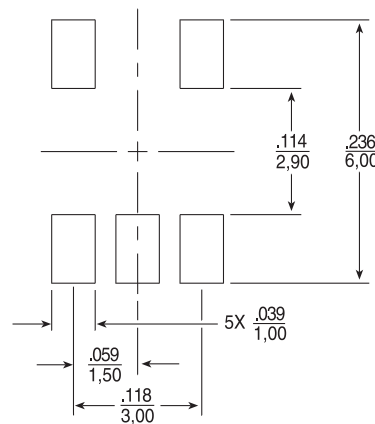
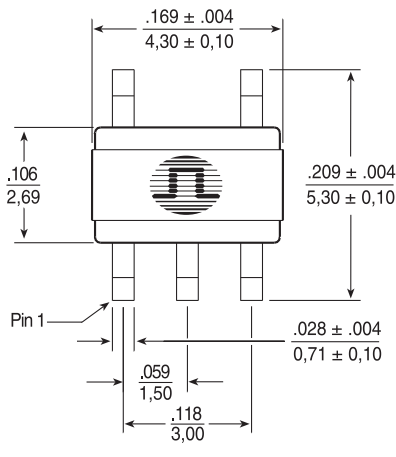

SUGGESTED PAD LAYOUT

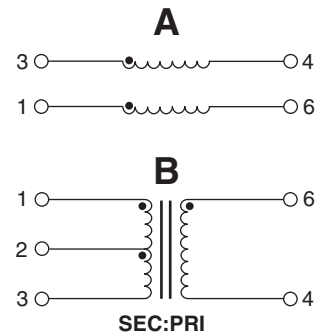
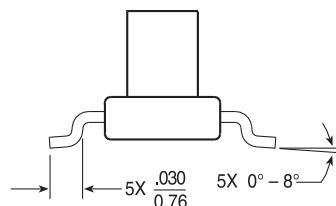
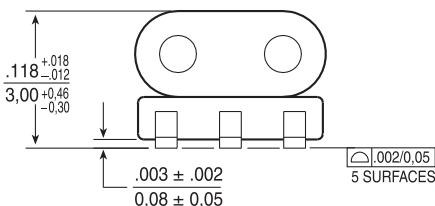

Weight 0.43 grams
 Tape & Reel 2200 /reel
 Tray 100 /tray

Dimensions: $\frac{\text{Inches}}{\text{mm}}$
 Unless otherwise specified,
 all tolerances are $\pm \frac{.010}{0.25}$

RF TRANSFORMER

For Wideband RF Applications



Application Notes

- A. Bandwidth specifications are typical in a 75 Ω system.
- B. Materials used in the products are UL94-V0 recognized. Products meet requirements of IEC 695-2-2 (Needle Flame Test).
- C. For additional impedance ratios and frequency ranges, please contact Applications Engineering.

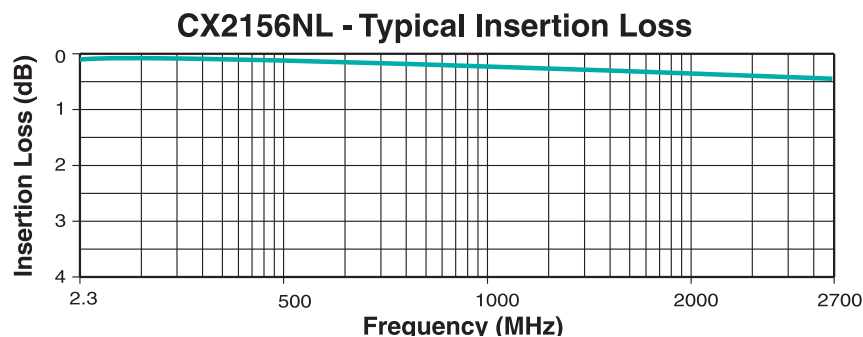
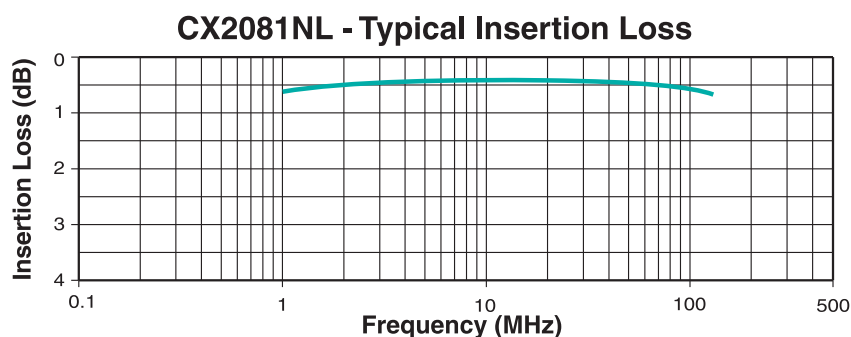
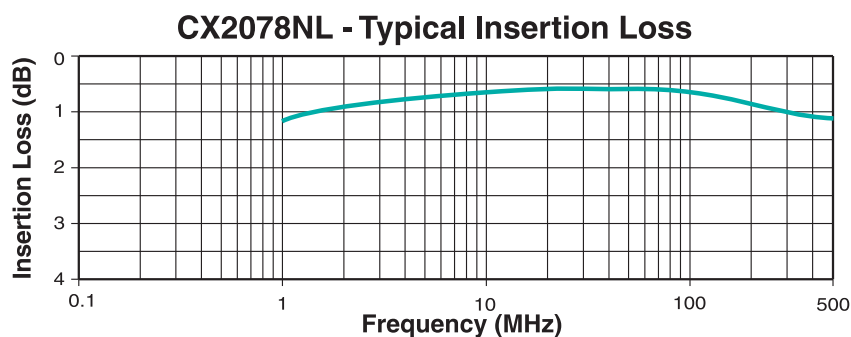

For More Information:

Pulse Worldwide Headquarters
12220 World Trade Dr.
San Diego, CA 92128
U.S.A.

Pulse Europe
Einsteinstrasse 1
D-71083 Herrenberg
Germany

Pulse China Headquarters
B402, Shenzhen Academy of
Aerospace Technology Bldg.
10th Kejinan Rd.
Hwigh-Tech Zone
Nanshan District
Shenzen, PR China 518057

Pulse North China
Room 2704/2705
Super Ocean Finance Ctr.
2067 Yan An Rd. West
Shanghai 200336
China

Pulse South Asia
135 Joo Seng Rd.
#03-02
PM Industrial Bldg.
Singapore 368363

Pulse North Asia
No. 26, Kao Ching Rd.
Yang Mei Chen
Taoyuan Hsien
Taiwan
R. O. C.

www.pulseeng.com
Tel: 858 674 8100
Fax: 858 674 8262

Tel: 49 7032 7806 0
Fax: 49 7032 7806 135

TEL: 86 755 33966678
FAX: 86 755 33966700

Tel: 86 21 62787060
Fax: 86 2162786973

TEL: 65 6287 8998
FAX: 65 6280 0080

Tel: 886 3 4643715
Fax: 886 3 4641911

Performance warranty of products offered on this data sheet is limited to the parameters specified. Data is subject to change without notice. Other brand and product names mentioned herein may be trademarks or registered trademarks of their respective owners.

© Copyright, 2009. Pulse Engineering, Inc. All rights reserved.

www.pulseeng.com