





# RF TRANSFORMERS/BALUNS

## Transformers for Wideband RF Applications



-  Frequency Band: 700-2150MHz
-  Optimized for satellite TV applications
-  Miniature surface mount package
-  Various impedance ratios available
-  Ideal for Balanced-to-Unbalanced applications

### Electrical Specifications @ 25°C — Operating Temperature -40°C to +85°C

Part Number	Impedance Ratio <sup>1</sup> Pri:Sec (±2%)	Insertion Loss @ 700-2150MHz (dB TYP/MAX)	Return Loss (dB MIN)	Primary Pins
CX2076	1:1	0.6/1.5	9.0	4-6

NOTE: Optional Tape & Reel packaging can be ordered by adding a "T" suffix to the part number (ex: CX2076T).

### Mechanical

### Schematics

#### RAQ

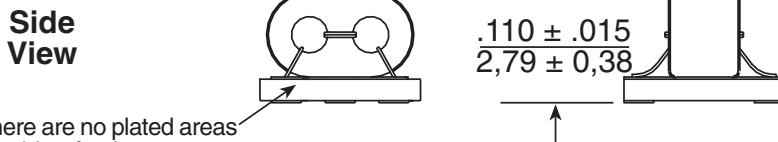
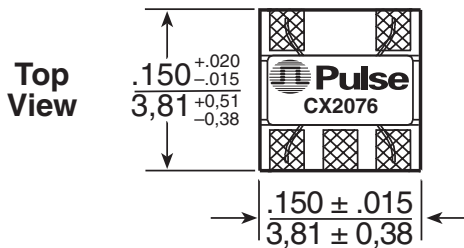

There are no plated areas on side of substrate.

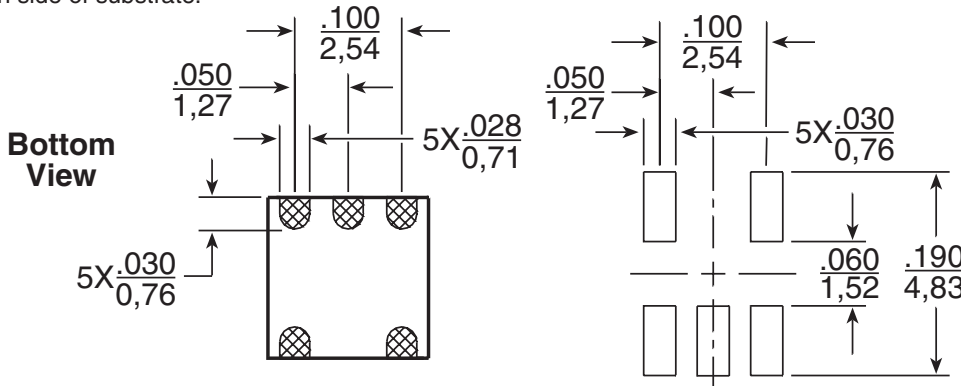

Tape & Reel .....1000 /reel  
 Tray .....100 /tray  
 Power Rating .....30 mA MAX; 0.25 W MAX

Dimensions: Inches  
 mm  
 Unless otherwise specified,  
 all tolerances are ± .010  
 0,25

### SUGGESTED PAD LAYOUT

# RF TRANSFORMERS/BALUNS

## Transformers for Wideband RF Applications



### Application Notes

- A. Materials used in the products are UL94-V0 recognized. Products meet requirements of IEC 695-2-2 (Needle Flame Test).
- B. For additional impedance ratios and frequency ranges, please contact Applications Engineering.

### Notes from Tables

1. Impedance and turns ratios are specified primary:secondary.
2. These transformers are verified to operate from -40°C to +85°C. Contact Pulse Applications Engineering for performance data.

### Tape and Reel Information

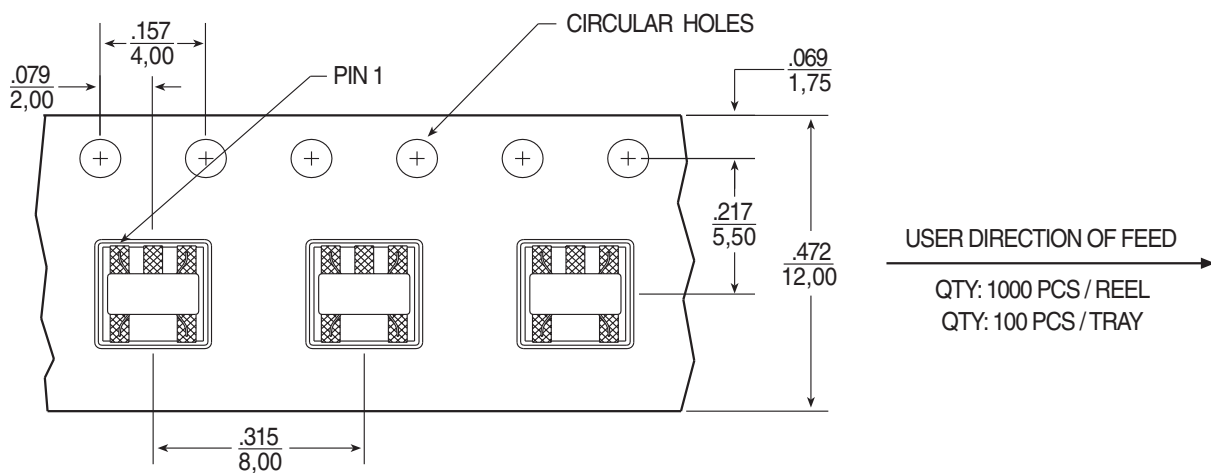

### For More Information :

UNITED STATES (Worldwide)	UNITED KINGDOM (Northern Europe)	FRANCE (Southern Europe)	SINGAPORE (Southern Asia)	TAIWAN, R.O.C. (Northern Asia)	HONG KONG (China/Hong Kong)	DISTRIBUTOR
12220 World Trade Drive San Diego, CA 92128 U.S.A. http://www.pulseeng.com TEL: 858 674 8100 FAX: 858 674 8262	1 & 2 Huxley Road The Surrey Research Park Guildford, Surrey GU2 5RE United Kingdom TEL: 44 1483 401700 FAX: 44 1483 401701	Zone Industrielle F-39270 Orgelet France TEL: 33 3 84 35 04 04 FAX: 33 3 84 25 46 41	150 Kampong Ampat #07-01/02 KA Centre Singapore 368324 TEL: 65 6287 8998 FAX: 65 6280 0080	3F-4, No. 81, Sec. 1 HsinTai Wu Road Hsi-Chih, Taipei Hsien Taiwan, R.O.C. Tel: 886 2 2698 0228 FAX: 886 2 2698 0948	9/F, Phase 2, Tai Sang Shatin Warehouse Centre 6 Wong Chuk Yeung Street Fotan, Shatin, Hong Kong TEL: 852 2788 6588 FAX: 852 2776 1055	

Performance warranty of products offered on this data sheet is limited to the parameters specified. Data is subject to change without notice. Other brand and product names mentioned herein may be products and/or registered trademarks of their respective owners.