

FCI CONFIDENTIAL

FCI

This document is the property of and includes CONFIDENTIAL and PROPRIETARY information of FCI. No part of the information herein may be used in any way or disclosed to other parties without the written consent of FCI. Copyright FCI.

PRODUCT NO.
61126-****/****LF

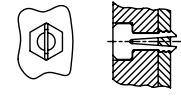
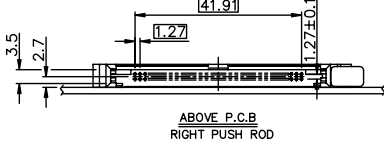
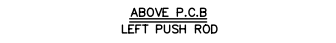
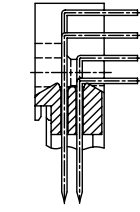
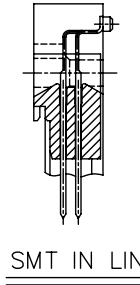
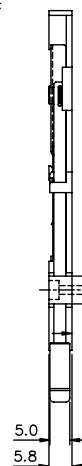
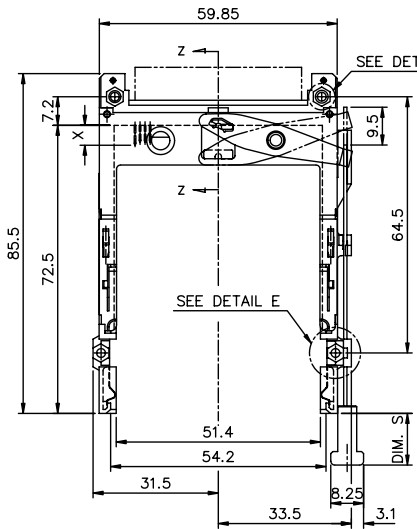
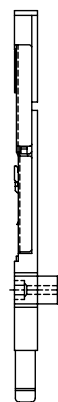
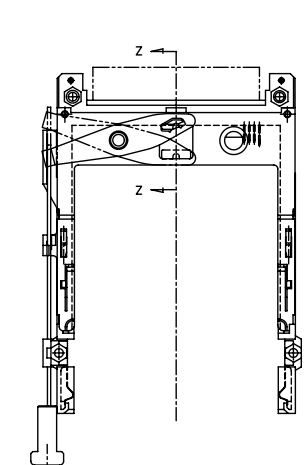

DETAIL E
FOR 61126-****H/****HLF ONLY

<SEC. Z-Z>

mat'l. code		surface	tolerance	projection	product family
ISO 1302		ISO 406	ISO 101		
ltr	ecn no	dr	date	tolerances unless otherwise specified	title
F	V11056	W L	03/20/01	angles	NARROW BODY EJ HEADER ASS'Y 68POS.
F	V12191	W L	09/20/01	linear ±0.30	
G	T10287	W L	10/19/01	±2°	
				scale 1:1	
H	N05-0063	WB	03/04/05	dr WENDY CHEN	07/12/95
J	N08-0029	MZ	02/26/08	enr L.W. LU	07/12/95
				chr JOSEPH HSIA	07/12/95
				appd JENN TSAO	07/12/95
sheet index	revision sheet	J	J	J	J
1	2	3	4		
type		CUSTOMER		Drawing	
dwg no		61126		sheet 1 of 4 size A4	

PDM: Rev:J STATUS Released Printed: Oct 12, 2010 6

form: A3

FCI CONFIDENTIAL

FCI

This document is the property of and includes CONFIDENTIAL and PROPRIETARY information of FCI. No part of the information herein may be reproduced, stored in a retrieval system, or transmitted in any form or by any means, electronic, mechanical, photocopying, recording, or otherwise, without the prior written consent of FCI. Copyright FCI.

PRODUCT NO.
61126-****

LEFT	BELOW	SMT-IL	NONE	61126-602XY	94898-502	95079-00XY	NONE	LAYOUT 2
RIGHT	BELOW	SMT-IL	NONE	61126-502XY	94898-502	95079-10XY	NONE	LAYOUT 1
LEFT	ABOVE	SMT-IL	NONE	61126-102XY	94898-002	95079-10XY	NONE	LAYOUT 1
RIGHT	ABOVE	SMT-IL	NONE	61126-002XY	94898-002	95079-00XY	93925-001	LAYOUT 4
RIGHT	ABOVE	SMT-IL	NONE	61126-002XYH ④	94898-002	95079-00XY	NONE	LAYOUT 3
LEFT	BELOW	R/A	5	61126-650XY	94898-520	95079-05XY	NONE	LAYOUT 4
RIGHT	BELOW	R/A	5	61126-550XY	94898-520	95079-15XY	NONE	LAYOUT 3
LEFT	ABOVE	R/A	5	61126-150XY	94898-020	95079-15XY	93925-004	LAYOUT 4
LEFT	ABOVE	R/A	5	61126-150XYH ④	94898-020	95079-15XY	93925-004	LAYOUT 3
RIGHT	ABOVE	R/A	5	61126-050XYH ④	94898-020	95079-05XY	93925-004	LAYOUT 4
RIGHT	ABOVE	R/A	5	61126-050XY	94898-020	95079-05XY	NONE	LAYOUT 3
LEFT	BELOW	R/A	4	61126-640XY	94898-510	95079-04XY	NONE	LAYOUT 4
RIGHT	BELOW	R/A	4	61126-540XY	94898-510	95079-14XY	NONE	LAYOUT 3
LEFT	ABOVE	R/A	4	61126-140XY	94898-010	95079-14XY	NONE	LAYOUT 4
RIGHT	ABOVE	R/A	4	61126-040XY	94898-010	95079-04XY	NONE	LAYOUT 3
LEFT	BELOW	R/A	2	61126-620XY	94898-540	95079-02XY	NONE	LAYOUT 4
RIGHT	BELOW	R/A	2	61126-520XY	94898-540	95079-12XY	NONE	LAYOUT 3
LEFT	ABOVE	R/A	2	61126-120XY	94898-040	95079-12XY	NONE	LAYOUT 4
RIGHT	ABOVE	R/A	2	61126-020XY	94898-040	95079-02XY	NONE	LAYOUT 3
LEFT	BELOW	R/A	NONE	61126-600XY	94898-500	95079-00XY	NONE	LAYOUT 4
RIGHT	BELOW	R/A	NONE	61126-500XY	94898-500	95079-10XY	NONE	LAYOUT 3
LEFT	ABOVE	R/A	NONE	61126-100XY	94898-000	95079-10XY	NONE	LAYOUT 4
LEFT	ABOVE	R/A	NONE	61126-100XYH ④	94898-000	95079-10XY	93925-001	LAYOUT 3
RIGHT	ABOVE	R/A	NONE	61126-000XYH ④	94898-000	95079-00XY	93925-001	LAYOUT 4
RIGHT	ABOVE	R/A	NONE	61126-000XY	94898-000	95079-00XY	NONE	LAYOUT 3
① PUSH ROD LOCATION	② PCB SIDE	SOLDER TAIL	DIM. L STAND-OFF	TO MAKE FINAL ASS'Y PART NUMBER	HEADER PART NUMBER	MECHANISM ASS'Y P/N	HOLD-DOWN (4 PCS)	PCB LAYOUT SEE PAGE 3

NOTE : (CONTINUOUS ON SHEET 3)

- ① PUSH ROD LOCATION AND PCB SIDE ARE AS APPEARS INSTALLED.
- ② SOLDER TAIL KEY:
R/A = RIGHT ANGLE PIN-THROUGH-HOLE
SMT-IL = SURFACE MOUNT IN-LINE(SINGLE ROW)
- 3. X = PUSH ROD LENGTH FROM END OF GUIDERAIL

DIM. S C : 13.0 mm
 D : 15.6 mm
 F : 21.0 mm

Y = PUSH ROD COLOR
A : BLACK
H : NATURAL

- ④ INCLUDES 4 HOLD DOWNS.

- ⑤ "M" SHOW IT IS LOW COST VERSION, IT IS OPTIONAL, SUCH AS 61126-100MCAHLF IS LOW COST VERSION 61126-100CAHLF IS NOT LOW COST VERSION

mat'l. code		surface ISO 1302	tolerance ISO 406 ISO 101	projection 101	product family
ltr	ecn no	dr	date	tolerances unless otherwise specified	title
J				angles linear ±0.30	NARROW BODY EJ HEADER ASS'Y 68POS.
				±2'	
				scale 1:1	
		dr	WENDY CHEN	07/12/95	dwg no
		engr	L.W. LU	07/12/95	61126
		chr	JOSEPH HSIA	07/12/95	sheet 2 of 4
		pppd	JENN TSAO	07/12/95	A4
sheet index	revision sheet				type CUSTOMER Drawing

PDM: Rev:J STATUS Released Printed: Oct 12, 2010 6

form: A3

FCI CONFIDENTIAL

FCI

This document is the property of and contains CONFIDENTIAL and PROPRIETARY information of FCI. No part of the information shown on this document may be used in any way or disclosed to others without the written consent of FCI. Copyright © FCI.

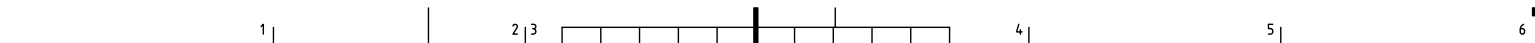

PRODUCT NO.
61126-****LF

LEFT	BELOW	SMT-IL	NONE	61126-602XYLF	94898-502LF	95079-00XY	NONE	LAYOUT 2
RIGHT	BELOW	SMT-IL	NONE	61126-502XYLF	94898-502LF	95079-10XY	NONE	LAYOUT 1
LEFT	ABOVE	SMT-IL	NONE	61126-102XYLF	94898-002LF	95079-10XY	NONE	LAYOUT 4
RIGHT	ABOVE	SMT-IL	NONE	61126-002XYLF	94898-002LF	95079-00XY	93925-001	LAYOUT 3
RIGHT	ABOVE	SMT-IL	NONE	61126-002XYHLF④	94898-002LF	95079-00XY	93925-004	LAYOUT 3
LEFT	BELOW	R/A	5	61126-650XYLF	94898-520LF	95079-05XY	NONE	LAYOUT 4
RIGHT	BELOW	R/A	5	61126-550XYLF	94898-520LF	95079-15XY	NONE	LAYOUT 3
LEFT	ABOVE	R/A	5	61126-150XYLF	94898-020LF	95079-15XY	NONE	LAYOUT 4
LEFT	ABOVE	R/A	5	61126-150XYHLF④	94898-020LF	95079-15XY	93925-004	LAYOUT 3
RIGHT	ABOVE	R/A	7.7	61126-070XYLF ⚠	94898-077MLF	95079-07XY	NONE	LAYOUT 3
RIGHT	ABOVE	R/A	5	61126-050XYHLF④	94898-020MLF	95079-05XY	93925-004	LAYOUT 3
RIGHT	ABOVE	R/A	5	61126-050XYLF	94898-020LF	95079-05XY	NONE	LAYOUT 4
LEFT	BELOW	R/A	4	61126-640XYLF	94898-510LF	95079-04XY	NONE	LAYOUT 3
RIGHT	BELOW	R/A	4	61126-540XYLF	94898-510LF	95079-14XY	NONE	LAYOUT 4
LEFT	ABOVE	R/A	4	61126-140XYLF	94898-010LF	95079-14XY	NONE	LAYOUT 3
RIGHT	ABOVE	R/A	4	61126-040XYLF	94898-010LF	95079-04XY	NONE	LAYOUT 4
LEFT	BELOW	R/A	2	61126-620XYLF	94898-540LF	95079-02XY	NONE	LAYOUT 3
RIGHT	BELOW	R/A	2	61126-520XYLF	94898-540LF	95079-12XY	NONE	LAYOUT 4
LEFT	ABOVE	R/A	2	61126-120XYLF	94898-040LF	95079-12XY	NONE	LAYOUT 3
RIGHT	ABOVE	R/A	2	61126-020XYLF	94898-040LF	95079-02XY	NONE	LAYOUT 4
LEFT	BELOW	R/A	NONE	61126-600XYLF	94898-500LF	95079-00XY	NONE	LAYOUT 3
RIGHT	BELOW	R/A	NONE	61126-500XYLF	94898-500LF	95079-10XY	NONE	LAYOUT 4
LEFT	ABOVE	R/A	NONE	61126-100XYLF	94898-000LF	95079-10XY	NONE	LAYOUT 3
LEFT	ABOVE	R/A	NONE	61126-100XYHLF④	94898-000LF	95079-10XY	93925-001	LAYOUT 4
RIGHT	ABOVE	R/A	NONE	61126-000XYHLF④	94898-000LF	95079-00XY	93925-001	LAYOUT 3
RIGHT	ABOVE	R/A	NONE	61126-000XYLF	94898-000LF	95079-00XY	NONE	LAYOUT 4
① PUSH ROD LOCATION	② PCB SIDE	SOLDER TAIL	DIM. L STAND-OFF	TO MAKE FINAL ASS'Y PART NUMBER	HEADER PART NUMBER	MECHANISM ASS'Y P/N	HOLD-DOWN (4 PCS)	PCB LAYOUT SEE PAGE 3

NOTE: (CONTIONOUS FROM SHEET 2)

- 6. IF LEAD FREE P/N. THE HOUSING WILL WITHSTAND EXPOSURE TO 260°C PEAK TEMPERATURE
SOLDER TAIL : SMT-IL, SMT-STG CAN RESIST 40 SECONDS IN A CONVECTION, INFRA-RED OR VAPOR PHASE REFLOW OVEN.
SOLDER TAIL : R/A CAN RESIST 10 SECONDS IN A WAVE SOLDER APPLICATION WITH A 1.00MM MINIMUM THICK CIRCUIT BOARD.
- 7. IF LEAD FREE P/N.THE PRODUCT MEETS EUROPEAN UNION DIRECTIVES AND OTHER COUNTRY REGULATIONS AS DISCRIBLED IN GS-22-008
- 8. LEAD FREE P/N PACKAGING MEETS GS-14-920 SPECIFICATION

mat'l. code				surface	tolerance	projection	product family
ltr				ISO 1302	ISO 406 ISO 101	101	
ecn no				tolerances unless otherwise specified			title
dr				angles	linear	±0.30	NARROW BODY
date				±2'	linear	MM	EJ HEADER ASS'Y 68POS.
				scale 1:1			
				dr	WENDY CHEN	07/12/95	dwg no
				enfr	L.W. LU	07/12/95	sheet 3 of 4
				chr	JOSEPH HSIA	07/12/95	size
				appd	JENN TSAO	07/12/95	A4
				type CUSTOMER Drawing			
sheet index	revision sheet						

FCI CONFIDENTIAL

FCI

FLconnect.com

This document is the property of and includes CONFIDENTIAL and PROPRIETARY information of FCI. No part of the information shown on this document may be used in any way or disclosed to others without the written consent of FCI. Copyright FCI

PRODUCT NO.
61126-****/****LF

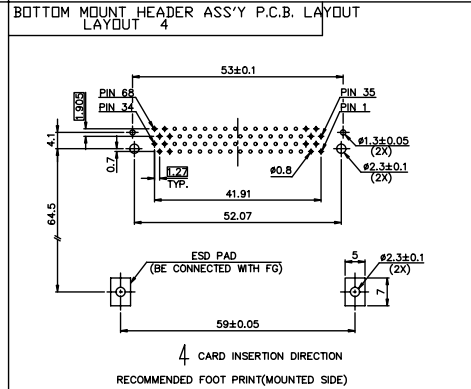
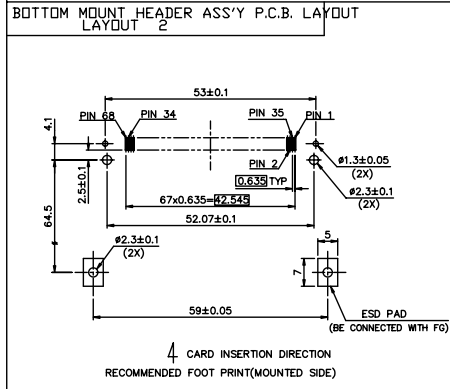
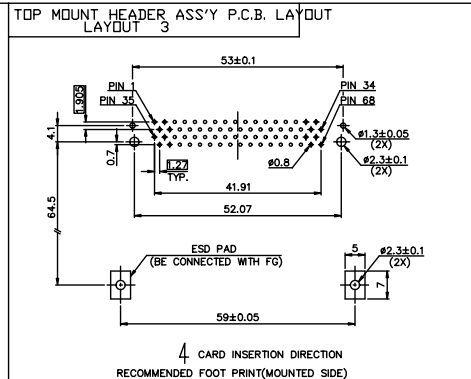
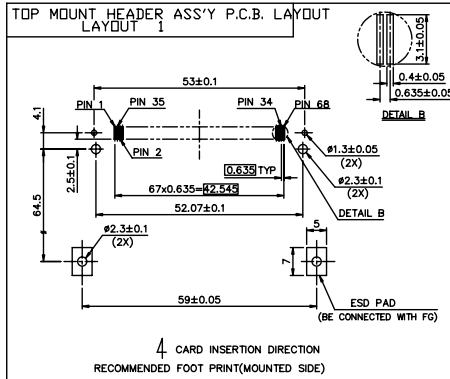

mat'l. code	surface	tolerance	projection	product family
	ISO 1302	ISO 406 ISO 101		
lfr	ecn	no	dr	date
J				
		angles	linear	±0.30
			±2'	scale 1:1
dr	WENDY CHEN	07/12/95	FCI	NARROW BODY EJ HEADER ASS'Y 68POS.
enfr	L.W. LU	07/12/95		
chr	JOSEPH HSIA	07/12/95		
appd	JENH TSAO	07/12/95		
sheet	revision	sheet	sheet 4 of 4	
index			size A4	
			type CUSTOMER Drawing	

PDM: Rev:J

STATUS Released

Printed: Oct 12, 2010 6