

MIL-STD-1553

Interface Transformers

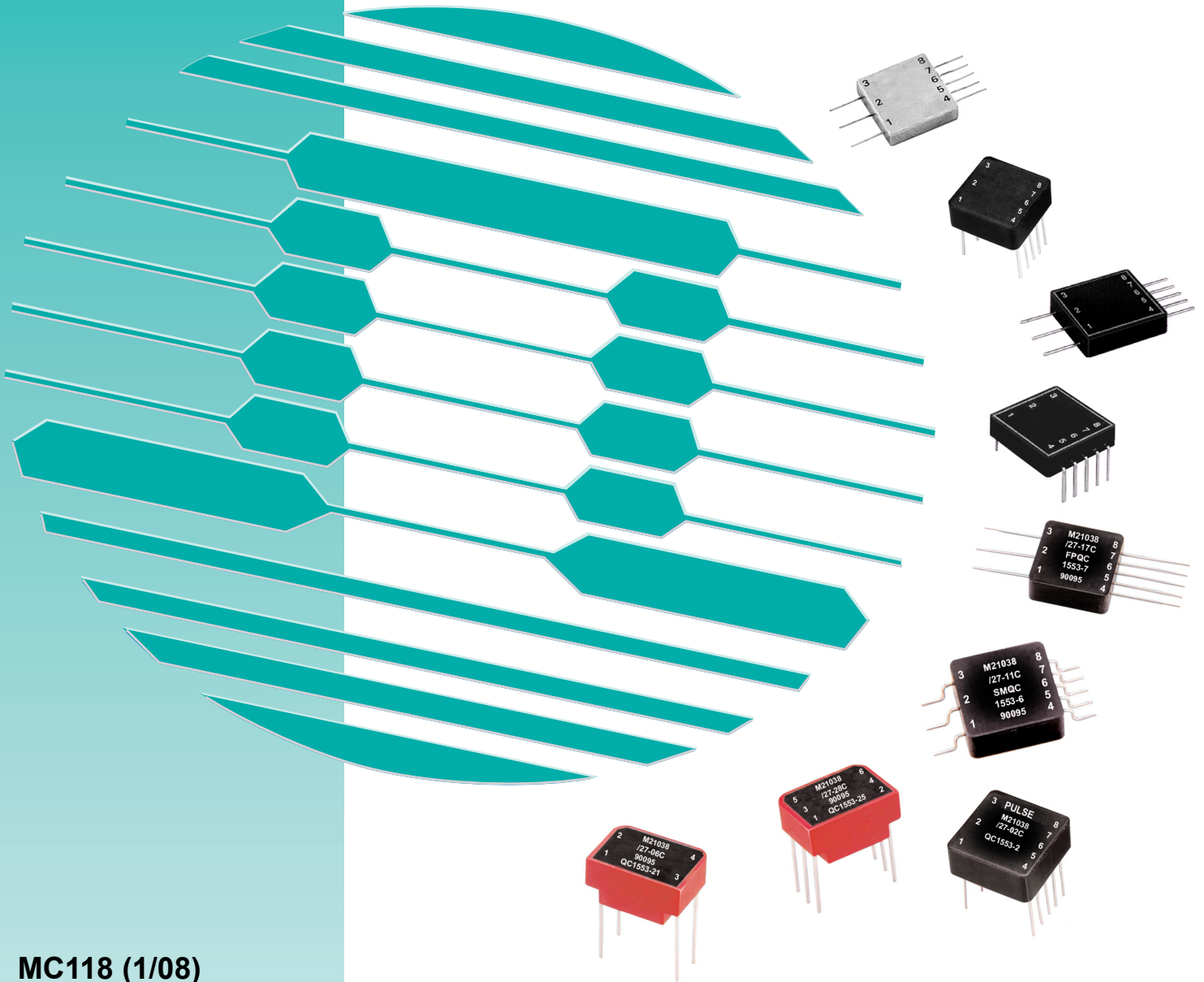

MC118 (1/08)

MIL-STD-1553 TRANSFORMERS



TABLE of CONTENTS

QPL MIL-STD-1553 Interface Transformers Overview	2-3
Single Ratio Transformers - Through Hole	4-5
Dual Ratio Transformers - Through Hole	6-7
Dual Ratio Transformers - Surface Mount	8-9
non-QPL MIL-STD-1553 Interface Transformers Overview	10-11
Dual Ratio Transformers - Single Interface, Through Hole, Low Profile	12
Dual Ratio Transformers - Single Interface, Surface Mount, Low Profile, Flat Pack and Gull Wing	13
Dual Ratio Transformers - Dual Interface, Through Hole, Low Profile	14
Dual Ratio Transformers - Dual Interface, Surface Mount, Low Profile, Flat Pack and Gull Wing	15
Dual Ratio Transformers - Dual Interface, Through Hole, Stacked	16
Dual Ratio Transformers - Dual Interface, Surface Mount, Stacked, Flat Pack and Gull Wing	17
Dual Ratio Transformers - Single Interface, Surface Mount, Hermetically-sealed, Flat Pack	18
Dual Ratio Transformers - Single Interface, Through Hole, Standard Profile Value Series (COTS)	19
Dual Ratio Transformers - Single Interface, Through Hole and Surface Mount, Stacked, Low Profile . . .	20-21
Warranty	22

MIL-STD-1553 TRANSFORMERS

QPL Interface Transformers Overview



QPL MIL-STD-1553 Interface Transformers

As “Technitrol Components Division,” we were the first to achieve QPL status for MIL-STD-1553B interface transformers, also known as low-power pulse transformers. Today, as “Pulse Military Aerospace Division,” our QPL transformer line includes a wide selection of products for each of the product levels called for by MIL-PRF-21038/27, formerly MIL-T-21038/27.

We also were the first to achieve QPL status on surface-mount MIL-STD-1553 pulse transformers -- more than 20 years ago. To this day, many manufacturers have

difficulty producing components that can survive the high-heat rigors of surface mounting and the performance, reliability, part-to-part repeatability, and lifespan required by high-rel military and commercial applications.

The first several pages of this catalog cover all of our QPL transformer products. Each part has a military designation number (found on DESC/DSCC approved drawings) as well as our own product number. These part numbers are listed in the specification tables.

MIL-PRF-21038E (8 July 1998) supersedes **MIL-T-21038D** (11 May 1979) and establishes three product levels for low power pulse transformers. The new specification allows designers to select a QPL device and limit the testing to what is needed for the application:

- **Level C** - for high reliability commercial/industrial applications;
- **Level M** - for general purpose military applications;
- **Level T** - for high reliability critical military applications.

Level C parts are tested to our internal specifications. Group A or B testing is not performed on **Level C** parts. **Level M** parts is exactly the same as the original QPL product that was defined by the earlier **MIL-T-21038/27** specification. **Level T** part receives the most extensive testing along with thermal cycling. For information about testing to selected levels, see next page.

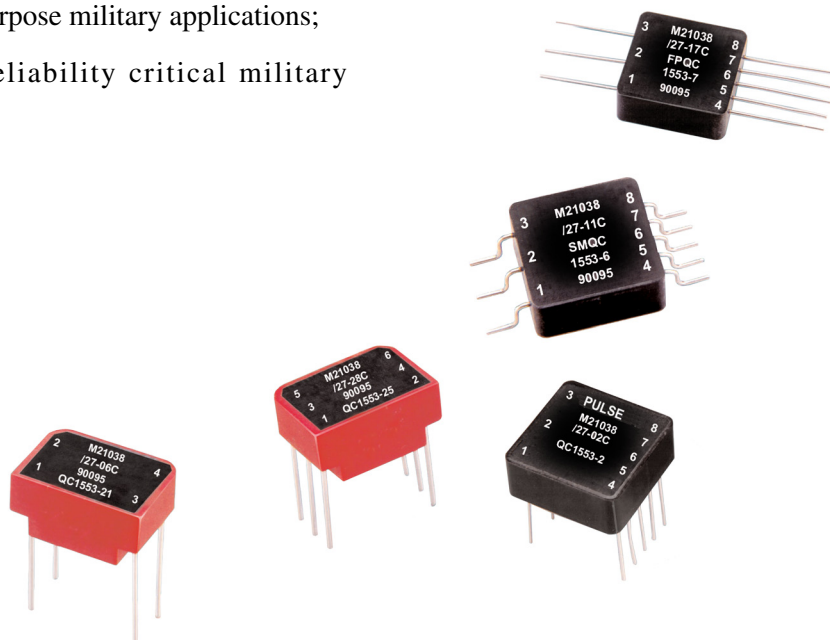

MIL-STD-1553 TRANSFORMERS

QPL Interface Transformers Overview



MIL-PRF-21038/27 Inspection, Sampling, Testing

Table 1 — Group A Inspection					
Level "C"***		Level "M"		Level "T"	
Tests	Sampling Plan	Tests	Sampling Plan	Tests	Sampling Plan
N/A	N/A	Electrical Characteristics per MIL-PRF-21038/27	Sample per Table 3	Thermal Shock	100%
N/A	N/A	Visual and Mechanical Inspection	Sample per Table 3	Winding Continuity	100%
N/A	N/A	N/A	N/A	Electrical Characteristics per MIL-PRF-21038/27	100%
N/A	N/A	N/A	N/A	Impedance	Sample per Table 3
N/A	N/A	N/A	N/A	Visual and Mechanical Inspection	Sample per Table 3

Table 2 — Group B Inspection					
Level "C"***		Level "M"		Level "T"	
Tests	Sampling Plan	Tests	Sampling Plan	Tests	Sampling Plan
N/A	N/A	Dielectric Withstanding Voltage	Sample per Table 3	Dielectric Withstanding Voltage	Sample per Table 3
N/A	N/A	Insulation Resistance	Sample per Table 3	Insulation Resistance	Sample per Table 3

Table 3 — Sampling Plans for Group A and Group B Inspections		
Lot Size	Group A, Group II Inspections	Group B
1 to 5	All	All
6 to 13	All	5
14 to 50	13	5
51 to 90	13	7
91 to 150	13	11
151 to 280	20	13
281 to 500	29	16
501 to 1200	34	19
1,201 to 3,200	42	23
3,201 to 10,000	50	29

****NOTE:** Parts ordered to Level C are certified to comply with MIL-PRF-21038 Level C, however testing is performed per manufacturer's internal requirements and sampling rates.

MIL-STD-1553 TRANSFORMERS

Single Ratio THT QPL Pulse Transformers

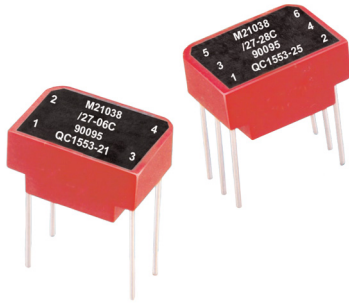

- ☑ Qualified for use in QPL MIL-STD-1553 applications
- ☑ Single ratio packages (see Schematics)
- ☑ Designed, built, and tested to MIL-PRF-21038 Levels* C, M, and T
- ☑ Package C is 4-lead; package D is 6-lead (center tap)
- ☑ Built in ISO 9001 facility
- ☑ Applicable specifications

- MIL-STD-1553B
- MIL-STD-202
- MIL-PRF-21038
- ISO 9001

- * ■ **Level C** - for high reliability commercial/industrial applications
- **Level M** - for general purpose military applications
- **Level T** - for high reliability critical military applications

Summary Performance Specifications	
Impedance	(see table below)
Drop	≤ 20%
Overshoot	±1V MAX
Common Mode Rejection (CMR)	≥ 45dB
Frequency Range (no load)	75kHz to 1MHz
Operating Temperature Range	-55°C to 130°C
Weight	≤ 5 grams
Insulation Resistance (MIN)	10K MΩ @ 250Vdc
Dielectric Withstanding Voltage	100Vrms

Characteristics									
Line	Level	Military Designation No.	Pulse Part No.	Package	Height (in. MAX)	Terminals	Ratio (±3%)	RDC (Ω MAX)	Impedance (Ω MIN)
1	C	M21038/27-05C	QC1553-20	C	.250	1-2:4-3	1:1.41	1-2 2.2 4-3 2.7	(4-3) 3,000
2	M	M21038/27-05	Q1553-20						
3	T	M21038/27-05T	QT1553-20						
4	C	M21038/27-06C	QC1553-21	D	.250	1-5:6.2	1CT:1CT	1-5 2.5 6-2 2.8	(6-2) 3,000
5	M	M21038/27-06	Q1553-21						
6	T	M21038/27-06T	QT1553-21						
7	C	M21038/27-07C	QC1553-22	D	.250	1-5:6.2	1CT:1.41CT	1-5 2.2 6-2 2.7	(6-2) 3,000
8	M	M21038/27-07	Q1553-22						
9	T	M21038/27-07T	QT1553-22						
10	C	M21038/27-08C	QC1553-23	D	.250	1-5:6.2	1CT:1.66CT	1-5 1.5 6-2 2.4	(6-2) 3,000
11	M	M21038/27-08	Q1553-23						
12	T	M21038/27-08T	QT1553-23						
13	C	M21038/27-09C	QC1553-24	D	.250	1-5:6.2	1CT:2CT	1-5 1.3 6-2 2.6	(6-2) 3,000
14	M	M21038/27-09	Q1553-24						
15	T	M21038/27-09T	QT1553-24						
16	C	M21038/27-28C	QC1553-25*	D	.250	1-5:6.2	1CT:1.5CT	1-3 0.90 6-2 2.5	(6-2) 3,000
17	M	M21038/27-28	Q1553-25*						
18	T	M21038/27-28T	QT1553-25*						
19	C	M21038/27-29C	QC1553-51*	D	.250	1-5:6.2	1CT:1.79CT	1-5 0.90 6-2 2.5	(6-2) 3,000
20	M	M21038/27-29	Q1553-51*						
21	T	M21038/27-29T	QT1553-51*						
22	C	M21038/27-30C	QC1553-52*	D	.250	1-5:6.2	1CT:2.5CT	1-5 1.0 6-2 2.8	(6-2) 3,000
23	M	M21038/27-30	Q1553-52*						
24	T	M21038/27-30T	QT1553-52*						

*NOTE: Designed for transceivers utilizing a single supply voltage (+5V).

MIL-STD-1553 TRANSFORMERS

Single Ratio THT QPL Pulse Transformers



Package C

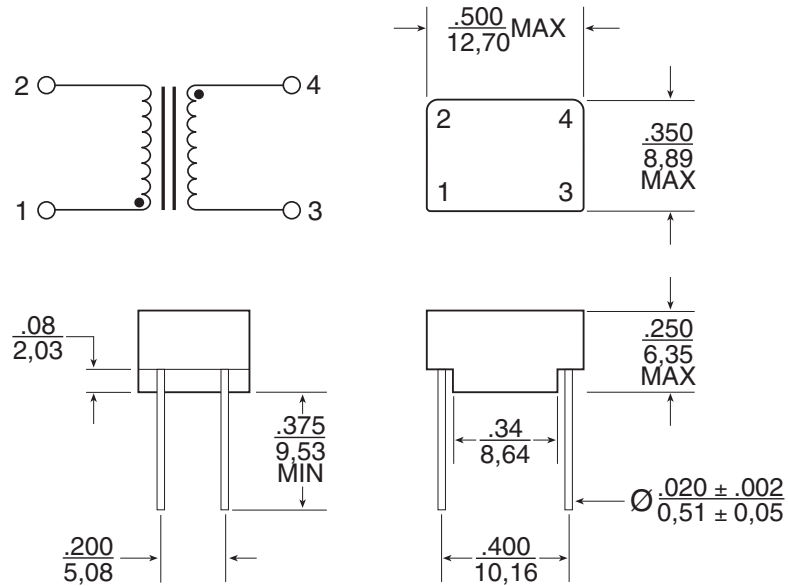

Package D

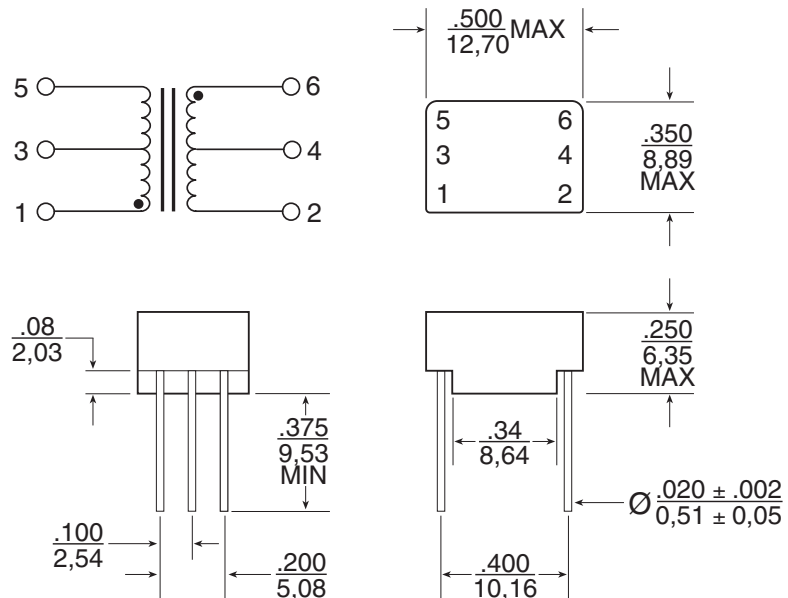





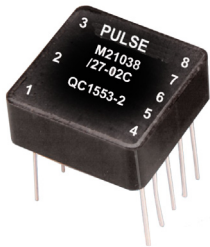

Notes:

1. All dimensions are in inches.
2. Tolerances: .xx = +.010, .xxx = +.008
3. All specifications and dimensions are subject to change without notice.

MIL-STD-1553 TRANSFORMERS

Dual Ratio THT QPL Pulse Transformers



-  Qualified for use in QPL MIL-STD-1553 applications
-  Dual ratio in a single package (see Schematic)
-  Designed, built, and tested to MIL-PRF-21038 Levels* C, M, and T
-  Two packages available: Package A without standoffs, and Package G with standoffs
-  Built in ISO 9001 facility
-  Applicable specifications

- MIL-STD-1553B
- MIL-STD-202
- MIL-PRF-21038
- ISO 9001

- * ■ **Level C** - for high reliability commercial/industrial applications
- **Level M** - for general purpose military applications
- **Level T** - for high reliability critical military applications

Summary Performance Specifications	
Impedance	(see next page)
Droop	≤ 20%
Overshoot	±1V MAX
Common Mode Rejection (CMR)	≥ 45dB
Frequency Range (no load)	75kHz to 1MHz
Operating Temperature Range	-55°C to 130°C
Weight	≤ 5 grams
Insulation Resistance (MIN)	10K MΩ @ 250Vdc
Dielectric Withstanding Voltage	100Vrms

Package A

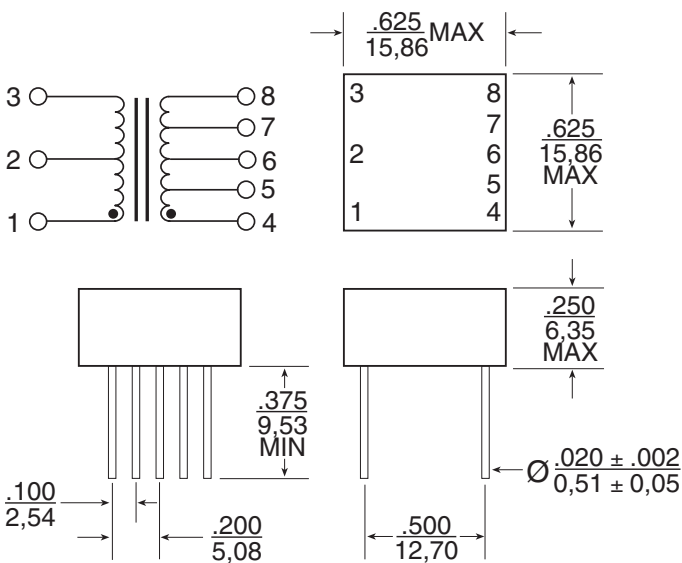

Package G

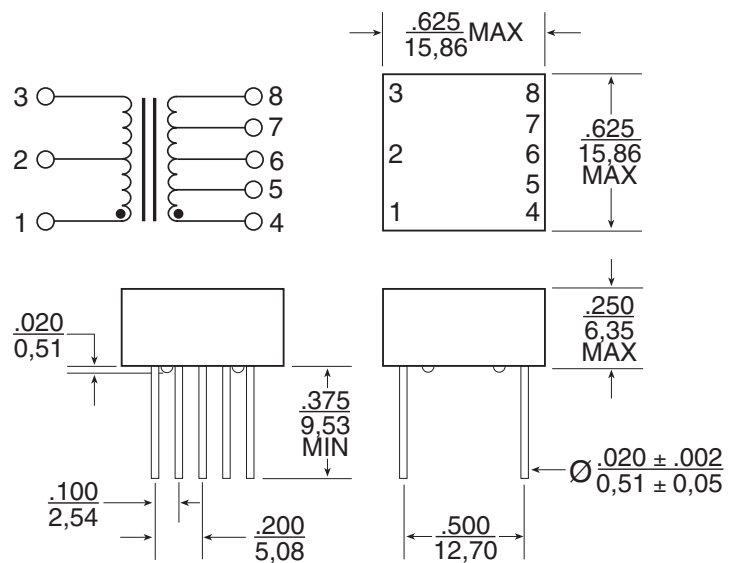

Notes:

1. All dimensions are in inches.
2. Tolerances: .xx = +.008
3. All specifications and dimensions are subject to change without notice.

MIL-STD-1553 TRANSFORMERS

Dual Ratio THT QPL Pulse Transformers







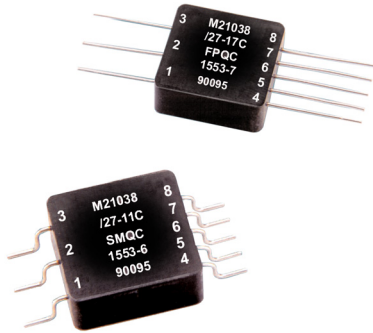

Characteristics									
Line	Level	Military Designation No.	Pulse Part No.	Package	Height (in. MAX)	Terminals	Ratio (±3%)	RDC (Ω MAX)	Impedance (Ω MIN)
1	C	M21038/27-01C	QC1553-1	A	.250	1-3:4-8	1CT:1CT	1-3 3.0	(1-3)
2	M	M21038/27-01	Q1553-1			1-3:5-7	1CT:.707CT	4-8 3.0	4,000
3	T	M21038/27-01T	QT1553-1						
4	C	M21038/27-02C	QC1553-2	A	.250	1-3:4-8	1.4CT:1CT	1-3 3.5	(1-3)
5	M	M21038/27-02	Q1553-2			1-3:5-7	2CT:1CT	4-8 3.0	7,200
6	T	M21038/27-02T	QT1553-2						
7	C	M21038/27-03C	QC1553-3	A	.250	1-3:4-8	1.25CT:1CT	1-3 3.2	(1-3)
8	M	M21038/27-03	Q1553-3			1-3:5-7	1.66CT:1CT	4-8 3.0	4,000
9	T	M21038/27-03T	QT1553-3						
10	C	M21038/27-10C	QC1553-5*	A	.250	1-3:4-8	1CT:2.12CT	1-3 1.0	(4-8)
11	M	M21038/27-10	Q1553-5*			1-3:5-7	1CT:1.5CT	4-8 3.5	4,000
12	T	M21038/27-10T	QT1553-5*						
13	C	M21038/27-21C	QC1553-81	G	.275	1-3:4-8	1CT:1CT	1-3 3.0	(1-3)
14	M	M21038/27-21	Q1553-81			1-3:5-7	1CT:.707CT	4-8 3.0	4,000
15	T	M21038/27-21T	QT1553-81						
16	C	M21038/27-22C	QC1553-82	G	.275	1-3:4-8	1.4CT:1CT	1-3 3.5	(1-3)
17	M	M21038/27-22	Q1553-82			1-3:5-7	2CT:1CT	4-8 3.0	7,200
18	T	M21038/27-22T	QT1553-82						
19	C	M21038/27-23C	QC1553-83	G	.275	1-3:4-8	1.25CT:1CT	1-3 3.2	(1-3)
20	M	M21038/27-23	Q1553-83			1-3:5-7	1.66CT:1CT	4-8 3.0	4,000
21	T	M21038/27-23T	QT1553-83						
22	C	M21038/27-24C	QC1553-84*	G	.275	1-3:4-8	1CT:2.12CT	1-3 1.0	(4-8)
23	M	M21038/27-24	Q1553-84*			1-3:5-7	1CT:1.5CT	4-8 3.5	4,000
24	T	M21038/27-24T	QT1553-84*						
25	C	M21038/27-25C	QC1553-85*	G	.275	1-3:4-8	1CT:2.50CT	1-3 1.0	(4-8)
26	M	M21038/27-25	Q1553-85*			1-3:5-7	1CT:1.79CT	4-8 3.5	4,000
27	T	M21038/27-25T	QT1553-85*						
28	C	M21038/27-26C	QC1553-45*	A	.250	1-3:4-8	1CT:2.50CT	1-3 1.0	(4-8)
29	M	M21038/27-26	Q1553-45*			1-3:5-7	1CT:1.79CT	4-8 3.5	4,000
30	T	M21038/27-26T	QT1553-45*						

*NOTE: Designed for transceivers utilizing a single supply voltage (+5V).

MIL-STD-1553 TRANSFORMERS

Dual Ratio SMT QPL Pulse Transformers



-  Qualified for use in QPL MIL-STD-1553 applications
-  Dual ratio in a single package (see Schematic)
-  Designed, built, and tested to MIL-PRF-21038 Levels* C, M, and T
-  Two packages available: Package B has gull-wing leads, and Package F is flat pack
-  Built in ISO 9001 facility
-  Applicable specifications

- MIL-STD-1553B
- MIL-STD-202
- MIL-PRF-21038
- ISO 9001

- * ■ **Level C** - for high reliability commercial/industrial applications
- **Level M** - for general purpose military applications
- **Level T** - for high reliability critical military applications

Summary Performance Specifications	
Impedance	(see next page)
Droop	≤ 20%
Overshoot	±1V MAX
Common Mode Rejection (CMR)	≥ 45dB
Frequency Range (no load)	75kHz to 1MHz
Operating Temperature Range	-55°C to 130°C
Weight	≤ 5 grams
Insulation Resistance (MIN)	10K MΩ @ 250Vdc
Dielectric Withstanding Voltage	100Vrms

Package B

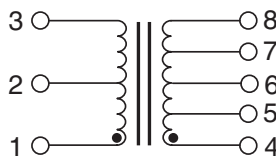

- Notes:**
1. All dimensions are in inches.
 2. Tolerances: .xx = +.008
 3. All specifications and dimensions are subject to change without notice.

Package F

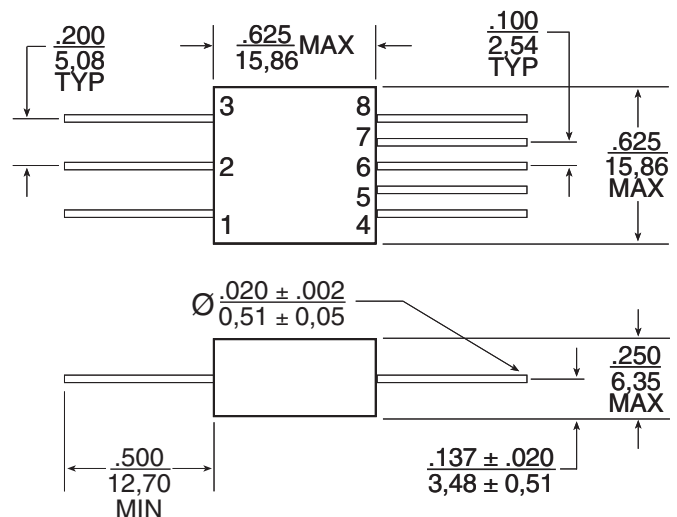
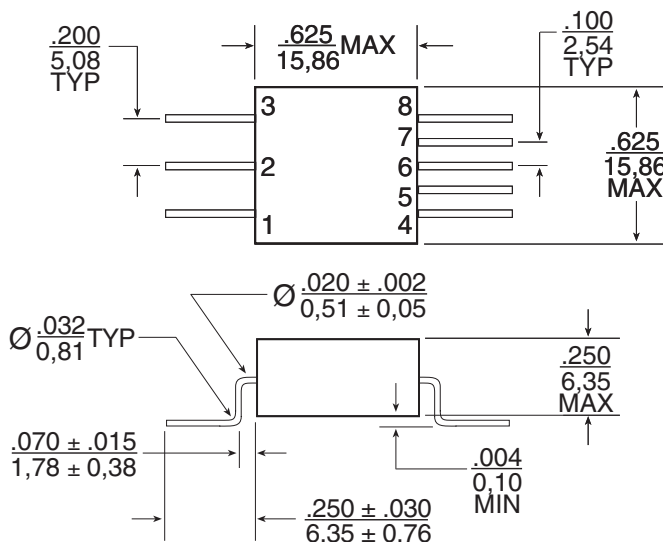
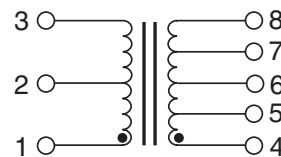

MIL-STD-1553 TRANSFORMERS

Dual Ratio SMT QPL Pulse Transformers



Characteristics									
Line	Level	Military Designation No.	Pulse Part No.	Package	Height (in. MAX)	Terminals	Ratio (±3%)	RDC (Ω MAX)	Impedance (Ω MIN)
1	C	M21038/27-11C	SMQC1553-6	B	.250	1-3:4-8	1CT:1CT	1-3 3.0	(1-3)
2	M	M21038/27-11	SMQ1553-6			1-3:5-7	1CT:.707CT	4-8 3.0	4,000
3	T	M21038/27-11T	SMQT1553-6						
4	C	M21038/27-12C	SMQC1553-7	B	.250	1-3:4-8	1.4CT:1CT	1-3 3.5	(1-3)
5	M	M21038/27-12	SMQ1553-7			1-3:5-7	2CT:1CT	4-8 3.0	7,200
6	T	M21038/27-12T	SMQT1553-7						
7	C	M21038/27-13C	SMQC1553-8	B	.250	1-3:4-8	1.25CT:1CT	1-3 3.2	(1-3)
8	M	M21038/27-13	SMQ1553-8			1-3:5-7	1.66CT:1CT	4-8 3.0	4,000
9	T	M21038/27-13T	SMQT1553-8						
10	C	M21038/27-15C	SMQC1553-10*	B	.250	1-3:4-8	1CT:2.12CT	1-3 1.0	(4-8)
11	M	M21038/27-15	SMQ1553-10*			1-3:5-7	1CT:1.5CT	4-8 3.5	4,000
12	T	M21038/27-15T	SMQT1553-10*						
13	C	M21038/27-16C	FPQC1553-6	F	.250	1-3:4-8	1CT:1CT	1-3 3.0	(1-3)
14	M	M21038/27-16	FPQ1553-6			1-3:5-7	1CT:.707CT	4-8 3.0	4,000
15	T	M21038/27-16T	FPQT1553-6						
16	C	M21038/27-17C	FPQC1553-7	F	.250	1-3:4-8	1.4CT:1CT	1-3 3.5	(1-3)
17	M	M21038/27-17	FPQ1553-7			1-3:5-7	2CT:1CT	4-8 3.0	7,200
18	T	M21038/27-17T	FPQT1553-7						
19	C	M21038/27-18C	FPQC1553-8	F	.250	1-3:4-8	1.25CT:1CT	1-3 3.2	(1-3)
20	M	M21038/27-18	FPQ1553-8			1-3:5-7	1.66CT:1CT	4-8 3.0	4,000
21	T	M21038/27-18T	FPQT1553-8						
22	C	M21038/27-20C	FPQC1553-10*	F	.250	1-3:4-8	1CT:2.12CT	1-3 1.0	(4-8)
23	M	M21038/27-20	FPQ1553-10*			1-3:5-7	1CT:1.5CT	4-8 3.5	4,000
24	T	M21038/27-20T	FPQT1553-10*						
25	C	M21038/27-27C	SMQC1553-45*	B	.250	1-3:4-8	1CT:2.50CT	1-3 1.0	(4-8)
26	M	M21038/27-27	SMQ1553-45*			1-3:5-7	1CT:1.79CT	4-8 3.5	4,000
27	T	M21038/27-27T	SMQT1553-45*						
28	C	M21038/27-31C	FPQC1553-45*	F	.250	1-3:4-8	1CT:2.50CT	1-3 1.0	(4-8)
29	M	M21038/27-31	FPQ1553-45*			1-3:5-7	1CT:1.79CT	4-8 3.5	4,000
30	T	M21038/27-31T	FPQT1553-45*						

*NOTE: Designed for transceivers utilizing a single supply voltage (+5V).

MIL-STD-1553 TRANSFORMERS

non-QPL Interface Transformers Overview



COTS Transformers

Pulse has developed many low-power pulse transformer products in response to the Perry Initiative and its COTS mandate. Several of our QPL transformers have COTS counterparts. They have the same component layout and electrical characteristics but they're built for

commercially-oriented requirements, and manufactured in higher volume at lower cost. We've noted where a COTS counterpart to a QPL product exists with the symbol shown here.



More non-QPL 1553 Transformers

Other non-QPL pulse transformers available have performance and electrical characteristics compliant with MIL-PRF-21038/27, but have been developed for special applications:

- Low profile for reduced board-stacking height
- Single- ratio and dual-ratio
- Single interface and dual interface
- Vertically stacked dual interface
- 0-70°C or -40 to +85°C or -55 to +125°C
- Hermetically sealed for extreme environments

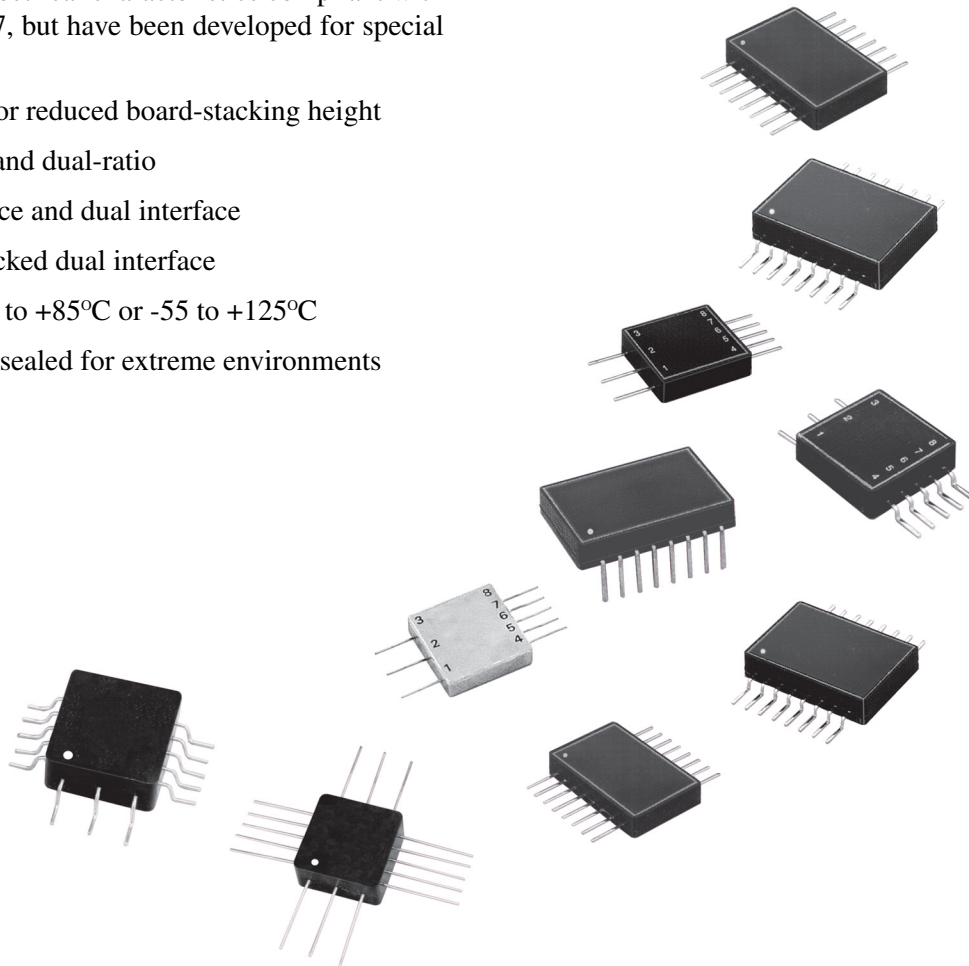

MIL-STD-1553 TRANSFORMERS

non-QPL Interface Transformers Overview

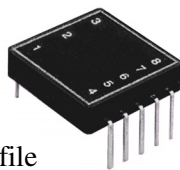

- Low profile
 - Dual ratio
 - Through-the-board
- See page 12*

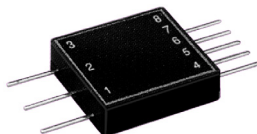

- Low profile
 - Dual ratio
 - Surface-mount flat pack
- See page 13*

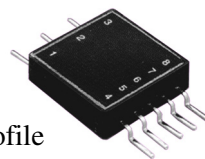

- Low profile
 - Dual ratio
 - Surface-mount gull wing
- See page 13*

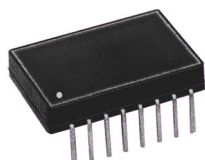

- Dual interface
 - Low profile
 - Dual ratio
 - Through-the-board
- See page 14*

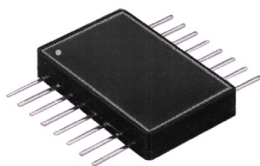

- Dual interface
 - Low profile
 - Dual ratio
 - Surface-mount flat pack
- See page 15*

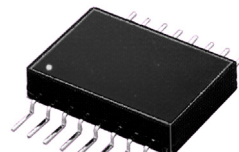

- Dual interface
 - Low profile
 - Dual ratio
 - Surface-mount gull wing
- See page 15*

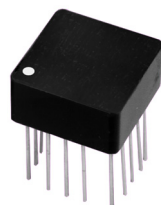

- Dual interface
 - Stacked
 - Dual ratio
 - Through-the-board
- See page 16*

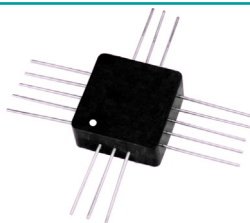

- Dual interface
 - Stacked
 - Dual ratio
 - Surface-mount flat pack
- See page 17*

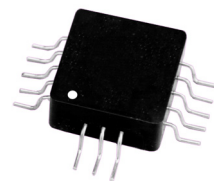

- Dual interface
 - Stacked
 - Dual ratio
 - Surface-mount gull wing
- See page 17*

Hermetically Sealed

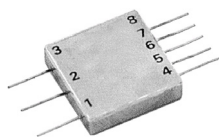

- Single interface
 - Dual ratio
 - Surface-mount flat pack
- See page 18*

Value Series – COTS

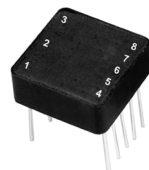

- Standard profile
 - Dual-ratio
 - Through-the-board
- See page 19*



The package shown here as “Value Series COTS” is also available fully qualified to MIL-PRF-21038/27 requirements. *See page 6*

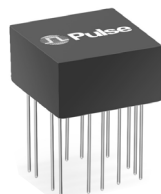

- Dual interface
 - Low profile
 - Dual ratio
 - Through-the-board
- See page 20-21*

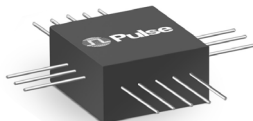

- Dual interface
 - Low profile
 - Dual ratio
 - Surface-mount flat pack
- See page 20-21*

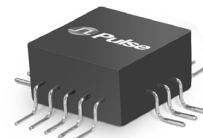





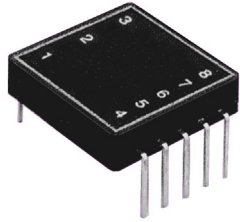

- Dual interface
 - Low profile
 - Dual ratio
 - Surface-mount gull wing
- See page 20-21*

MIL-STD-1553 TRANSFORMERS

Low Profile THT non-QPL Interface Transformers



These non-QPL interface transformers are built and tested in ISO 9001 approved facilities. They conform to all electrical and physical parameters of MIL-PRF-21038/27. Choose one of three operating temperature ranges including 0° to +70°C, -40° to +85°C, or -55° to +125°C.

-  Dual ratio, single interface (see schematic)
-  Through-the-board package
-  For use in MIL-STD-1553 applications
-  Low profile, 0.155 inches height
-  Performance to MIL-PRF-21038 requirements
-  Built in ISO 9001 facility
-  Applicable specifications:

Operating Temp.	Prefix
0° to 70°C	TLC
-40° to +85°C	TLN
-55° to +125°C	TL

- MIL-STD-1553B
- MIL-PRF-21038
- MIL-STD-202
- ISO 9001

Summary Performance Specifications	
Impedance	(see table below)
Droop	≤ 20%
Overshoot	±1V MAX
Common Mode Rejection (CMR)	≥ 45dB
Frequency Range (no load)	75kHz to 1MHz
Operating Temperature Range	(see table above)
Weight	≤ 5 grams
Insulation Resistance (MIN)	10K MΩ @ 250Vdc
Dielectric Withstanding Voltage	100Vrms

Schematic

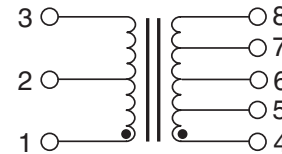

Characteristics

Part Number ¹	Terminals	Ratio (±3%)	RDC (Ω MAX)	Impedance (Ω MIN)
(XXX)1553-1	1-3 : 4-8 1-3 : 5-7	1CT:1CT 1CT:707CT	1-3 = 3.0 4-8 = 3.0	(1-3) 4,000
(XXX)1553-2	1-3 : 4-8 1-3 : 5-7	1.4CT:1CT 2CT:1CT	1-3 = 3.5 4-8 = 3.0	(1-3) 7,200
(XXX)1553-3	1-3 : 4-8 1-3 : 5-7	1.25CT:1CT 1.66CT:1CT	1-3 = 3.2 4-8 = 3.0	(1-3) 4,000
(XXX)1553-5 ²	1-3 : 4-8 1-3 : 5-7	1CT:2.12CT 1CT:1.5CT	1-3 = 1.0 4-8 = 3.5	(4-8) 4,000
(XXX)1553-45 ²	1-3 : 4-8 1-3 : 5-7	1CT:2.5CT 1CT:1.79CT	1-3 = 1.0 4-8 = 3.5	(4-8) 4,000

NOTE: 1. Refer to prefix table (above) to select temperature range. 2. Designed for transceivers utilizing a single supply voltage (+5V).

Mechanical

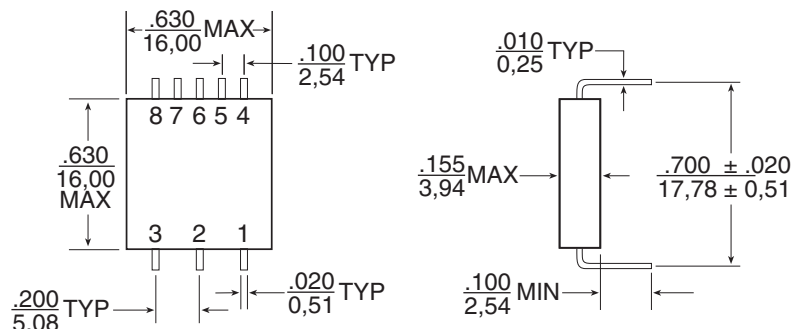

Notes:

1. All dimensions are in inches.
2. Tolerances: .xx = +.008
3. All specifications and dimensions are subject to change without notice.

USA 858 674 8100 • Germany 49 7032 7806 0 • Singapore 65 6287 8998 • Shanghai 86 21 32181071 • China 86 755 33966678 • Taiwan 886 3 4643715

MIL-STD-1553 TRANSFORMERS

Low Profile SMT non-QPL Interface Transformers

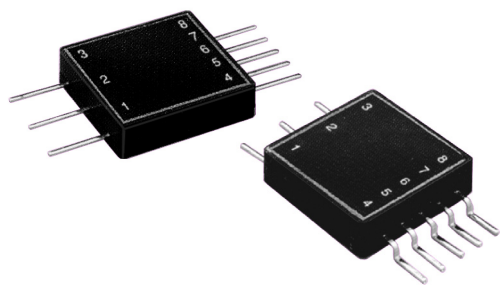

These non-QPL interface transformers are built and tested in ISO 9001 approved facilities. They conform to all electrical and physical parameters of MIL-PRF-21038/27. Choose one of three operating temperature ranges including 0° to +70°C, -40° to +85°C, or -55° to +125°C.

- Dual ratio, single interface (see schematic)
- Surface Mount, flat pack or gull wing package
- For use in MIL-STD-1553 applications
- Low profile, 0.155 inches height
- Performance to MIL-PRF-21038 requirements
- Built in ISO 9001 facility
- Applicable specifications:

Operating Temperature	Flat Pack Prefix	Gull Wing Prefix
0° to 70°C	FLC	GLC
-40° to +85°C	FLN	GLN
-55° to +125°C	FL	GL

- MIL-STD-1553B
- MIL-PRF-21038
- MIL-STD-202
- ISO 9001

Summary Performance Specifications

Impedance	(see table below)
Drop	≤ 20%
Overshoot	±1V MAX
Common Mode Rejection (CMR)	≥ 45dB
Frequency Range (no load)	75kHz to 1MHz
Operating Temperature Range	(see table above)
Weight	≤ 5 grams
Insulation Resistance (MIN)	10K MΩ @ 250Vdc
Dielectric Withstanding Voltage	100Vrms

Schematic

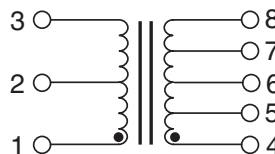

Characteristics

Part Number ¹	Terminals	Ratio (±3%)	RDC (Ω MAX)	Impedance (Ω MIN)
(XXX)1553-1	1-3 : 4-8 1-3 : 5-7	1CT:1CT 1CT:707CT	1-3 = 3.0 4-8 = 3.0	(1-3) 4,000
(XXX)1553-2	1-3 : 4-8 1-3 : 5-7	1.4CT:1CT 2CT:1CT	1-3 = 3.5 4-8 = 3.0	(1-3) 7,200
(XXX)1553-3	1-3 : 4-8 1-3 : 5-7	1.25CT:1CT 1.66CT:1CT	1-3 = 3.2 4-8 = 3.0	(1-3) 4,000
(XXX)1553-5 ²	1-3 : 4-8 1-3 : 5-7	1CT:2.12CT 1CT:1.5CT	1-3 = 1.0 4-8 = 3.5	(4-8) 4,000
(XXX)1553-45 ²	1-3 : 4-8 1-3 : 5-7	1CT:2.5CT 1CT:1.79CT	1-3 = 1.0 4-8 = 3.5	(4-8) 4,000

NOTE: 1. Refer to prefix table (above) to select temperature range. 2. Designed for transceivers utilizing a single supply voltage (+5V).

Mechanicals

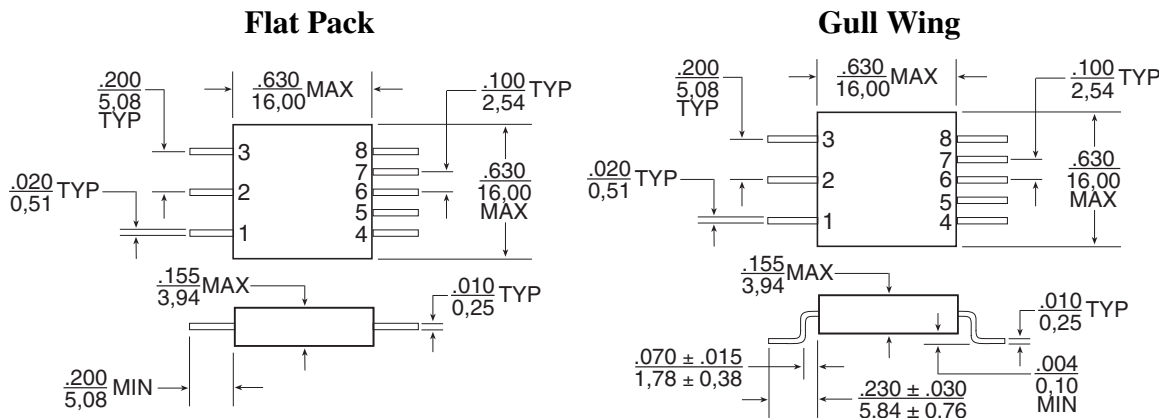

Notes:

1. All dimensions: in inches.
2. Tolerances: .xx = +.008
3. All specifications and dimensions are subject to change without notice.

MIL-STD-1553 TRANSFORMERS



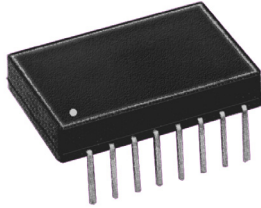



Low Profile Dual THT non-QPL Interface Transformers



These non-QPL interface transformers are built and tested in ISO 9001 approved facilities. They conform to all electrical and physical parameters of MIL-PRF-21038/27. Choose one of three operating temperature ranges including 0° to +70°C, -40° to +85°C, or -55° to +125°C.

Operating Temp.	Prefix
0° to 70°C	DTLC
-40° to +85°C	DTLN
-55° to +125°C	DTL

Summary Performance Specifications	
Impedance	(see table below)
Drop	≤ 20%
Overshoot	±1V MAX
Common Mode Rejection (CMR)	≥ 45dB
Frequency Range (no load)	75kHz to 1MHz
Operating Temperature Range	(see table above)
Weight	≤ 5 grams
Insulation Resistance (MIN)	10K MΩ @ 250Vdc
Dielectric Withstanding Voltage	100Vrms

-  Dual ratio, dual interface (see schematic)
-  Through-the-board package
-  For use in MIL-STD-1553 applications
-  Low profile, 0.155 inches height
-  Performance to MIL-PRF-21038 requirements
-  Built in ISO 9001 facility
-  Applicable specifications:

- MIL-STD-1553B
- MIL-STD-202
- MIL-PRF-21038
- ISO 9001

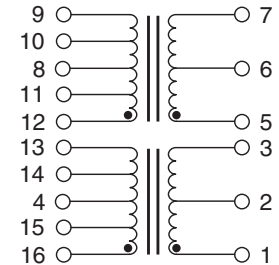

Schematic

Characteristics				
Part Number ¹	Terminals	Ratio (±3%)	RDC (Ω MAX)	Impedance (Ω MIN)
(XXXX)1553-1	1-3 : 16-13 / 5-7 : 12-9	1CT:1CT	1-3, 5-7 = 3.0	(1-3, 5-7)
	1-3 : 15-14 / 5-7 : 11-10	1CT:.707CT	16-13, 12-9 = 3.0	4,000
(XXXX)1553-2	1-3 : 16-13 / 5-7 : 12-9	1.4CT:1CT	1-3, 5-7 = 3.5	(1-3, 5-7)
	1-3 : 15-14 / 5-7 : 11-10	2CT:1CT	16-13, 12-9 = 3.0	7,200
(XXXX)1553-3	1-3 : 16-13 / 5-7 : 12-9	1.25CT:1CT	1-3, 5-7 = 3.2	(1-3, 5-7)
	1-3 : 15-14 / 5-7 : 11-10	1.66CT:1CT	16-13, 12-9 = 3.0	4,000
(XXXX)1553-5 ²	1-3 : 16-13 / 5-7 : 12-9	1CT:2.12CT	1-3, 5-7 = 1.0	(16-13, 12-9)
	1-3 : 15-14 / 5-7 : 11-10	1CT:1.5CT	16-13, 12-9 = 3.5	4,000
(XXXX)1553-45 ²	1-3 : 16-13 / 5-7 : 12-9	1CT:2.5CT	1-3, 5-7 = 1.0	(16-13, 12-9)
	1-3 : 15-14 / 5-7 : 11-10	1CT:1.79CT	16-13, 12-9 = 3.5	4,000

NOTE: 1. Refer to prefix table (above) to select temperature range. 2. Designed for transceivers utilizing a single supply voltage (+5V).

Mechanical

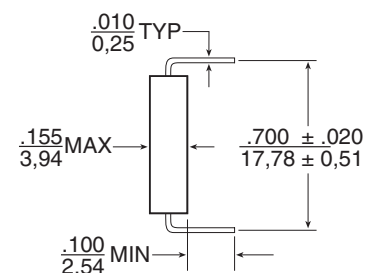
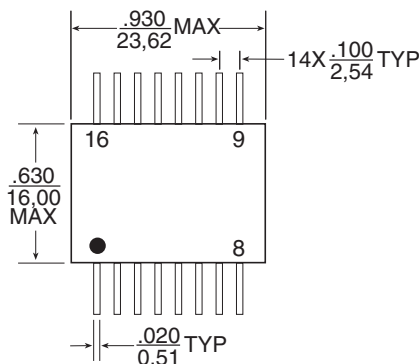

Notes:

1. All dimensions are in inches.
2. Tolerances: .xx = +.008
3. All specifications and dimensions are subject to change without notice.

MIL-STD-1553 TRANSFORMERS

Low Profile SMT Dual non-QPL Interface Transformers

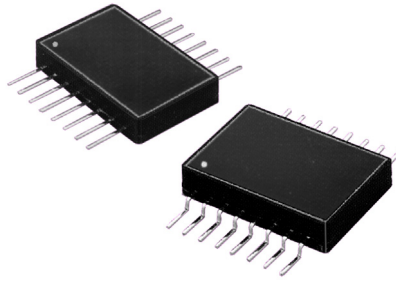

These non-QPL interface transformers are built and tested in ISO 9001 approved facilities. They conform to all electrical and physical parameters of MIL-PRF-21038/27. Choose one of three operating temperature ranges including 0° to +70°C, -40° to +85°C, or -55° to +125°C.

Operating Temperature	Flat Pack Prefix	Gull Wing Prefix
0° to 70°C	DFLC	DGLC
-40° to +85°C	DFLN	DGLN
-55° to +125°C	DFL	DGL

Summary Performance Specifications	
Impedance	(see table below)
Droop	≤ 20%
Overshoot	±1V MAX
Common Mode Rejection (CMR)	≥ 45dB
Frequency Range (no load)	75kHz to 1MHz
Operating Temperature Range	(see table above)
Weight	≤ 5 grams
Insulation Resistance (MIN)	10K MΩ @ 250Vdc
Dielectric Withstanding Voltage	100Vrms

- Dual ratio, dual interface (see schematic)
- Surface Mount, flat pack or gull wing package
- For use in MIL-STD-1553 applications
- Low profile, 0.155 inches height
- Performance to MIL-PRF-21038 requirements
- Built in ISO 9001 facility
- Applicable specifications:

- MIL-STD-1553B
- MIL-STD-202
- MIL-PRF-21038
- ISO 9001

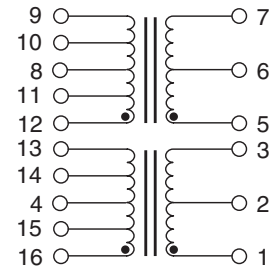

Schematic

Characteristics				
Part Number ¹	Terminals	Ratio (±3%)	RDC (Ω MAX)	Impedance (Ω MIN)
(XXXX)1553-1	1-3 : 16-13 / 5-7 : 12-9	1CT:1CT	1-3, 5-7 = 3.0	(1-3, 5-7) 4,000
	1-3 : 15-14 / 5-7 : 11-10	1CT:1.707CT	16-13, 12-9 = 3.0	
(XXXX)1553-2	1-3 : 16-13 / 5-7 : 12-9	1.4CT:1CT	1-3, 5-7 = 3.5	(1-3, 5-7)
	1-3 : 15-14 / 5-7 : 11-10	2CT:1CT	16-13, 12-9 = 3.0	7,200
(XXXX)1553-3	1-3 : 16-13 / 5-7 : 12-9	1.25CT:1CT	1-3, 5-7 = 3.2	(1-3, 5-7)
	1-3 : 15-14 / 5-7 : 11-10	1.66CT:1CT	16-13, 12-9 = 3.0	4,000
(XXXX)1553-5 ²	1-3 : 16-13 / 5-7 : 12-9	1CT:2.12CT	1-3, 5-7 = 1.0	(16-13, 12-9)
	1-3 : 15-14 / 5-7 : 11-10	1CT:1.5CT	16-13, 12-9 = 3.5	4,000
(XXXX)1553-45 ²	1-3 : 16-13 / 5-7 : 12-9	1CT:2.5CT	1-3, 5-7 = 1.0	(16-13, 12-9)
	1-3 : 15-14 / 5-7 : 11-10	1CT:1.79CT	16-13, 12-9 = 3.5	4,000

NOTE: 1. Refer to prefix table (above) to select temperature range. 2. Designed for transceivers utilizing a single supply voltage (+5V).

Mechanicals

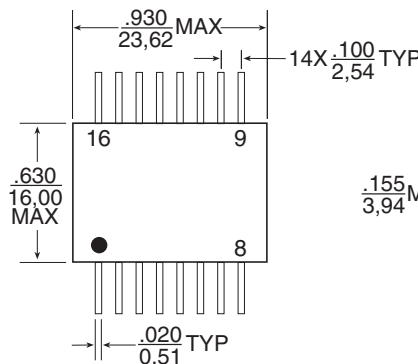

- Notes:
- All dimensions are in inches.
 - Tolerances: .xx = +.008
 - All specifications and dimensions are subject to change without notice.

Flat Pack

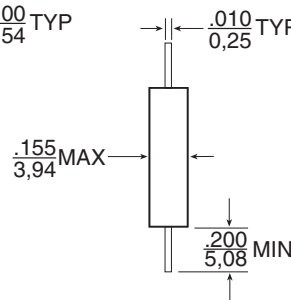

Gull Wing

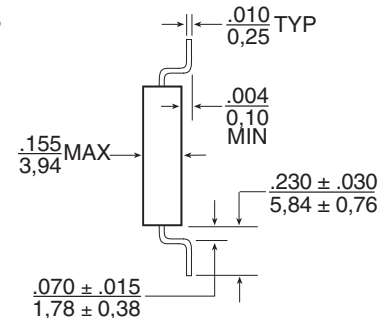

MIL-STD-1553 TRANSFORMERS



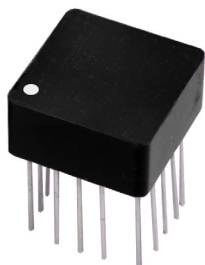



Stacked Dual THT non-QPL Interface Transformers



These non-QPL interface transformers are built and tested in ISO 9001 approved facilities. They conform to all electrical and physical parameters of MIL-PRF-21038/27. Choose one of three operating temperature ranges including 0° to +70°C, -40° to +85°C, or -55° to +125°C.

Operating Temp.	Prefix
0° to 70°C	STQC
-40° to +85°C	STQN
-55° to +125°C	STQ

Summary Performance Specifications	
Impedance	(see table below)
Droop	≤ 20%
Overshoot	±1V MAX
Common Mode Rejection (CMR)	≥ 45dB
Frequency Range (no load)	75kHz to 1MHz
Operating Temperature Range	(see table above)
Weight	≤ 5 grams
Insulation Resistance (MIN)	10K MΩ @ 250Vdc
Dielectric Withstanding Voltage	100Vrms

-  Dual ratio, dual interface (see schematic)
-  Through-the-board package
-  For use in MIL-STD-1553 applications
-  Vertically stacked for minimum XY area
-  Performance to MIL-PRF-21038 requirements
-  Built in ISO 9001 facility
-  Applicable specifications:

- MIL-STD-1553B
- MIL-STD-202
- MIL-PRF-21038
- ISO 9001

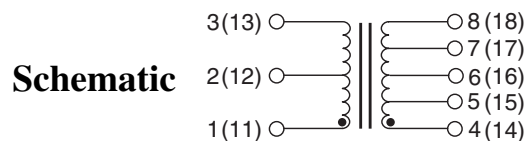

Characteristics				
Part Number ¹	Terminals	Ratio (±3%)	RDC (Ω MAX)	Impedance (Ω MIN)
(XXXX)1553-1	1-3 : 4-8 (11-13 : 14-18) 1-3 : 5-7 (11-13 : 15-17)	1CT:1CT 1CT:.707CT	1-3 (11-13) = 3.5 4-8 (14-18) = 3.0	(1-3 & 11-13) 4,000
(XXXX)1553-2	1-3 : 4-8 (11-13 : 14-18) 1-3 : 5-7 (11-13 : 15-17)	1.4CT:1CT 2CT:1CT	1-3 (11-13) = 3.0 4-8 (14-18) = 3.0	(1-3 & 11-13) 7,200
(XXXX)1553-3	1-3 : 4-8 (11-13 : 14-18) 1-3 : 5-7 (11-13 : 15-17)	1.25CT:1CT 1.66CT:1CT	1-3 (11-13) = 3.2 4-8 (14-18) = 3.0	(1-3 & 11-13) 4,000
(XXXX)1553-5 ²	1-3 : 4-8 (11-13 : 14-18) 1-3 : 5-7 (11-13 : 15-17)	1CT:2.12CT 1CT:1.5CT	1-3 (11-13) = 1.0 4-8 (14-18) = 3.5	(4-8 & 14-18) 4,000
(XXXX)1553-45 ²	1-3 : 4-8 (11-13 : 14-18) 1-3 : 5-7 (11-13 : 15-17)	1CT:2.5CT 1CT:1.79CT	1-3 (11-13) = 1.0 4-8 (14-18) = 3.5	(4-8 & 14-18) 4,000

NOTE: 1. Refer to prefix table (above) to select temperature range. 2. Designed for transceivers utilizing a single supply voltage (+5V).

Mechanical

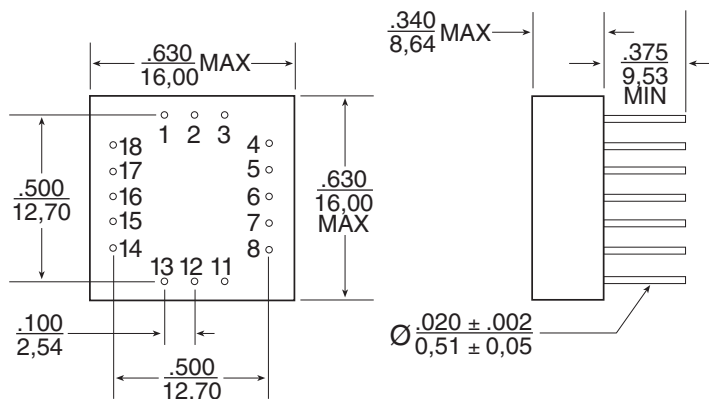

- Notes:**
- All dimensions: in inches.
 - Tolerances: .xx = +.008
 - All specifications and dimensions are subject to change without notice.

MIL-STD-1553 TRANSFORMERS

Stacked Dual SMT non-QPL Interface Transformers

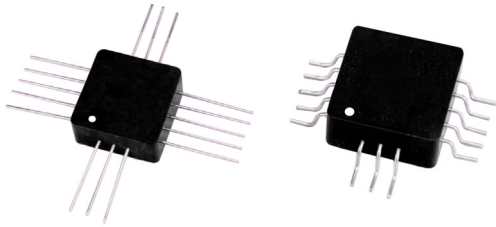

These non-QPL interface transformers are built and tested in ISO 9001 approved facilities. They conform to all electrical and physical parameters of MIL-PRF-21038/27. Choose one of three operating temperature ranges including 0° to +70°C, -40° to +85°C, or -55° to +125°C.

Operating Temperature	Flat Pack Prefix	Gull Wing Prefix
0° to 70°C	SFQC	SGQC
-40° to +85°C	SFQN	SGQN
-55° to +125°C	SFQ	SGQ

Summary Performance Specifications	
Impedance	(see table below)
Drop	≤ 20%
Overshoot	±1V MAX
Common Mode Rejection (CMR)	≥ 45dB
Frequency Range (no load)	75kHz to 1MHz
Operating Temperature Range	(see table above)
Weight	≤ 5 grams
Insulation Resistance (MIN)	10K MΩ @ 250Vdc
Dielectric Withstanding Voltage	100Vrms

- Dual ratio, dual interface (see schematic)
- Surface Mount package
- For use in MIL-STD-1553 applications
- Vertically stacked for minimum XY area
- Performance to MIL-PRF-21038 requirements
- Built in ISO 9001 facility
- Applicable specifications:

- MIL-STD-1553B
- MIL-STD-202
- MIL-PRF-21038
- ISO 9001

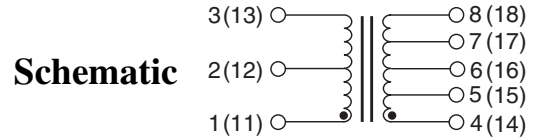

Characteristics				
Part Number ¹	Terminals	Ratio (±3%)	RDC (Ω MAX)	Impedance (Ω MIN)
(XXXX)1553-1	1-3 : 4-8 (11-13 : 14-18) 1-3 : 5-7 (11-13 : 15-17)	1CT:1CT 1CT:.707CT	1-3 (11-13) = 3.5 4-8 (14-18) = 3.0	(1-3 & 11-13) 4,000
(XXXX)1553-2	1-3 : 4-8 (11-13 : 14-18) 1-3 : 5-7 (11-13 : 15-17)	1.4CT:1CT 2CT:1CT	1-3 (11-13) = 3.0 4-8 (14-18) = 3.0	(1-3 & 11-13) 7,200
(XXXX)1553-3	1-3 : 4-8 (11-13 : 14-18) 1-3 : 5-7 (11-13 : 15-17)	1.25CT:1CT 1.66CT:1CT	1-3 (11-13) = 3.2 4-8 (14-18) = 3.0	(1-3 & 11-13) 4,000
(XXXX)1553-5 ²	1-3 : 4-8 (11-13 : 14-18) 1-3 : 5-7 (11-13 : 15-17)	1CT:2.12CT 1CT:1.5CT	1-3 (11-13) = 1.0 4-8 (14-18) = 3.5	(4-8 & 14-18) 4,000
(XXXX)1553-45 ²	1-3 : 4-8 (11-13 : 14-18) 1-3 : 5-7 (11-13 : 15-17)	1CT:2.5CT 1CT:1.79CT	1-3 (11-13) = 1.0 4-8 (14-18) = 3.5	(4-8 & 14-18) 4,000

NOTE: 1. Refer to prefix table (above) to select temperature range. 2. Designed for transceivers utilizing a single supply voltage (+5V).

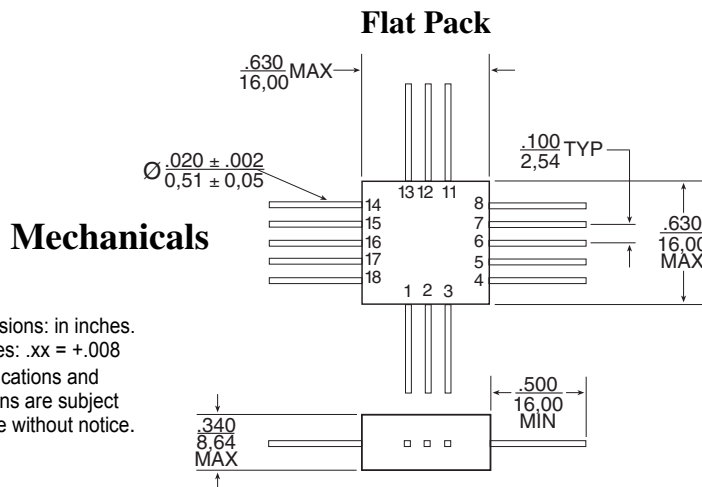

- Notes:**
- All dimensions: in inches.
 - Tolerances: .xx = +.008
 - All specifications and dimensions are subject to change without notice.

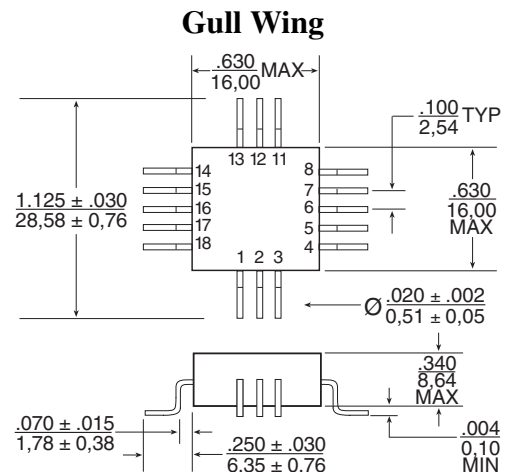





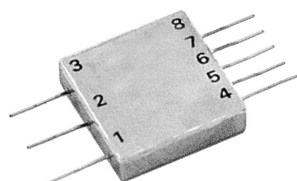





MIL-STD-1553 TRANSFORMERS

Hermetically-sealed SMT Dual non-QPL Interface Transformers



These hermetically sealed non-QPL interface transformers are built and tested in ISO 9001 approved facilities. They conform to all electrical and physical parameters of MIL-PRF-21038/27 and provide performance as required over -55° to $+125^{\circ}\text{C}$.

-  Dual ratio, single interface (see schematic)
-  Surface Mount, flat pack package
-  For use in MIL-STD-1553 applications
-  Performance to MIL-PRF-21038 requirements
-  Built in ISO 9001 facility
-  Applicable specifications:
 -  MIL-STD-1553B
 -  MIL-STD-202
 -  MIL-PRF-21038
 -  ISO 9001

Summary Performance Specifications	
Impedance	(see table below)
Droop	$\leq 20\%$
Overshoot	$\pm 1\text{V MAX}$
Common Mode Rejection (CMR)	$\geq 45\text{dB}$
Frequency Range (no load)	75kHz to 1MHz
Operating Temperature Range	-55° to $+125^{\circ}\text{C}$
Weight	≤ 5 grams
Insulation Resistance (MIN)	10K M Ω @ 250Vdc
Dielectric Withstanding Voltage	100Vrms

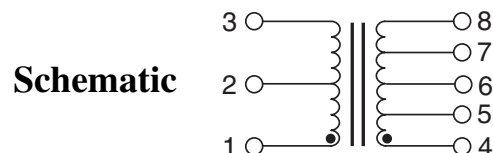

Characteristics				
Part Number	Terminals	Ratio ($\pm 3\%$)	RDC (Ω MAX)	Impedance (Ω MIN)
H1553-1	1-3 : 4-8	1CT:1CT	1-3 = 3.0	(1-3)
	1-3 : 5-7	1CT:.707CT	4-8 = 3.0	4,000
H1553-2	1-3 : 4-8	1.4CT:1CT	1-3 = 3.5	(1-3)
	1-3 : 5-7	2CT:1CT	4-8 = 3.0	7,200
H1553-3	1-3 : 4-8	1.25CT:1CT	1-3 = 3.2	(1-3)
	1-3 : 5-7	1.66CT:1CT	4-8 = 3.0	4,000
H1553-5 ¹	1-3 : 4-8	1CT:2.12CT	1-3 = 1.0	(4-8)
	1-3 : 5-7	1CT:1.5CT	4-8 = 3.5	4,000
H1553-45 ¹	1-3 : 4-8	1CT:2.5CT	1-3 = 1.0	(4-8)
	1-3 : 5-7	1CT:1.79CT	4-8 = 3.5	4,000

NOTE: 1. Designed for transceivers utilizing a single supply voltage (+5V).

Mechanical

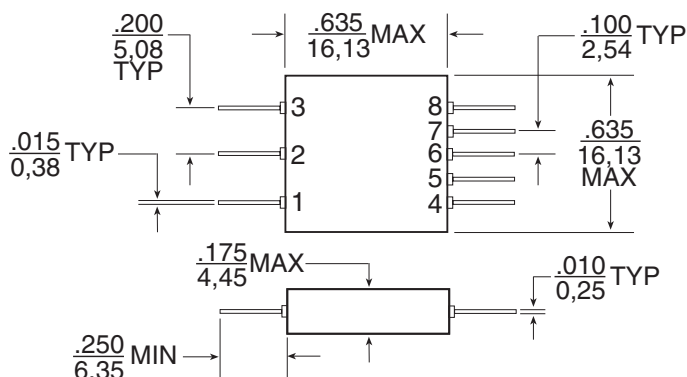

Notes:

1. All dimensions are in inches.
2. Tolerances: .xx = +.008
3. All specifications and dimensions are subject to change without notice.

MIL-STD-1553 TRANSFORMERS



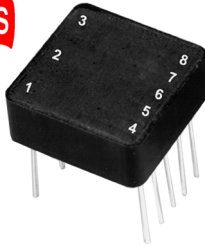



Value Series (COTS) THT non-QPL Interface Transformers



These non-QPL interface transformers are built and tested in ISO 9001 approved facilities. They conform to all electrical and physical parameters of MIL-PRF-21038/27. Choose one of three operating temperature ranges including 0° to +70°C, -40° to +85°C, or -55° to +125° C.

Operating Temp.	Prefix
0° to 70°C	C
-40° to +85°C	N
-55° to +125°C	TQ

Summary Performance Specifications	
Impedance	(see table below)
Droop	≤ 20%
Overshoot	±1V MAX
Common Mode Rejection (CMR)	≥ 45dB
Frequency Range (no load)	75kHz to 1MHz
Operating Temperature Range	(see table above)
Weight	≤ 5 grams
Insulation Resistance (MIN)	10K MΩ @ 250Vdc
Dielectric Withstanding Voltage	100Vrms

-  Dual ratio, single interface (see schematic)
-  Through-the-board package
-  For use in MIL-STD-1553 applications
-  Standard height: 0.250 in.
-  Performance to MIL-PRF-21038 requirements
-  Built in ISO 9001 facility
-  Applicable specifications:
 - MIL-STD-1553B
 - MIL-STD-202
 - MIL-PRF-21038
 - ISO 9001

Schematic

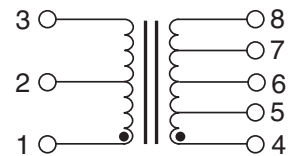

Characteristics				
Part Number	Terminals	Ratio (±3%)	RDC (Ω MAX)	Impedance (Ω MIN)
(X)1553-1 ¹	1-3 : 4-8	1CT:1CT	1-3 = 3.0	(1-3)
	1-3 : 5-7	1CT:.707CT	4-8 = 3.0	4,000
(X)1553-2	1-3 : 4-8	1.4CT:1CT	1-3 = 3.5	(1-3)
	1-3 : 5-7	2CT:1CT	4-8 = 3.0	7,200
(X)1553-3	1-3 : 4-8	1.25CT:1CT	1-3 = 3.2	(1-3)
	1-3 : 5-7	1.66CT:1CT	4-8 = 3.0	4,000
(X)1553-5 ²	1-3 : 4-8	1CT:2.12CT	1-3 = 1.0	(4-8)
	1-3 : 5-7	1CT:1.5CT	4-8 = 3.5	4,000
(X)1553-45 ²	1-3 : 4-8	1CT:2.5CT	1-3 = 1.0	(4-8)
	1-3 : 5-7	1CT:1.79CT	4-8 = 3.5	4,000

NOTE: 1. Refer to prefix table (above) to select temperature range. 2. Designed for transceivers utilizing a single supply voltage (+5V).

Mechanical

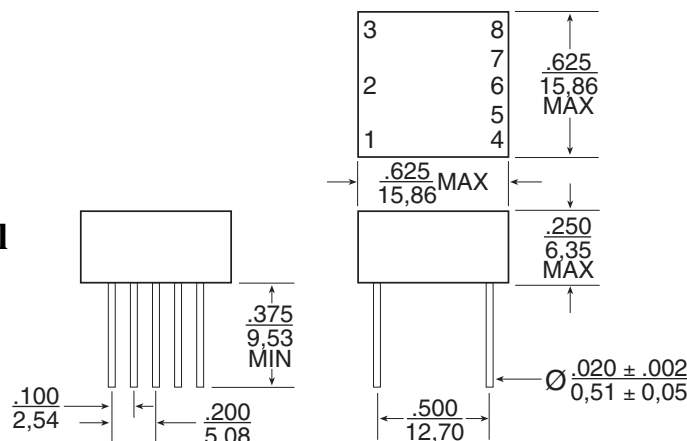





Notes:

1. All dimensions: in inches.
2. Tolerances: .xx = +.008
3. All specifications and dimensions are subject to change without notice.

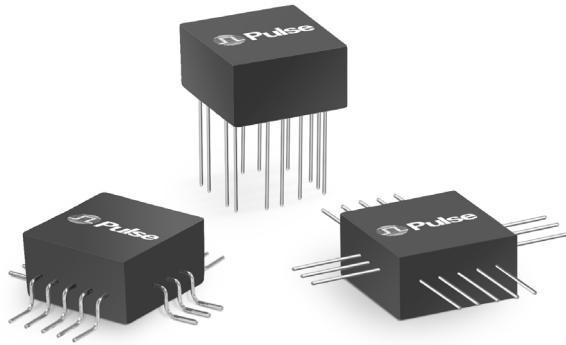
MIL-STD-1553 TRANSFORMERS

Low Profile / Stacked Dual THT and SMT non-QPL Interface Transformers



-  Built and tested to MIL-PRF-21038
-  Withstands 220°C IR/Reflow temperature
-  Operating & storage temperature:
-55°C to +130°C
-  Through-hole, Flat-pack and SMT mount configurations

Electrical Specifications

Part Number	Terminal Configuration	Ratio (±3%)	RDC (Ω MAX)	Impedance (Ω MIN)	Drop	Overshoot (MAX)	Common Mode Rejection (CMR)	Frequency Range (no load)	Insulation Resistance (mΩ MIN)	Dielectric Withstanding Voltage	
THROUGH-HOLE											
SLQT1553-1	1-3:4-8 (11-13:14-18)	1CT:1CT	1-3 (11-13)	3.5	(1-3 & 11-13)	≤20%	±1V	≥45dB	75kHz to 1MHz	10K @ 250Vdc	100Vrms
	1-3:5-7 (11-13:15-17)	1.4CT:1CT	4-8 (14-18)	3.5	4,000						
SLQT1553-2	1-3:4-8 (11-13:14-18)	1.4CT:1CT	1-3 (11-13)	3.5	(1-3 & 11-13)	≤20%	±1V	≥45dB	75kHz to 1MHz	10K @ 250Vdc	100Vrms
	1-3:5-7 (11-13:15-17)	2CT:1CT	4-8 (14-18)	3.2	7,200						
SLQT1553-3	1-3:4-8 (11-13:14-18)	1.25CT:1CT	1-3 (11-13)	3.2	(1-3 & 11-13)	≤20%	±1V	≥45dB	75kHz to 1MHz	10K @ 250Vdc	100Vrms
	1-3:5-7 (11-13:15-17)	1.66CT:1CT	4-8 (14-18)	3.0	4,000						
SLQT1553-5	1-3:4-8 (11-13:14-18)	1CT:2.12CT	1-3 (11-13)	1.0	(4-8 & 14-18)	≤20%	±1V	≥45dB	75kHz to 1MHz	10K @ 250Vdc	100Vrms
	1-3:5-7 (11-13:15-17)	1CT:1.5CT	4-8 (14-18)	3.5	4,000						
SLQT1553-45	1-3:4-8 (11-13:14-18)	1CT:2.5CT	1-3 (11-13)	1.0	(4-8 & 14-18)	≤20%	±1V	≥45dB	75kHz to 1MHz	10K @ 250Vdc	100Vrms
	1-3:5-7 (11-13:15-17)	1CT:1.79CT	4-8 (14-18)	3.5	4,000						
FLAT PACK											
SLQF1553-1	1-3:4-8 (11-13:14-18)	1CT:1CT	1-3 (11-13)	3.5	(1-3 & 11-13)	≤20%	±1V	≥45dB	75kHz to 1MHz	10K @ 250Vdc	100Vrms
	1-3:5-7 (11-13:15-17)	1.4CT:1CT	4-8 (14-18)	3.5	4,000						
SLQF1553-2	1-3:4-8 (11-13:14-18)	1.4CT:1CT	1-3 (11-13)	3.5	(1-3 & 11-13)	≤20%	±1V	≥45dB	75kHz to 1MHz	10K @ 250Vdc	100Vrms
	1-3:5-7 (11-13:15-17)	2CT:1CT	4-8 (14-18)	3.2	7,200						
SLQF1553-3	1-3:4-8 (11-13:14-18)	1.25CT:1CT	1-3 (11-13)	3.2	(1-3 & 11-13)	≤20%	±1V	≥45dB	75kHz to 1MHz	10K @ 250Vdc	100Vrms
	1-3:5-7 (11-13:15-17)	1.66CT:1CT	4-8 (14-18)	3.0	4,000						
SLQF1553-5	1-3:4-8 (11-13:14-18)	1CT:2.12CT	1-3 (11-13)	1.0	(4-8 & 14-18)	≤20%	±1V	≥45dB	75kHz to 1MHz	10K @ 250Vdc	100Vrms
	1-3:5-7 (11-13:15-17)	1CT:1.5CT	4-8 (14-18)	3.5	4,000						
SLQF1553-45	1-3:4-8 (11-13:14-18)	1CT:2.5CT	1-3 (11-13)	1.0	(4-8 & 14-18)	≤20%	±1V	≥45dB	75kHz to 1MHz	10K @ 250Vdc	100Vrms
	1-3:5-7 (11-13:15-17)	1CT:1.79CT	4-8 (14-18)	3.5	4,000						
GULL WING											
SLQG1553-1	1-3:4-8 (11-13:14-18)	1CT:1CT	1-3 (11-13)	3.5	(1-3 & 11-13)	≤20%	±1V	≥45dB	75kHz to 1MHz	10K @ 250Vdc	100Vrms
	1-3:5-7 (11-13:15-17)	1.4CT:1CT	4-8 (14-18)	3.5	4,000						
SLQG1553-2	1-3:4-8 (11-13:14-18)	1.4CT:1CT	1-3 (11-13)	3.5	(1-3 & 11-13)	≤20%	±1V	≥45dB	75kHz to 1MHz	10K @ 250Vdc	100Vrms
	1-3:5-7 (11-13:15-17)	2CT:1CT	4-8 (14-18)	3.2	7,200						
SLQG1553-3	1-3:4-8 (11-13:14-18)	1.25CT:1CT	1-3 (11-13)	3.2	(1-3 & 11-13)	≤20%	±1V	≥45dB	75kHz to 1MHz	10K @ 250Vdc	100Vrms
	1-3:5-7 (11-13:15-17)	1.66CT:1CT	4-8 (14-18)	3.0	4,000						
SLQG1553-5	1-3:4-8 (11-13:14-18)	1CT:2.12CT	1-3 (11-13)	1.0	(4-8 & 14-18)	≤20%	±1V	≥45dB	75kHz to 1MHz	10K @ 250Vdc	100Vrms
	1-3:5-7 (11-13:15-17)	1CT:1.5CT	4-8 (14-18)	3.5	4,000						
SLQG1553-45	1-3:4-8 (11-13:14-18)	1CT:2.5CT	1-3 (11-13)	1.0	(4-8 & 14-18)	≤20%	±1V	≥45dB	75kHz to 1MHz	10K @ 250Vdc	100Vrms
	1-3:5-7 (11-13:15-17)	1CT:1.79CT	4-8 (14-18)	3.5	4,000						

NOTE: IPC/JDEC J-STD-020A Moisture Sensitivity – Through Hole: Level 1 – Surface Mount: Level 3

MIL-STD-1553 TRANSFORMERS

Low Profile / Stacked Dual THT and SMT non-QPL Interface Transformers



Mechanical

Schematic

Flat Pack

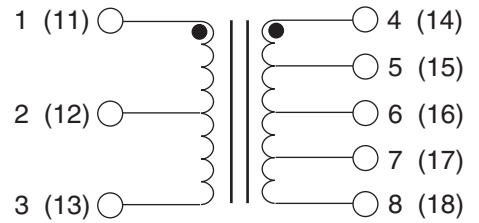
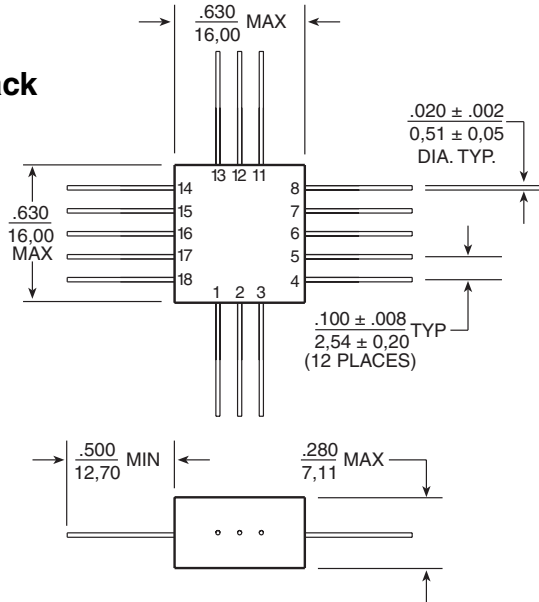

Dimensions: Inches
mm
 Unless otherwise specified,
 all tolerances are ± .010
0,25

Through-Hole

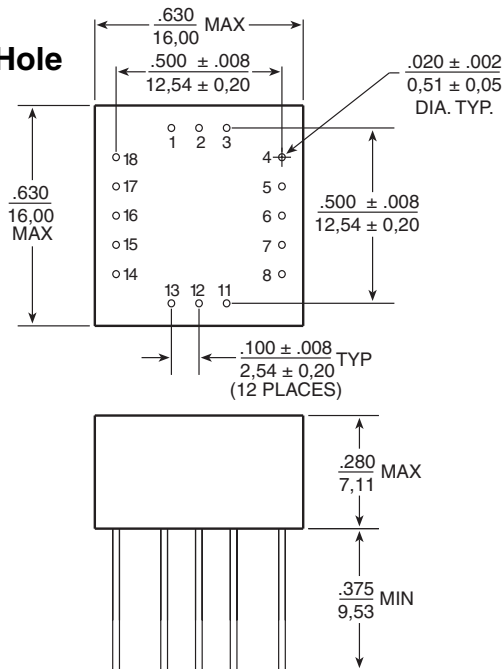

Surface Mount

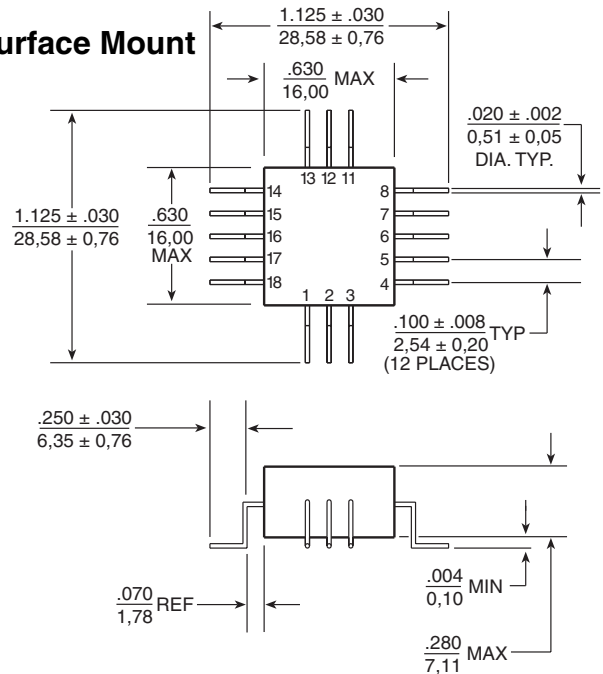

WARRANTY

Pulse Military Aerospace Division warrants for a period of 90 days from the date of shipment, that under normal use and service, its products will be free from defects in workmanship and material. Pulse Military Aerospace Division's sole responsibility under this warranty is, at its option, to repair or replace, without charge, any defective product or part, or to credit buyer for the purchase price of such defective product, provided:

- 1) Buyer promptly notifies Pulse Military Aerospace Division in writing within the warranty period, and
- 2) The defective product or part is returned to Pulse Military Aerospace Division with transportation charges prepaid by Buyer, and
- 3) Pulse Military Aerospace Division's examination of such product shall disclose to its satisfaction that said defect exists and has not been caused by misuse, neglect, improper installation, repair or alteration, or accident.

EXCEPT FOR THE ABOVE WARRANTY AND THE IMPLIED WARRANTY OF TITLE, PULSE MILITARY AEROSPACE DIVISION MAKES NO OTHER WARRANTIES, EXPRESS OR IMPLIED, INCLUDING ANY IMPLIED WARRANTY OF MERCHANTABILITY OR FITNESS FOR ANY PARTICULAR PURPOSE. NO LIABILITY IS ASSUMED FOR EXPENDABLE ITEMS SUCH AS LAMPS AND FUSES. PULSE MILITARY AEROSPACE DIVISION WILL NOT BE LIABLE FOR INCIDENTAL OR CONSEQUENTIAL DAMAGES UNDER ANY CIRCUMSTANCES.

MIL-STD-1553 TRANSFORMERS



MIL-STD-1553 TRANSFORMERS



For More Information:

Pulse Worldwide Headquarters

12220 World Trade Dr.
San Diego, CA 92128
U.S.A.

www.pulseeng.com

Tel: 858 674 8100

Fax: 858 674 8262

Pulse Europe

Einsteinstrasse 1
D-71083 Herrenberg
Germany

Tel: 49 7032 7806 0

Fax: 49 7032 7806 12

Pulse China Headquarters

B402, Shenzhen Academy of
Aerospace Technology Building
10th Kejinan Rd.
High-Tech Zone
Nanshan District, Shenzhen
P.R. China 518057

Tel: 86 755 33966678

Fax: 86 755 33966700

Pulse North China

Room 1503
XinYin Building
No. 888 YiShan Rd.
Shanghai 200233
China

Tel: 86 21 32181071

Fax: 86 21 32181396

Pulse South Asia

150 Kampong Ampat
#07-01/02
KA Centre
Singapore 368324

Tel: 65 6287 8998

Fax: 65 6280 0080

Pulse North Asia

No. 26
Kao Ching Rd.
Yang Mei Chen
Taoyuan Hsien
Taiwan, R. O. C.
32667

Tel: 886 3 4643715

Fax: 886 3 4641911

Performance warranty of products offered on this data sheet is limited to the parameters specified. Data is subject to change without notice. Other brand and product names mentioned herein may be trademarks or registered trademarks of their respective owners. © Copyright, 2008. Pulse Engineering, Inc. All rights reserved.

www.pulseeng.com

MC118 (1/08)