

TABLE of CONTENTS

01 - Mini-Line EE20 - 0.08VA-0.5VA	
EE20 / 4 - 0.08VA	2
EE20 / 6.1 - 0.35VA	3
EE20 / 10 - 0.50VA	4
02 - Print-Line EI30 - 0.5VA-2.8 VA	
EI30 / 5 - 0.5VA	5
EI30 / 10.5 - 1VA	6
EI30 / 12.5 - 1.2VA	7
EI30 / 12.5 - 1.5VA	8
EI30 / 15.5 - 2VA	9
EI30 / 18 - 2.3VA	10
EI30 / 23 - 2.8VA	11
03 - Print-Line EI38 - 3.2VA-4VA	
EI38 / 13.6 - 3.2VA	12
EI38 / 13.6 - 4VA	13
04 - Print-Line EI42-EI54 - 5VA-16VA	
EI42 / 14.8 - 5VA	14
EI48 / 16.8 - 10VA	15
EI54 / 18.8 - 16VA	16
05 - Transformers with mounting brackets - 5VA-16VA	
EI42 / 14.8 - 5VA	17
EI48 / 16.8 - 10VA	18
EI54 / 18.8 - 16VA	19
06 - Low Profile Transformers - 2VA-10VA	
UI30 / 5.5 - 2VA	20
UI30 / 7.5 - 4VA	21
UI30 / 10.5 - 6VA	22
UI30 / 16.5 - 10VA	23
07 - Compact Power Supplies	
EI48 / 16.8 (AC)	24
EI48 / 16.8 (DC)	24
08 - Low Frequency Open-Style Laminated Transformers	
Low Profile Plug-In Series	25
Chassis-Tran Series	26
International PC Plug-In Series	27
International High Power Series	28
Split Bobbin, Horizontal Plug-In Series	29
Concentric Vertical Profile PC Plug-In Series	30
Parts Index	31-32

LAMINATED TRANSFORMERS OVERVIEW



With the addition of **era**'s encapsulated 50/60Hz transformers to the existing line of Pulse open frame transformers, Pulse now offers a complete line of laminated transformers for all your low power, linear transformer needs. With power ratings from 0.08VA to 175VA, fully encapsulated transformers, split bobbin designs, and a wide variety of domestic and international agency approvals, Pulse is truly the one stop shop for all your 50/60Hz needs.

Advantages of Encapsulated Transformers:

- Better heat dissipation achieved through vacuum encapsulation, resulting in more output power from a smaller, more compact design.
- Vacuum encapsulation provides protection against external influences (e.g. wash operations) and mechanical stress (e.g. vibration). It also reduces the potential of noise through vibration.
- Dimensional accuracy of each transformer guaranteed by stable and controlled manufacturing processes, allowing for automatic pick and place operations.

This catalog serves as an overview for the Pulse Laminated Transformer product line. Please contact Pulse Power Applications Engineering for more information. For Pulse's complete line of Power Inductors, Transformers, Chokes and Current Sense Magnetics, please see the Switching Power Magnetics catalog.

NOTE: For additional listings of Pulse Power magnetics, see other Power data sheets at this URL: <http://www.pulseeng.com/products/dataSheets.aspx>

OVERVIEW: LAMINATED TRANSFORMERS



Mini-Line THT* (EE20)

- Up to 0.5VA
- Temperature class t_a 70°C/B



Print-Line THT* (EI30-EI54)

- Up to 16VA
- Temperature class t_a 70°C/B (EI 30 / EI 42)
- Temperature class t_a 40°C/B (EI 48 / EI 54)



Low Profile THT* (UI30)

- Up to 10VA
- Temperature class t_a 40°C/B

With Mounting Brackets* (EI42-EI54)

- Up to 16VA
- Temperature class t_a 70°C/B (EI 42)
- Temperature class t_a 40°C/B (EI 48 / EI 54)



Compact Power Supplies

- Vdc or Vac secondary
- Temperature class t_a 40°C/B
- Din-rail Mounting

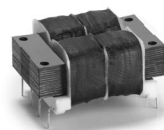

Printed Circuit Mount

- International
- Split bobbin: single (ST) and dual primary (DST)
- Low profile
- Concentric vertical profile single (PC) and dual primary (DPC)



Chassis Mount

- International
- Split bobbin: single (241) and dual primary (DP241)

*Potted under vacuum, two-chamber bobbin, custom designs available upon request, THT = Through Hole.

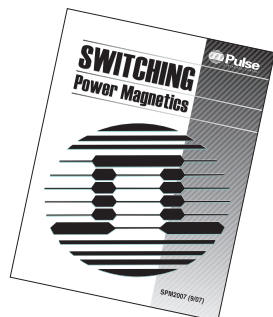

For all other Pulse Inductors and Transformers, check out Pulse's SWITCHING POWER MAGNETICS catalog. To order, see our website:

www.pulseeng.com

Go to Products/Literature Request and ask for **SPM2007** catalog

LAMINATED TRANSFORMERS



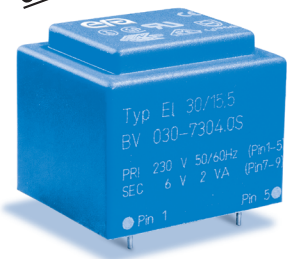



Type EI30 / 15.5 - 2.0VA



AGENCY APPROVALS 

1. UL 506, File E113449 

3. EN61558 

-  Frequency 50/60Hz
-  Potted under vacuum
-  Split-bobbin
-  Temperature class ta 70°C/B
-  VDE rated as inherently short-circuit proof
-  Weight: 0.10kg
-  Packaging unit: 25 pieces (tube)

Mechanical

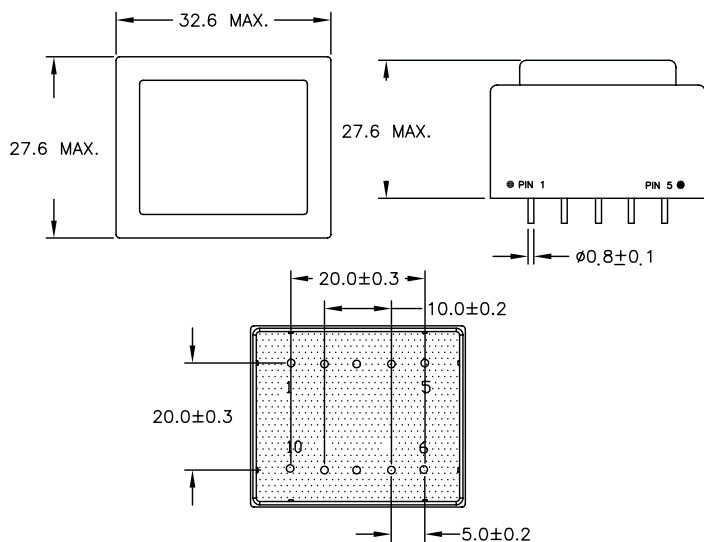

Primary (V)	Secondary (V / mA)	No-Load Voltage (V)	Schematic No.	Part Number	Agency Approvals
230	6 / 333	10.50	1	030-7304.0	1/3*
230	9 / 222	14.60	1	030-7305.0	1/3*
230	12 / 166	20.00	1	030-7306.0	1/3*
230	15 / 133	26.00	1	030-7307.0	1/3*
230	18 / 111	29.60	1	030-7308.0	1/3*
230	24 / 83	37.20	1	030-7309.0	1/3*
230	2x6 / 166	2x8.70	2	030-7310.0	1/3*
230	2x9 / 111	2x14.60	2	030-7311.0	1/3*
230	2x12 / 83	2x19.45	2	030-7312.0	1/3*
230	2x15 / 66	2x24.10	2	030-7313.0	1/3*
230	2x18 / 55	2x29.10	2	030-7314.0	1
230	2x24 / 42	2x36.50	2	030-7315.0	1
115	6 / 333	10.50	1	030-7292.0	1/3*
115	9 / 222	14.60	1	030-7293.0	1/3*
115	12 / 166	20.00	1	030-7294.0	1/3*
115	2x6 / 166	2x8.70	2	030-7298.0	1/3*
115	2x9 / 111	2x14.60	2	030-7299.0	1/3*
115	2x12 / 83	2x19.45	2	030-7300.0	1/3*
2x115	6 / 333	10.50	3	030-6429.0	1/3*
2x115	9 / 222	14.60	3	030-6432.0	1/3*
2x115	15 / 133	26.00	3	030-6438.0	1/3*
2x115	18 / 111	29.60	3	030-6441.0	1/3*
2x115	2x9 / 111	2x14.60	4	030-6455.0	1/3*
2x115	2x12 / 83	2x19.45	4	030-6458.0	1/3*
2x115	2x15 / 66	2x24.10	4	030-6461.0	1/3*

*NOTE: When checking the approval status of this product with VDE, add the prefix "BV" and the suffix "S" to the orderable Part Number (these letters will also be found on the part label). The prefix and suffix are **not** part of the orderable Part Number.

Schematic

