

COMPACT FLASH CARD CONNECTORS

560H SERIES (CFA COMPATIBLE)

■ FEATURES

- The connectors conform to the Compact Flash Association (CFA) specifications.
- The terminal of the plug is a 0.635 mm pitch, one-row, SMT type.
- Raised mounting type connectors (standoff), which allow mounting components under a connector, are also available.
- The ejector mechanism makes insertion and ejection of a card easier is available.
- There are two types of sockets for CFA cards: a straddle mount type and single-sided mounting type.

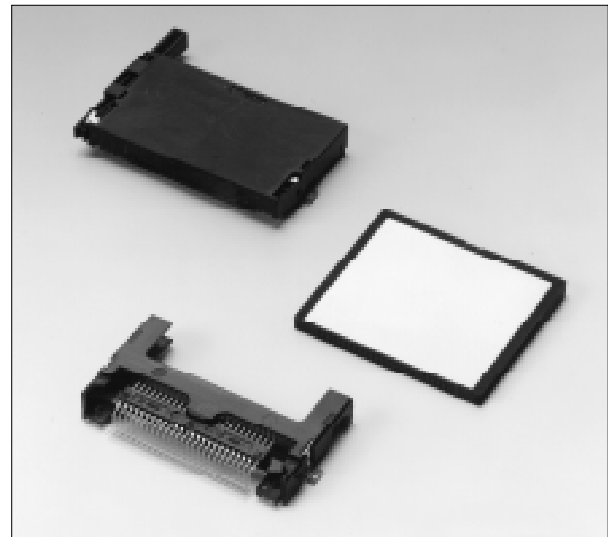

■ SPECIFICATIONS

Item	Specification
Operating temperature range	-55° to +85 ° C
Rated current	0.5A DC
Rated voltage	250V AC
Contact resistance	80mΩ max (DC 20mV, 10mA)
Insulation resistance	1000MΩ min., 500V DC,
Dielectric withstand voltage	500V DC

■ PIN CONNECTOR (PLUG) CONTACT LENGTH

Contact Type	Pin no.	Contact length
Power, ground pins	1, 13, 38, 50	4.98 mm (0.196 in.)
Card dection pins	25, 26	3.48 mm (0.137 in.)
Other signal pins	Other	4.24 mm (0.167 in.)

■ MATERIALS

Item	Material
Insulating material	Main body: PPS resin UL94V-0 Guide: PBT UL94V-0 Button: ABS UL94V-0
Conductor	Copper alloy
Plating	Contact: gold Terminal: palladium

560H Series (Compact Flash Connector)

RIGHT ANGLE PLUG, SMT TYPE (WITH NO EJECTOR)

DIMENSIONS

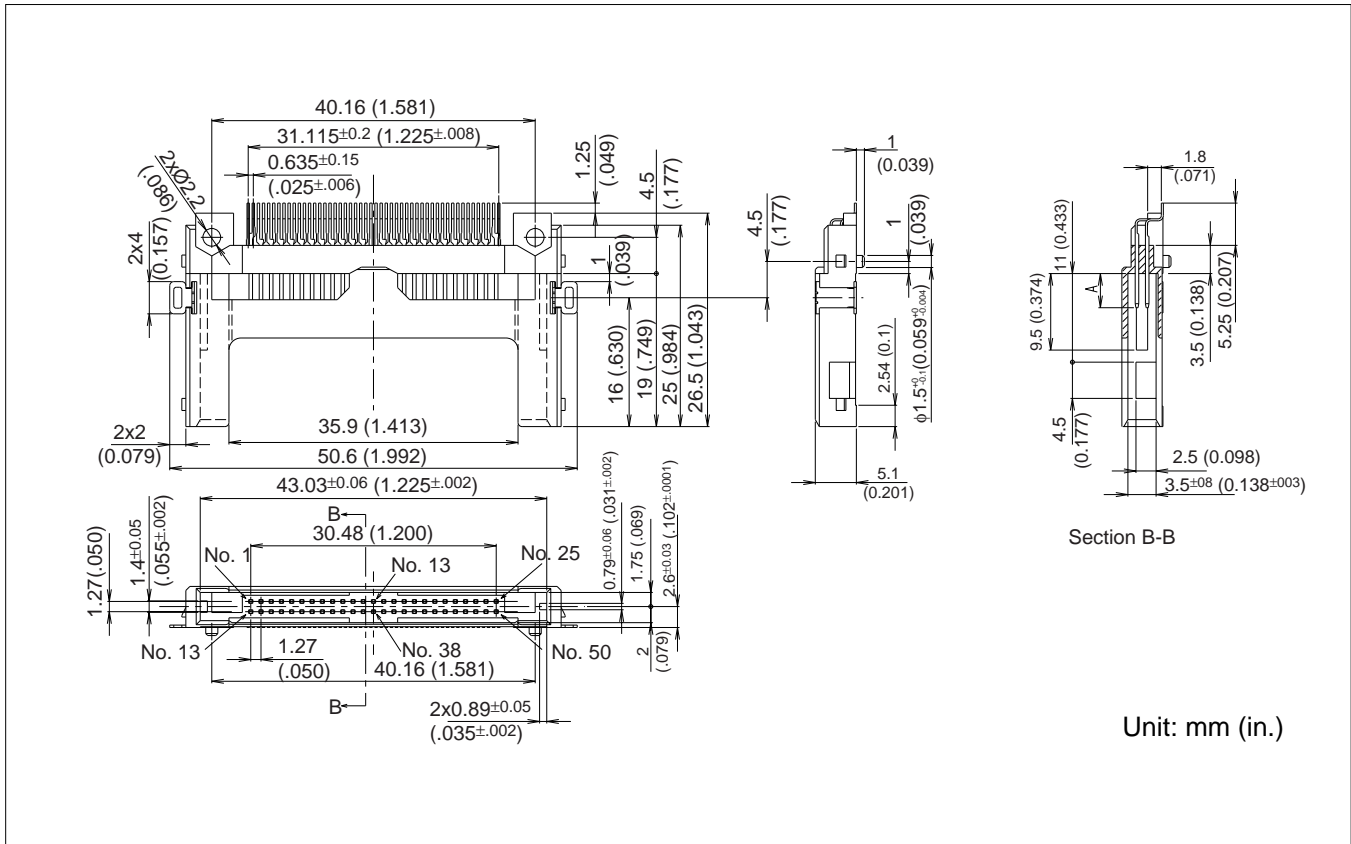

PC BOARD MOUNTING PATTERN (MOUNTING SIDE)

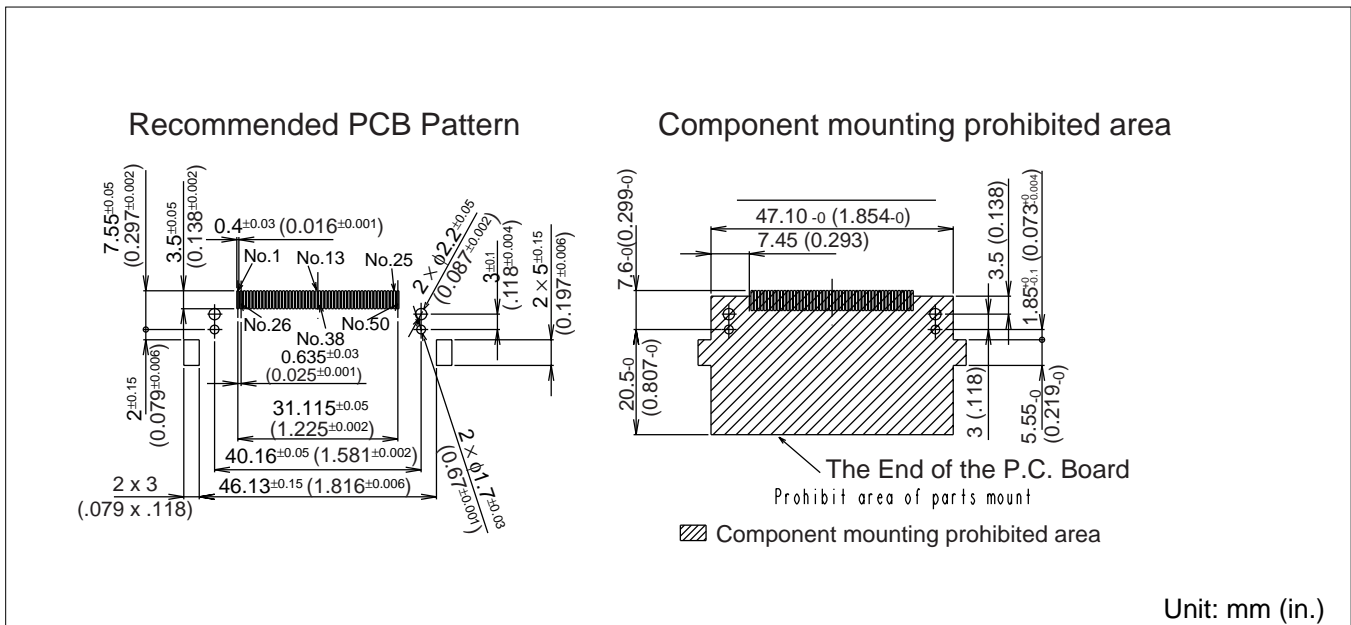

ORDERING PART NUMBER

FCN-568H050-G/A1

For above connector with ejector mechanism see page 3.

560H Series (Compact Flash Connector)

RIGHT ANGLE PLUG, SMT TYPE (WITH EJECTOR)

■ DIMENSIONS

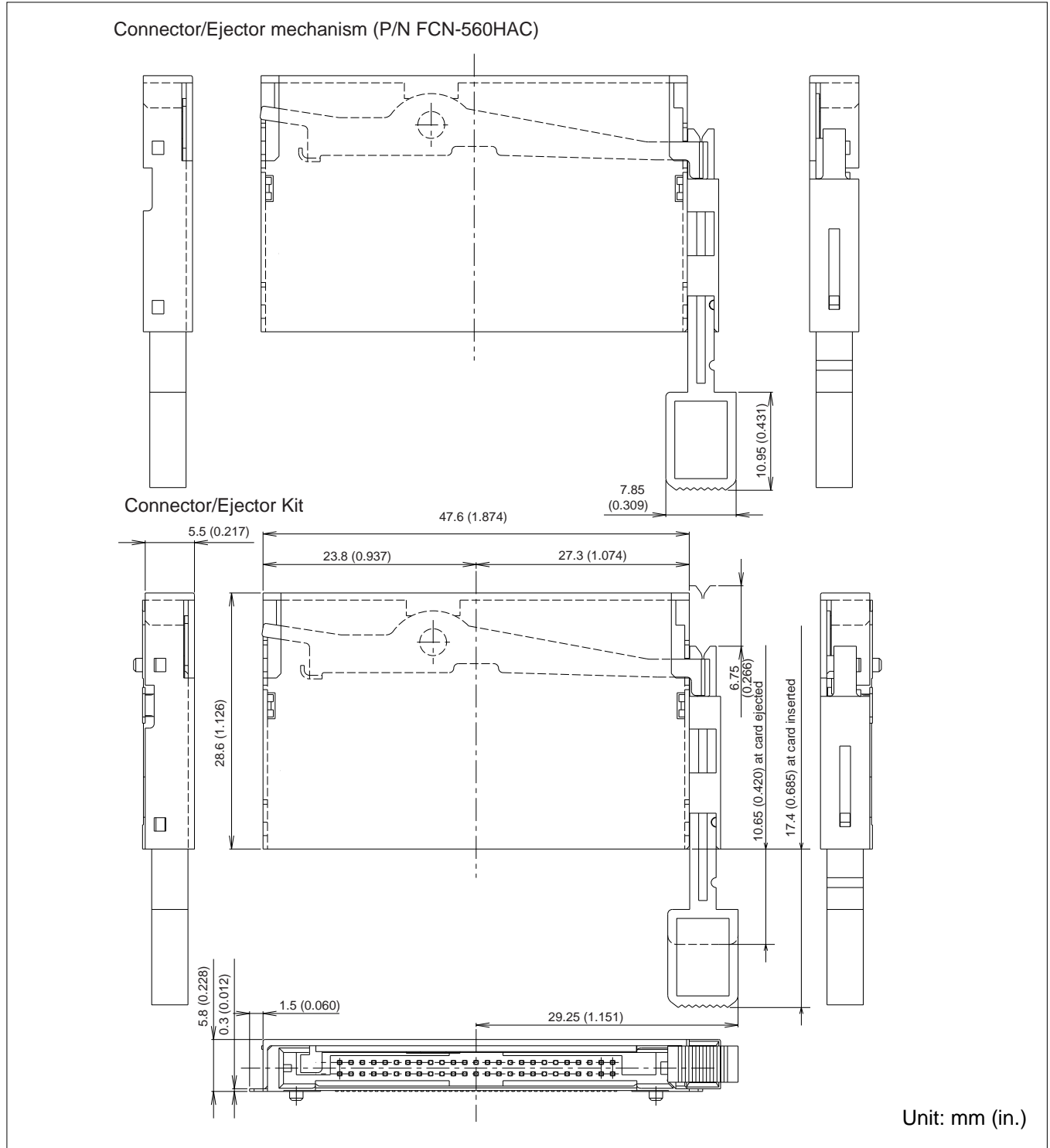

■ ORDERING PART NUMBER FOR CONNECTOR/EJECTOR KIT

FCN-568H050-G/A1AC

560H Series (Compact Flash Connector)

RIGHT ANGLE PLUG, SMT TYPE (WITH NO EJECTOR, TO BE MOUNTED ON BACK OF PC BOARD)

DIMENSIONS

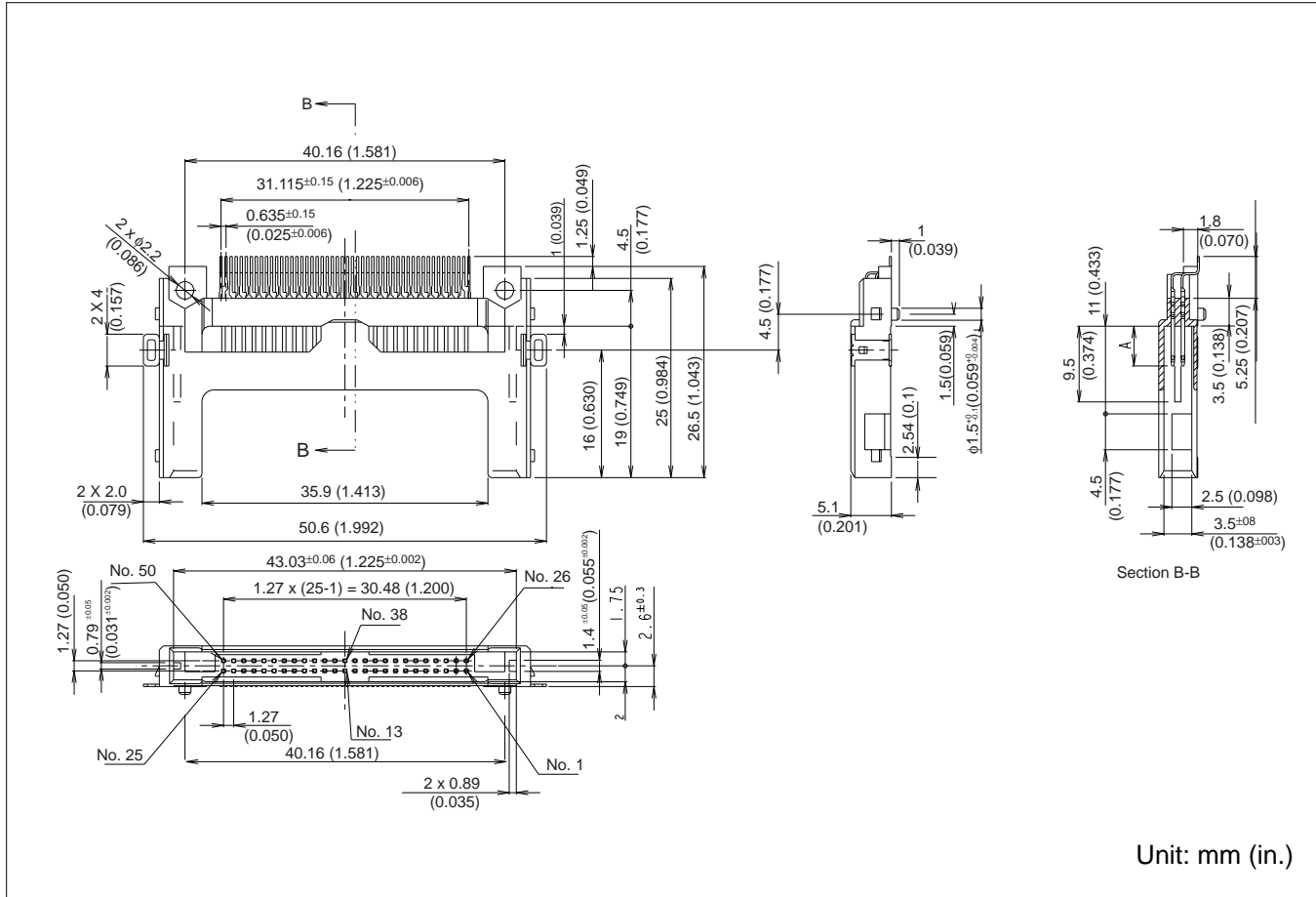

PC BOARD MOUNTING PATTERN (MOUNTING SIDE)

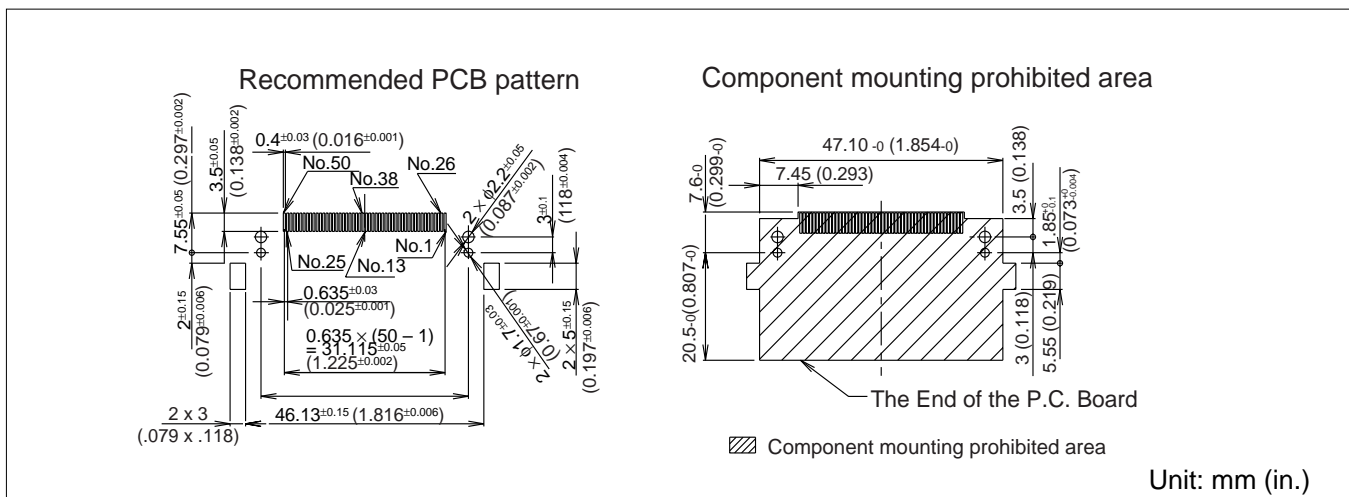

ORDERING PART NUMBER

FCN-568H050-G/A2

For above connector with ejector mechanism see page 5.

560H Series (Compact Flash Connector)

RIGHT ANGLE PLUG, SMT TYPE (WITH EJECTOR, TO BE MOUNTED ON BACK OF PC BOARD)

■ DIMENSIONS

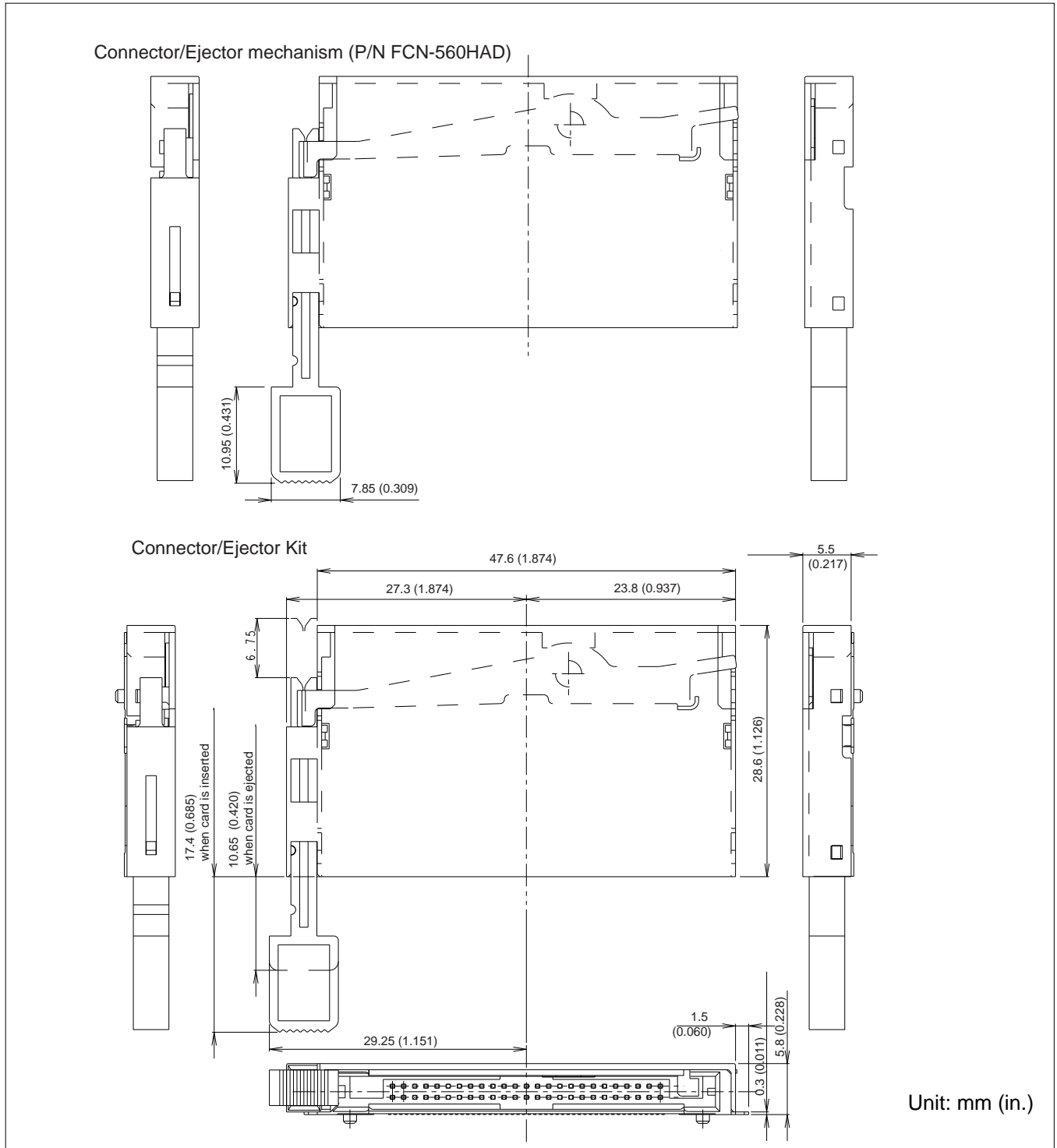

■ ORDERING PART NUMBER FOR CONNECTOR/EJECTOR KIT

FCN-568H050-G/A2AD

560H Series (Compact Flash Connector)

RIGHT-ANGLE PLUG, SMT TYPE (WITH NO EJECTOR, 1.64mm RAISED TYPE)

■ DIMENSIONS

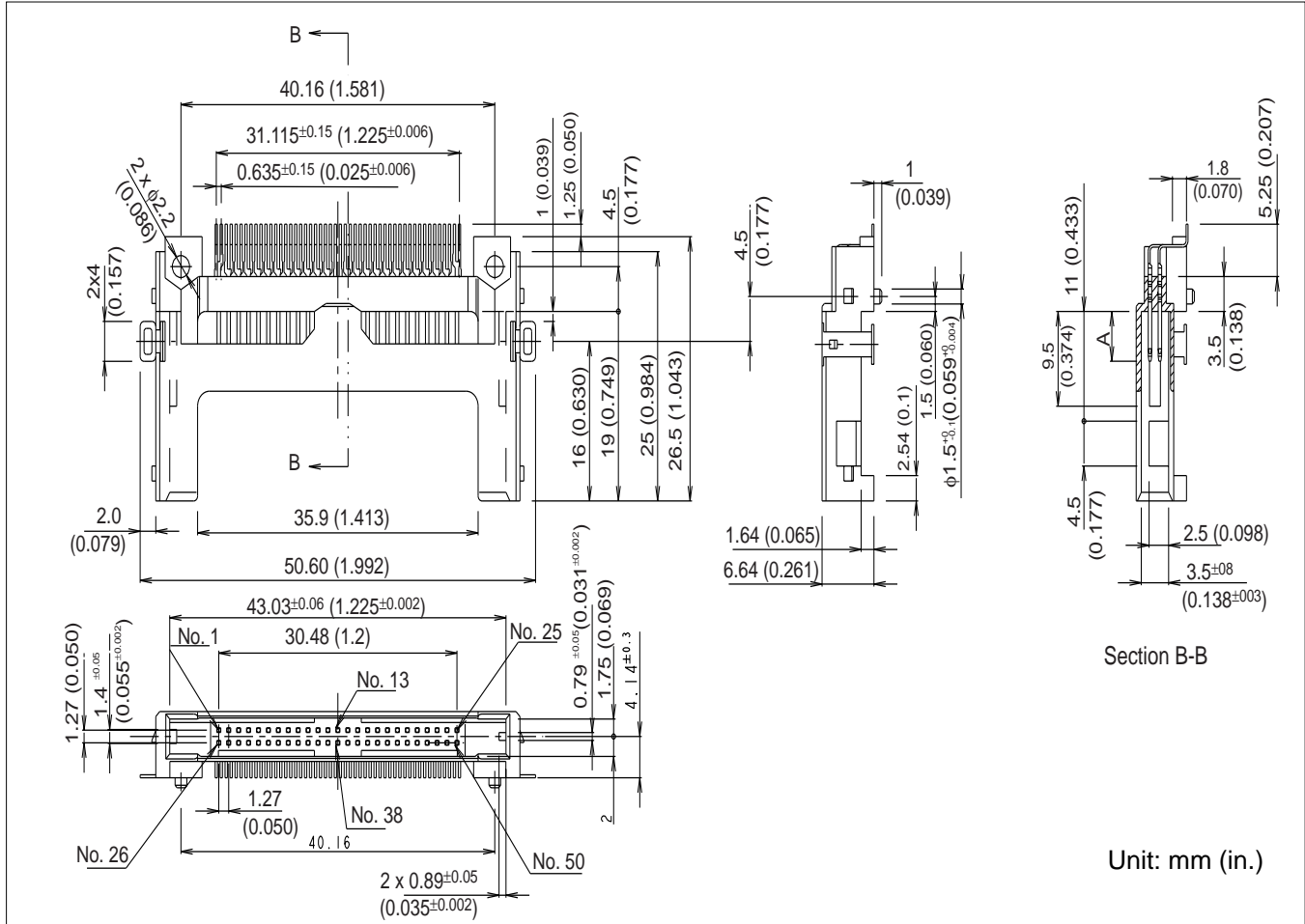

■ PC BOARD MOUNTING PATTERN (MOUNTING SIDE)

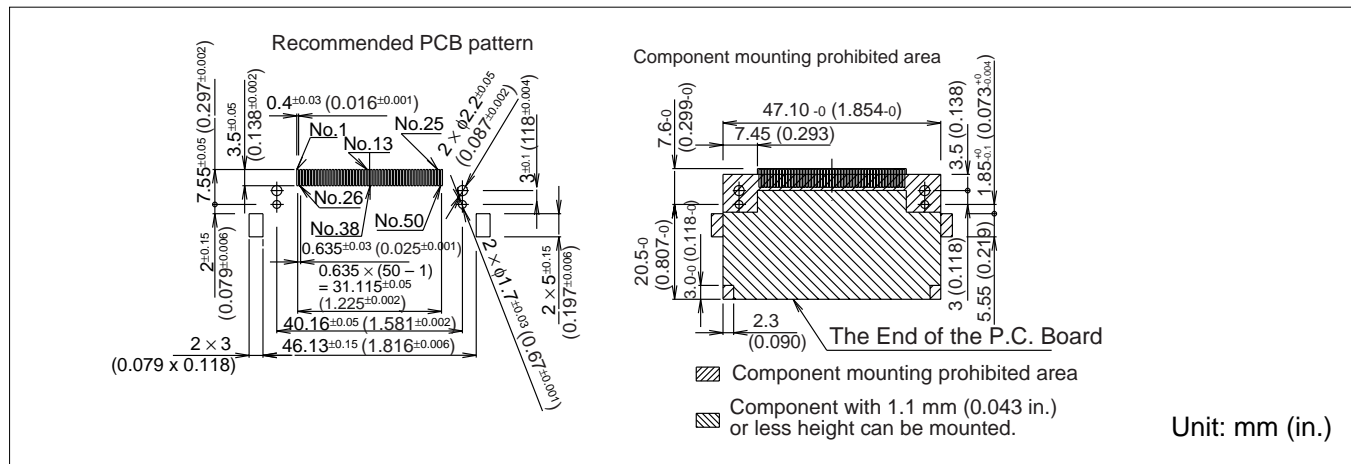

■ ORDERING PART NUMBER

FCN-568H050-G/A3

For above connector with ejector mechanism see page 7.

560H Series (Compact Flash Connector)

RIGHT-ANGLE PLUG, SMT TYPE (WITH EJECTOR, 1.64mm (0.065 in.) RAISED TYPE)

■ DIMENSIONS

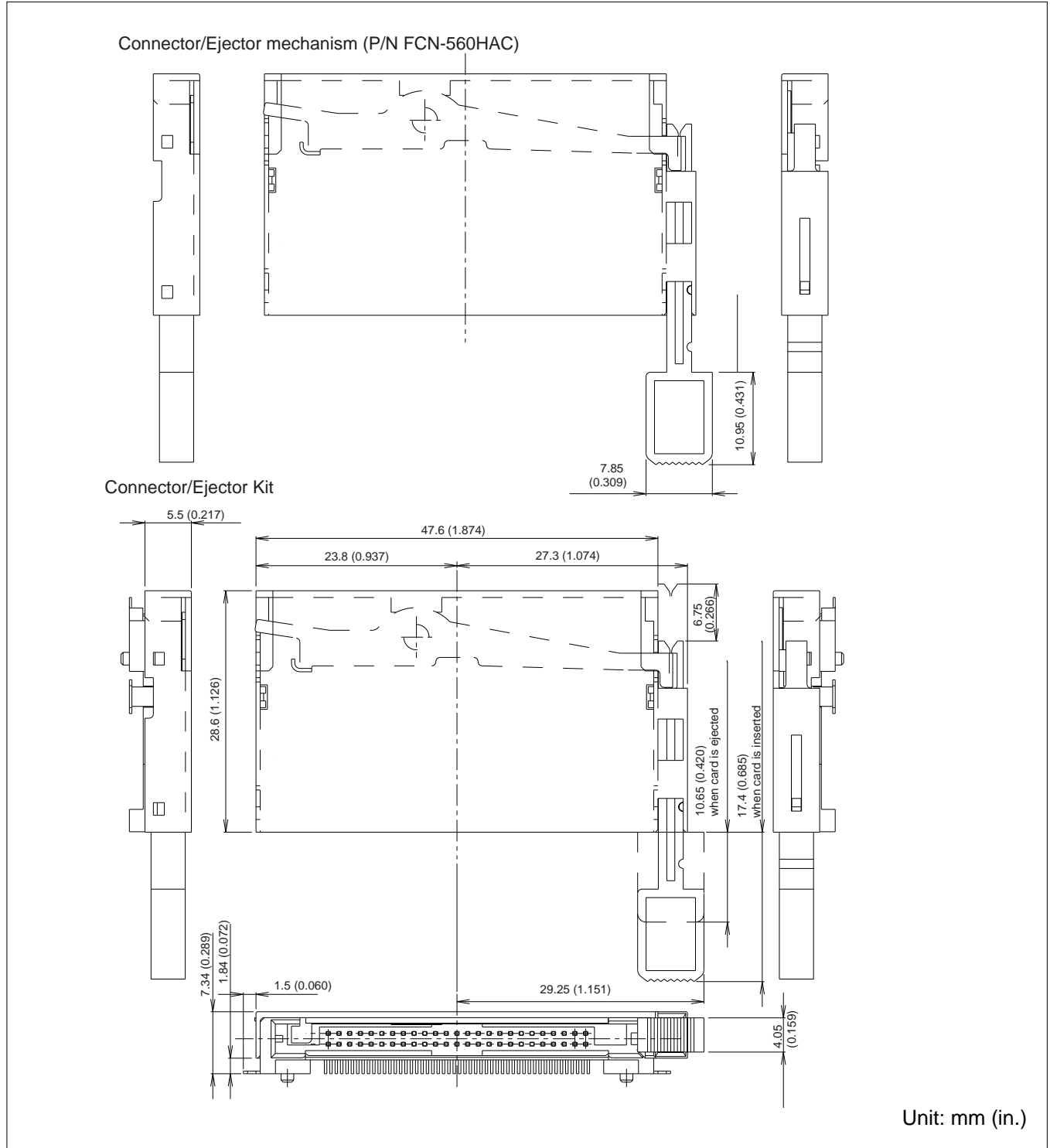

■ ORDERING PART NUMBER FOR CONNECTOR/EJECTOR KIT

FCN-568H050-G/A3AC

560H Series (Compact Flash Connector)

RIGHT-ANGLE PLUG, SMT TYPE (WITH NO EJECTOR, 1.64mm (0.065) RAISED TYPE, TO BE MOUNTED ON BACK OF PC BOARD)

DIMENSIONS

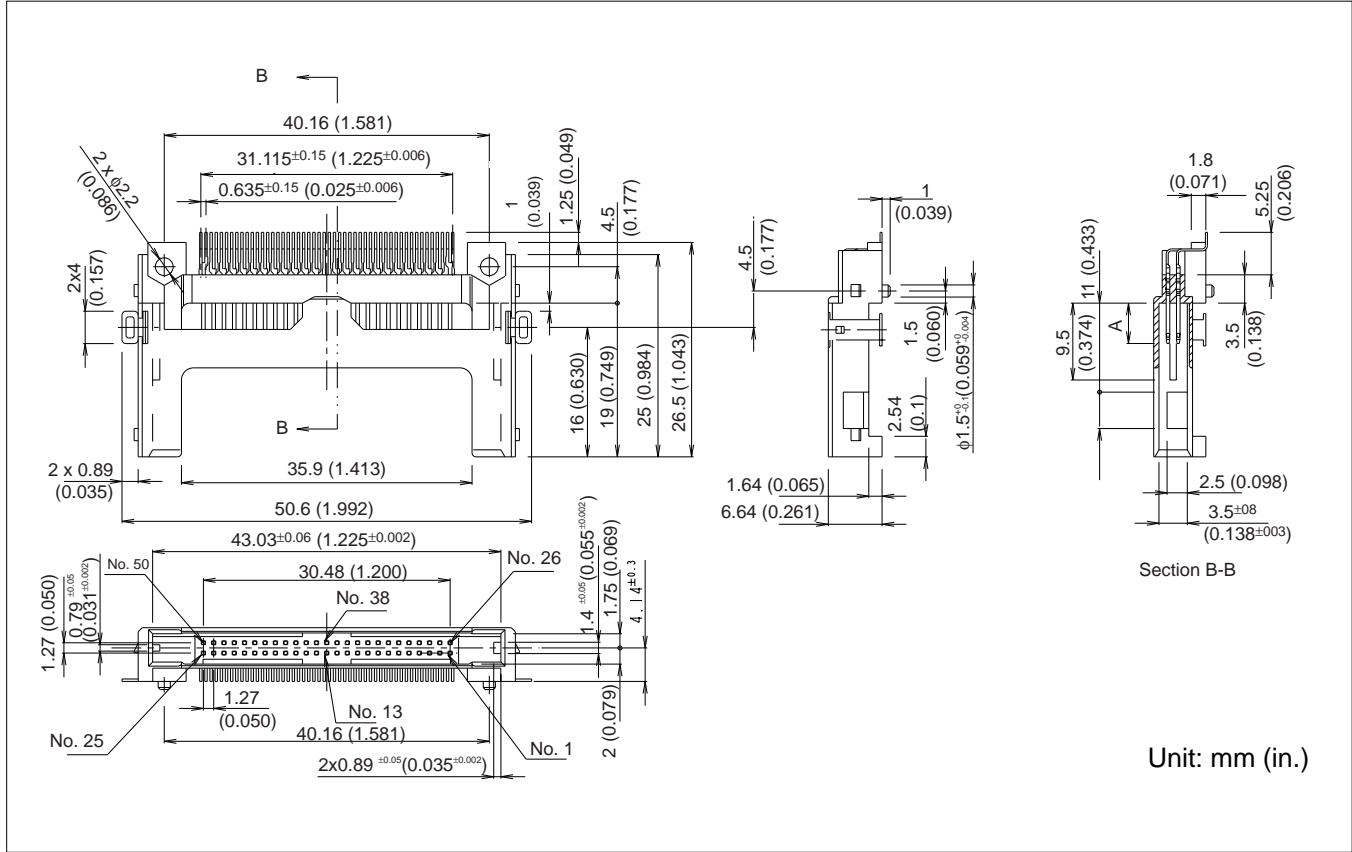

PC BOARD MOUNTING PATTERN (MOUNTING SIDE)

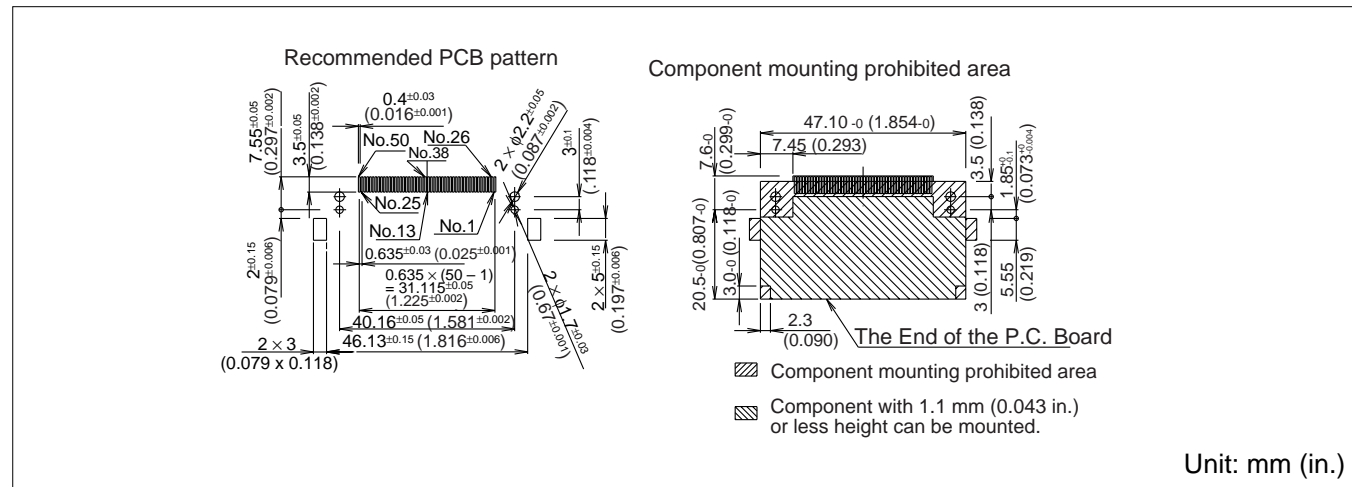

ORDERING PART NUMBER

FCN-568H050-G/A4

For above connector with ejector mechanism see page 9.

560H Series (Compact Flash Connector)

RIGHT-ANGLE PLUG, SMT TYPE (WITH EJECTOR, 1.64mm (0.065 in.) RAISED TYPE, TO BE MOUNTED ON BACK OF PC BOARD)

■ DIMENSIONS

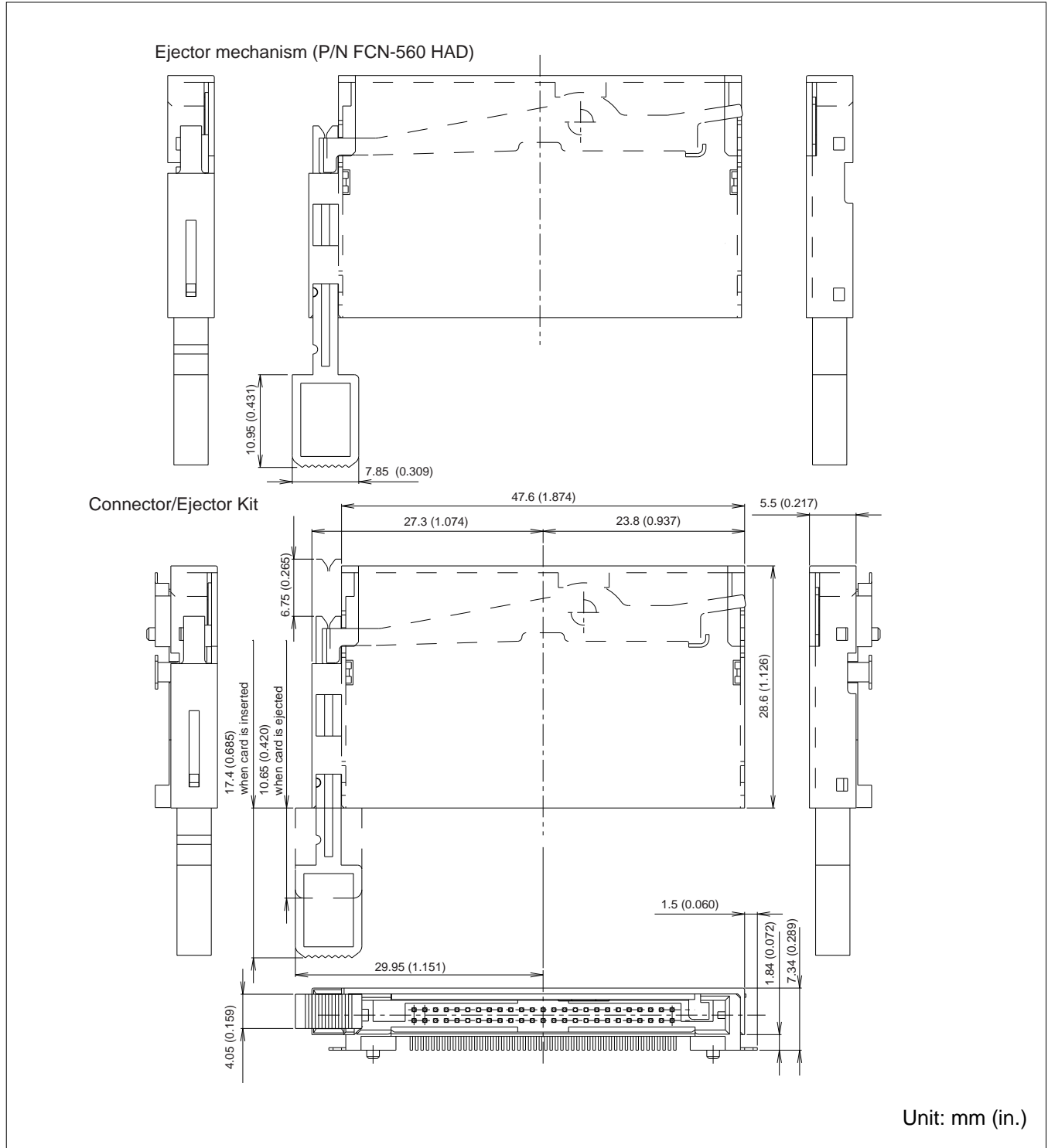

■ ORDERING PART NUMBER

FCN-568H050-G/A4AD

560H Series (Compact Flash Connector)

FCN-560H Series Connector PLUG (Guide)

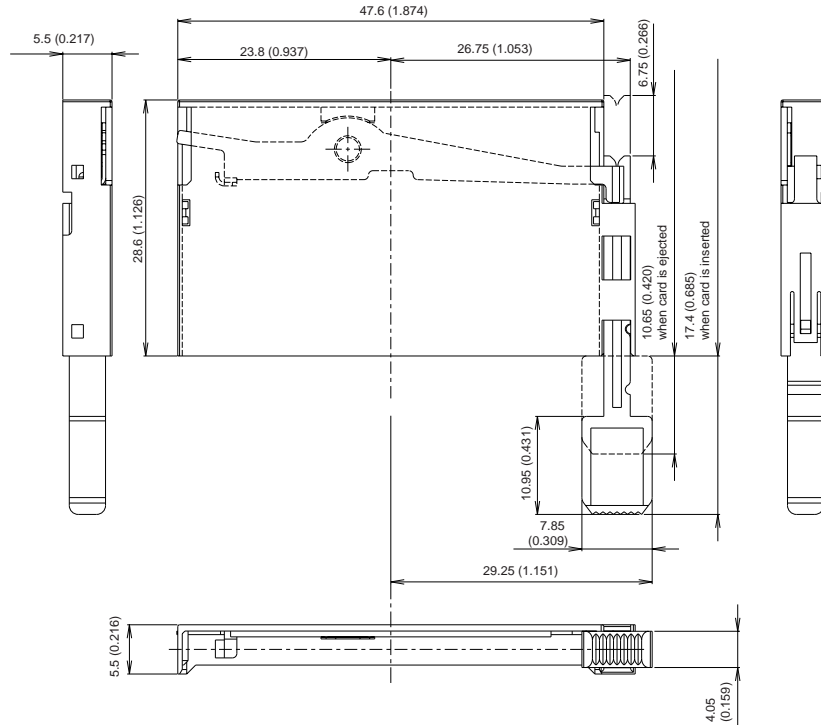

Part No: FCN-560HAC

FCN-560 Series Connector PLUG (GUIDE)

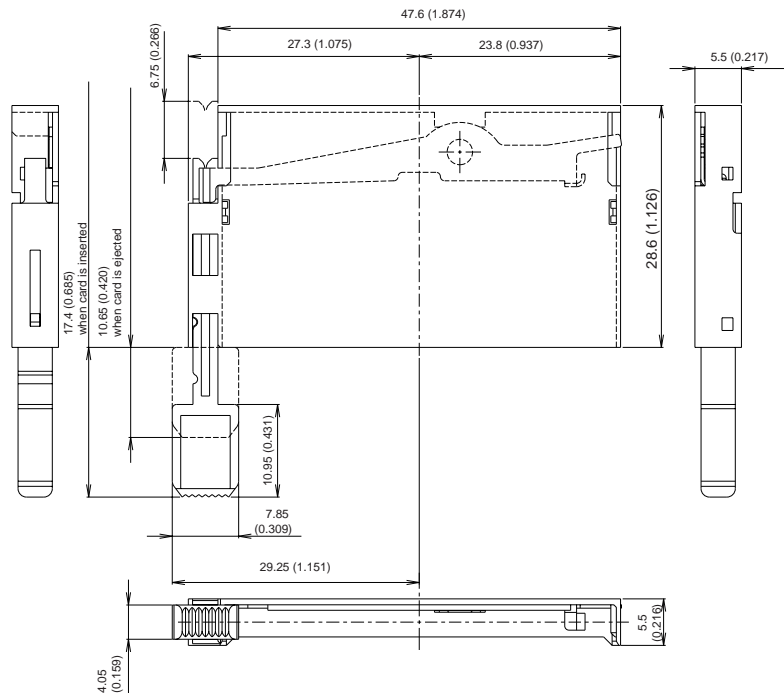

Part No: FCN-560HAD

560H Series (Compact Flash Connector)

Fujitsu Components International Headquarter Offices

Japan

Fujitsu Component Limited
Gotanda-Chuo Building
3-5, Higashigotanda 2-chome, Shinagawa-ku
Tokyo 141, Japan
Tel: (81-3) 5449-7010
Fax: (81-3) 5449-2626
Email: promothq@ft.ed.fujitsu.com
Web: www.fcl.fujitsu.com

North and South America

Fujitsu Components America, Inc.
250 E. Caribbean Drive
Sunnyvale, CA 94089 U.S.A.
Tel: (1-408) 745-4900
Fax: (1-408) 745-4970
Email: marcom@fcai.fujitsu.com
Web: www.fcai.fujitsu.com

Europe

Fujitsu Components Europe B.V.
Diamantlaan 25
2132 WV Hoofddorp
Netherlands
Tel: (31-23) 5560910
Fax: (31-23) 5560950
Email: info.marketing@fceu.fujitsu.com
Web: www.fceu.fujitsu.com

Asia Pacific

Fujitsu Components Asia Ltd.
102E Pasir Panjang Road
#04-01 Citilink Warehouse Complex
Singapore 118529
Tel: (65) 375-8560
Fax: (65) 273-3021
Email: fcal@fcal.fujitsu.com
www.fcal.fujitsu.com

© 2001 Fujitsu Components America, Inc. All company and product names are trademarks or registered trademarks of their respective owners. Rev. 09/2001