

### 3130/3134/3151

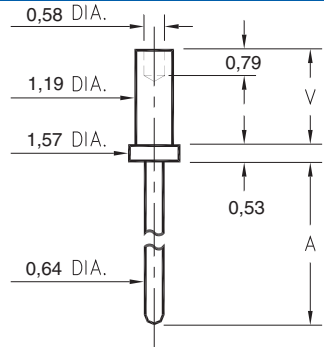

Basic Part Number	Board Thickness	Length A	Length V
3134-1	0,79	2,01	1,30
3134-2	1,57	2,01	2,08
3134-3	2,39	2,01	2,87
3134-4	3,18	2,01	3,68
3130-1	0,79	4,55	1,30
3130-2	1,57	4,55	2,08
3130-3	2,39	4,55	2,87
3130-4	3,18	4,55	3,68
3151-1	0,79	12,17	1,30
3151-2	1,57	12,17	2,08
3151-3	2,39	12,17	2,87
3151-4	3,18	12,17	3,68

**31XX-X-00-XX-00-00-08-0**  
Swage mount in 1,32 hole

### 3113

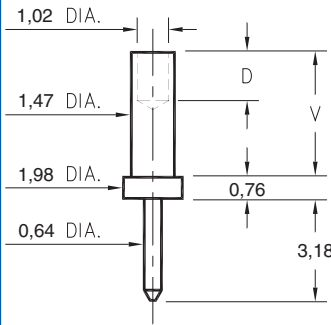

Basic Part Number	Board Thickness	Length V	Depth D
3113-1	0,79	1,57	1,02
3113-2	1,57	2,39	1,57
3113-3	2,39	3,18	1,57
3113-4	3,18	3,96	1,57

**3113-X-00-XX-00-00-08-0**  
Swage mount in 1,57 hole

### 3360

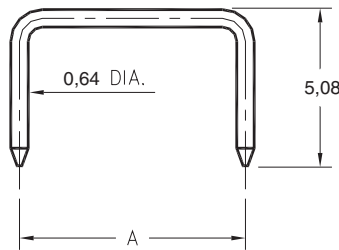

Basic Part Number	Pin Centers A
3360-1	5,08
3360-2	6,35
3360-3	7,62
3360-4	10,16
3360-5	12,7

**3360-X-14-XX-00-00-08-0**  
Shorting Jumper

### 3301 → 3304

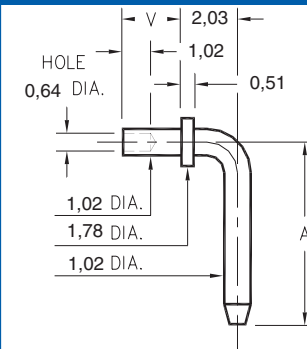

Basic Part Number	Pin Centers A
3301-X	6,53
3302-X	9,07
3303-X	9,53
3304-X	14,27

- X -	Board Thickness	Length V
1	0,79	1,30
2	1,57	2,08
3	2,39	2,87

**330X-X-14-XX-00-00-08-0**  
Specify board thickness  
Swage mount in 1,09 hole

### 3620

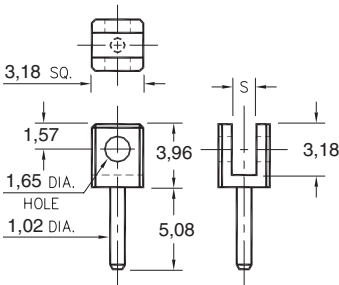

Basic Part Number	Board Thickness	Slot S
3620-1	0,79	1,19
3620-2	1,57	1,91

**3620-X-32-XX-00-00-08-0**  
Board edge rivet mount

### 0940

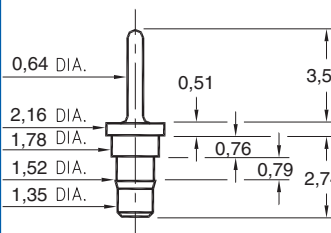

**0940-0-00-XX-00-00-03-0**  
Press-fit in 1,45 mounting hole

### 3621

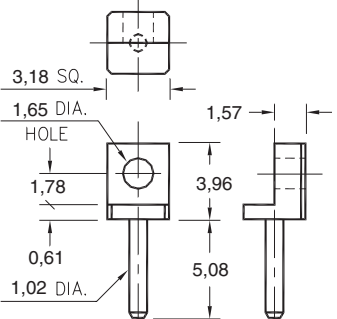

**3621-0-32-XX-00-00-08-0**  
Board edge rivet mount

#### SPECIFICATIONS

**PIN MATERIAL:**  
Brass Alloy 360, 1/2 Hard  
(Except Swage pins which are annealed)

**PART MANUFACTURED IN INCHES, METRIC FOR REF ONLY**

**TOLERANCES ON:**  
LENGTHS: ± 0,13  
DIAMETERS: ± 0,05  
ANGLES: ± 2°

**ORDER CODE: XXXX - X - XX - XX - 00 - 00 - 0X - 0**

**BASIC PART #**

**SPECIFY PIN FINISH:**

- 01 5,08µm TIN/LEAD OVER NICKEL
- 80 5,08µm TIN OVER NICKEL
- 15 0,25µm GOLD OVER NICKEL
- 21 0,51µm GOLD OVER NICKEL
- 34 1,27µm GOLD OVER NICKEL

