

SAW FILTER FOR JCDMA Rx Top

Murata part number : SAFEB859MAL0F00

Package Dimensions

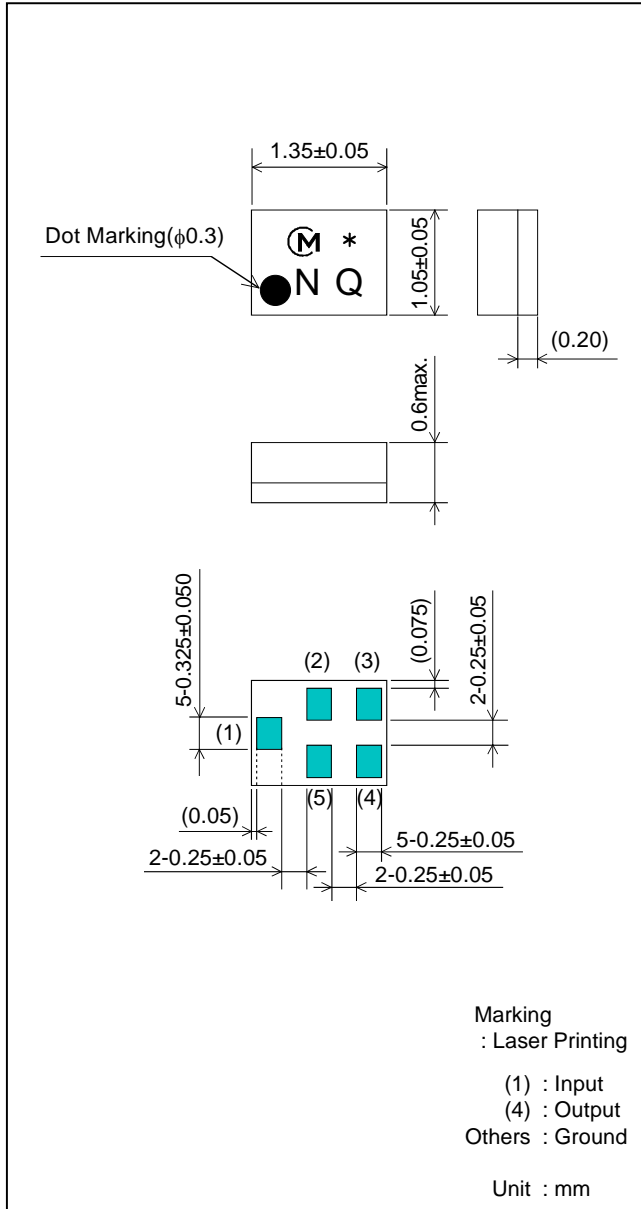

Specification

Item	Specification		
	-30 to 85°C	25 \pm 2°C	typ.
Nominal Center Frequency(fc)	859MHz		
Insertion Loss (843 to 875MHz)	3.2 dB max.	-	2.8 dB
(843 to 870MHz)	-	2.8 dB max.	2.6 dB
(870 to 875MHz)	-	3.1 dB max.	2.8 dB
Absolute Attenuation			
1) 0.3 to 750 MHz	50 dB min.	50 dB min.	63 dB
2) 750 to 815 MHz	48 dB min.	48 dB min.	59 dB
3) 815 to 824 MHz	42 dB min.	42 dB min.	51 dB
4) 824 to 830 MHz	43 dB min.	43 dB min.	46 dB
5) 830 to 835 MHz	5 dB min.	5 dB min.	24 dB
6) 835 to 840 MHz	2 dB min.	2 dB min.	3.2 dB
7) 898 to 925 MHz	45 dB min.	45 dB min.	49 dB
8) 925 to 1920 MHz	35 dB min.	35 dB min.	46 dB
9) 1920 to 1940 MHz	40 dB min.	40 dB min.	46 dB
10) 1940 to 1980 MHz	35 dB min.	35 dB min.	46 dB
11) 1980 to 3000 MHz	32 dB min.	32 dB min.	42 dB
12) 3000 to 4000 MHz	32 dB min.	32 dB min.	42 dB
Ripple Deviation (843 to 875MHz)	1.8dB max.	1.8dB max.	1.1 dB
VSWR (843 to 870MHz)	2.0 max.	1.9 max.	1.7
(870 to 875MHz)	2.2 max.	2.1 max.	1.8
Input/Output Impedance (nominal)	50 Ω		
Input Signal Level	20mW (+13dBm), 2000 hours		

SAW FILTER FOR JCDMA Rx Top

Murata part number : SAFEB859MAL0F00

■ Frequency Performance

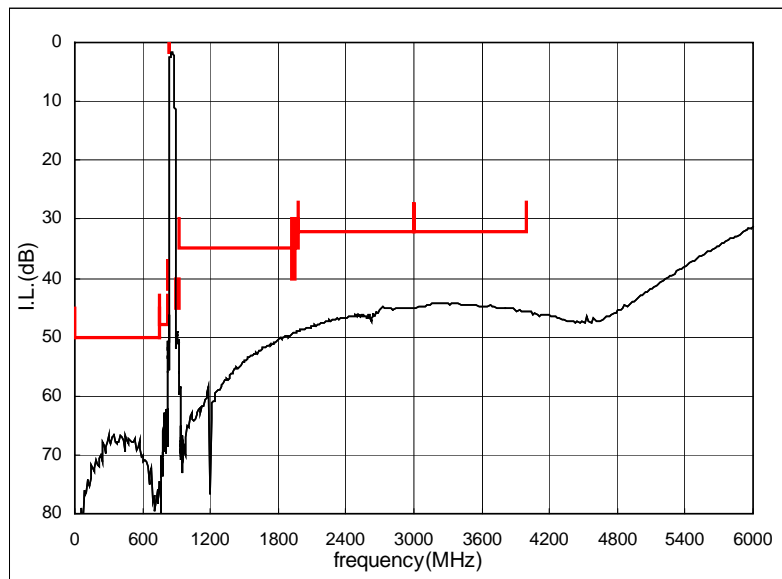
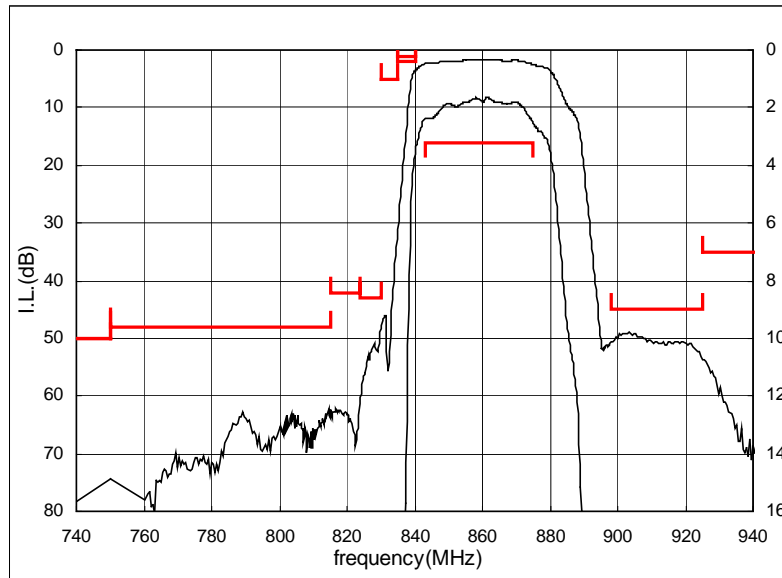

SAW FILTER FOR JCDMA Rx Top

Murata part number : SAFEB859MAL0F00

■ Dimensions of Carrier Tape

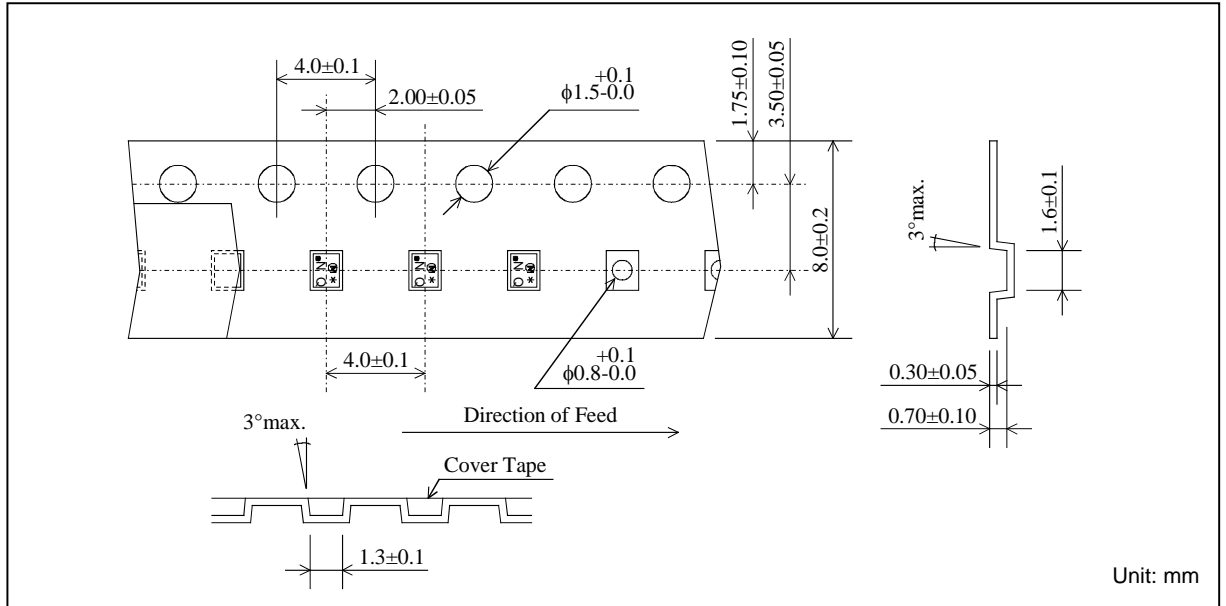

■ Dimensions of Tape

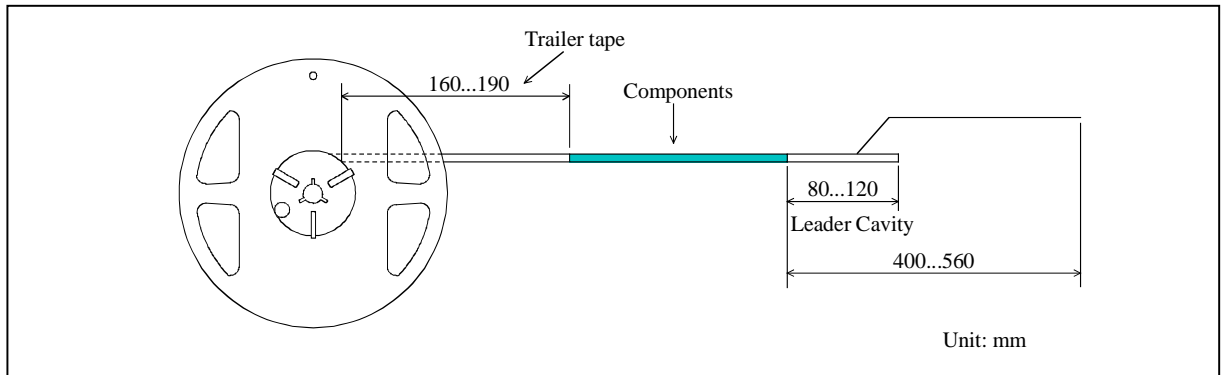

■ Dimensions of Reel

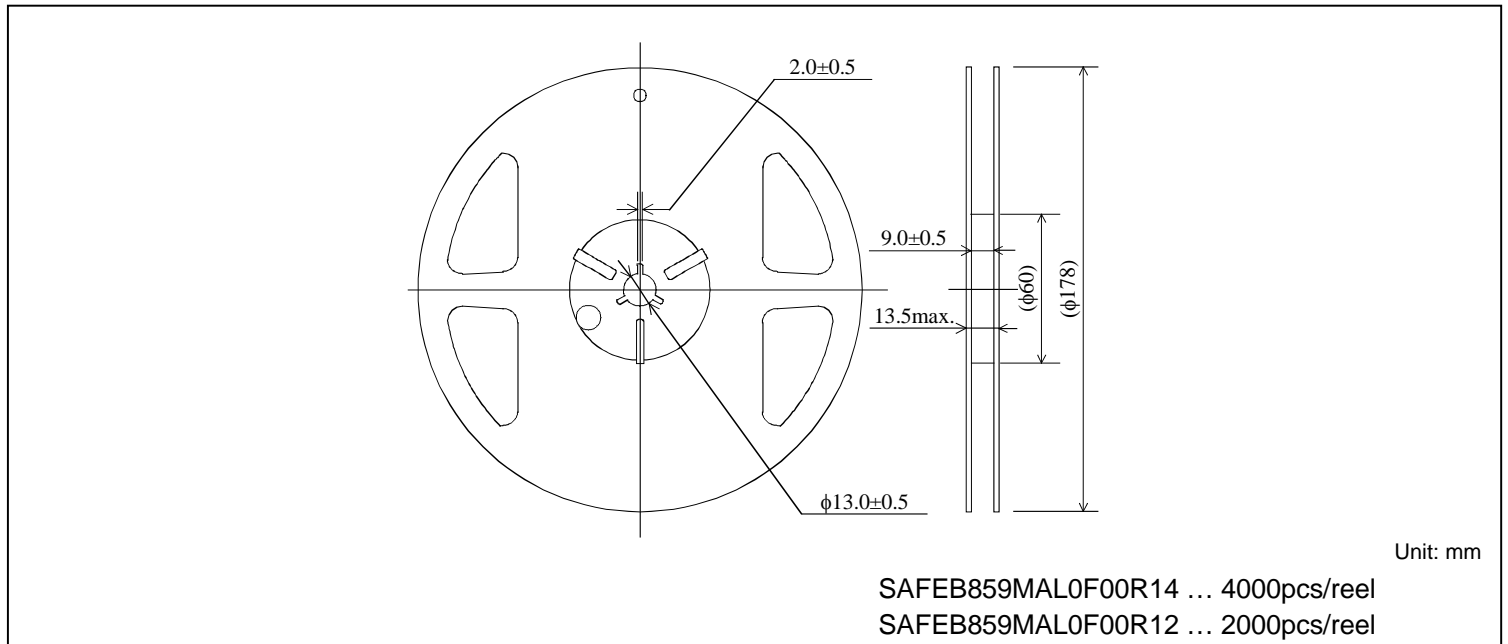

SAW FILTER FOR JCDMA Rx Top

Murata part number : SAFEB859MAL0F00

Recommended Land Pattern

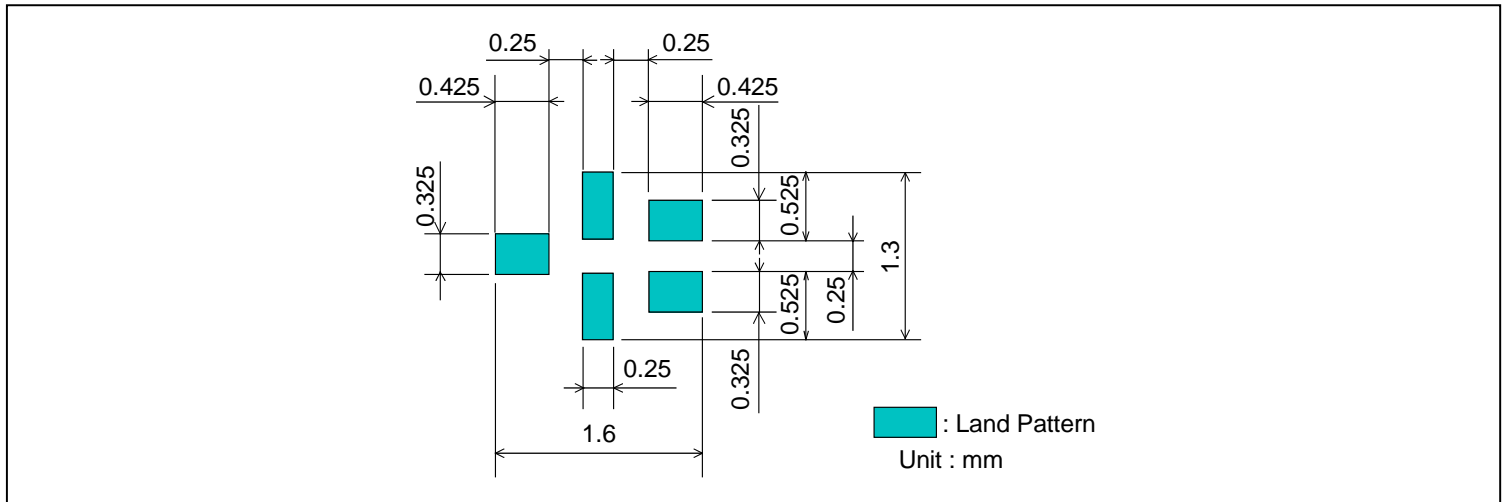

Test Circuit

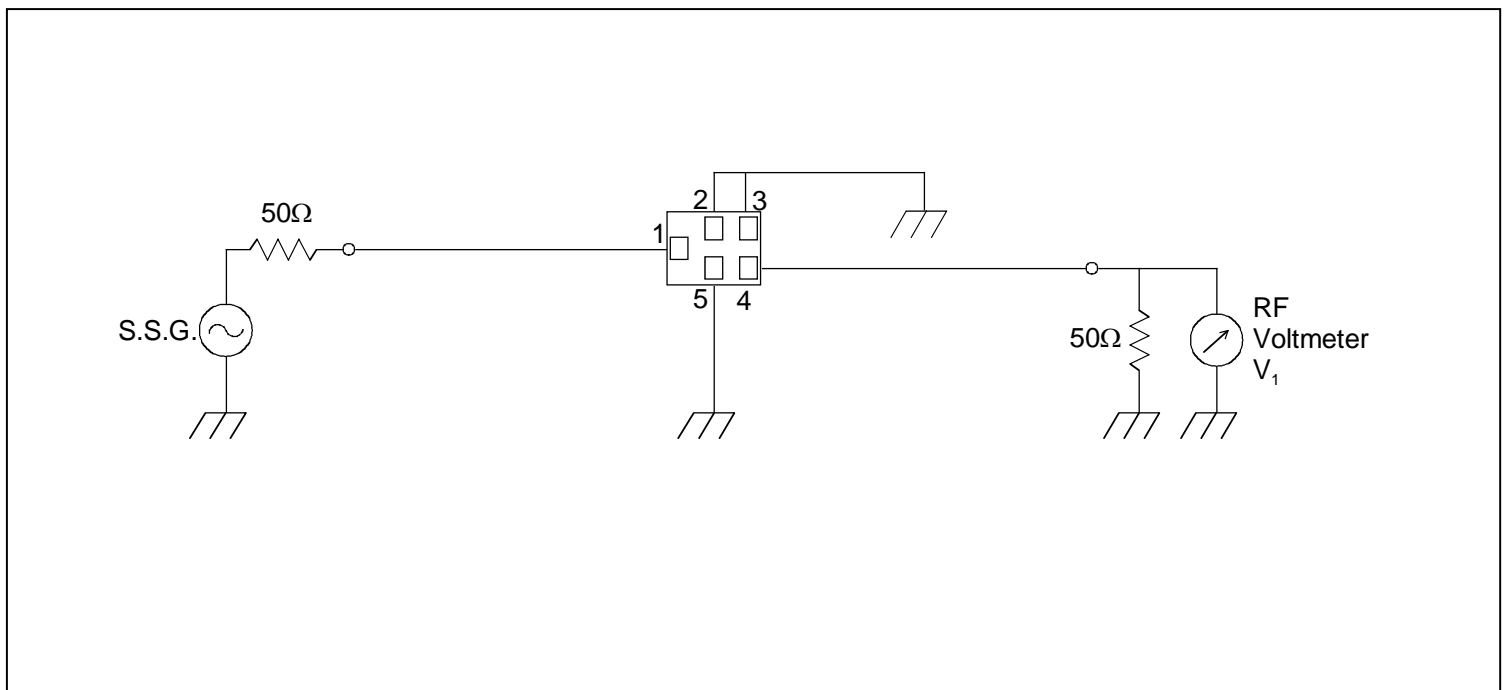

- This PDF Datasheet is downloaded from the website of Murata Manufacturing Co., Ltd. Therefore, it's specifications are subject to change or our products in it may be discontinued without advance notice. Please check with our sales representatives or product engineers before ordering.
- This PDF Datasheet has only typical specifications because there is no space for detailed specifications. Therefore, please approve our product specifications or transact the approval sheet for product specifications before ordering.