

# PME295RB4120MR30

aka P295BJ122M440A

Capacitor, film, 1200 pF, +/-20% Tol, -40/+115C, Safety: Y1, 440VAC,  
Lead Spacing=15 mm

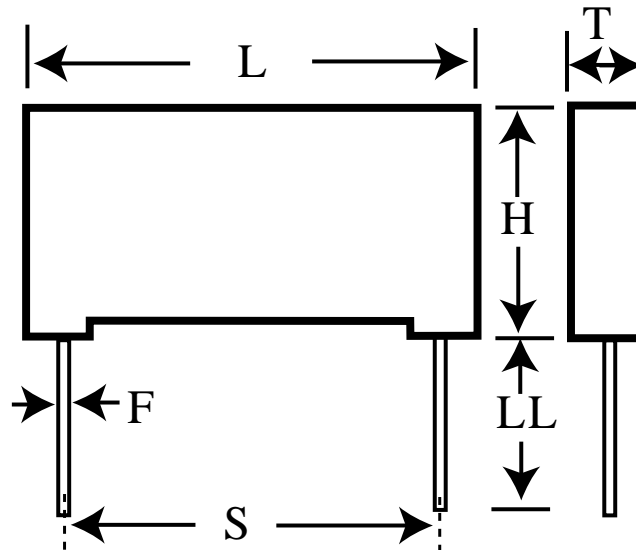

## Dimensions (mm)

ID	Dimension	Tolerance
L	18	max
H	12.5	max
T	6.5	max
S	15	+/-0.4
LL	30	nom
F	0.8	nom

## Specifications

Manufacturer:	KEMET
Brand:	Rifa
Capacitance:	1200 pF
Temperature Range:	-40/+115C
Rated Temperature:	115C
Voltage @ rated temp:	1500V
Voltage AC:	440VAC
Tolerance:	+/-20%
Body Type:	Radial Molded
Construction:	Non-inductive
Application:	Safety: Y1
Dielectric:	Metallized Paper
Dissipation Factor @ 1 kHz:	1.3%
Insulation Resistance:	12 GOhm
Maximum dVdT:	2000v/us
UL_1414:	250V
UL_1283:	480V
IEC_60384-14:	440V
EN_132400:	440V
C_22.2_NO.1:	250V
C_22.2_NO.8:	480V
Miscellaneous Electrical:	PME295
Package Kind:	Bulk
Package Quantity:	400