

# SOLID TANTALUM CHIP CAPACITORS

## T510 SERIES—High Capacitance-Low ESR



Solid Tantalum Surface Mount

### FEATURES

- Ultra Low ESR < 30 mΩ
- New E/7260 Case with ESR < 18 mΩ
- Up to 5 Amps ripple current
- RoHS Compliant & Leadfree Termination (see [www.kemet.com](http://www.kemet.com) for lead transitions)
- Operating Temperature: -55°C to +125°C
- 100% accelerated steady-state aging
- 100% Surge current test
- Precision - molded, laser-marked case
- Symmetrical compliant terminations
- Taped and reeled per EIA 481-1

### OUTLINE DRAWING

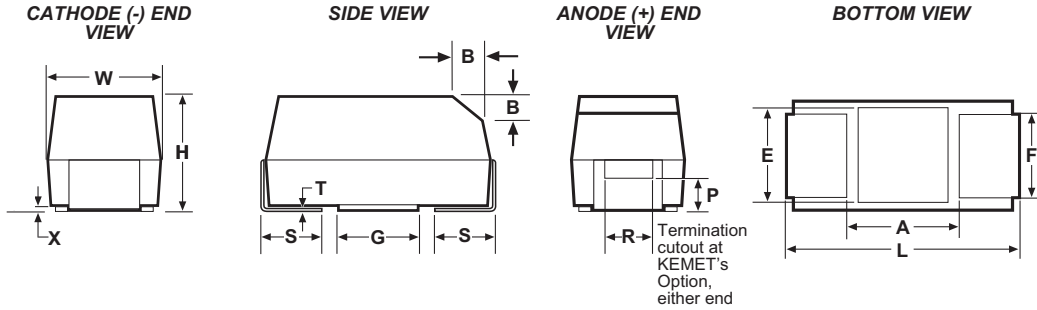

### DIMENSIONS - Millimeters (Inches)

Case Size		Component												
KEMET	EIA	L	W	H	F ± 0.1 ± (.004)	S ± 0.3 ± (.012)	B ± 0.15 (Ref) ± .006	X (Ref)	P (Ref)	R (Ref)	T (Ref)	A (Min)	G (Ref)	E (Ref)
X	7343-43	7.3 ± 0.3 (.287 ± .012)	4.3 ± 0.3 (.169 ± .012)	4.0 ± 0.3 (.157 ± .012)	2.4 (.094)	1.3 (.051)	0.5 (.020)	0.10 ± 0.10 (.004 ± .004)	1.7 (.067)	1.0 (.039)	0.13 (.005)	3.8 (.150)	3.5 (.138)	3.5 (.138)
E	7260-38	7.3 ± 0.3 (.287 ± .012)	6.0 ± 0.3 (.236 ± .012)	3.6 ± 0.2 (.142 ± .008)	4.1 (.161)	1.3 (.051)	0.5 (.020)	0.10 ± 0.10 (.004 ± .004)	0.9 (.035)	1.0 (.039)	0.13 (.005)	3.8 (.150)	3.5 (.138)	3.5 (.138)

Notes: 1. Metric dimensions govern  
2. (Ref) Dimensions provided for reference only.

### T510 RATINGS & PART NUMBER REFERENCE

Cap μF	Case Size	KEMET Part Number	DC Leakage μA @ +25°C Max	DF % @ +25°C 120Hz Max	ESR mΩ @ +25°C 100 kHz Max	Ripple Current Arms @ +25°C, 100 kHz, max		
						25°C	85°C	125°C
<b>4 Volt Rating at +85°C (2.7 Volt Rating at 125°C)</b>								
680.0	X	T510X687(1)004A(2)E030	27.2	6.0	30	3.0	2.7	1.2
1000.0	X	T510X108(1)004A(2)E018	40.0	6.0	18	3.9	3.5	1.5
1000.0	X	T510X108(1)004A(2)E023	40.0	6.0	23	3.4	3.0	1.3
1000.0	E	T510E108(1)004A(2)E018	40.0	6.0	18	4.0	3.6	1.6
1000.0	E	T510E108(1)004A(2)E010	40.0	6.0	10	5.3	4.8	2.1
<b>6/6.3 Volt Rating at +85°C (4 Volt Rating at 125°C)</b>								
470.0	X	T510X477(1)006A(2)E030	28.2	6.0	30	3.0	2.7	1.2
680.0	X	T510X687(1)006A(2)E023	42.8	6.0	23	3.4	3.1	1.4
680.0	E	T510E687(1)006A(2)E023	40.8	6.0	23	3.5	3.2	1.4
680.0	E	T510E687(1)006A(2)E012	40.8	6.0	12	4.8	4.3	1.9
<b>10 Volt Rating at +85°C (7 Volt Rating at 125°C)</b>								
330.0	X	T510X337(1)010A(2)E035	33.0	6.0	35	2.8	2.5	1.1
<b>16 Volt Rating at +85°C (11 Volt Rating at 125°C)</b>								
150.0	X	T510X157(1)016A(2)E030	24.0	6.0	30	3.0	2.7	1.2
150.0	X	T510X157(1)016A(2)E040	24.0	6.0	40	2.6	2.3	1.0
220.0	X	T510X227(1)016A(2)E040	35.2	10.0	40	2.6	2.3	1.0
220.0	X	T510X227(1)016A(2)E025	35.2	10.0	25	3.3	3.0	1.3

Cap μF	Case Size	KEMET Part Number	DC Leakage μA @ +25°C Max	DF % @ +25°C 120Hz Max	ESR mΩ @ +25°C 100 kHz Max	Ripple Current Arms @ +25°C, 100 kHz, max		
						25°C	85°C	125°C
<b>20 Volt Rating at +85°C (13.4 Volt Rating at 125°C)</b>								
100.0	X	T510X107(1)020A(2)E035	20.0	8.0	35.0	2.8	2.5	1.1
100.0	X	T510X107(1)020A(2)E040	20.0	6.0	40.0	2.6	2.3	1.0
100.0	X	T510X107(1)020A(2)E045	20.0	6.0	45.0	2.4	2.2	0.9
<b>25 Volt Rating at +85°C (17 Volt Rating at 125°C)</b>								
68.0	X	T510X686(1)025A(2)E045	17.0	8.0	45	2.4	2.1	1.0
100.0	E	T510E107(1)025A(2)E050	25.0	8.0	50	2.4	2.1	1.0
<b>35 Volt Rating at +85°C (23 Volt Rating at 125°C)</b>								
22.0	X	T510X226(1)035A(2)E100	7.7	6.0	100	1.6	1.4	0.6
22.0	X	T510X226(1)035A(2)E080	7.7	6.0	80	1.8	1.7	0.7
22.0	X	T510X226(1)035A(2)E060	7.7	6.0	60	2.1	1.9	0.8
33.0	X	T510X336(1)035A(2)E065	11.6	6.0	65	2.0	1.8	0.8
33.0	X	T510X336(1)035A(2)E050	11.6	6.0	50	2.3	2.1	0.9
47.0	X	T510X476(1)035A(2)E055	16.5	8.0	55	2.2	2.0	0.9
47.0	X	T510X476(1)035A(2)E065	16.5	8.0	65	2.0	1.8	0.8
47.0	E	T510E476(1)035A(2)E050	16.5	8.0	50	2.4	2.1	1.0
<b>50 Volt Rating at +85°C (33 Volt Rating at 125°C)</b>								
10.0	X	T510X106(1)050A(2)E120	5.0	8.0	120	1.5	1.3	0.6
10.0	X	T510X106(1)050A(2)E090	5.0	8.0	90	1.7	1.6	0.7

(1) To complete KEMET part number insert  
"K" - ±10% or "M" - ±20% capacitance tolerance.  
(2) To complete KEMET part number, insert H (SnPb)  
or T - 100% tin.

### T510 ORDERING INFORMATION

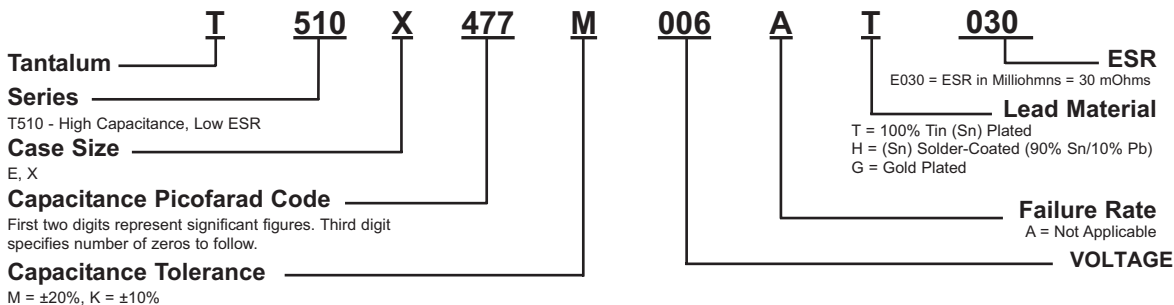

**TYPICAL CAP FREQUENCY SCAN @ 25°C**  
T510X477M006AS

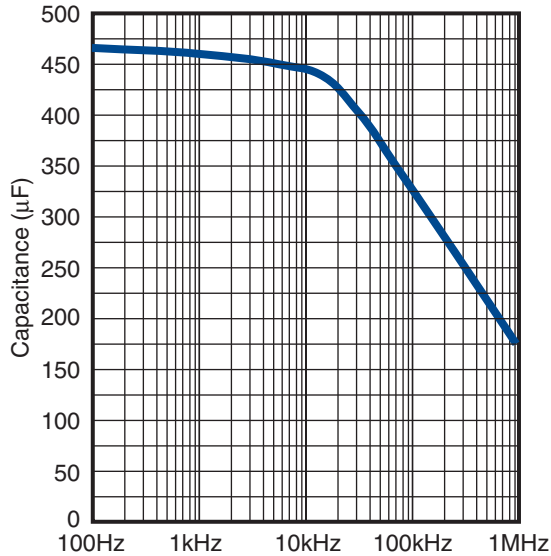

**TYPICAL ESR/Z FREQUENCY SCAN @ 25°C**  
T510X477M006AS

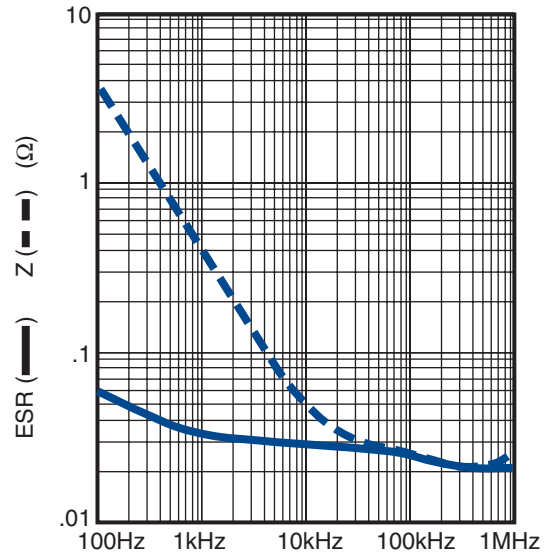

**TYPICAL CAP FREQUENCY SCAN @ 25°C**  
T510E108M004AS

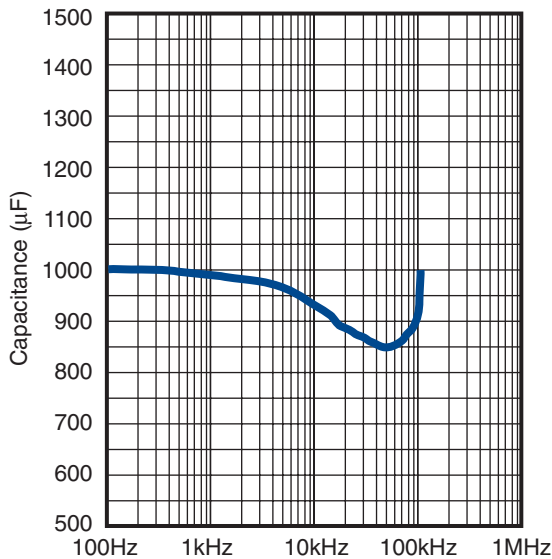

**TYPICAL ESR/Z FREQUENCY SCAN @ 25°C**  
T510E108M004AS

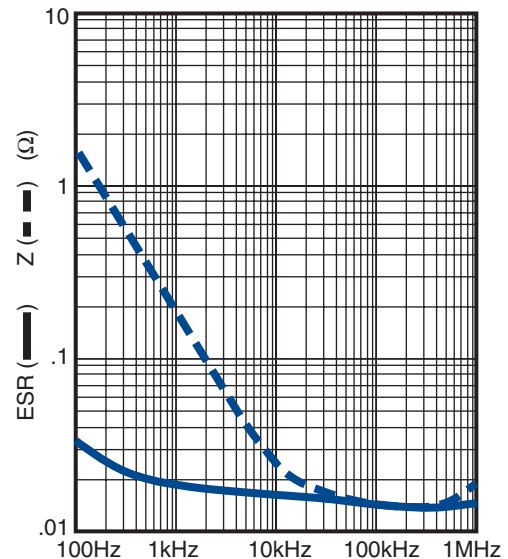

**CAPACITOR ALTERNATE MARKINGS**

Date Code Year	Date Code Month	
S = 2004	1 = Jan	7 = Jul
T = 2005	2 = Feb	8 = Aug
U = 2006	3 = Mar	9 = Sep
V = 2007	4 = Apr	10 = Oct
W = 2008	5 = May	11 = Nov
X = 2009	6 = Jun	12 = Dec

Date Code Year	Date Code Month	
S = 2004	1 = Jan	7 = Jul
T = 2005	2 = Feb	8 = Aug
U = 2006	3 = Mar	9 = Sep
V = 2007	4 = Apr	10 = Oct
W = 2008	5 = May	11 = Nov
X = 2009	6 = Jun	12 = Dec

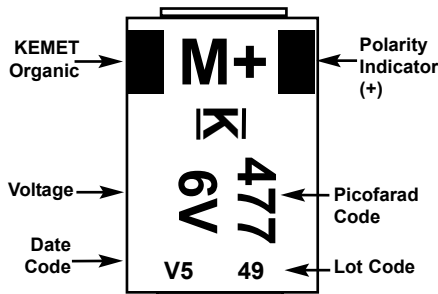

**T510**  
**CAPACITOR MARKINGS**

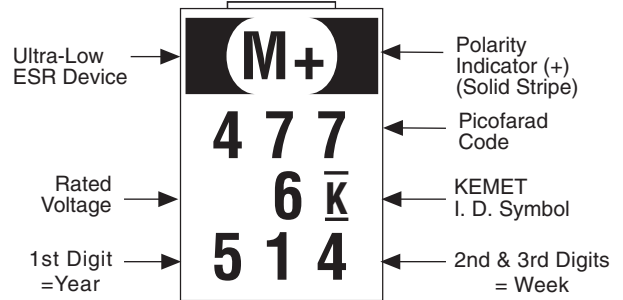

"514" = The 14th week of 2005.

## Tape & Reel Packaging

KEMET's Molded Tantalum and Aluminum Chip Capacitor families are packaged in 8 mm and 12 mm plastic tape on 7" and 13" reels, in accordance with EIA Standard 481-1: Taping of Surface Mount Components for Automatic Handling. This packaging system is compatible with all tape fed automatic pick and place systems.

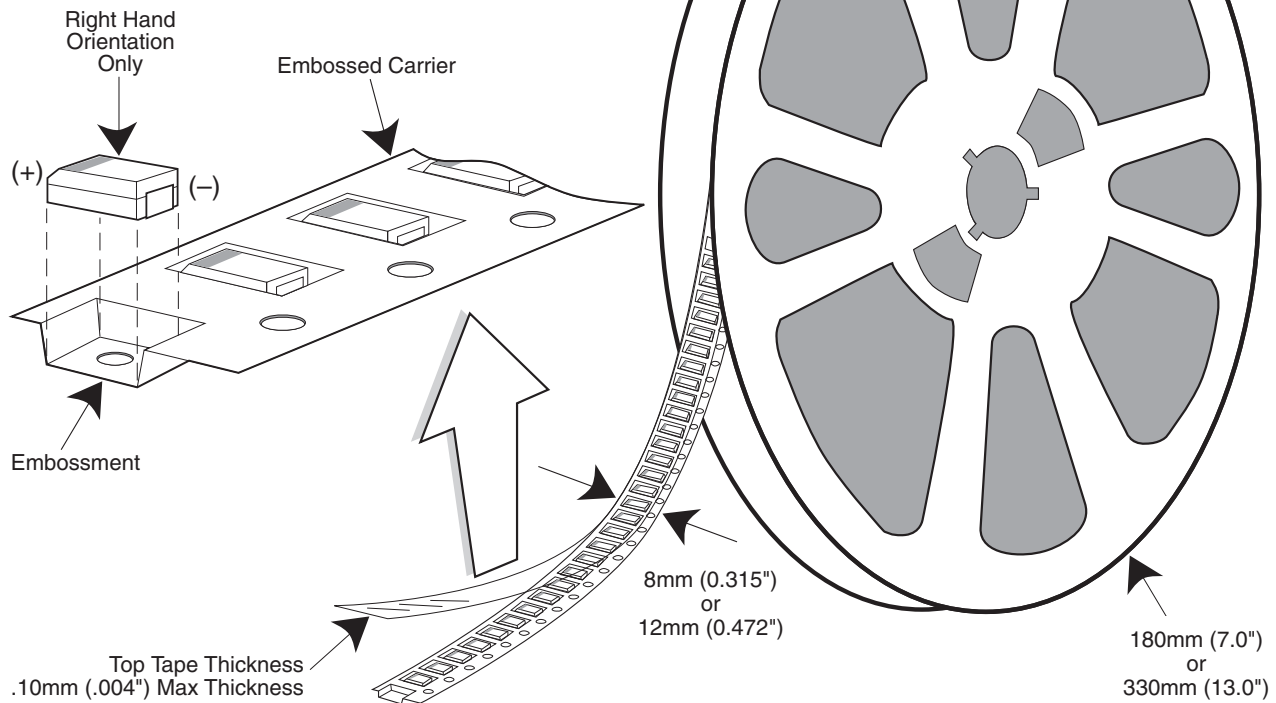

**Labeling:** Bar code labeling (standard or custom) shall be on the side of the reel opposite the sprocket holes. Refer to EIA-556.

### QUANTITIES PACKAGED PER REEL

Case Code		Tape Width-mm	7" Reel*	13" Reel
KEMET	EIA			
R	2012-12	8	2,500	10,000
I	3216-10	8	3,000	12,000
S	3216-12	8	2,500	10,000
T	3528-12	8	2,500	10,000
M	3528-15	8	2,000	8,000
U	6032-15	12	1,000	5,000
L	6032-19	12	1,000	5,000
W	7343-15	12	1,000	3,000
Z	7343-17	12	1,000	3,000
V	7343-20	12	1,000	3,000
A	3216-18	8	2,000	9,000
B	3528-21	8	2,000	8,000
C	6032-28	12	500	3,000
D	7343-31	12	500	2,500
Y	7343-40	12	500	2,000
X	7343-43	12	500	2,000
E	7260-38	12	500	2,000

\* No c-spec required for 7" reel packaging. C-7280 required for 13" reel packaging.

# TANTALUM, CERAMIC AND ALUMINUM CHIP CAPACITORS

## Packaging Information

### Performance Notes

- Cover Tape Break Force:** 1.0 Kg Minimum.
- Cover Tape Peel Strength:** The total peel strength of the cover tape from the carrier tape shall be:

Tape Width	Peel Strength
8 mm	0.1 Newton to 1.0 Newton (10g to 100g)
12 mm	0.1 Newton to 1.3 Newton (10g to 130g)

The direction of the pull shall be opposite the direction of the carrier tape travel. The pull angle of the carrier tape shall be 165° to 180° from the plane of the carrier tape. During peeling, the carrier and/or cover tape shall be pulled at a velocity of 300 ±10 mm/minute.

- Reel Sizes:** Molded tantalum capacitors are available on either 180 mm (7") reels (standard) or 330 mm (13") reels (with C-7280). Note that 13" reels are preferred.
- Labeling:** Bar code labeling (standard or custom) shall be on the side of the reel opposite the sprocket holes. Refer to EIA-556.

### Embossed Carrier Tape Configuration: Figure 1

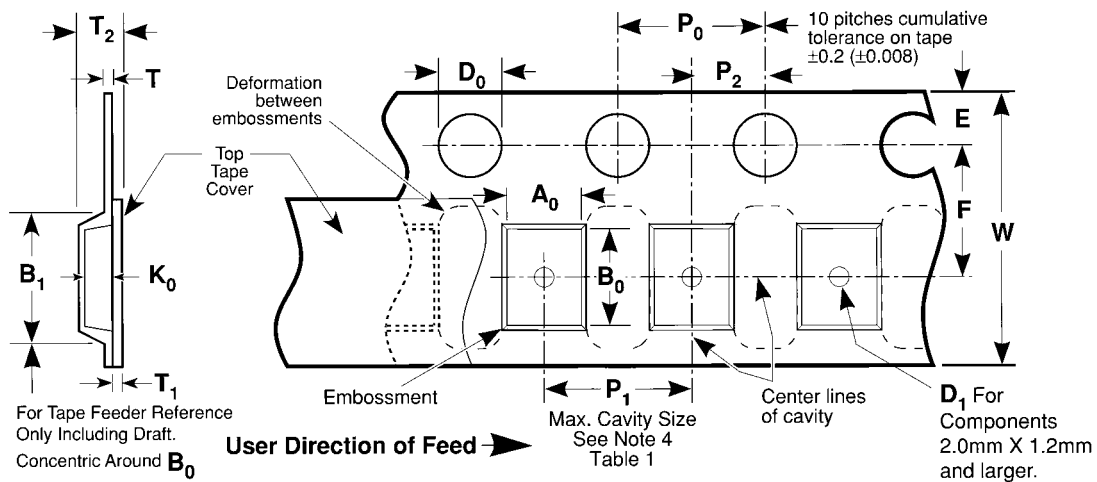

**Table 1 — EMBOSSED TAPE DIMENSIONS (Metric will govern)**

Constant Dimensions — Millimeters (Inches)									
Tape Size	D <sub>0</sub>	E	P <sub>0</sub>	P <sub>2</sub>	T Max	T <sub>1</sub> Max			
8 mm and 12 mm	1.5 +0.10 -0.0 (0.059 +0.004, -0.0)	1.75 ±0.10 (0.069 ±0.004)	4.0 ±0.10 (0.157 ±0.004)	2.0 ±0.05 (0.079 ±0.002)	0.600 (0.024)	0.100 (0.004)			
Variable Dimensions — Millimeters (Inches)									
Tape Size	Pitch	B <sub>1</sub> Max. Note 1	D <sub>1</sub> Min. Note 2	F	P <sub>1</sub>	R Min. Note 3	T <sub>2</sub> Max	W	A <sub>0</sub> B <sub>0</sub> K <sub>0</sub> Note 4
8 mm	Single (4 mm)	4.4 (0.173)	1.0 (0.039)	3.5 ±0.05 (0.138 ±0.002)	4.0 ±0.10 (0.157 ±0.004)	25.0 (0.984)	2.5 (0.098)	8.0 ±0.30 (.315 ±0.012)	
12 mm	Double (8 mm)	8.2 (0.323)	1.5 (0.059)	5.5 ±0.05 (0.217 ±0.002)	8.0 ±0.10 (0.315 ±0.004)	30.0 (1.181)	4.6 (0.181)	12.0 ±0.30 (0.472 ±0.012)	

### NOTES

- B1 dimension is a reference dimension for tape feeder clearance only.
- The embossment hole location shall be measured from the sprocket hole controlling the location of the embossment. Dimensions of embossment location and hole location shall be applied independent of each other.
- Tape with components shall pass around radius "R" without damage (see sketch A). The minimum trailer length (Fig. 2) may require additional length to provide R min. for 12 mm embossed tape for reels with hub diameters approaching N min. (Table 2)
- The cavity defined by A<sub>0</sub>, B<sub>0</sub>, and K<sub>0</sub> shall be configured to surround the part with sufficient clearance such that the chip does not protrude beyond the sealing plane of the cover tape, the chip can be removed from the cavity in a vertical direction without mechanical restriction, rotation of the chip is limited to 20 degrees maximum in all 3 planes, and lateral movement of the chip is restricted to 0.5 mm maximum in the pocket (not applicable to vertical clearance.)

### Embossed Carrier Tape Configuration (cont.)



### Sketch D: Tape Camber (Top View)



**Figure 2:** Tape Leader & Trailer Dimensions (Metric Dimensions Will Govern)

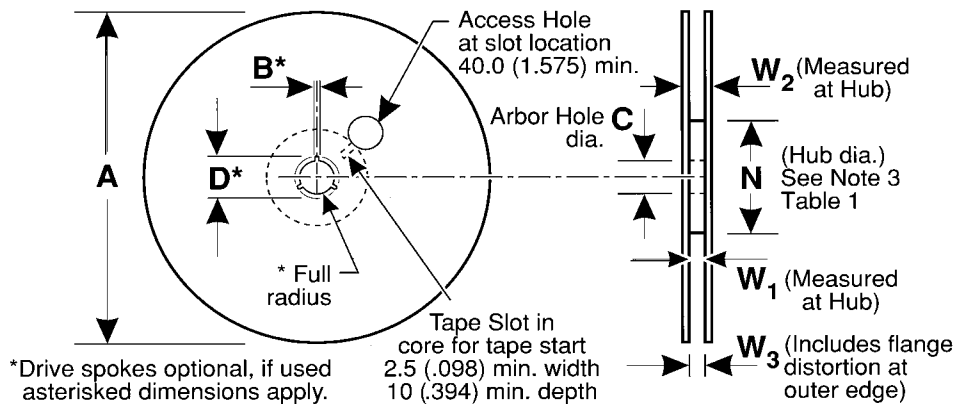

**Figure 3:** Reel Dimensions (Metric Dimensions will govern)

**Table 2 – REEL DIMENSIONS (Metric will govern)**

Tape Size	A Max	$B^*$ Min	C	$D^*$ Min	N Min	$W_1$	$W_2$ Max	$W_3$
8 mm	330.0 (12.992)	1.5 (0.059)	13.0 ± 0.20 (0.512 ± 0.008)	20.2 (0.795)	50.0 (1.969) See Note 3 Table 1	8.4 +1.5, -0.0 (0.331 +0.059, -0.0)	14.4 (0.567)	7.9 Min (0.311) 10.9 Max (0.429)
12 mm	330.0 (12.992)	1.5 (0.059)	13.0 ± 0.20 (0.512 ± 0.008)	20.2 (0.795)	Table 1	12.4 +2.0, -0.0 (0.488 +0.078, -0.0)	18.4 (0.724)	11.9 Min (0.469) 15.4 Max (0.606)