

FEATURES

- **LOW VOLTAGE - LOW CURRENT:** 5 mA at 3 V
- **LOW POWER CONSUMPTION:** 15 mW TYP
- **SUPER SMALL PACKAGE**
- **TAPE AND REEL PACKAGING OPTION AVAILABLE**

DESCRIPTION

The UPC2747T is a Silicon Monolithic integrated circuit which is manufactured using the NESAT III process. The NESAT III process produces transistors with f_T approaching 20 GHz. This amplifier was designed for 900 MHz receivers in cellular and cordless telephone applications. Operating on a 3 volt supply (1.8 volt minimum) this IC is ideally suited for hand-held, portable designs.

NEC's stringent quality assurance and test procedures ensure the highest reliability and performance.

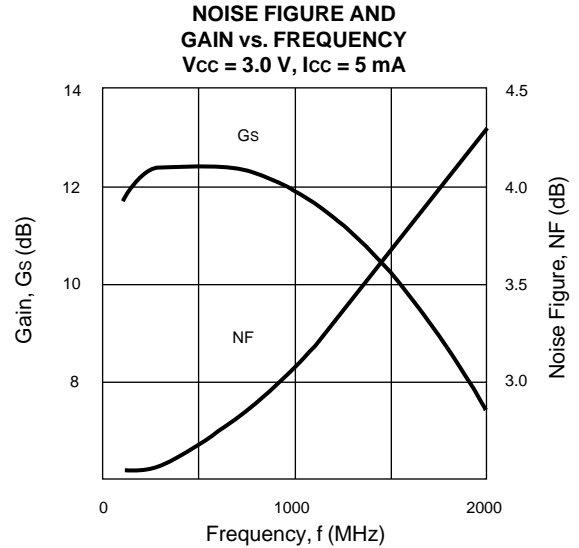

ELECTRICAL CHARACTERISTICS (TA = 25°C, ZL = ZS = 50 Ω)

PART NUMBER PACKAGE OUTLINE			UPC2747T TO6		
SYMBOLS	PARAMETERS AND CONDITIONS	UNITS	MIN	TYP	MAX
Icc	Circuit Current (no signal) Vcc = 3.0 V Vcc = 1.8 V	mA mA	3.8	5.0 3.0	7.0
Gs	Small Signal Gain, f = 900 MHz, Vcc = 3.0 V f = 900 MHz, Vcc = 1.8 V	dB dB	9	12 5.5	14
fu ¹	Upper Limit Operating Frequency, Vcc = 3.0 V Vcc = 1.8 V	GHz GHz	1.5	1.8 1.8	
PSAT	Saturated Output Power, f = 900 MHz, Vcc = 3.0 V f = 900 MHz, Vcc = 1.8 V	dBm dBm	-9.5	-7 -14	
NF	Noise Figure, f = 900 MHz, Vcc = 3.0 V f = 900 MHz, Vcc = 1.8 V	dB dB		3.3 5.2	4.5
RLIN	Input Return Loss, f = 900 MHz, Vcc = 3.0 V f = 900 MHz, Vcc = 1.8 V	dB dB	11	14 11	
RLOUT	Output Return Loss, f = 900 MHz, Vcc = 3.0 V f = 900 MHz, Vcc = 1.8 V	dB dB	7	10 13	
ISOL	Isolation, f = 900 MHz, Vcc = 3.0 V f = 900 MHz, Vcc = 1.8 V	dB dB	35	40 34	
OIP3	SSB Output Third Order Intercept, f1 = 500 MHz, f2 = 510 MHz, Vcc = 3.0 V f1 = 900 MHz, f2 = 902 MHz, Vcc = 3.0 V f1 = 1000 MHz, f2 = 1010 MHz, Vcc = 3.0 V f1 = 900 MHz, f2 = 902 MHz, Vcc = 1.8 V	dBm dBm dBm dBm		-3 -3 -2 -10	
RTH (J-A)	Thermal Resistance (Junction to Ambient) Free Air Mounted on a 50 x 50 x 1.6 mm epoxy glass PWB	°C/W °C/W			620 230

Note:

1. The gain at fu is 3 dB down from the gain at 100 MHz.

ABSOLUTE MAXIMUM RATINGS¹ (T_A = 25°C)

SYMBOLS	PARAMETERS	UNITS	RATINGS
V _{CC}	Supply Voltage	V	4.0
I _{CC}	Total Supply Current	mA	15
P _{IN}	Input Power	dBm	0
P _T	Total Power Dissipation ²	mW	280
T _{OP}	Operating Temperature	°C	-40 to +85
T _{STG}	Storage Temperature	°C	-55 to +150

Notes:

1. Operation in excess of any one of these parameters may result in permanent damage.
2. Mounted on a 50 x 50 x 1.6 mm epoxy glass PWB (T_A = 85°C).

RECOMMENDED OPERATING CONDITIONS

SYMBOLS	PARAMETERS	UNITS	MIN	TYP	MAX
V _{CC}	Supply Voltage	V	1.8	3	3.3
T _{OP}	Operating Temperature	°C	-40	25	85

TEST CIRCUIT

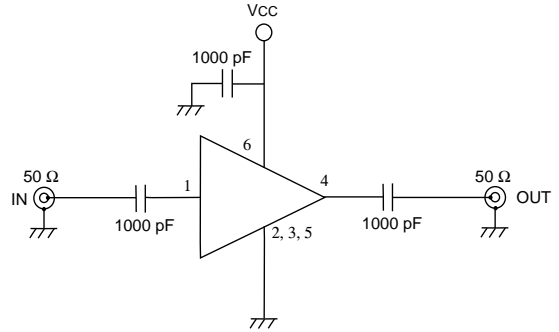

TYPICAL PERFORMANCE CURVES (T_A = 25°C)

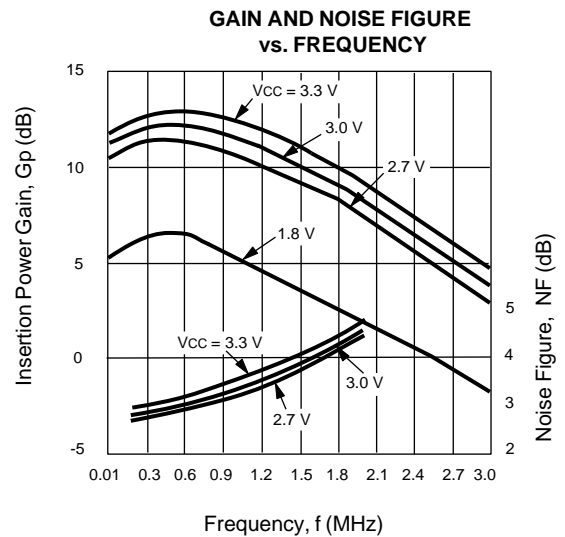
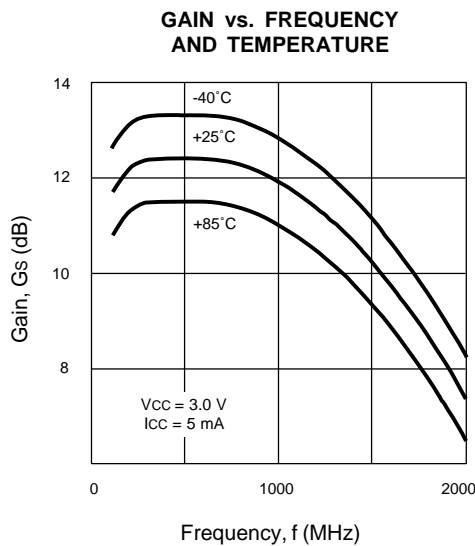
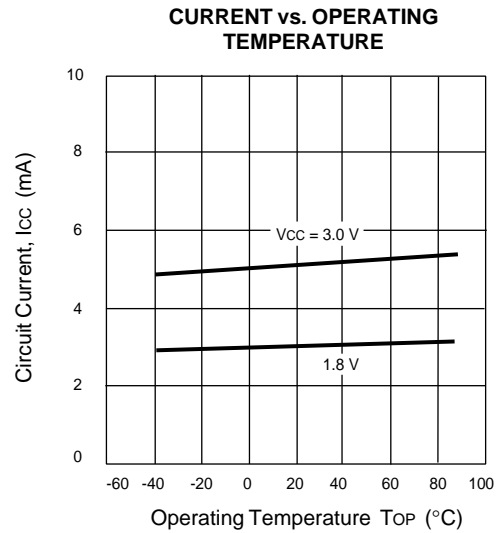
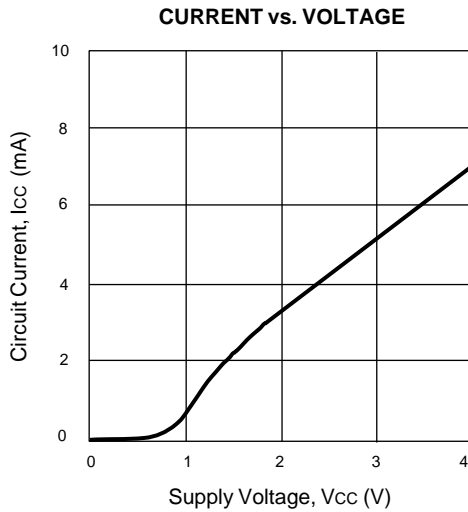

TYPICAL PERFORMANCE CURVES (TA = 25°C, unless otherwise specified)

RETURN LOSS vs. FREQUENCY

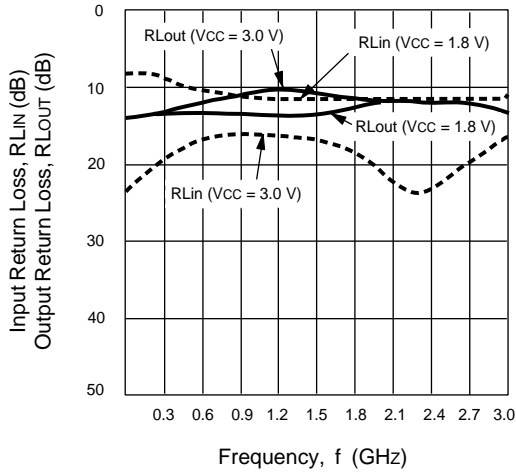

ISOLATION vs. FREQUENCY

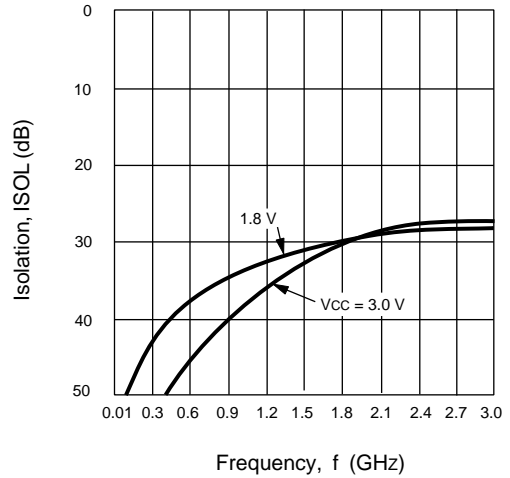

POWER vs. FREQUENCY

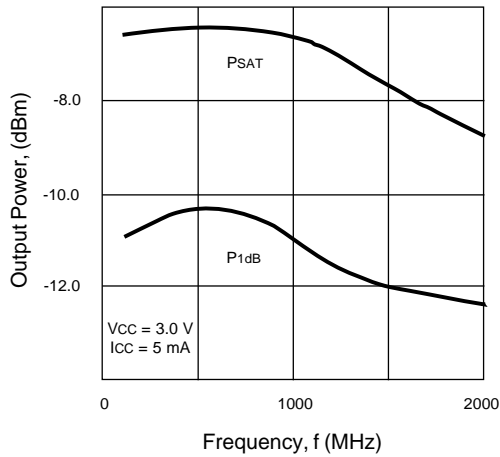

POWER vs. FREQUENCY

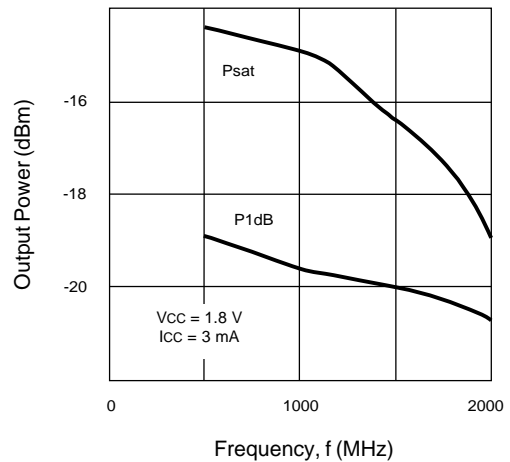

OUTPUT POWER vs. INPUT POWER AND VOLTAGE

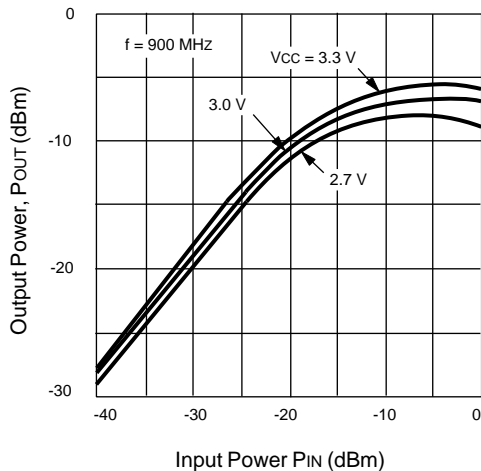

OUTPUT POWER vs. INPUT POWER AND TEMPERATURE

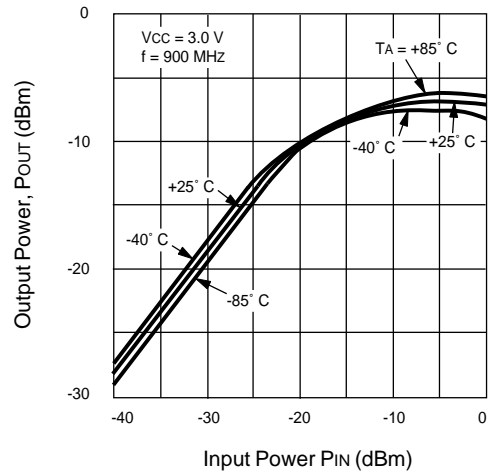

TYPICAL SCATTERING PARAMETERS (T_A = 25°C)

V_{CC} = 3.0 V, I_{CC} = 5.0 mA

FREQUENCY (GHz)	S ₁₁		S ₂₁		S ₁₂		S ₂₂		K ¹	S ₂₁ (dB)
	MAG	ANG	MAG	ANG	MAG	ANG	MAG	ANG		
0.1	0.061	-175.8	3.84	-4.0	0.001	120.5	0.249	-1.9	121.68	11.7
0.2	0.075	-168.9	4.10	-12.5	0.001	118.8	0.255	-4.2	113.38	12.3
0.3	0.093	-167.4	4.18	-23.0	0.002	117.0	0.261	-5.7	55.26	12.4
0.4	0.117	-174.1	4.17	-33.0	0.003	115.2	0.266	-7.0	36.64	12.4
0.5	0.134	175.3	4.15	-42.5	0.004	113.7	0.272	-8.7	27.40	12.4
0.6	0.142	163.9	4.12	-52.0	0.004	112.2	0.277	-10.6	27.46	12.3
0.7	0.152	153.7	4.07	-61.1	0.005	110.8	0.281	-13.1	22.12	12.2
0.8	0.159	142.9	4.02	-70.7	0.006	109.3	0.283	-15.8	18.60	12.1
0.9	0.154	131.7	3.97	-80.0	0.008	107.8	0.288	-19.3	14.11	12.0
1.0	0.148	120.7	3.92	-90.2	0.009	106.3	0.287	-22.6	12.73	11.9
1.1	0.143	110.5	3.83	-99.3	0.012	104.8	0.287	-27.6	9.79	11.7
1.2	0.139	101.1	3.70	-108.1	0.013	103.4	0.284	-30.2	9.39	11.4
1.3	0.135	88.5	3.55	-117.0	0.014	101.9	0.279	-34.7	9.12	11.0
1.4	0.131	80.9	3.38	-126.2	0.015	100.4	0.272	-37.3	8.99	10.6
1.5	0.126	71.1	3.23	-134.8	0.016	98.0	0.264	-41.3	8.87	10.2
1.6	0.121	61.5	3.07	-143.3	0.017	95.6	0.256	-43.7	8.84	9.7
1.7	0.120	55.6	2.89	-150.9	0.018	93.2	0.243	-45.8	8.93	9.2
1.8	0.118	48.0	2.72	-158.8	0.020	92.6	0.234	-46.2	8.58	8.7
1.9	0.113	42.9	2.53	-166.6	0.022	91.6	0.219	-47.0	8.46	8.1
2.0	0.105	34.7	2.32	-173.1	0.024	89.2	0.209	-46.4	8.51	7.3

V_{CC} = 1.8 V, I_{CC} = 3.0 mA

FREQUENCY GHz	S ₁₁		S ₂₁		S ₁₂		S ₂₂		K ¹	S ₂₁ (dB)
	MAG	ANG	MAG	ANG	MAG	ANG	MAG	ANG		
0.1	0.436	-6.3	1.79	-5.1	0.003	63.5	0.259	-3.8	70.31	5.1
0.2	0.428	-15.1	1.89	-14.8	0.004	62.0	0.260	-8.1	50.34	5.5
0.3	0.416	-23.9	1.94	-26.3	0.005	60.6	0.259	-11.9	39.74	5.8
0.4	0.388	-30.7	1.97	-37.5	0.006	59.1	0.256	-13.9	33.54	5.9
0.5	0.366	-37.2	1.96	-49.1	0.008	57.6	0.252	-17.5	25.83	5.8
0.6	0.352	-41.4	1.92	-60.3	0.009	56.1	0.247	-19.9	23.77	5.7
0.7	0.337	-46.8	1.87	-71.0	0.011	54.6	0.240	-24.3	29.27	5.4
0.8	0.332	-50.4	1.82	-81.8	0.013	53.2	0.232	-25.9	17.75	5.2
0.9	0.327	-55.0	1.74	-92.4	0.014	51.7	0.224	-31.0	17.37	4.8
1.0	0.328	-60.3	1.67	-104.2	0.015	50.2	0.215	-33.1	16.95	4.5
1.1	0.328	-66.2	1.60	-113.8	0.017	48.7	0.207	-36.1	15.66	4.1
1.2	0.329	-70.9	1.54	-121.2	0.019	47.3	0.199	-36.5	14.60	3.8
1.3	0.328	-76.7	1.48	-130.0	0.021	45.8	0.194	-39.8	13.78	3.4
1.4	0.324	-81.9	1.42	-138.9	0.021	44.3	0.189	-39.9	14.43	3.0
1.5	0.318	-87.2	1.36	-146.6	0.022	42.8	0.185	-41.3	14.47	2.7
1.6	0.311	-92.6	1.29	-154.5	0.022	41.3	0.181	-42.9	15.36	2.2
1.7	0.302	-99.0	1.22	-162.7	0.022	39.9	0.177	-44.2	16.36	1.7
1.8	0.288	-103.8	1.16	-168.3	0.021	38.4	0.172	-45.6	18.23	1.3
1.9	0.267	-109.8	1.10	-176.1	0.020	36.9	0.166	-47.2	20.49	0.8
2.0	0.243	-116.2	1.04	176.8	0.019	35.4	0.156	-48.5	23.20	0.3

Note:

1. K Factor Calculation:

$$K = \frac{1 + |\Delta|^2 - |S_{11}|^2 - |S_{22}|^2}{2 |S_{12} S_{21}|}, \Delta = S_{11} S_{22} - S_{21} S_{12}$$

OUTLINE DIMENSIONS (Units in mm)

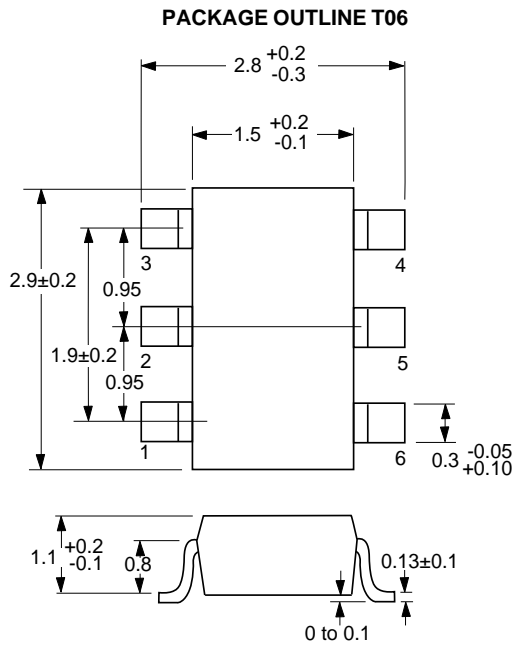

Note:
All dimensions are typical unless otherwise specified.

EQUIVALENT CIRCUIT

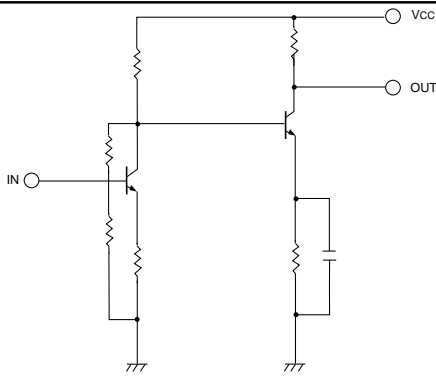

ORDERING INFORMATION

PART NUMBER	QTY
UPC2747T-E3	3K/Reel

Note:
Embossed Tape, 8 mm wide.

LEAD CONNECTIONS

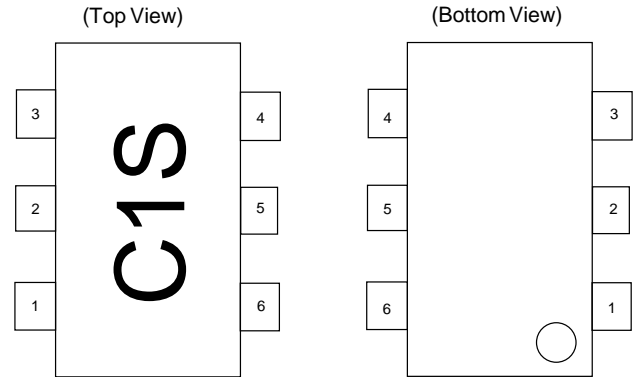

1. INPUT
2. GND
3. GND
4. OUTPUT
5. GND
6. Vcc

RECOMMENDED P.C.B. LAYOUT (Units in mm)

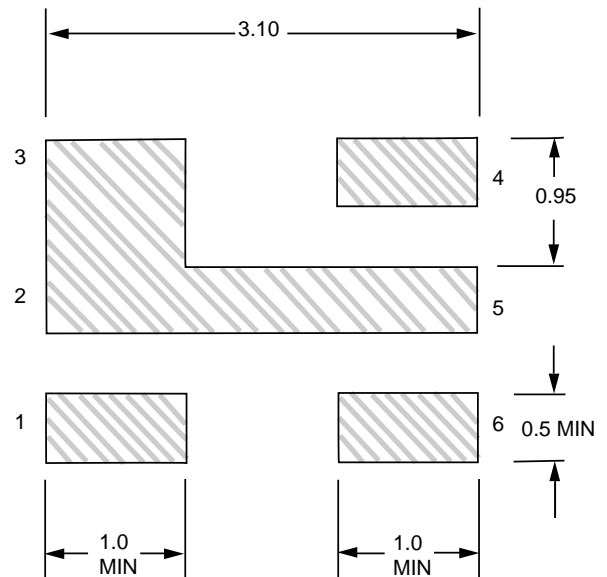

EXCLUSIVE NORTH AMERICAN AGENT FOR **NEC** RF, MICROWAVE & OPTOELECTRONIC SEMICONDUCTORS

CEL CALIFORNIA EASTERN LABORATORIES • Headquarters • 4590 Patrick Henry Drive • Santa Clara, CA 95054-1817 • (408) 988-3500 • Telex 34-6393 • FAX (408) 988-0279
24-Hour Fax-On-Demand: 800-390-3232 (U.S. and Canada only) • Internet: <http://WWW.CEL.COM>

DATA SUBJECT TO CHANGE WITHOUT NOTICE

PRINTED IN USA ON RECYCLED PAPER -3/97