

5.6 Watt 3.5GHz Packaged HPA



Key Features

- 3.5 GHz Application Frequency Range
- 11 dB Nominal Gain
- 2.5%EVM @29dBm OFDM signal at 3.5GHz
- 37.5 dBm Nominal Psat
- Internally Partially Matched
- IMD3 -50 dBc @ 24 dBm SCL, Typical
- Bias Conditions: 8 V @ 0.75 A (Quiescent)
- 0.5 μm HFET Technology
- 2 lead Cu-alloy base package

Primary Applications

- 802.16 and WiMax
- S-Band Power Amplifiers

Product Description

The TGA2925-SG HPA provides 11 dB of gain, 5.6 W of output power at 3.5 GHz and 2.5% EVM at 29 dBm output power. The device is ideally suited for high linearity, high power wireless data applications such as 802.16 and WiMax. The package has a high thermal conductivity copper alloy base. Internal partial matching simplifies system board layout by requiring a minimum of external components.

Lead-Free & RoHS compliant.

Evaluation Boards are available.

Measured Performance

Bias Conditions: $V_d = 8\text{ V}$, $I_{dq} = 0.75\text{ A}$

Performance data taken in a 3.5 GHz application circuit

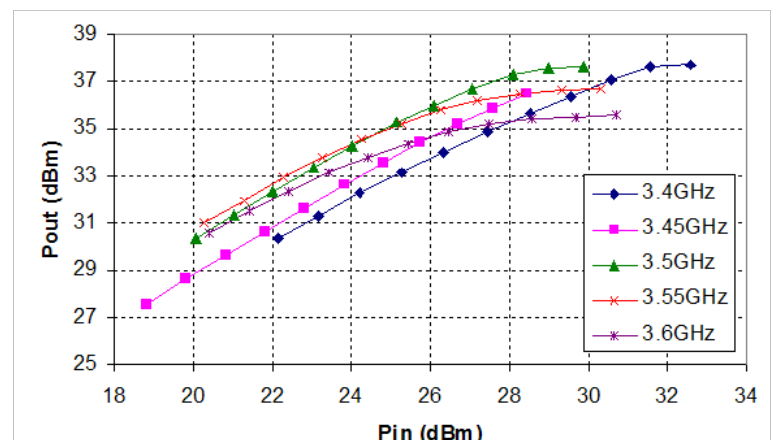
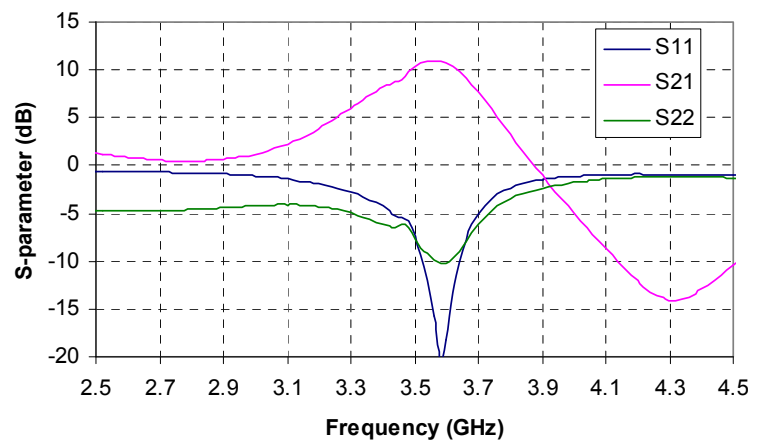

**TABLE I
MAXIMUM RATINGS 1/**

Symbol	Parameter	Value	Notes
V _d	Drain Supply Voltage	10 V	<u>2/</u>
V _g	Gate Supply Voltage Range	-0.5 V to -5 V	
I _{dq}	Drain Supply Current (Quiescent)	2.1 A	<u>2/</u>
I _g	Gate Current	30 mA	
P _{IN}	Input Continuous Wave Power	35 dBm	<u>2/</u>
P _D	Power Dissipation	9.4 W	<u>2/</u> , <u>3/</u>
T _{CH}	Operating Channel Temperature	200 °C	<u>4/</u>
	Mounting Temperature (6-10 Seconds)	260 °C	
T _{STG}	Storage Temperature	-65 to 150 °C	

- 1/ These ratings represent the maximum operable values for this device.
- 2/ Combinations of supply voltage, supply current, input power, and output power shall not exceed P_D.
- 3/ When operated at this bias condition with a base plate temperature of 85 °C, the median life is 7.5E5 hours.
- 4/ Junction operating temperature will directly affect the device median time to failure (T_m). For maximum life, it is recommended that junction temperatures be maintained at the lowest possible levels.

TABLE II
RF CHARACTERIZATION TABLE
 (T_A = 25°C, Nominal)
 (V_d = 8 V, I_{dq} = 0.75 A)

SYMBOL	PARAMETER	TEST CONDITION	TYPICAL	UNITS
Gain	Small Signal Gain	f = 3.5 GHz	11	dB
IRL	Input Return Loss	f = 3.5 GHz	10	dB
ORL	Output Return Loss	f = 3.5 GHz	8	dB
Psat	Saturated Output Power		37.5	dBm

**TABLE III
THERMAL INFORMATION**

Parameter	Test Conditions	T _{CH} (°C)	θ _{JC} (°C/W)	T _m (HRS)
θ _{JC} Thermal Resistance (channel to backside of package)	V _d = 8 V I _D = 0.75 A P _{diss} = 6 W	158	12.2	5.5E+7

Note: Package backside SnPb soldered to carrier at 85 °C baseplate temperature. At saturated output power, the DC power consumption is 13.2W with 5.6W RF power delivered to the load and 7.6W dissipated.

Median Lifetime (T_m) vs. Channel Temperature

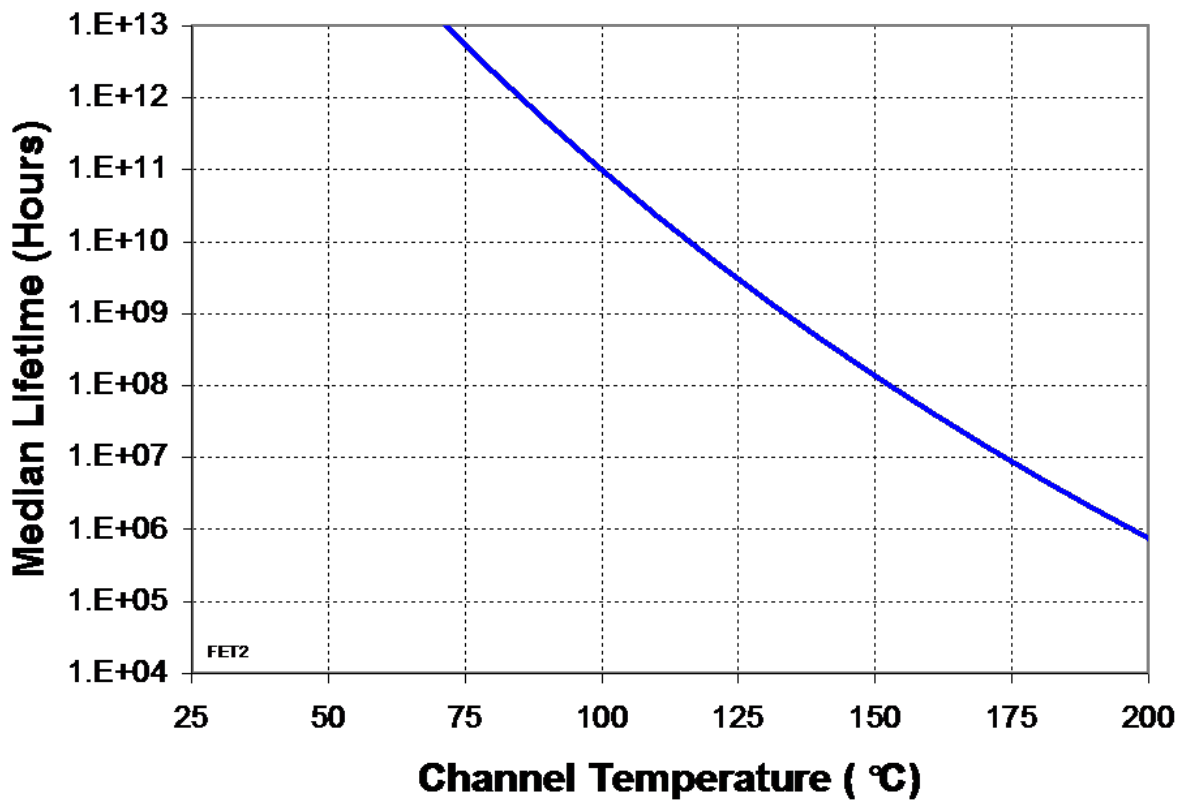

**TGA2925 Measured Fixtured Data
Application Circuit tuned to 3.5 GHz**

Bias Conditions: $V_d = 8\text{ V}$, $I_{dq} = 0.75\text{ A}$

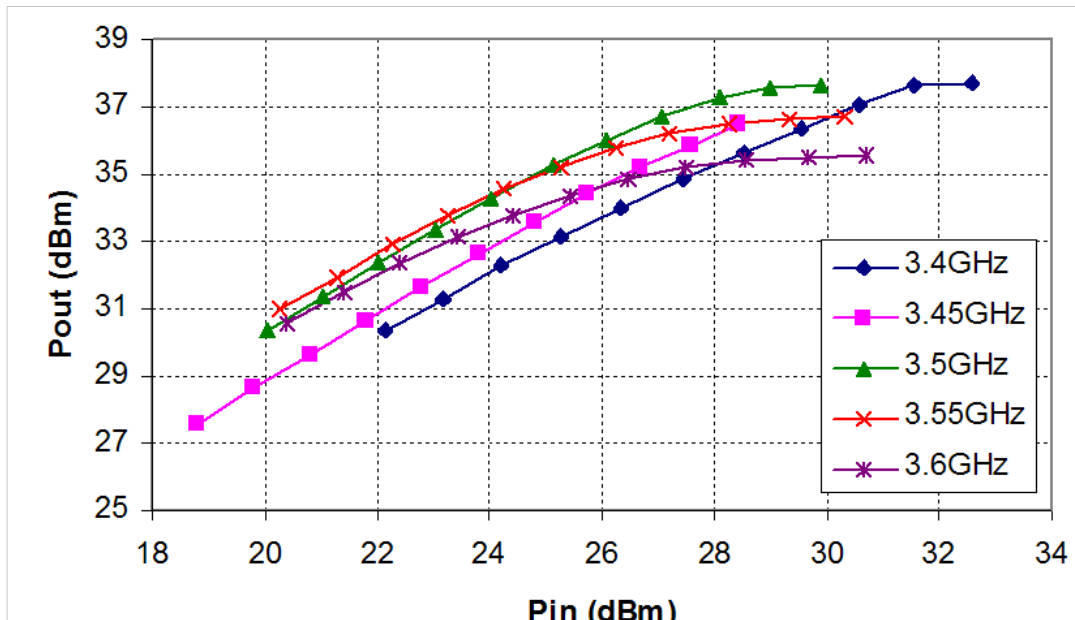
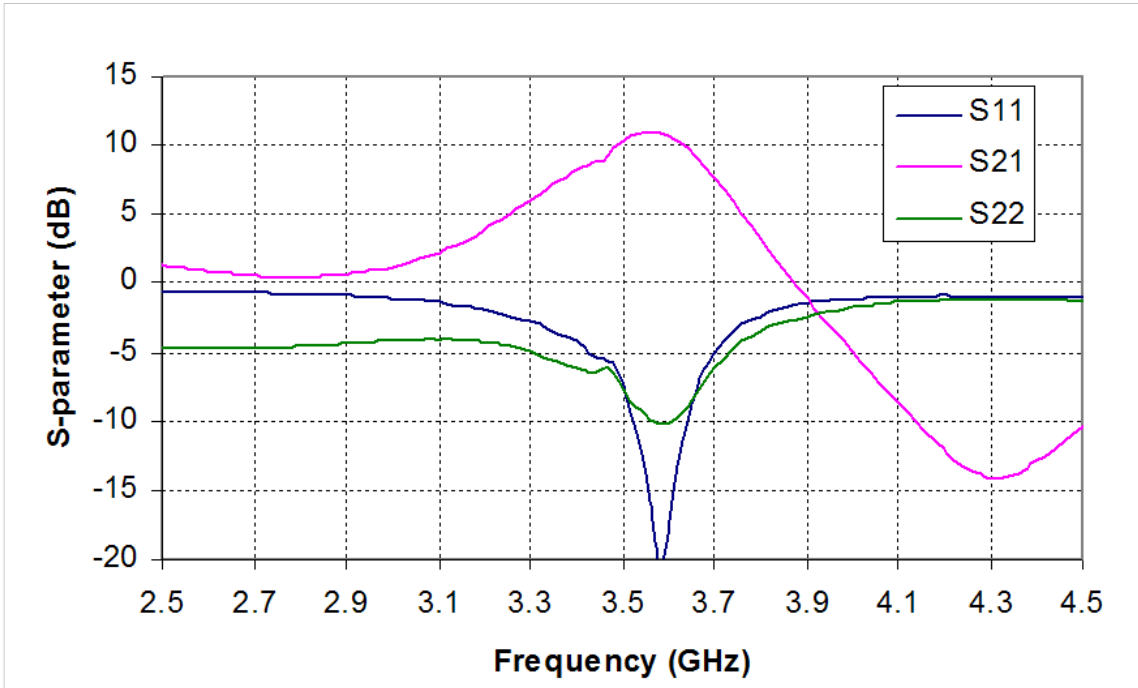

TGA2925 Measured Fixtured Data
Application Circuit tuned to 3.5 GHz

Bias Conditions: $V_d = 8\text{ V}$, $I_{dq} = 0.75\text{ A}$

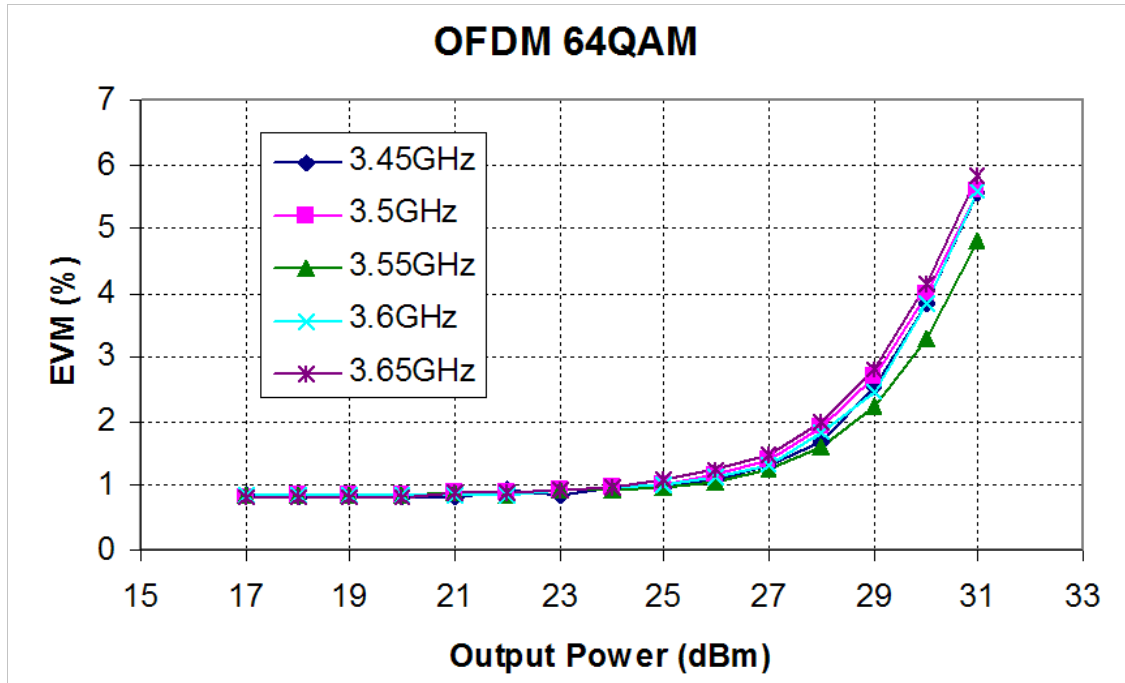

**TGA2925 Measured Fixtured Data
Application Circuit tuned to 3.5 GHz**

Bias Conditions: $V_d = 8\text{ V}$, $I_{dq} = 0.75\text{ A}$

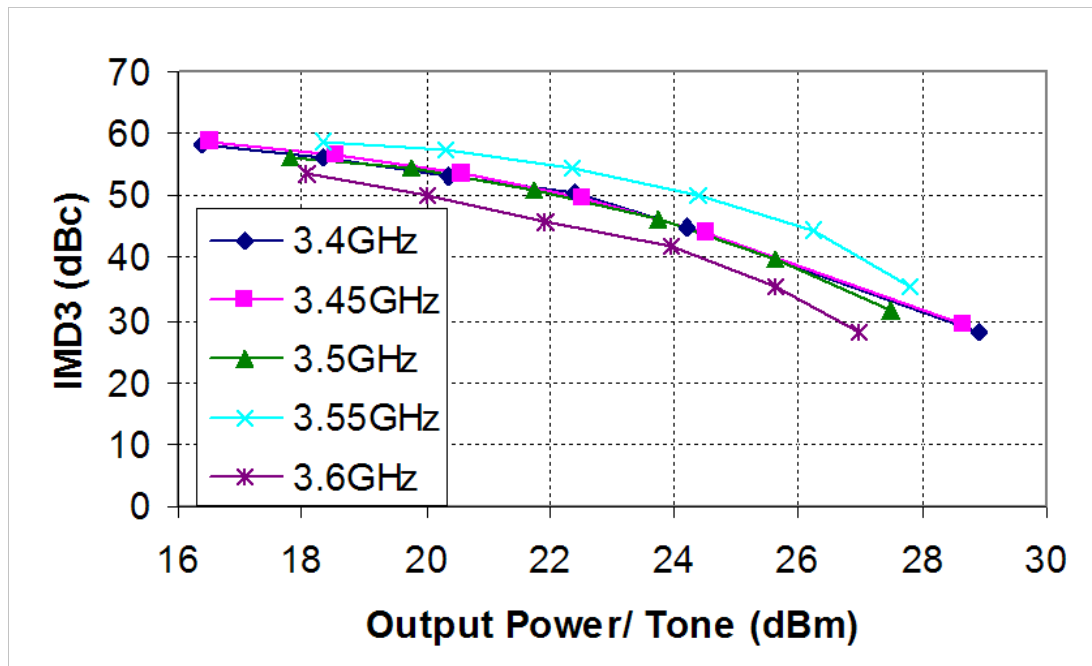
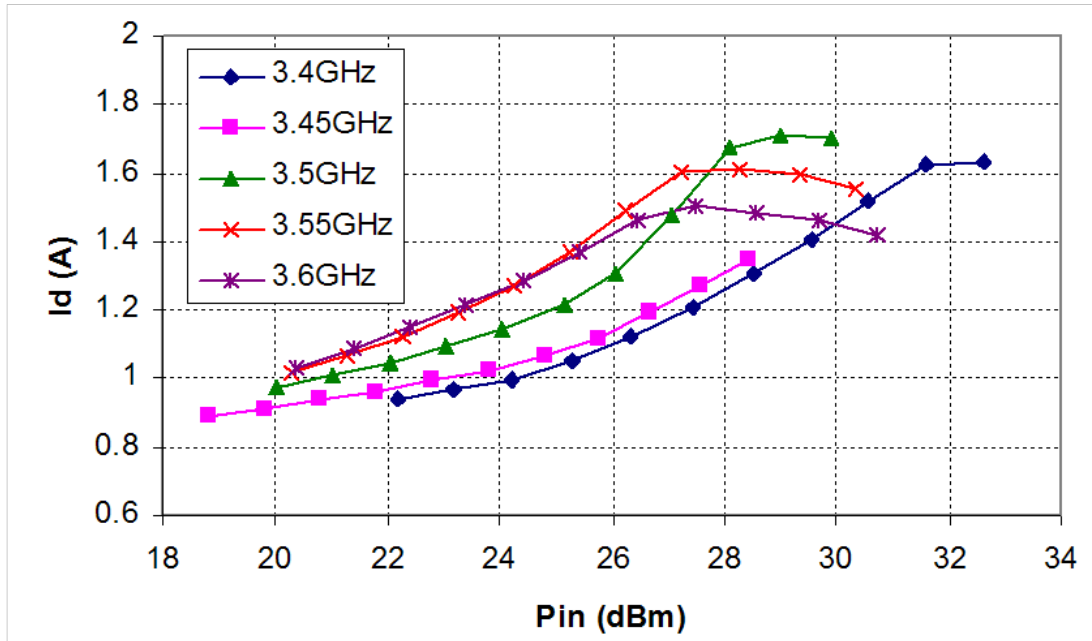

Mechanical Drawing

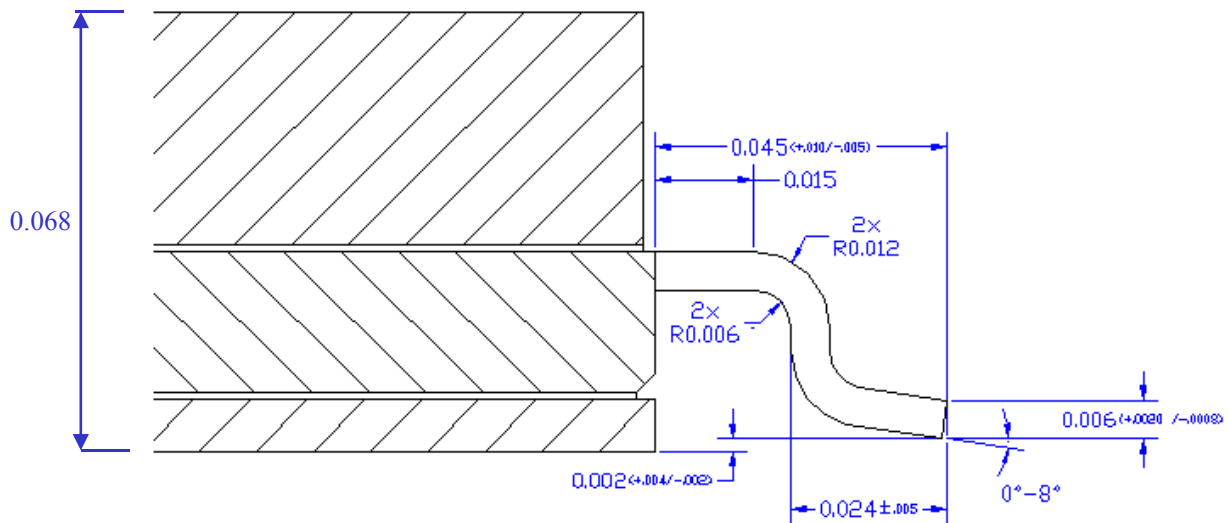
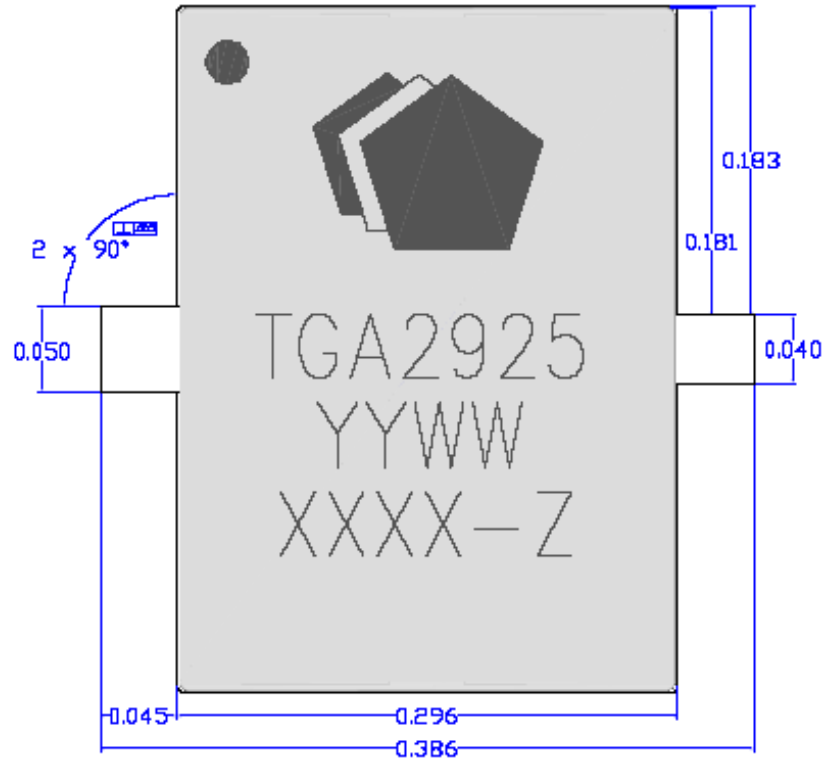

Note: All dimensions are in inches with ± 5 mil tolerance

3.5 GHz Application Circuit Schematic

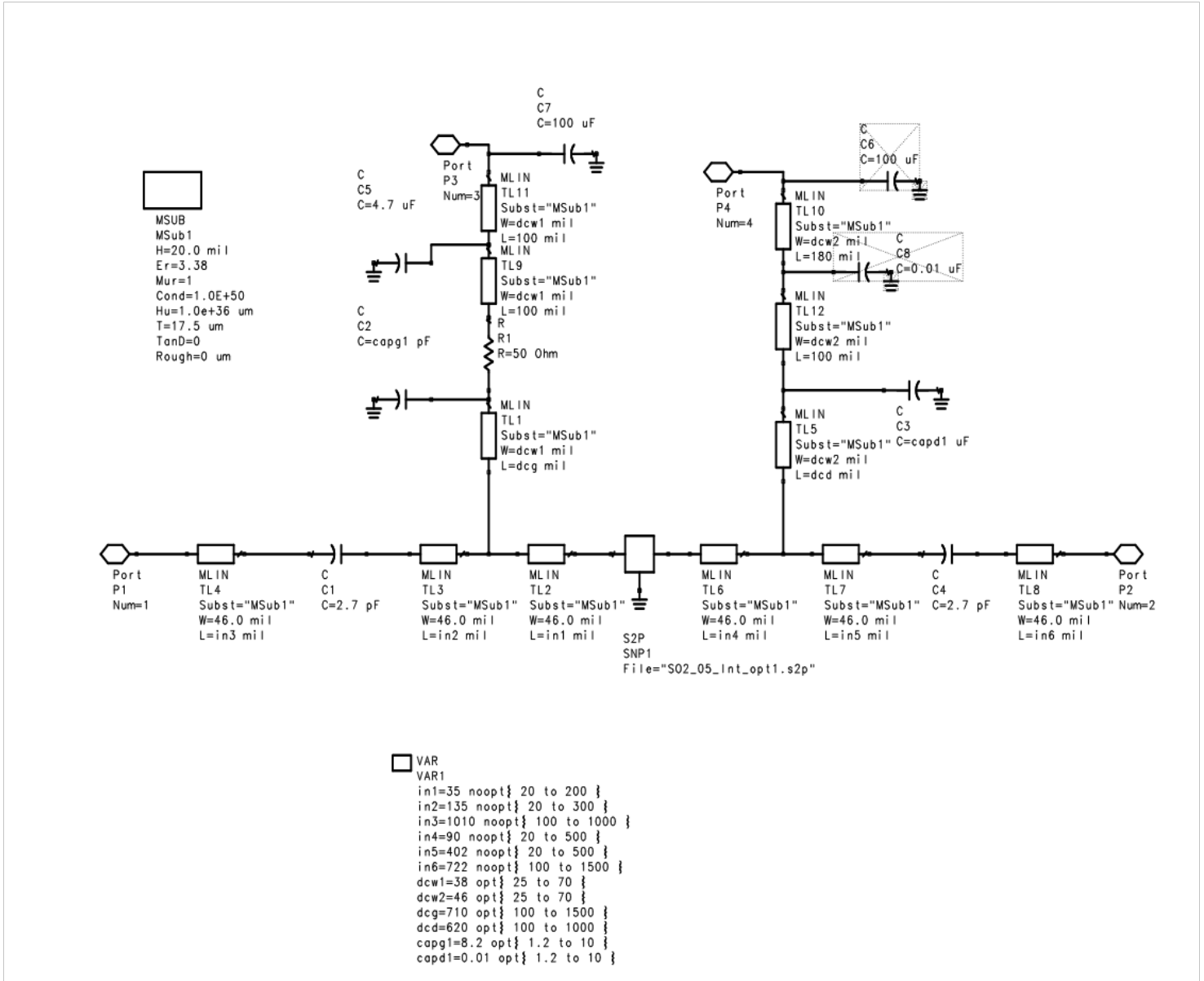

PCB is 20 mil thick Rogers 4003 substrate

Bias Procedure

1. Ensure no RF power is applied to the device.
2. Pinch off device by setting Vg to -3V.
3. Increase Vd to 8.0V while monitoring drain current.
4. Increase Vg until drain current reaches 0.75A
5. Apply RF power.

Typical Evaluation Board Layout *

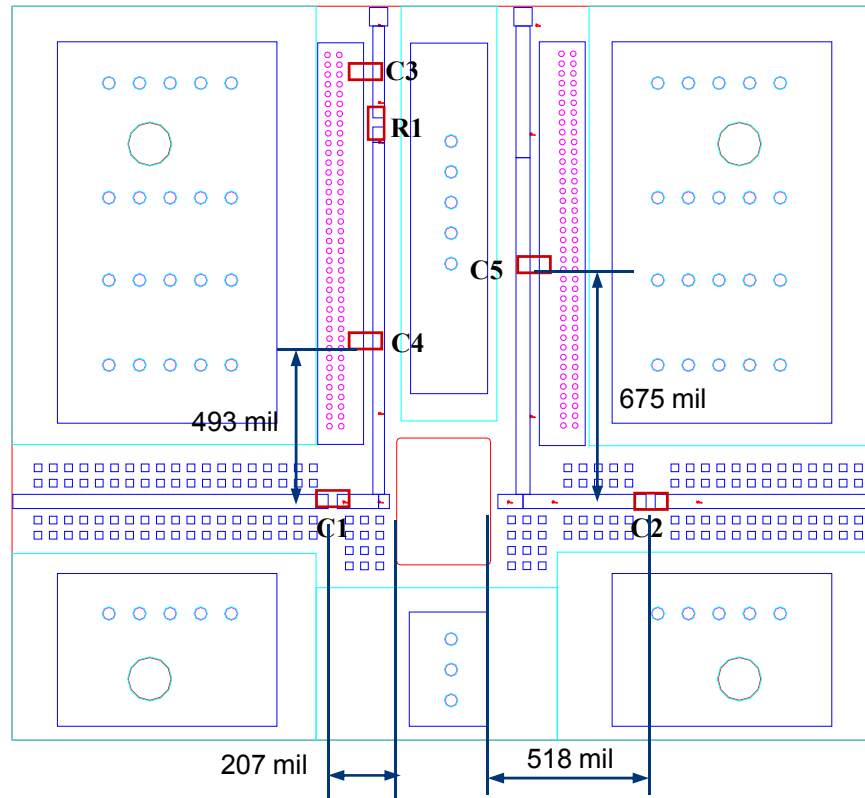

*The layout is a general purpose drawing that needs to be tuned for the specific application.
PCB is RO4003 20 mil thickness, 0.5 oz standard copper cladding, with $\epsilon_r = 3.38$.

External Component Listing

Part Type	Reference	Description
Capacitor	C1	AVX 06035J5R6BBT, 2.7 pF
Capacitor	C2	AVX 06035J5R6BBT, 2.7 pF
Capacitor	C3	4.7uF
Capacitor	C4	AVX 06035J8R2BBT, 8.2 pF
Capacitor	C5	0.01 uF
Resistor	R1	0805, 50 Ω

Contact TriQuint Applications Engineering for additional info

Recommended Surface Mount Package Assembly

Proper ESD precautions must be followed while handling packages.

Clean the board with acetone. Rinse with alcohol. Allow the circuit to fully dry.

TriQuint recommends using a conductive solder paste for attachment. Follow solder paste and reflow oven vendors' recommendations when developing a solder reflow profile. Typical solder reflow profiles are listed in the table below.

Hand soldering is not recommended. Solder paste can be applied using a stencil printer or dot placement. The volume of solder paste depends on PCB and component layout and should be well controlled to ensure consistent mechanical and electrical performance.

Clean the assembly with alcohol.

Typical Solder Reflow Profiles

Reflow Profile	SnPb	Pb Free
Ramp-up Rate	3 °C/sec	3 °C/sec
Activation Time and Temperature	60 – 120 sec @ 140 – 160 °C	60 – 180 sec @ 150 – 200 °C
Time above Melting Point	60 – 150 sec	60 – 150 sec
Max Peak Temperature	240 °C	260 °C
Time within 5 °C of Peak Temperature	10 – 20 sec	10 – 20 sec
Ramp-down Rate	4 – 6 °C/sec	4 – 6 °C/sec

Ordering Information

Part	Package Style
TGA2925-SG	Gull Wing Leads