

## 1.5/1.9GHz BAND LOW NOISE AMPLIFIER GaAs MMIC

### ■GENERAL DESCRIPTION

NJG1107KB2 is a Low Noise Amplifier GaAs MMIC designed for 1.5GHz and 1.9GHz band digital cellular phone and Japanese PHS handsets. This amplifier provides low noise figure, high gain and high IP3 operated by single low positive power supply.

This amplifier includes internal self-bias circuit and input DC blocking capacitor.

An ultra small and ultra thin package of FLP6 is adopted.

### ■PACKAGE OUTLINE



NJG1107KB2

### ■FEATURES

- Low voltage operation +2.7V typ.
- Low current consumption 3.0mA typ.
- High small signal gain 17dB typ. @f=1.49GHz  
15dB typ. @f=1.96GHz
- Low noise figure 1.2dB typ. @f=1.49GHz  
1.2dB typ. @f=1.96GHz
- High Input IP3 -4.0dBm typ. @f=1.4900+1.4901GHz  
-2.0dBm typ. @f=1.9600+1.9601GHz
- Ultra small & ultra thin package FLP6-B2 (Mount Size: 2.1x2.0x0.75mm)
- This amplifier can be tuned into various frequency range.(Best for 1.5GHz or 1.9GHz Band)

### ■PIN CONFIGURATION

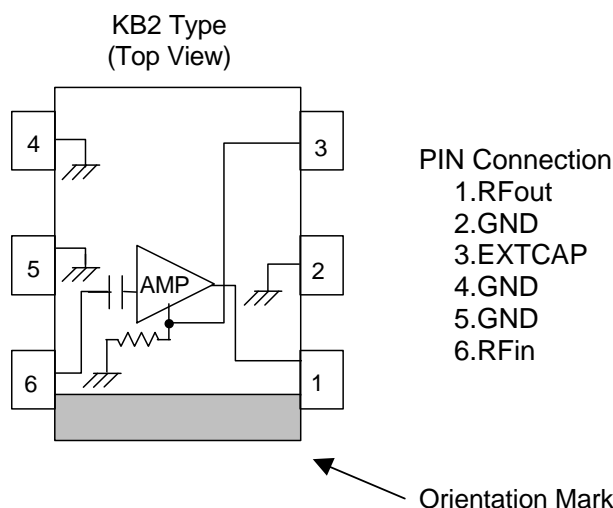

Note: Specifications and description listed in this catalog are subject to change without prior notice.

# NJG1107KB2

## ■ABSOLUTE MAXIMUM RATINGS

( $T_a=+25^{\circ}\text{C}$ ,  $Z_s=Z_l=50\Omega$ )

PARAMETER	SYMBOL	CONDITIONS	RATINGS	UNIT
Drain Voltage	$V_{DD}$		6.0	V
Input Power	$P_{in}$	$V_{DD}=2.7\text{V}$	+15	dBm
Power Dissipation	$P_D$		450	mW
Operating Temp.	$T_{opr}$		-40~+85	$^{\circ}\text{C}$
Storage Temp.	$T_{stg}$		-55~+125	$^{\circ}\text{C}$

## ■ELECTRICAL CHARACTERISTICS 1 (1.5GHz Band)

( $V_{DD}=2.7\text{V}$ ,  $f=1.49\text{GHz}$ ,  $T_a=+25^{\circ}\text{C}$ ,  $Z_s=Z_l=50\Omega$ , TEST CIRCUIT1)

PARAMETER	SYMBOL	CONDITIONS	MIN	TYP	MAX	UNIT
Operating Frequency	freq1		1.47	1.49	1.51	GHz
Drain Voltage	$V_{DD}$		2.5	2.7	5.5	V
Operating Current	$I_{DD}$	RF OFF	-	3.0	3.8	mA
Small Signal Gain	Gain		15.0	17.0	19.0	dB
Gain Flatness	$G_{flat}$	$f=1.47\sim 1.51\text{GHz}$	-	0.5	1.0	dB
Noise Figure	NF		-	1.2	1.4	dB
Pout at 1dB Gain Compression point	$P_{-1dB}$		-6.0	-2.0	-	dBm
Input 3rd Order Intercept Point	IIP3	$f=1.49+1.4901\text{GHz}$ RFIn=-35dBm	-6.0	-4.0	-	dBm
RF Input Port VSWR	$VSWR_i$		-	1.6	2.2	
RF Output Port VSWR	$VSWR_o$			1.6	2.2	

## ■ELECTRICAL CHARACTERISTICS 2 (1.9GHz Band)

( $V_{DD}=2.7\text{V}$ ,  $f=1.96\text{GHz}$ ,  $T_a=+25^{\circ}\text{C}$ ,  $Z_s=Z_l=50\Omega$ , TEST CIRCUIT1)

PARAMETER	SYMBOL	CONDITIONS	MIN	TYP	MAX	UNIT
Operating Frequency	freq2		1.89	1.96	1.99	GHz
Drain Voltage	$V_{DD}$		2.5	2.7	5.5	V
Operating Current	$I_{DD}$	RF OFF	-	3.0	3.8	mA
Small Signal Gain	Gain		13.0	15.0	17.0	dB
Gain Flatness	$G_{flat}$	$f=1.89\sim 1.99\text{GHz}$	-	0.5	1.0	dB
Noise Figure	NF		-	1.2	1.4	dB
Pout at 1dB Gain Compression point	$P_{-1dB}$		-3.0	+1.0	-	dBm
Input 3rd order Intercept Point	IIP3	$f=1.96+1.9601\text{GHz}$ RFIn=-30dBm	-6.0	-2.0	-	dBm
RF Input Port VSWR	$VSWR_i$		-	1.6	2.2	
RF Output Port VSWR	$VSWR_o$		-	1.6	2.2	

## ■ELECTRICAL CHARACTERISTICS 3 (1.8GHz Band)

( $V_{DD}=2.7V$ ,  $f=1.76GHz$ ,  $T_a=+25^{\circ}C$ ,  $Z_s=Z_l=50\Omega$ , TEST CIRCUIT1)

PARAMETER	SYMBOL	CONDITIONS	MIN	TYP	MAX	UNIT
Operating Frequency	freq3		1.75	1.76	1.78	GHz
Drain Voltage	$V_{DD}$		2.5	2.7	5.5	V
Operating Current	$I_{DD}$	RF OFF	-	3.0	3.8	mA
Small Signal Gain	Gain		-	16.0	-	dB
Gain Flatness	$G_{flat}$	$f=1.75\sim 1.78GHz$	-	0.5	-	dB
Noise Figure	NF		-	1.2	-	dB
Pout at 1dB Compression point	$P_{-1dB}$		-	1.1	-	dBm
Input 3rd order Intercept Point	IIP3	$f=1.76+1.7601GHz$ RFIn=-35dBm	-	-2.0	-	dBm
RF Input Port VSWR	$VSWR_i$		-	1.6	-	-
RF Output Port VSWR	$VSWR_o$		-	1.6	-	-

## ■ELECTRICAL CHARACTERISTICS 4 (1.5GHz Band ,Low Gain Version)

( $V_{DD}=2.7V$ ,  $f=1.49GHz$ ,  $T_a=+25^{\circ}C$ ,  $Z_s=Z_l=50\Omega$ , TEST CIRCUIT2)

PARAMETER	SYMBOL	CONDITIONS	MIN	TYP	MAX	UNIT
Operating Frequency	freq4		1.47	1.49	1.51	GHz
Drain Voltage	$V_{DD}$		2.5	2.7	5.5	V
Operating Current	$I_{DD}$	RF OFF	-	3.0	3.8	mA
Small Signal Gain	Gain		-	14.0	-	dB
Gain Flatness	$G_{flat}$	$f=1.47\sim 1.51GHz$	-	0.5	-	dB
Noise Figure	NF		-	1.2	-	dB
Pout at 1dB Compression point	$P_{-1dB}$		-	0.0	-	dBm
Input 3rd order Intercept Point	IIP3	$f=1.49+1.4901GHz$ RFIn=-35dBm	-	-3.0	-	dBm
RF Input Port VSWR	$VSWR_i$		-	1.6	-	
RF Output Port VSWR	$VSWR_o$		-	1.6	-	

# NJG1107KB2

---

## ■PIN CONFIGURATION

Pin	Function	Description
1	RFout	RF output and voltage supply pin. External matching circuits and a bypass capacitor is required. L3 is a RF choke inductor and C1 is a DC blocking capacitor. These elements are used as output matching circuit. C2 is a bypass capacitor. (Please refer to "TEST CIRCUIT")
2,4,5	GND	Ground pin. To keep good RF grounding performance, please use multiple via holes to connect with ground plane and this pin.
3	EXTCAP	An external bypass capacitor is required. (Please refer to "TEST CIRCUIT")
6	RFin	RF input pin. A DC blocking capacitor is not required. An external matching circuit is required. (Please refer to "TEST CIRCUIT")

## TYPICAL CHARACTERISTICS (1.5GHz Band)

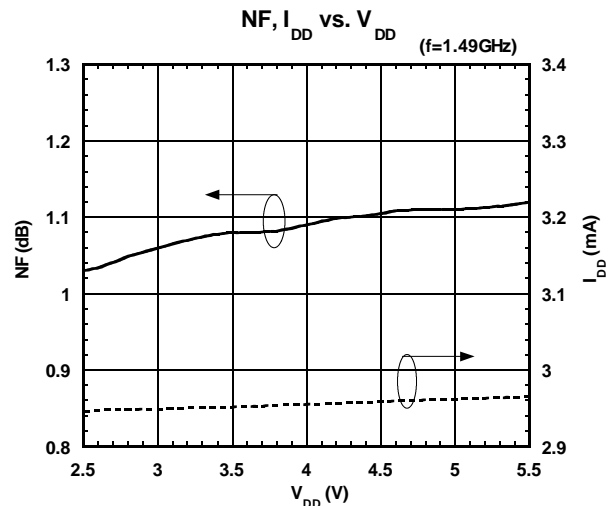
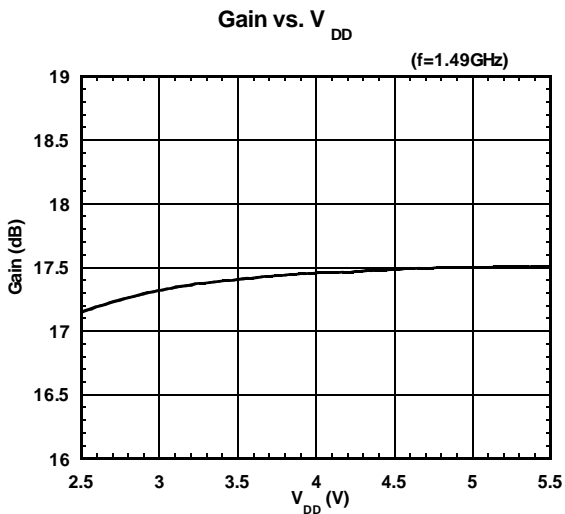
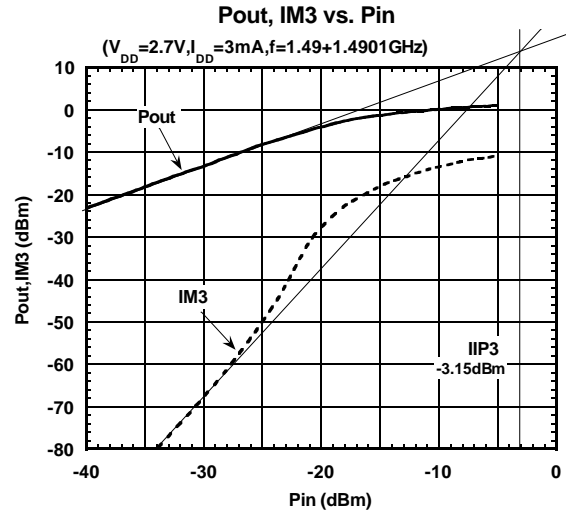
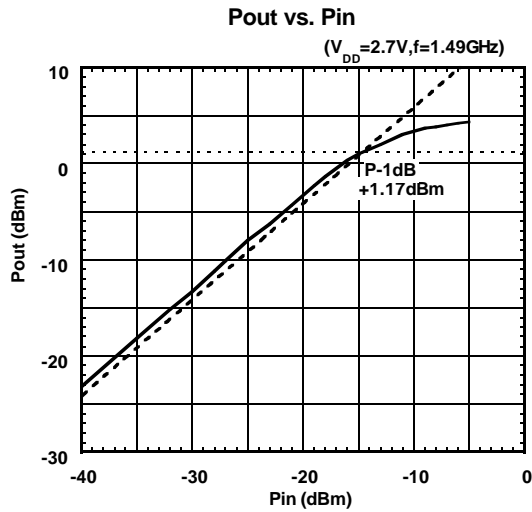
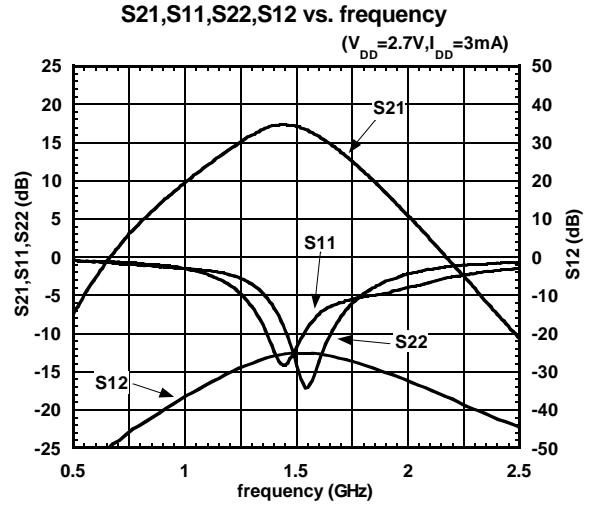
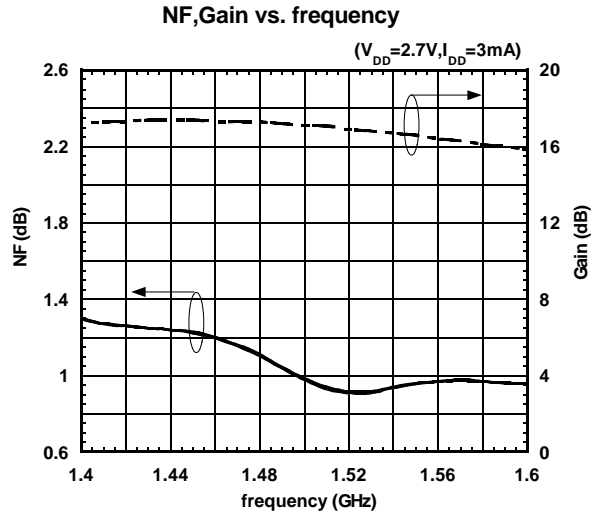

# NJG1107KB2

## TYPICAL CHARACTERISTICS (1.5GHz Band)

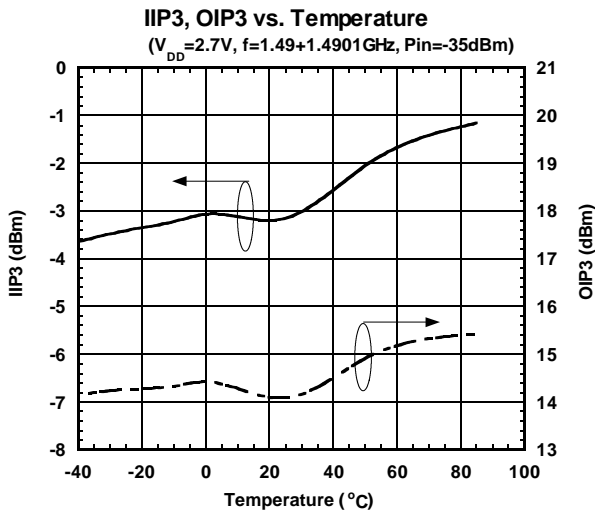
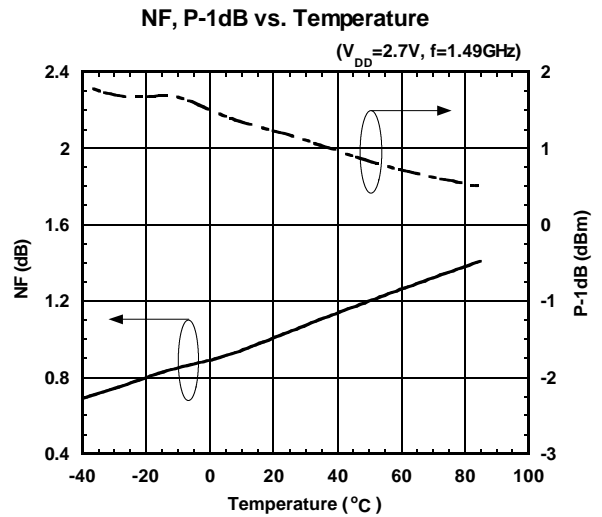
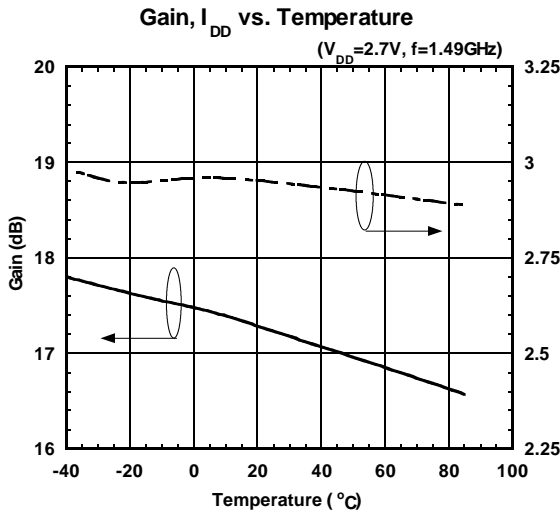
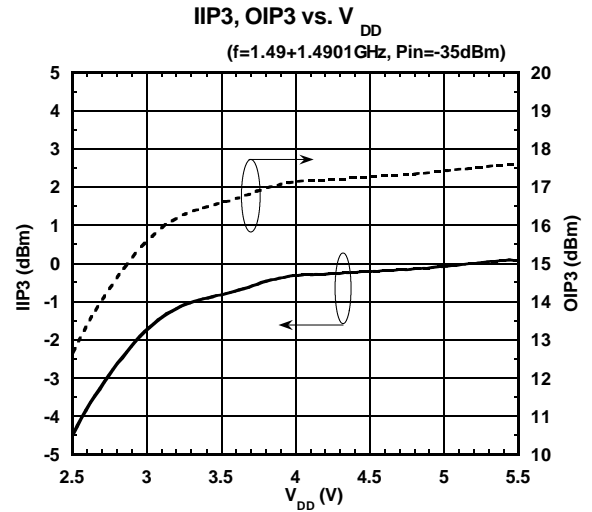
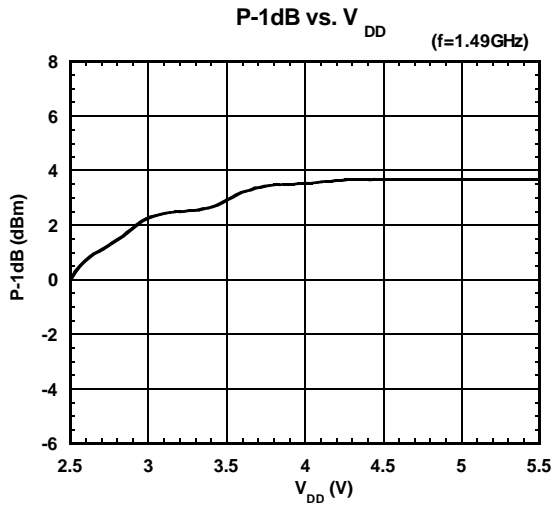

Equations of OIP3 and IIP3

$$OIP3 = \frac{3 \times P_{out} - IM3}{2}$$

$$IIP3 = OIP3 - Gain \quad @ Pin = -35dBm$$

## ■ TYPICAL CHARACTERISTICS (1.5GHz Band)

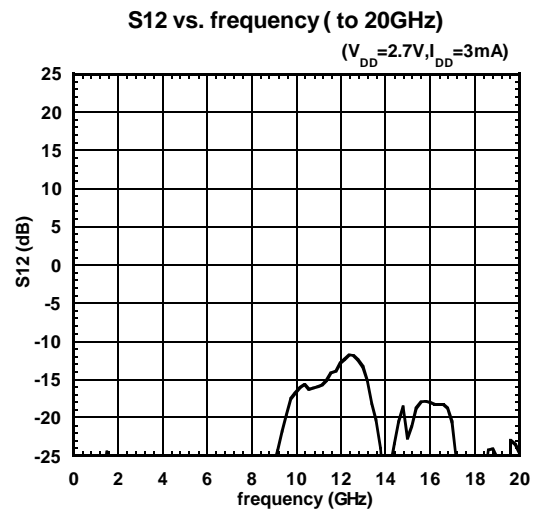
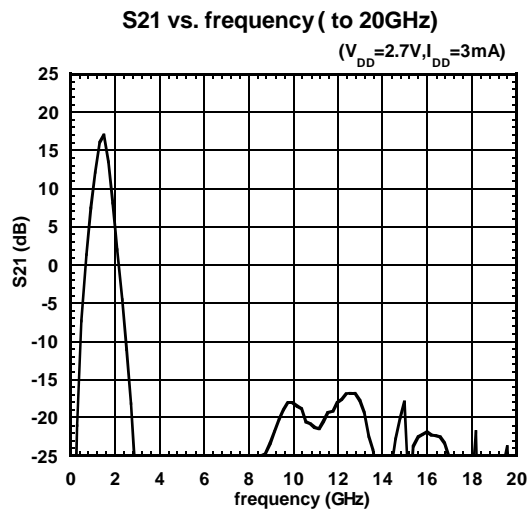
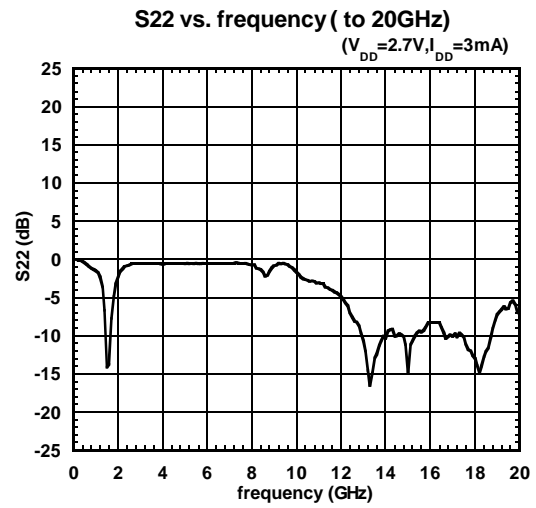
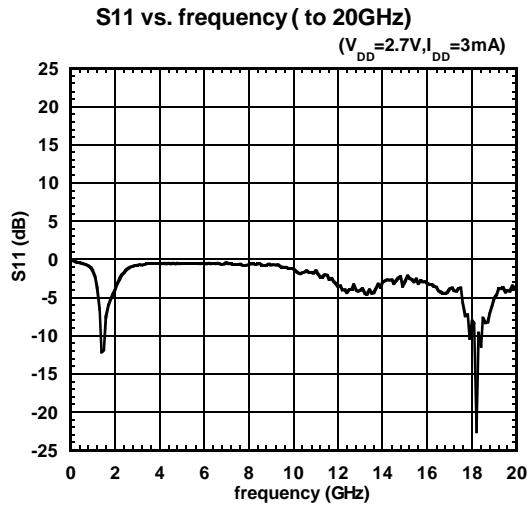

# NJG1107KB2

## TYPICAL CHARACTERISTICS (1.9GHz Band)

NF, Gain vs. frequency

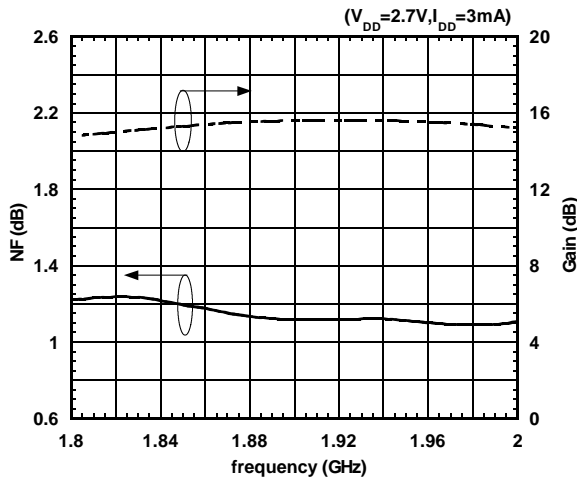

S21, S11, S22, S12 vs. frequency

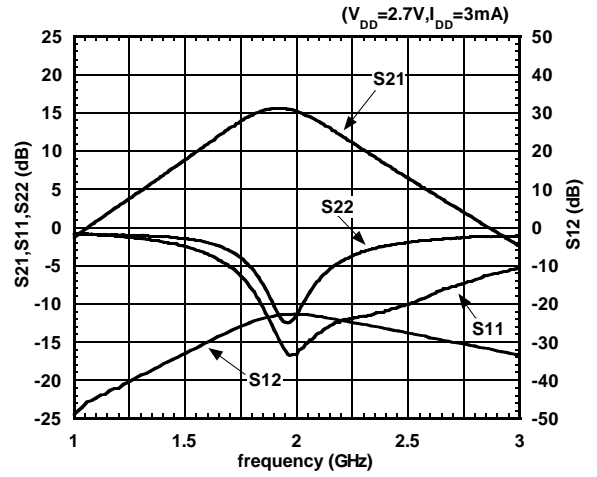

Pout vs. Pin

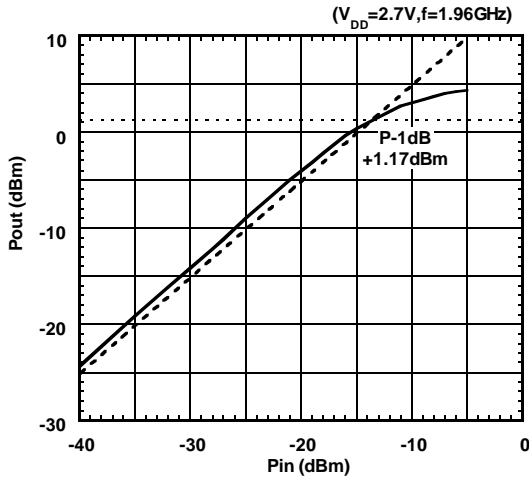

Pout, IM3 vs. Pin

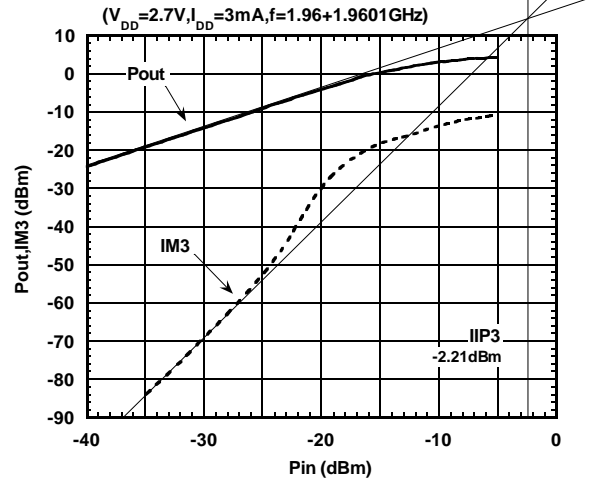

Gain vs.  $V_{DD}$

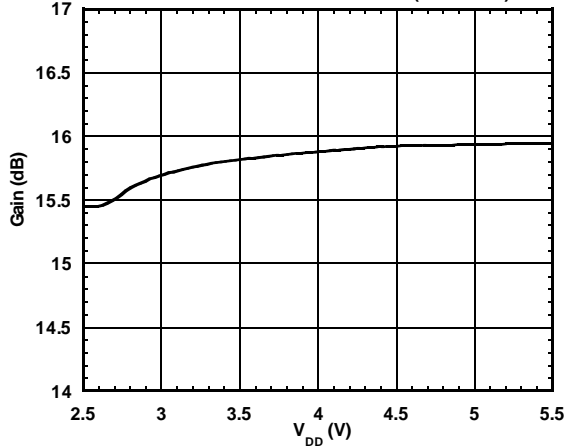

NF,  $I_{DD}$  vs.  $V_{DD}$

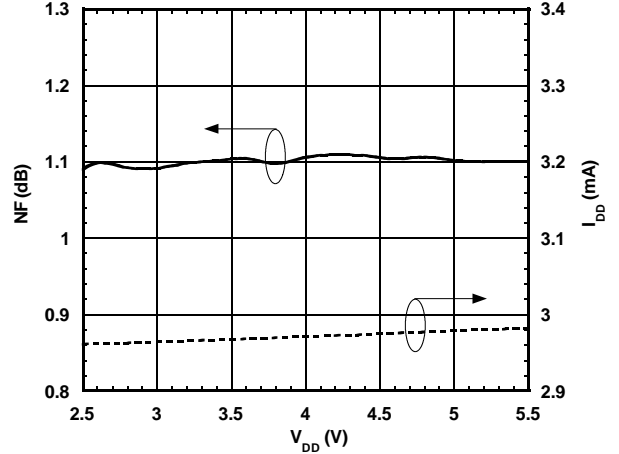



## TYPICAL CHARACTERISTICS (1.9GHz Band)

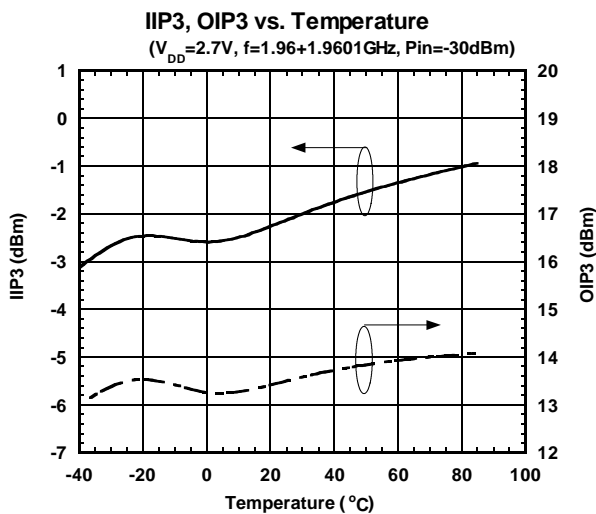
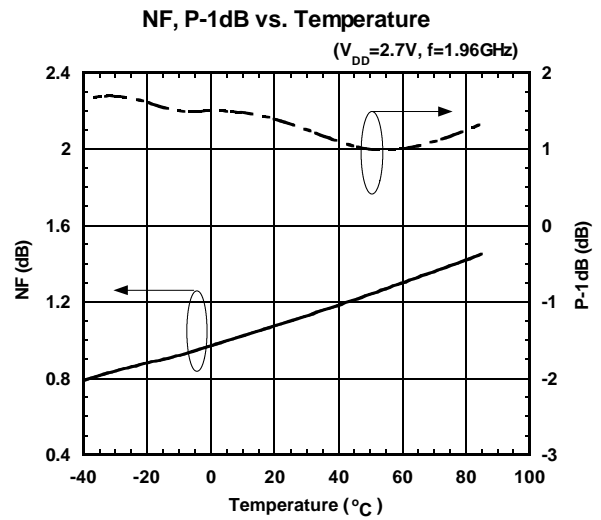
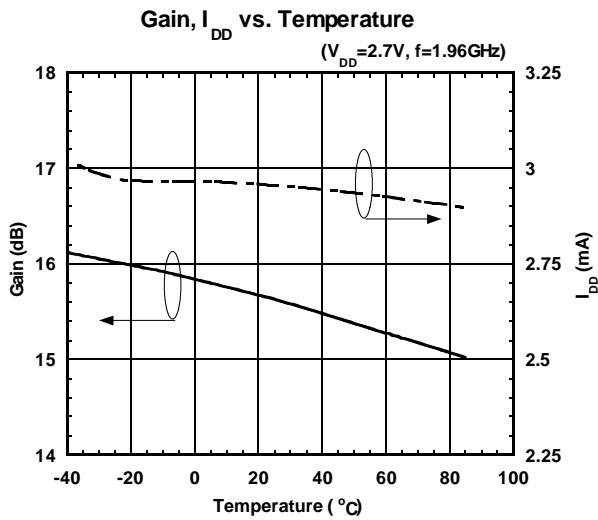
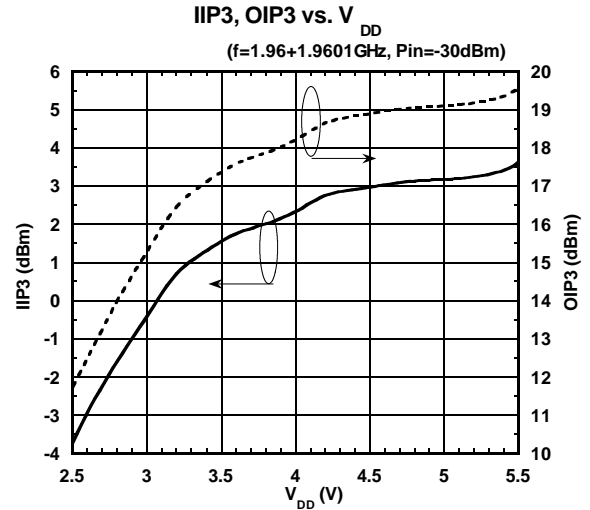
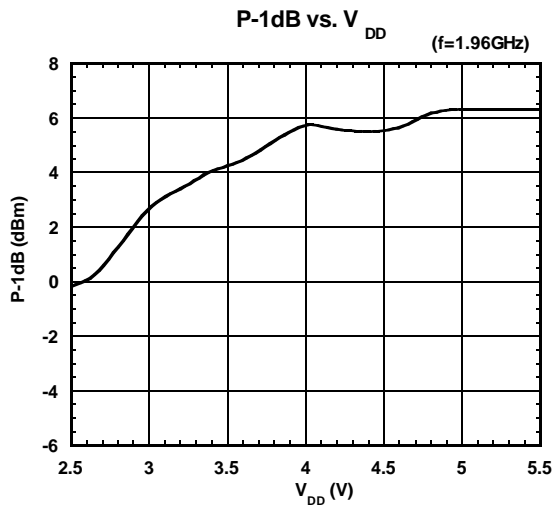

Equations of OIP3 and IIP3

$$OIP3 = \frac{3 \times P_{out} - IM3}{2}$$

$$IIP3 = OIP3 - Gain \quad @ \text{ Pin} = -30\text{dBm}$$

# NJG1107KB2

## ■TYPICAL CHARACTERISTICS (1.9GHz Band)

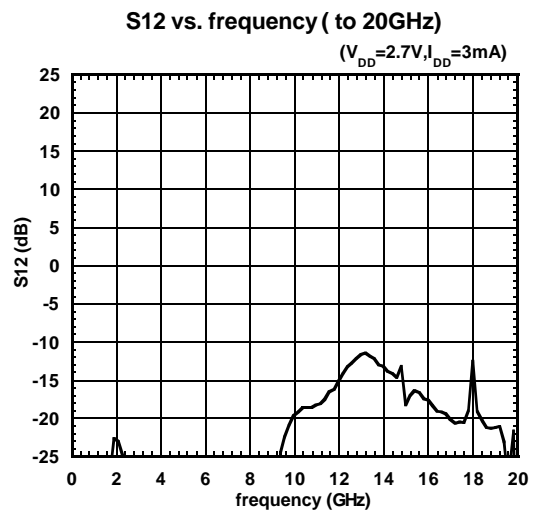
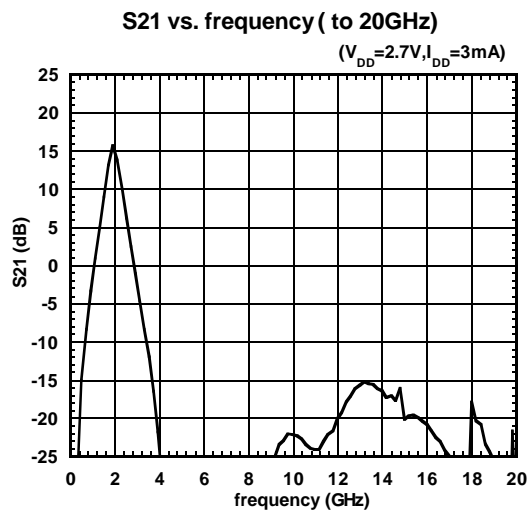
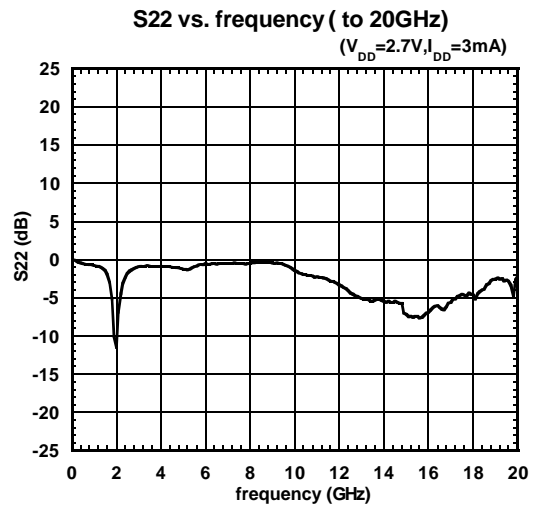
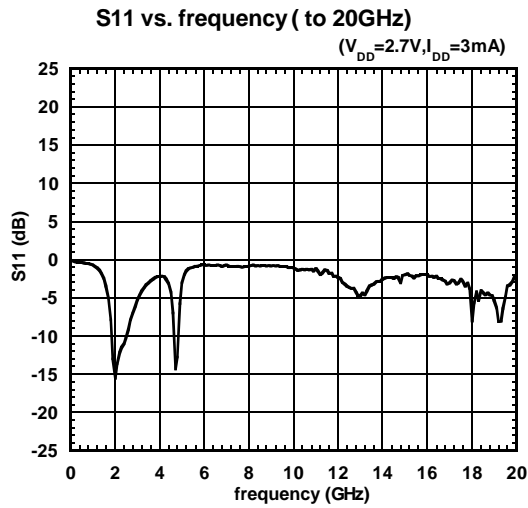

## TYPICAL CHARACTERISTICS (1.8GHz Band)

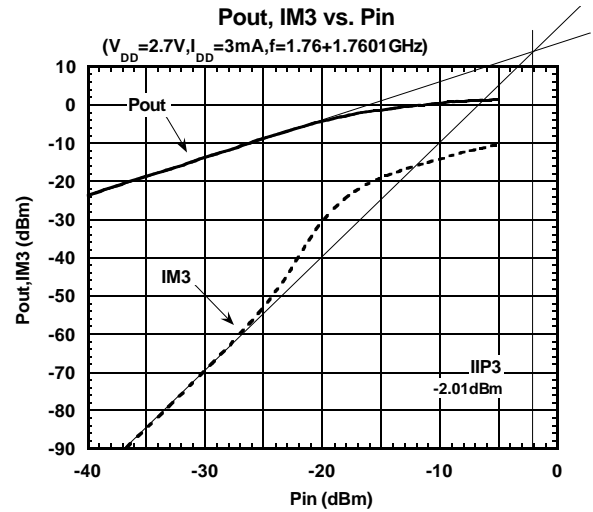
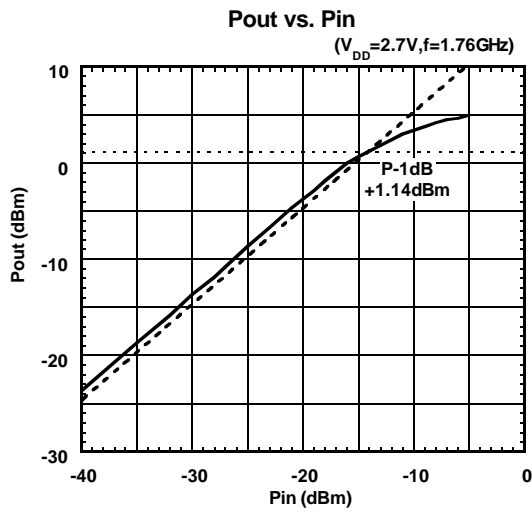
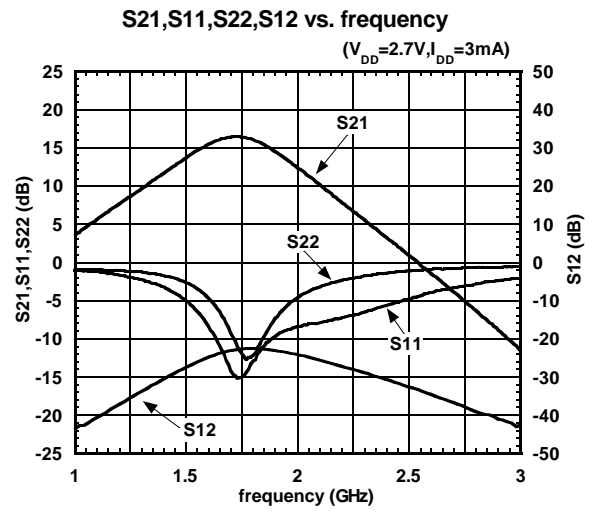
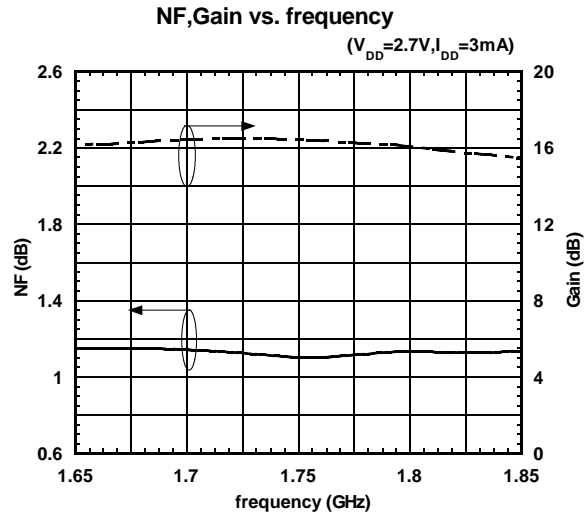

# NJG1107KB2

## ■ TYPICAL CHARACTERISTICS (1.8GHz Band)

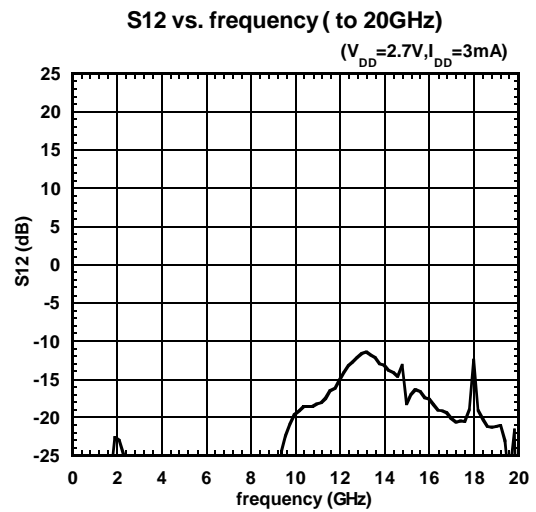
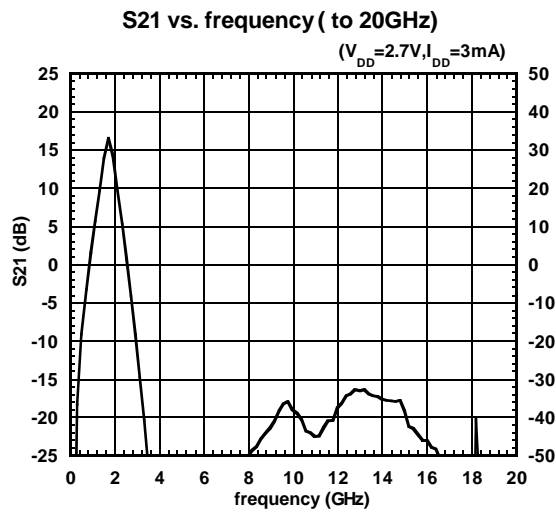
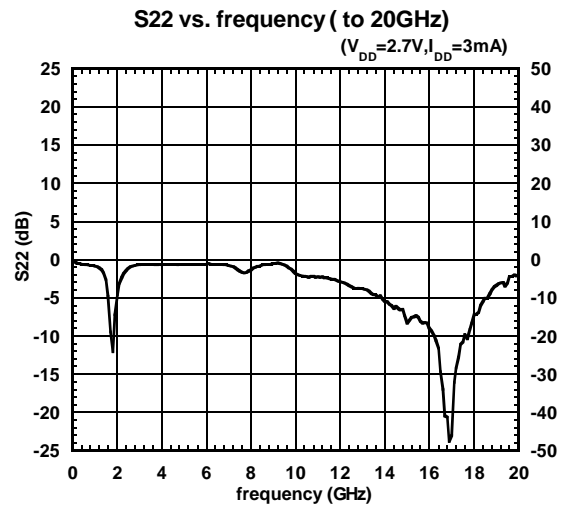
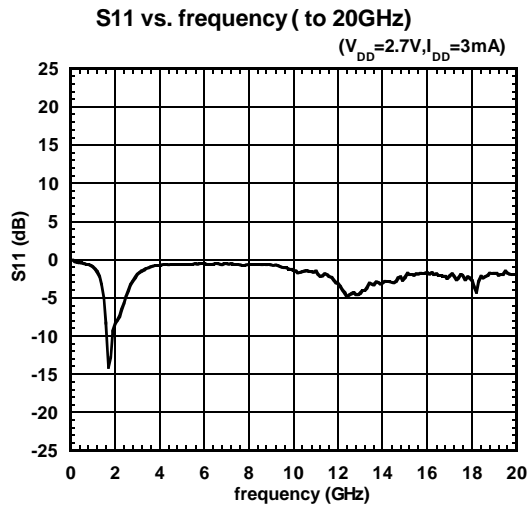

## TYPICAL CHARACTERISTICS (1.5GHz Band, Low Gain Version)

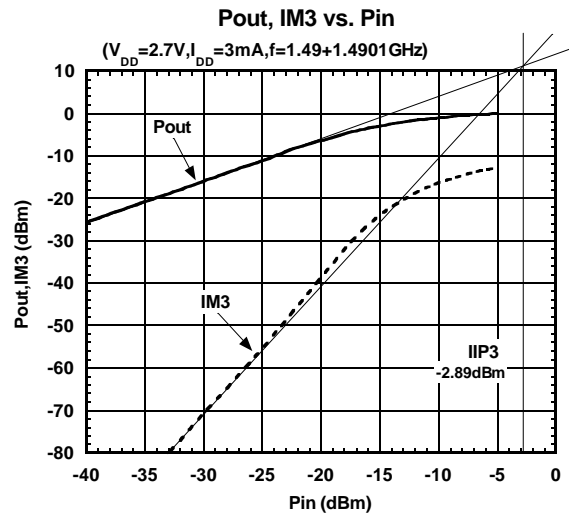
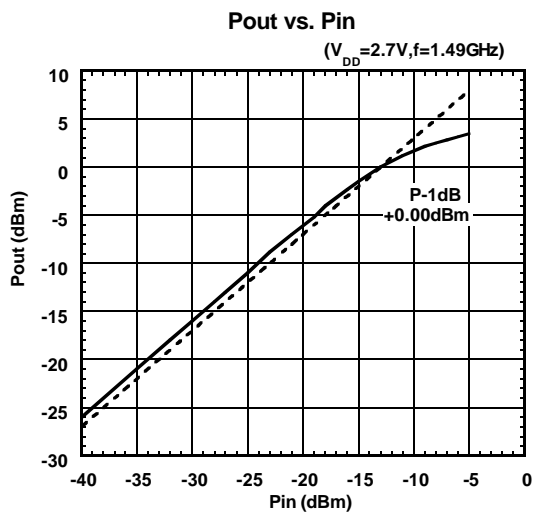
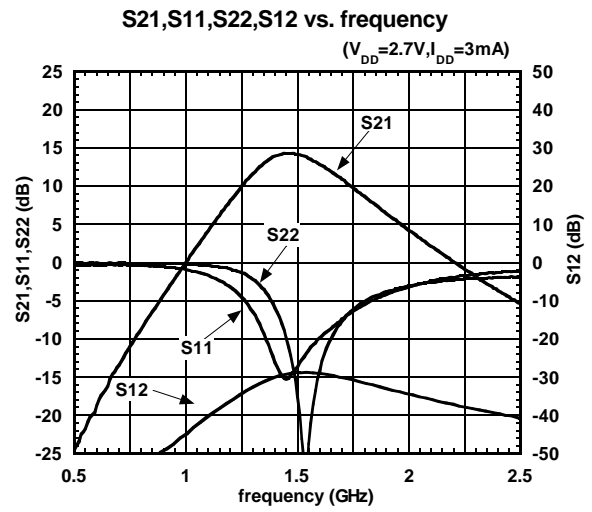
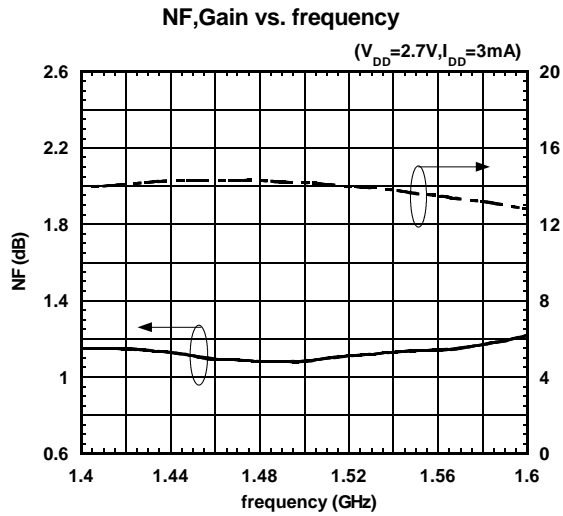

## ■ TYPICAL CHARACTERISTICS (1.5GHz Band, Low Gain Version)

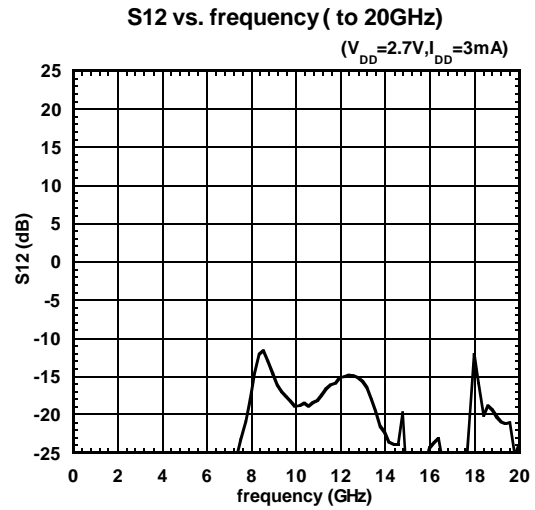
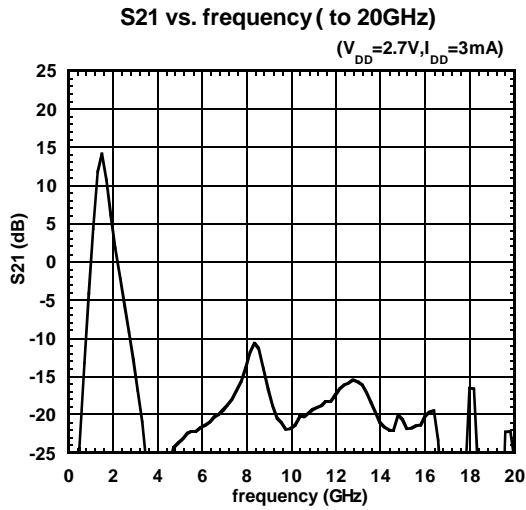
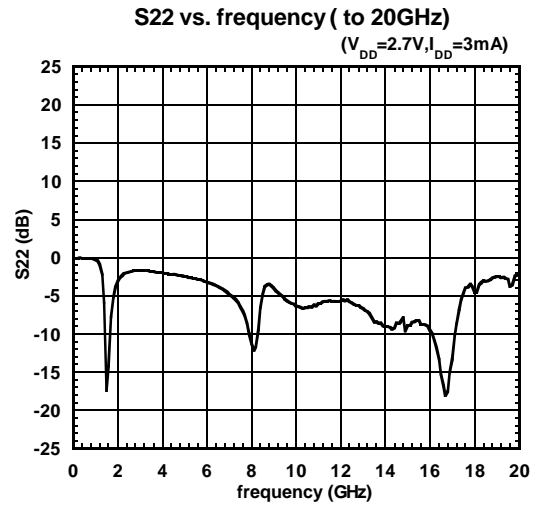
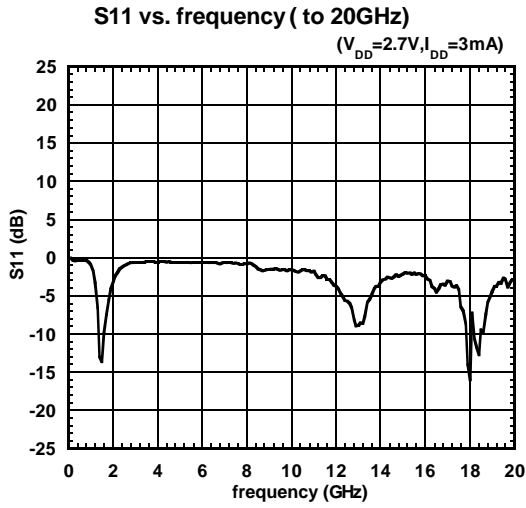

## ■TYPICAL CHARACTERISTICS

Scattering Parameter Table

$V_{DD}=2.7V, I_{DD}=3mA, Z_0=50\Omega$

Freq (GHz)	S11		S21		S12		S22	
	mag (units)	ang (deg)	mag (units)	ang (deg)	mag (units)	ang (deg)	mag (units)	ang (deg)
0.1	1.000	-3.130	2.094	176.987	0.012	-25.995	0.965	-1.855
0.2	0.986	-4.217	2.074	171.002	0.002	110.707	0.967	-1.782
0.3	0.986	-6.161	2.046	165.318	0.007	92.945	0.962	-3.088
0.4	0.972	-8.026	2.012	159.545	0.003	62.606	0.960	-3.801
0.5	0.965	-10.209	1.991	153.712	0.005	103.324	0.961	-5.113
0.6	0.957	-12.032	1.943	147.933	0.004	96.002	0.953	-6.159
0.7	0.943	-13.490	1.909	143.180	0.005	75.842	0.949	-7.623
0.8	0.929	-15.249	1.851	138.232	0.008	90.203	0.940	-9.144
0.9	0.910	-16.014	1.793	133.807	0.006	93.660	0.931	-9.943
1.0	0.903	-16.960	1.765	129.856	0.009	85.810	0.928	-10.876
1.1	0.894	-18.131	1.710	125.443	0.009	95.094	0.931	-12.170
1.2	0.879	-18.645	1.673	121.935	0.010	92.781	0.921	-13.089
1.3	0.864	-19.500	1.636	118.442	0.011	91.381	0.919	-14.156
1.4	0.852	-21.338	1.627	114.415	0.012	100.617	0.919	-14.843
1.5	0.843	-22.810	1.578	110.659	0.014	99.522	0.918	-16.259
1.6	0.826	-24.483	1.541	107.013	0.014	99.175	0.914	-17.088
1.7	0.818	-24.447	1.513	104.077	0.015	100.001	0.918	-18.228
1.8	0.810	-26.509	1.503	100.734	0.016	103.271	0.925	-19.508
1.9	0.801	-27.539	1.489	97.286	0.018	106.687	0.920	-20.507
2.0	0.794	-29.642	1.452	93.725	0.019	108.548	0.921	-21.024
2.1	0.783	-30.807	1.453	90.359	0.020	106.305	0.924	-22.491
2.2	0.782	-33.473	1.421	86.597	0.022	107.071	0.922	-24.160
2.3	0.770	-34.972	1.426	83.223	0.022	107.349	0.920	-25.779
2.4	0.772	-35.870	1.391	79.970	0.026	109.866	0.919	-27.462
2.5	0.760	-37.091	1.397	76.578	0.027	112.983	0.914	-29.724
2.6	0.761	-38.975	1.376	73.069	0.030	109.600	0.920	-32.086
2.7	0.757	-40.916	1.359	68.921	0.031	106.376	0.907	-35.211
2.8	0.756	-41.260	1.322	65.450	0.034	109.318	0.902	-38.255
2.9	0.757	-42.651	1.294	62.030	0.035	106.983	0.893	-41.787
3.0	0.752	-42.892	1.267	58.521	0.036	108.989	0.879	-45.326

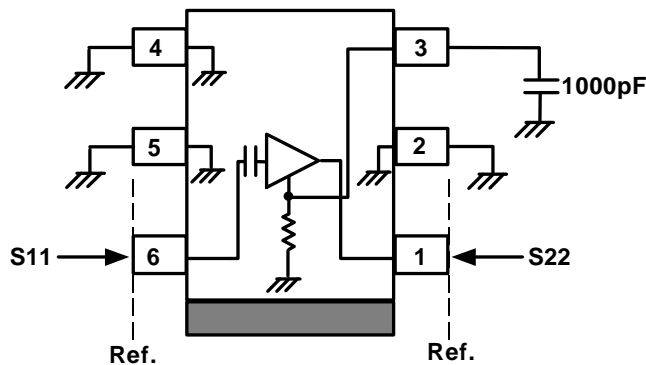

Scattering Parameter  
Measurement Circuit

*New Japan Radio Co., Ltd.*

# NJG1107KB2

## ■TYPICAL CHARACTERISTICS (1.5GHz Band, Low Gain Version)

Scattering Parameter Table

$V_{DD}=2.7V$ ,  $I_{DD}=3mA$ ,  $Z_0=50\Omega$

Freq (GHz)	S11		S21		S12		S22	
	mag (units)	ang (deg)	mag (units)	ang (deg)	mag (units)	ang (deg)	mag (units)	ang (deg)
0.1	1.011	-1.815	0.619	-137.421	0.006	150.071	0.998	-1.269
0.2	1.023	-4.177	1.049	-141.929	0.005	111.664	0.996	-3.638
0.3	1.027	-6.876	1.402	-152.156	0.004	72.732	0.999	-4.808
0.4	1.036	-10.171	1.681	-164.509	0.008	71.899	0.995	-6.754
0.5	1.029	-13.604	1.843	-176.486	0.006	80.582	0.993	-8.514
0.6	1.027	-17.041	1.967	-172.550	0.006	96.630	0.982	-9.913
0.7	1.007	-20.090	1.997	-162.037	0.010	79.136	0.983	-12.453
0.8	0.996	-22.496	1.994	-153.204	0.009	78.039	0.976	-14.051
0.9	0.978	-25.098	1.967	-144.936	0.009	80.635	0.967	-15.603
1.0	0.961	-27.178	1.925	-137.106	0.008	73.136	0.967	-17.199
1.1	0.940	-28.800	1.857	-131.070	0.010	71.678	0.961	-17.813
1.2	0.923	-30.761	1.825	-124.735	0.012	76.438	0.954	-19.024
1.3	0.905	-32.462	1.785	-118.431	0.011	77.174	0.948	-21.016
1.4	0.889	-33.815	1.719	-113.194	0.010	78.254	0.946	-22.555
1.5	0.877	-34.976	1.679	-107.647	0.014	83.456	0.947	-24.779
1.6	0.860	-36.777	1.610	-102.741	0.014	73.747	0.947	-26.267
1.7	0.849	-37.774	1.568	-98.621	0.014	80.053	0.942	-27.354
1.8	0.834	-39.260	1.534	-94.075	0.015	85.009	0.938	-28.669
1.9	0.822	-40.858	1.490	-89.890	0.015	83.753	0.939	-29.677
2.0	0.814	-42.312	1.464	-85.613	0.017	88.727	0.939	-31.456
2.1	0.801	-43.887	1.435	-81.588	0.017	92.695	0.938	-32.776
2.2	0.791	-45.820	1.393	-77.520	0.021	98.708	0.939	-34.232
2.3	0.784	-47.584	1.365	-73.663	0.019	95.532	0.936	-35.915
2.4	0.773	-49.825	1.332	-69.756	0.021	93.049	0.937	-36.454
2.5	0.766	-51.948	1.311	-66.211	0.024	93.358	0.940	-38.089
2.6	0.756	-54.101	1.285	-62.518	0.025	97.398	0.942	-39.619
2.7	0.753	-56.479	1.260	-58.997	0.028	99.809	0.946	-40.798
2.8	0.748	-59.220	1.229	-55.237	0.029	93.593	0.949	-42.180
2.9	0.745	-61.715	1.213	-51.930	0.031	100.273	0.947	-43.117
3.0	0.744	-64.848	1.189	-48.547	0.031	97.032	0.950	-44.659

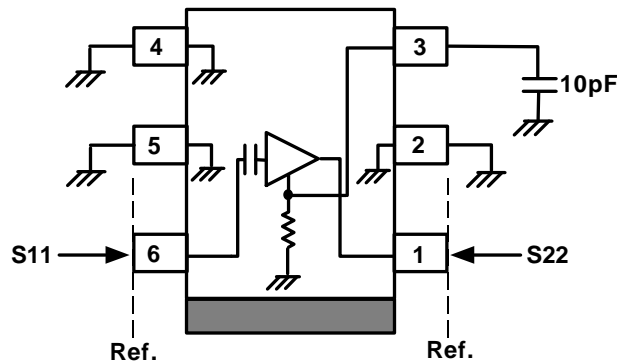

Scattering Parameter  
Measurement Circuit

*New Japan Radio Co., Ltd.*



## TEST CIRCUIT 1 (1.5/1.8/1.9GHz Band)

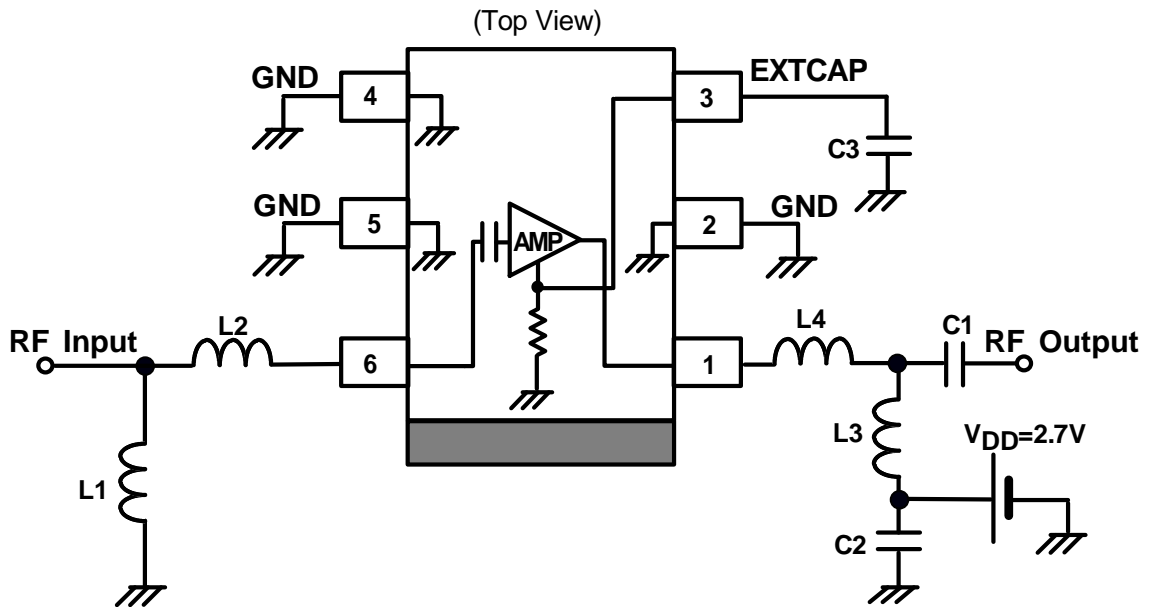

## TEST CIRCUIT 2 (1.5GHz Band, Low Gain Version)

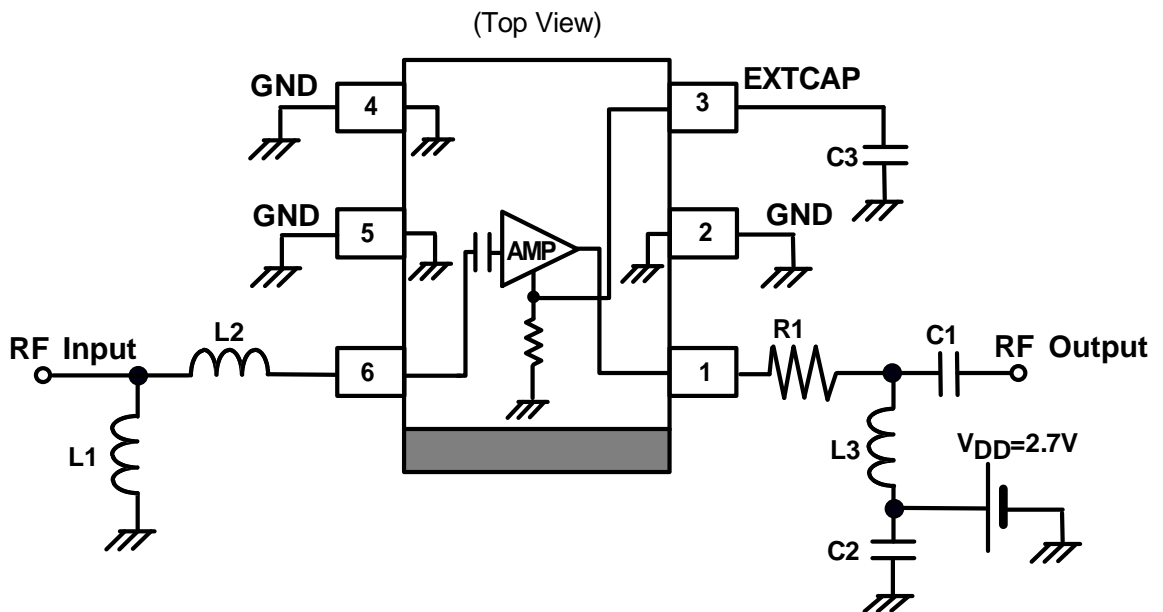



## PACKAGE OUTLINE (FLP6-B2)

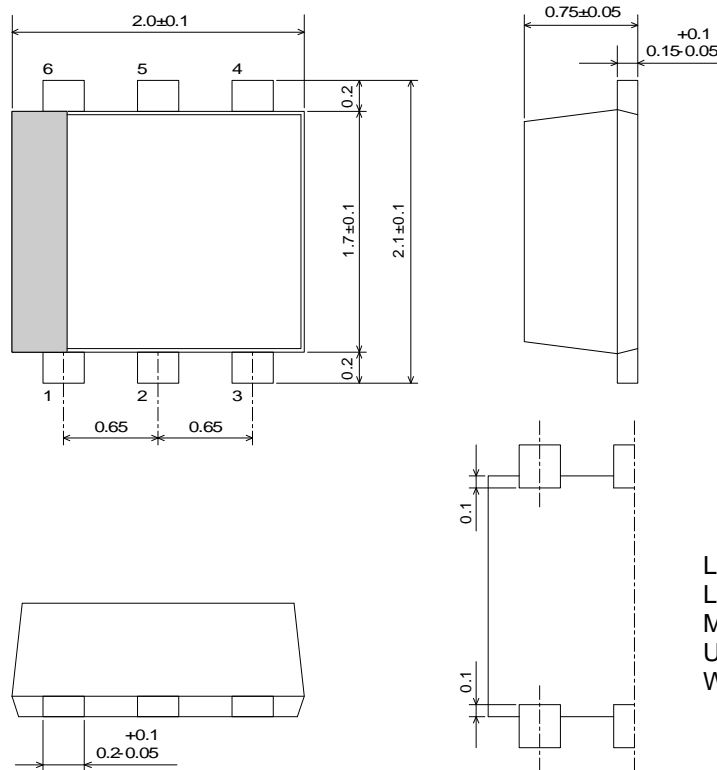

Lead material : Copper  
 Lead surface finish : Solder plating  
 Molding material : Epoxy resin  
 UNIT : mm  
 Weight : 6.5mg

### Cautions on using this product

This product contains Gallium-Arsenide (GaAs) which is a harmful material.

- Do NOT eat or put into mouth.
- Do NOT dispose in fire or break up this product.
- Do NOT chemically make gas or powder with this product.
- To waste this product, please obey the relating law of your country.

### [CAUTION]

The specifications on this databook are only given for information, without any guarantee as regards either mistakes or omissions. The application circuits in this databook are described only to show representative usages of the product and not intended for the guarantee or permission of any right including the industrial rights.

This product may be damaged with electric static discharge (ESD) or spike voltage. Please handle with care to avoid these damages.