

EVALUATION KIT  
AVAILABLE

# MAXIM

## DC-to-Microwave, +5V Low-Noise Amplifier

MAX2650

### General Description

The MAX2650 is a low-noise amplifier for use from DC to microwave frequencies. Operating from a single +5V supply, it has a flat gain response to 900MHz. The MAX2650's low noise figure and high drive capability make it ideal for a variety of transmit, receive, and buffer applications.

The device is internally biased, eliminating the need for external bias resistors or inductors. In a typical application, the only external components needed are input and output blocking capacitors and a VCC bypass capacitor.

The MAX2650 comes in a 4-pin SOT143 package, requiring minimal board space.

### Applications

Wireless Local Loop  
Global Positioning Systems (GPS)  
ISM Radios  
Special Mobile Radios  
Wireless Local-Area Networks  
Cellular Base Stations  
Set-Top Boxes

### Features

- ◆ Internally Biased
- ◆ High Gain: 18.3dB at 900MHz
- ◆ 3.9dB Noise Figure
- ◆ Single +4.5V to +5.5V Operation
- ◆ -1dBm Output 1dB Compression Power
- ◆ Low-Cost Silicon Bipolar Design
- ◆ Ultra-Small SOT143 Package

### Ordering Information

PART	TEMP RANGE	PIN-PACKAGE
MAX2650EUS-T	-40°C to +85°C	4 SOT143-4

### Typical Operating Circuit

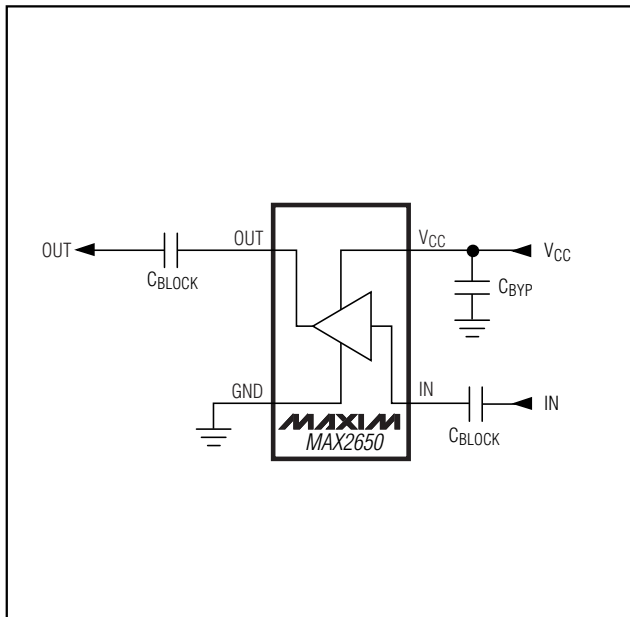

### Pin Configuration

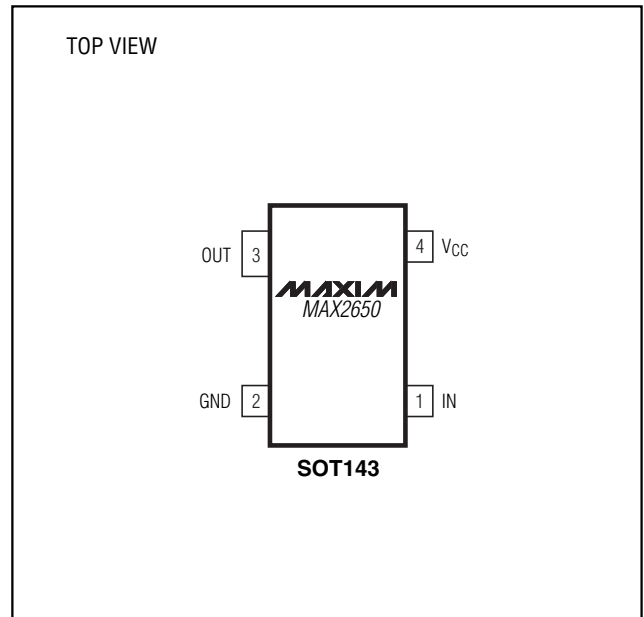

MAXIM

Maxim Integrated Products 1

**For pricing, delivery, and ordering information, please contact Maxim/Dallas Direct! at 1-888-629-4642, or visit Maxim's website at [www.maxim-ic.com](http://www.maxim-ic.com).**

# DC-to-Microwave, +5V Low-Noise Amplifier

## ABSOLUTE MAXIMUM RATINGS

V <sub>CC</sub> to GND .....	-0.3V to +8V	Operating Temperature Range .....	-40°C to +85°C
Input Power .....	+13dBm	Junction Temperature .....	+150°C
Continuous Power Dissipation (T <sub>A</sub> = +70°C)		Storage Temperature Range .....	-65°C to +150°C
SOT143-4 (derate 4mW/°C above +70°C).....	320mW	Lead Temperature (soldering, 10s) .....	+300°C

Stresses beyond those listed under "Absolute Maximum Ratings" may cause permanent damage to the device. These are stress ratings only, and functional operation of the device at these or any other conditions beyond those indicated in the operational sections of the specifications is not implied. Exposure to absolute maximum rating conditions for extended periods may affect device reliability.



**CAUTION!** ESD SENSITIVE DEVICE

## ELECTRICAL CHARACTERISTICS

(V<sub>CC</sub> = +5.0V, Z<sub>0</sub> = 50Ω, f<sub>IN</sub> = 900MHz, T<sub>A</sub> = +25°C, unless otherwise noted.)

PARAMETER	CONDITIONS	MIN	TYP	MAX	UNITS
Operating Temperature Range	(Note 1)	-40		85	°C
Power Gain		16.5	18.3	21	dB
Output 1dB Compression Point			-1		dBm
Output IP3			10		dBm
Noise Figure			3.9		dB
Maximum Input Voltage Standing-Wave Ratio	f <sub>IN</sub> = 100MHz to 1000MHz		1.5:1		
Maximum Output Voltage Standing-Wave Ratio	f <sub>IN</sub> = 800MHz to 1000MHz		1.3:1		
Group Delay			300		ps
Supply Voltage		4.5		5.5	V
Supply Current		15.5	17.7	20.0	mA
	T <sub>A</sub> = T <sub>MIN</sub> to T <sub>MAX</sub>	13.0	17.7	22.0	
	V <sub>CC</sub> = 4.5V to 5.5V	11.0	17.7	24.0	

**Note 1:** Parts are designed to operate over specified temperature range. Specifications are production tested and guaranteed at +25°C.

# DC-to-Microwave, +5V Low-Noise Amplifier

## Typical Operating Characteristics

( $V_{CC} = 5.0V$ ,  $Z_0 = 50\Omega$ ,  $f_{IN} = 900MHz$ ,  $T_A = +25^\circ C$ , unless otherwise noted.)

MAX2650

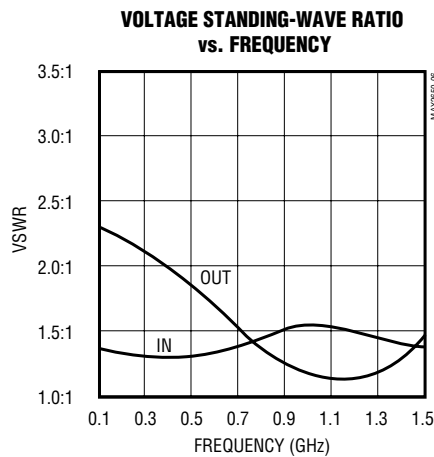
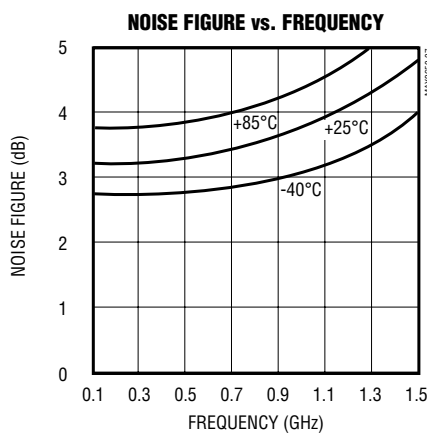
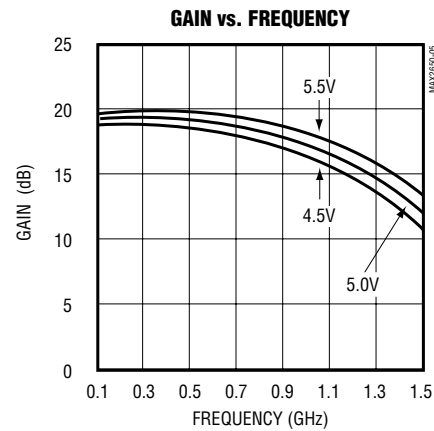
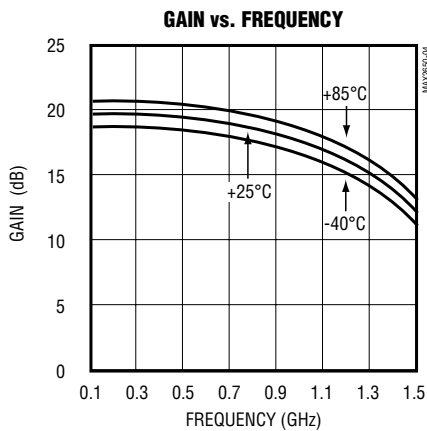
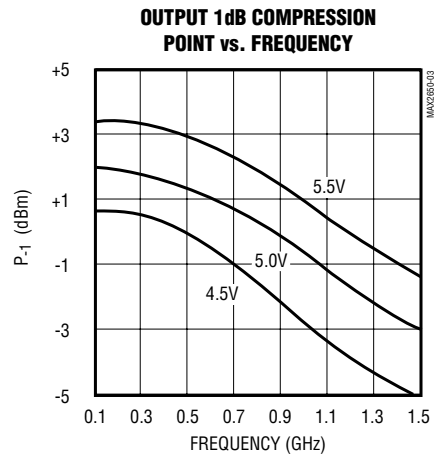
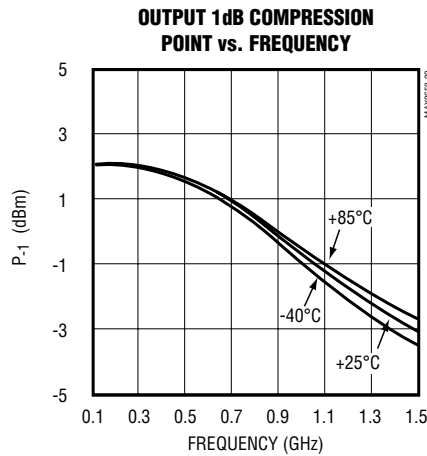
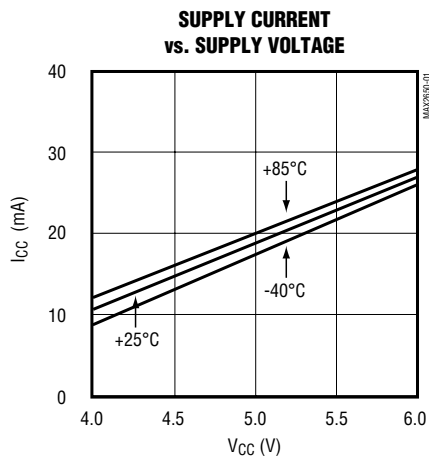

# DC-to-Microwave, +5V Low-Noise Amplifier

## Pin Description

PIN	NAME	FUNCTION
1	IN	Amplifier Input. Use a series blocking capacitor with less than 3Ω reactance at your lowest operating frequency.
2	GND	Ground Connection. For optimum performance, provide a low-inductance connection to the ground plane.
3	OUT	Amplifier Output. Use a series blocking capacitor with less than 3Ω reactance at your lowest operating frequency.
4	VCC	Supply Connection. Bypass directly at the package pin. The value of the bypass capacitor is determined by the lowest operating frequency and is typically the same as the blocking capacitor value. For long VCC lines, additional bypassing may be necessary.

**Table 1. Typical Scattering Parameters**

(VCC = +5V, Z0 = 50Ω, TA = +25°C.)

FREQUENCY (GHz)	S11 (mag)	S11 (ang)	S21 (dB)	S21 (mag)	S21 (ang)	S12 (dB)	S12 (mag)	S12 (ang)	S22 (mag)	S22 (ang)	K
0.05	0.17	-3	19.8	9.76	177	-37.8	0.013	8	0.42	-5	3.18
0.10	0.17	-6	19.8	9.72	172	-36.7	0.015	14	0.39	-6	2.92
0.20	0.16	9	19.7	9.69	161	-35.8	0.016	23	0.37	-13	2.70
0.30	0.14	8	19.7	9.70	151	-35.0	0.018	28	0.35	-19	2.54
0.40	0.16	0	19.6	9.52	140	-33.8	0.020	32	0.32	-26	2.31
0.50	0.16	-7	19.5	9.43	129	-33.2	0.022	34	0.28	-34	2.24
0.60	0.17	-17	19.3	9.21	119	-32.3	0.024	37	0.25	-43	2.12
0.70	0.18	-26	19.0	8.93	107	-31.7	0.026	41	0.21	-53	2.09
0.80	0.18	-39	18.6	8.46	95	-31.1	0.028	44	0.17	-62	2.10
0.90	0.20	-54	18.0	7.92	84	-29.5	0.033	48	0.13	-71	1.91
1.00	0.20	-66	17.4	7.40	73	-28.7	0.037	50	0.10	-76	1.88
1.20	0.19	-86	15.7	6.10	51	-26.9	0.045	52	0.05	-49	1.88
1.40	0.16	-86	13.4	4.69	31	-25.5	0.053	51	0.12	-12	2.03
1.60	0.15	-66	10.6	3.40	14	-24.4	0.060	44	0.24	-17	2.32
1.80	0.22	-40	7.4	2.35	5	-24.4	0.060	32	0.35	-27	3.01
2.00	0.33	-36	4.6	1.70	4	-25.3	0.055	22	0.43	-33	3.97
2.20	0.41	-38	3.1	1.43	6	-26.5	0.047	21	0.46	-33	4.85
2.40	0.44	-37	2.5	1.34	6	-28.6	0.037	22	0.49	-29	6.26
2.50	0.44	-37	2.3	1.30	4	-29.5	0.034	22	0.49	-25	7.05

# DC-to-Microwave, +5V Low-Noise Amplifier

MAX2650

## Detailed Description

The MAX2650 is a broadband amplifier with flat gain and 50Ω input and output ports. Its small size and internal bias circuitry make it ideal for applications where board space is limited.

## Applications Information

### External Components

As shown in the *Typical Operating Circuit*, the MAX2650 is easy to use. Input and output series capacitors may be necessary to block DC bias voltages (generated by the MAX2650) from interacting with adjacent circuitry. These capacitors must be large enough to contribute negligible reactance in a 50Ω system at the minimum operating frequency. Use the following equation to calculate their minimum value:

$$C_{\text{BLOCK}} = \frac{53,000}{f} \text{ (pF)}$$

where  $f$  (in MHz) is the minimum operating frequency.

The VCC pin must be RF bypassed for correct operation. To accomplish this, connect a capacitor between the VCC pin and ground, as close to the package as is practical. Use the same equation given above (for DC blocking capacitor values) to calculate the minimum capacitor value. If there are long VCC lines on the PC board, additional bypassing may be necessary. This may be done further away from the package, at your discretion.

Proper grounding of the GND pin is essential. If the PC board uses a topside RF ground, the GND pin should connect directly to it. For a board where the ground plane is not on the component side, the best technique is to connect the GND pin to it through multiple plated through-holes.

### PC Board Layout Example

An example PC board layout is given in Figure 1. It uses FR-4 with 31mil layer thickness between the RF lines and the ground plane. The board satisfies all the above requirements.

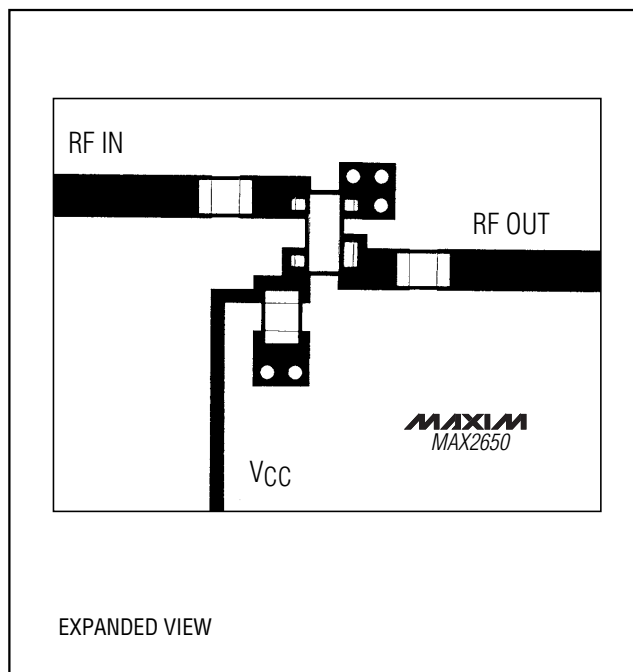
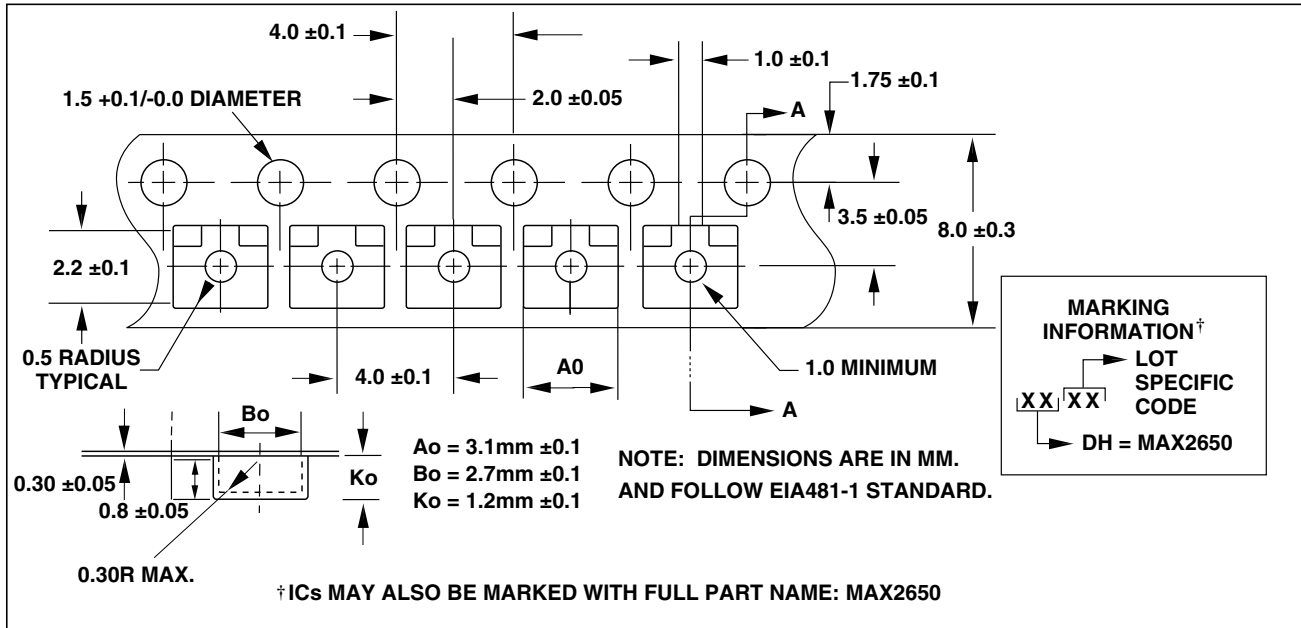

Figure 1. Example PC Board Layout

# DC-to-Microwave, +5V Low-Noise Amplifier +5V Low-Noise Amplifier

## Tape-and-Reel/Marking Information



## Package Information

(The package drawing(s) in this data sheet may not reflect the most current specifications. For the latest package outline information, go to [www.maxim-ic.com/packages](http://www.maxim-ic.com/packages).)

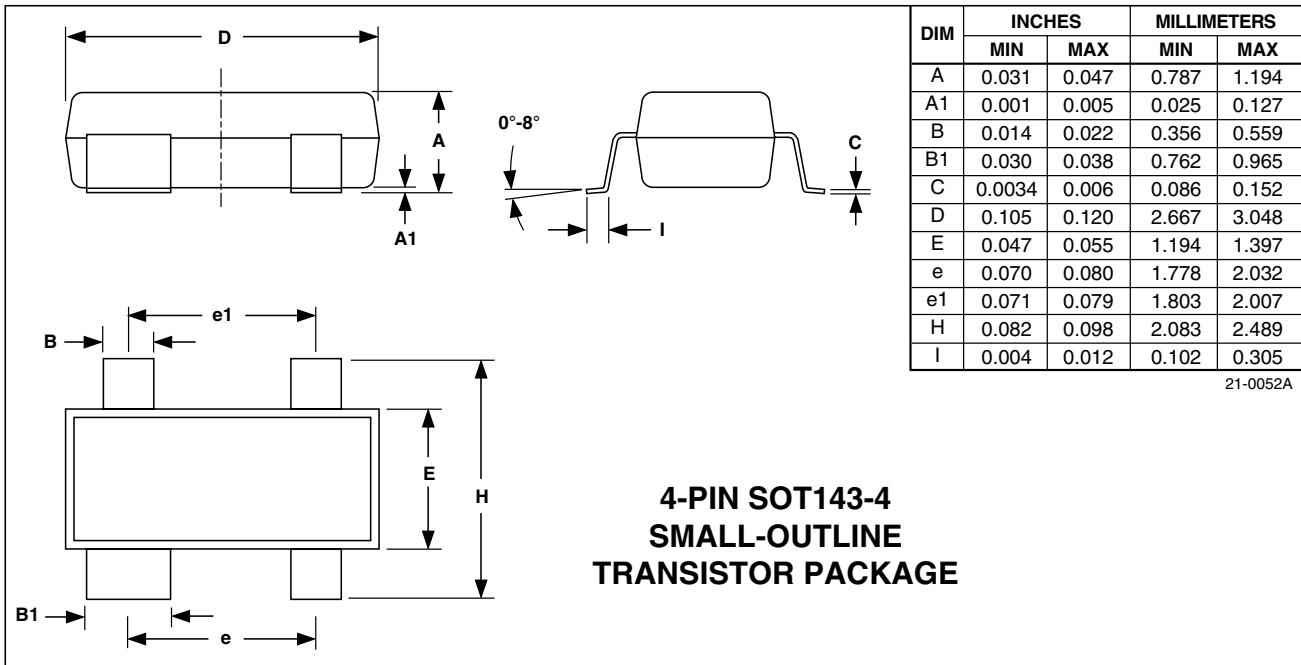

Maxim cannot assume responsibility for use of any circuitry other than circuitry entirely embodied in a Maxim product. No circuit patent licenses are implied. Maxim reserves the right to change the circuitry and specifications without notice at any time.

6 Maxim Integrated Products, 120 San Gabriel Drive, Sunnyvale, CA 94086 (408) 737-7600